

ALAN JEFFREY • HUI-HUI DAI

HANDBOOK OF MATHEMATICAL FORMULAS AND INTEGRALS

4th
Edition



$$\frac{\partial u}{\partial t} + u \frac{\partial u}{\partial x} - v \frac{\partial^2 u}{\partial x^2} + \mu \frac{\partial^3 u}{\partial x^3} = 0 \quad [v > 0]$$

Handbook of
Mathematical Formulas and Integrals

FOURTH EDITION

Handbook of Mathematical Formulas and Integrals

FOURTH EDITION

Alan Jeffrey

Professor of Engineering Mathematics
University of Newcastle upon Tyne
Newcastle upon Tyne
United Kingdom

Hui-Hui Dai

Associate Professor of Mathematics
City University of Hong Kong
Kowloon, China



ELSEVIER

AMSTERDAM • BOSTON • HEIDELBERG • LONDON
NEW YORK • OXFORD • PARIS • SAN DIEGO
SAN FRANCISCO • SINGAPORE • SYDNEY • TOKYO

Academic Press is an imprint of Elsevier



Acquisitions Editor: Lauren Schultz Yuhasz
Developmental Editor: Mara Vos-Sarmiento
Marketing Manager: Leah Ackerson
Cover Design: Alisa Andreola
Cover Illustration: Dick Hannus
Production Project Manager: Sarah M. Hajduk
Composer: diacriTech
Cover Printer: Phoenix Color
Printer: Sheridan Books

Academic Press is an imprint of Elsevier
30 Corporate Drive, Suite 400, Burlington, MA 01803, USA
525 B Street, Suite 1900, San Diego, California 92101-4495, USA
84 Theobald's Road, London WC1X 8RR, UK

This book is printed on acid-free paper. ∞

Copyright © 2008, Elsevier Inc. All rights reserved.

No part of this publication may be reproduced or transmitted in any form or by any means, electronic or mechanical, including photocopy, recording, or any information storage and retrieval system, without permission in writing from the publisher.

Permissions may be sought directly from Elsevier's Science & Technology Rights Department in Oxford, UK: phone: (+44) 1865 843830, fax: (+44) 1865 853333, E-mail: permissions@elsevier.com. You may also complete your request online via the Elsevier homepage (<http://elsevier.com>), by selecting "Support & Contact" then "Copyright and Permission" and then "Obtaining Permissions."

Library of Congress Cataloging-in-Publication Data
Application Submitted

British Library Cataloguing-in-Publication Data
A catalogue record for this book is available from the British Library.

ISBN: 978-0-12-374288-9

For information on all Academic Press publications
visit our Web site at www.books.elsevier.com

Printed in the United States of America
08 09 10 9 8 7 6 5 4 3 2 1

Working together to grow
libraries in developing countries

www.elsevier.com | www.bookaid.org | www.sabre.org

ELSEVIER

BOOK AID
International

Sabre Foundation

Contents

Preface	xix
Preface to the Fourth Edition	xxi
Notes for Handbook Users	xxiii
Index of Special Functions and Notations	xliii
0 Quick Reference List of Frequently Used Data	1
0.1. Useful Identities	1
0.1.1. Trigonometric Identities	1
0.1.2. Hyperbolic Identities	2
0.2. Complex Relationships	2
0.3. Constants, Binomial Coefficients and the Pochhammer Symbol	3
0.4. Derivatives of Elementary Functions	3
0.5. Rules of Differentiation and Integration	4
0.6. Standard Integrals	4
0.7. Standard Series	10
0.8. Geometry	12
1 Numerical, Algebraic, and Analytical Results for Series and Calculus	27
1.1. Algebraic Results Involving Real and Complex Numbers	27
1.1.1. Complex Numbers	27
1.1.2. Algebraic Inequalities Involving Real and Complex Numbers	28
1.2. Finite Sums	32
1.2.1. The Binomial Theorem for Positive Integral Exponents	32
1.2.2. Arithmetic, Geometric, and Arithmetic–Geometric Series	36
1.2.3. Sums of Powers of Integers	36
1.2.4. Proof by Mathematical Induction	38
1.3. Bernoulli and Euler Numbers and Polynomials	40
1.3.1. Bernoulli and Euler Numbers	40
1.3.2. Bernoulli and Euler Polynomials	46
1.3.3. The Euler–Maclaurin Summation Formula	48
1.3.4. Accelerating the Convergence of Alternating Series	49
1.4. Determinants	50
1.4.1. Expansion of Second- and Third-Order Determinants	50
1.4.2. Minors, Cofactors, and the Laplace Expansion	51
1.4.3. Basic Properties of Determinants	53

1.4.4.	Jacobi's Theorem	53
1.4.5.	Hadamard's Theorem	54
1.4.6.	Hadamard's Inequality	54
1.4.7.	Cramer's Rule	55
1.4.8.	Some Special Determinants	55
1.4.9.	Routh–Hurwitz Theorem	57
1.5.	Matrices	58
1.5.1.	Special Matrices	58
1.5.2.	Quadratic Forms	62
1.5.3.	Differentiation and Integration of Matrices	64
1.5.4.	The Matrix Exponential	65
1.5.5.	The Gerschgorin Circle Theorem	67
1.6.	Permutations and Combinations	67
1.6.1.	Permutations	67
1.6.2.	Combinations	68
1.7.	Partial Fraction Decomposition	68
1.7.1.	Rational Functions	68
1.7.2.	Method of Undetermined Coefficients	69
1.8.	Convergence of Series	72
1.8.1.	Types of Convergence of Numerical Series	72
1.8.2.	Convergence Tests	72
1.8.3.	Examples of Infinite Numerical Series	74
1.9.	Infinite Products	77
1.9.1.	Convergence of Infinite Products	77
1.9.2.	Examples of Infinite Products	78
1.10.	Functional Series	79
1.10.1.	Uniform Convergence	79
1.11.	Power Series	82
1.11.1.	Definition	82
1.12.	Taylor Series	86
1.12.1.	Definition and Forms of Remainder Term	86
1.12.2.	Order Notation (Big O and Little o)	88
1.13.	Fourier Series	89
1.13.1.	Definitions	89
1.14.	Asymptotic Expansions	93
1.14.1.	Introduction	93
1.14.2.	Definition and Properties of Asymptotic Series	94
1.15.	Basic Results from the Calculus	95
1.15.1.	Rules for Differentiation	95
1.15.2.	Integration	96
1.15.3.	Reduction Formulas	99
1.15.4.	Improper Integrals	101
1.15.5.	Integration of Rational Functions	103
1.15.6.	Elementary Applications of Definite Integrals	104

2	Functions and Identities	109
2.1.	Complex Numbers and Trigonometric and Hyperbolic Functions	109
2.1.1.	Basic Results	109
2.2.	Logarithms and Exponentials	121
2.2.1.	Basic Functional Relationships	121
2.2.2.	The Number e	123
2.3.	The Exponential Function	123
2.3.1.	Series Representations	123
2.4.	Trigonometric Identities	124
2.4.1.	Trigonometric Functions	124
2.5.	Hyperbolic Identities	132
2.5.1.	Hyperbolic Functions	132
2.6.	The Logarithm	137
2.6.1.	Series Representations	137
2.7.	Inverse Trigonometric and Hyperbolic Functions	139
2.7.1.	Domains of Definition and Principal Values	139
2.7.2.	Functional Relations	139
2.8.	Series Representations of Trigonometric and Hyperbolic Functions	144
2.8.1.	Trigonometric Functions	144
2.8.2.	Hyperbolic Functions	145
2.8.3.	Inverse Trigonometric Functions	146
2.8.4.	Inverse Hyperbolic Functions	146
2.9.	Useful Limiting Values and Inequalities Involving Elementary Functions	147
2.9.1.	Logarithmic Functions	147
2.9.2.	Exponential Functions	147
2.9.3.	Trigonometric and Hyperbolic Functions	148
3	Derivatives of Elementary Functions	149
3.1.	Derivatives of Algebraic, Logarithmic, and Exponential Functions	149
3.2.	Derivatives of Trigonometric Functions	150
3.3.	Derivatives of Inverse Trigonometric Functions	150
3.4.	Derivatives of Hyperbolic Functions	151
3.5.	Derivatives of Inverse Hyperbolic Functions	152
4	Indefinite Integrals of Algebraic Functions	153
4.1.	Algebraic and Transcendental Functions	153
4.1.1.	Definitions	153
4.2.	Indefinite Integrals of Rational Functions	154
4.2.1.	Integrands Involving x^n	154
4.2.2.	Integrands Involving $a + bx$	154
4.2.3.	Integrands Involving Linear Factors	157
4.2.4.	Integrands Involving $a^2 \pm b^2x^2$	158
4.2.5.	Integrands Involving $a + bx + cx^2$	162

4.2.6.	Integrands Involving $a + bx^3$	164
4.2.7.	Integrands Involving $a + bx^4$	165
4.3.	Nonrational Algebraic Functions	166
4.3.1.	Integrands Containing $a + bx^k$ and \sqrt{x}	166
4.3.2.	Integrands Containing $(a + bx)^{1/2}$	168
4.3.3.	Integrands Containing $(a + cx^2)^{1/2}$	170
4.3.4.	Integrands Containing $(a + bx + cx^2)^{1/2}$	172
5	Indefinite Integrals of Exponential Functions	175
5.1.	Basic Results	175
5.1.1.	Indefinite Integrals Involving e^{ax}	175
5.1.2.	Integrals Involving the Exponential Functions Combined with Rational Functions of x	175
5.1.3.	Integrands Involving the Exponential Functions Combined with Trigonometric Functions	177
6	Indefinite Integrals of Logarithmic Functions	181
6.1.	Combinations of Logarithms and Polynomials	181
6.1.1.	The Logarithm	181
6.1.2.	Integrands Involving Combinations of $\ln(ax)$ and Powers of x	182
6.1.3.	Integrands Involving $(a + bx)^m \ln^n x$	183
6.1.4.	Integrands Involving $\ln(x^2 \pm a^2)$	185
6.1.5.	Integrands Involving $x^m \ln \left[x + (x^2 \pm a^2)^{1/2} \right]$	186
7	Indefinite Integrals of Hyperbolic Functions	189
7.1.	Basic Results	189
7.1.1.	Integrands Involving $\sinh(a + bx)$ and $\cosh(a + bx)$	189
7.2.	Integrands Involving Powers of $\sinh(bx)$ or $\cosh(bx)$	190
7.2.1.	Integrands Involving Powers of $\sinh(bx)$	190
7.2.2.	Integrands Involving Powers of $\cosh(bx)$	190
7.3.	Integrands Involving $(a + bx)^m \sinh(cx)$ or $(a + bx)^m \cosh(cx)$	191
7.3.1.	General Results	191
7.4.	Integrands Involving $x^m \sinh^n x$ or $x^m \cosh^n x$	193
7.4.1.	Integrands Involving $x^m \sinh^n x$	193
7.4.2.	Integrands Involving $x^m \cosh^n x$	193
7.5.	Integrands Involving $x^m \sinh^n x$ or $x^m \cosh^n x$	193
7.5.1.	Integrands Involving $x^m \sinh^n x$	193
7.5.2.	Integrands Involving $x^m \cosh^n x$	194
7.6.	Integrands Involving $(1 \pm \cosh x)^{-m}$	195
7.6.1.	Integrands Involving $(1 \pm \cosh x)^{-1}$	195
7.6.2.	Integrands Involving $(1 \pm \cosh x)^{-2}$	195

7.7.	Integrands Involving $\sinh(ax) \cosh^{-n} x$ or $\cosh(ax) \sinh^{-n} x$	195
7.7.1.	Integrands Involving $\sinh(ax) \cosh^n x$	195
7.7.2.	Integrands Involving $\cosh(ax) \sinh^n x$	196
7.8.	Integrands Involving $\sinh(ax + b)$ and $\cosh(cx + d)$	196
7.8.1.	General Case	196
7.8.2.	Special Case $a = c$	197
7.8.3.	Integrands Involving $\sinh^p x \cosh^q x$	197
7.9.	Integrands Involving $\tanh kx$ and $\coth kx$	198
7.9.1.	Integrands Involving $\tanh kx$	198
7.9.2.	Integrands Involving $\coth kx$	198
7.10.	Integrands Involving $(a + bx)^m \sinh kx$ or $(a + bx)^m \cosh kx$	199
7.10.1.	Integrands Involving $(a + bx)^m \sinh kx$	199
7.10.2.	Integrands Involving $(a + bx)^m \cosh kx$	199
8	Indefinite Integrals Involving Inverse Hyperbolic Functions	201
8.1.	Basic Results	201
8.1.1.	Integrands Involving Products of x^n and $\operatorname{arsinh}(x/a)$ or $\operatorname{arc}(x/c)$	201
8.2.	Integrands Involving $x^{-n} \operatorname{arsinh}(x/a)$ or $x^{-n} \operatorname{arcosh}(x/a)$	202
8.2.1.	Integrands Involving $x^{-n} \operatorname{arsinh}(x/a)$	202
8.2.2.	Integrands Involving $x^{-n} \operatorname{arcosh}(x/a)$	203
8.3.	Integrands Involving $x^n \operatorname{artanh}(x/a)$ or $x^n \operatorname{arcoth}(x/a)$	204
8.3.1.	Integrands Involving $x^n \operatorname{artanh}(x/a)$	204
8.3.2.	Integrands Involving $x^n \operatorname{arcoth}(x/a)$	204
8.4.	Integrands Involving $x^{-n} \operatorname{artanh}(x/a)$ or $x^{-n} \operatorname{arcoth}(x/a)$	205
8.4.1.	Integrands Involving $x^{-n} \operatorname{artanh}(x/a)$	205
8.4.2.	Integrands Involving $x^{-n} \operatorname{arcoth}(x/a)$	205
9	Indefinite Integrals of Trigonometric Functions	207
9.1.	Basic Results	207
9.1.1.	Simplification by Means of Substitutions	207
9.2.	Integrands Involving Powers of x and Powers of $\sin x$ or $\cos x$	209
9.2.1.	Integrands Involving $x^n \sin^m x$	209
9.2.2.	Integrands Involving $x^{-n} \sin^m x$	210
9.2.3.	Integrands Involving $x^n \sin^{-m} x$	211
9.2.4.	Integrands Involving $x^n \cos^m x$	212
9.2.5.	Integrands Involving $x^{-n} \cos^m x$	213
9.2.6.	Integrands Involving $x^n \cos^{-m} x$	213
9.2.7.	Integrands Involving $x^n \sin x / (a + b \cos x)^m$ or $x^n \cos x / (a + b \sin x)^m$	214
9.3.	Integrands Involving $\tan x$ and/or $\cot x$	215
9.3.1.	Integrands Involving $\tan^n x$ or $\tan^n x / (\tan x \pm 1)$	215
9.3.2.	Integrands Involving $\cot^n x$ or $\tan x$ and $\cot x$	216

9.4.	Integrands Involving $\sin x$ and $\cos x$	217
9.4.1.	Integrands Involving $\sin^m x \cos^n x$	217
9.4.2.	Integrands Involving $\sin^{-n} x$	217
9.4.3.	Integrands Involving $\cos^{-n} x$	218
9.4.4.	Integrands Involving $\sin^m x / \cos^n x \cos^m x / \sin^n x$	218
9.4.5.	Integrands Involving $\sin^{-m} x \cos^{-n} x$	220
9.5.	Integrands Involving Sines and Cosines with Linear Arguments and Powers of x	221
9.5.1.	Integrands Involving Products of $(ax + b)^n$, $\sin(cx + d)$, and/or $\cos(px + q)$	221
9.5.2.	Integrands Involving $x^n \sin^m x$ or $x^n \cos^m x$	222
10	Indefinite Integrals of Inverse Trigonometric Functions	225
10.1.	Integrands Involving Powers of x and Powers of Inverse Trigonometric Functions	225
10.1.1.	Integrands Involving $x^n \arcsin^m(x/a)$	225
10.1.2.	Integrands Involving $x^{-n} \arcsin(x/a)$	226
10.1.3.	Integrands Involving $x^n \arccos^m(x/a)$	226
10.1.4.	Integrands Involving $x^{-n} \arccos(x/a)$	227
10.1.5.	Integrands Involving $x^n \arctan(x/a)$	227
10.1.6.	Integrands Involving $x^{-n} \arctan(x/a)$	227
10.1.7.	Integrands Involving $x^n \operatorname{arccot}(x/a)$	228
10.1.8.	Integrands Involving $x^{-n} \operatorname{arccot}(x/a)$	228
10.1.9.	Integrands Involving Products of Rational Functions and $\operatorname{arccot}(x/a)$	229
11	The Gamma, Beta, Pi, and Psi Functions, and the Incomplete Gamma Functions	231
11.1.	The Euler Integral Limit and Infinite Product Representations for the Gamma Function $\Gamma(x)$. The Incomplete Gamma Functions $\Gamma(\alpha, x)$ and $\gamma(\alpha, x)$	231
11.1.1.	Definitions and Notation	231
11.1.2.	Special Properties of $\Gamma(x)$	232
11.1.3.	Asymptotic Representations of $\Gamma(x)$ and $n!$	233
11.1.4.	Special Values of $\Gamma(x)$	233
11.1.5.	The Gamma Function in the Complex Plane	233
11.1.6.	The Psi (Digamma) Function	234
11.1.7.	The Beta Function	235
11.1.8.	Graph of $\Gamma(x)$ and Tabular Values of $\Gamma(x)$ and $\ln \Gamma(x)$	235
11.1.9.	The Incomplete Gamma Function	236
12	Elliptic Integrals and Functions	241
12.1.	Elliptic Integrals	241
12.1.1.	Legendre Normal Forms	241

12.1.2.	Tabulations and Trigonometric Series Representations of Complete Elliptic Integrals	243
12.1.3.	Tabulations and Trigonometric Series for $E(\varphi, k)$ and $F(\varphi, k)$	245
12.2.	Jacobian Elliptic Functions	247
12.2.1.	The Functions $\operatorname{sn} u$, $\operatorname{cn} u$, and $\operatorname{dn} u$	247
12.2.2.	Basic Results	247
12.3.	Derivatives and Integrals	249
12.3.1.	Derivatives of $\operatorname{sn} u$, $\operatorname{cn} u$, and $\operatorname{dn} u$	249
12.3.2.	Integrals Involving $\operatorname{sn} u$, $\operatorname{cn} u$, and $\operatorname{dn} u$	249
12.4.	Inverse Jacobian Elliptic Functions	250
12.4.1.	Definitions	250
13	Probability Distributions and Integrals, and the Error Function	253
13.1.	Distributions	253
13.1.1.	Definitions	253
13.1.2.	Power Series Representations ($x \geq 0$)	256
13.1.3.	Asymptotic Expansions ($x \gg 0$)	256
13.2.	The Error Function	257
13.2.1.	Definitions	257
13.2.2.	Power Series Representation	257
13.2.3.	Asymptotic Expansion ($x \gg 0$)	257
13.2.4.	Connection Between $P(x)$ and $\operatorname{erf} x$	258
13.2.5.	Integrals Expressible in Terms of $\operatorname{erf} x$	258
13.2.6.	Derivatives of $\operatorname{erf} x$	258
13.2.7.	Integrals of $\operatorname{erfc} x$	258
13.2.8.	Integral and Power Series Representation of $i^n \operatorname{erfc} x$	259
13.2.9.	Value of $i^n \operatorname{erfc} x$ at zero	259
14	Fresnel Integrals, Sine and Cosine Integrals	261
14.1.	Definitions, Series Representations, and Values at Infinity	261
14.1.1.	The Fresnel Integrals	261
14.1.2.	Series Representations	261
14.1.3.	Limiting Values as $x \rightarrow \infty$	263
14.2.	Definitions, Series Representations, and Values at Infinity	263
14.2.1.	Sine and Cosine Integrals	263
14.2.2.	Series Representations	263
14.2.3.	Limiting Values as $x \rightarrow \infty$	264
15	Definite Integrals	265
15.1.	Integrands Involving Powers of x	265
15.2.	Integrands Involving Trigonometric Functions	267
15.3.	Integrands Involving the Exponential Function	270
15.4.	Integrands Involving the Hyperbolic Function	273

15.5.	Integrands Involving the Logarithmic Function	273
15.6.	Integrands Involving the Exponential Integral $Ei(x)$	274
16	Different Forms of Fourier Series	275
16.1.	Fourier Series for $f(x)$ on $-\pi \leq x \leq \pi$	275
16.1.1.	The Fourier Series	275
16.2.	Fourier Series for $f(x)$ on $-L \leq x \leq L$	276
16.2.1.	The Fourier Series	276
16.3.	Fourier Series for $f(x)$ on $a \leq x \leq b$	276
16.3.1.	The Fourier Series	276
16.4.	Half-Range Fourier Cosine Series for $f(x)$ on $0 \leq x \leq \pi$	277
16.4.1.	The Fourier Series	277
16.5.	Half-Range Fourier Cosine Series for $f(x)$ on $0 \leq x \leq L$	277
16.5.1.	The Fourier Series	277
16.6.	Half-Range Fourier Sine Series for $f(x)$ on $0 \leq x \leq \pi$	278
16.6.1.	The Fourier Series	278
16.7.	Half-Range Fourier Sine Series for $f(x)$ on $0 \leq x \leq L$	278
16.7.1.	The Fourier Series	278
16.8.	Complex (Exponential) Fourier Series for $f(x)$ on $-\pi \leq x \leq \pi$	279
16.8.1.	The Fourier Series	279
16.9.	Complex (Exponential) Fourier Series for $f(x)$ on $-L \leq x \leq L$	279
16.9.1.	The Fourier Series	279
16.10.	Representative Examples of Fourier Series	280
16.11.	Fourier Series and Discontinuous Functions	285
16.11.1.	Periodic Extensions and Convergence of Fourier Series	285
16.11.2.	Applications to Closed-Form Summations of Numerical Series	285
17	Bessel Functions	289
17.1.	Bessel's Differential Equation	289
17.1.1.	Different Forms of Bessel's Equation	289
17.2.	Series Expansions for $J_\nu(x)$ and $Y_\nu(x)$	290
17.2.1.	Series Expansions for $J_n(x)$ and $J_\nu(x)$	290
17.2.2.	Series Expansions for $Y_n(x)$ and $Y_\nu(x)$	291
17.2.3.	Expansion of $\sin(x \sin \theta)$ and $\cos(x \sin \theta)$ in Terms of Bessel Functions	292
17.3.	Bessel Functions of Fractional Order	292
17.3.1.	Bessel Functions $J_{\pm(n+1/2)}(x)$	292
17.3.2.	Bessel Functions $Y_{\pm(n+1/2)}(x)$	293
17.4.	Asymptotic Representations for Bessel Functions	294
17.4.1.	Asymptotic Representations for Large Arguments	294
17.4.2.	Asymptotic Representation for Large Orders	294
17.5.	Zeros of Bessel Functions	294
17.5.1.	Zeros of $J_n(x)$ and $Y_n(x)$	294

17.6.	Bessel's Modified Equation	294
17.6.1.	Different Forms of Bessel's Modified Equation	294
17.7.	Series Expansions for $I_\nu(x)$ and $K_\nu(x)$	297
17.7.1.	Series Expansions for $I_n(x)$ and $I_\nu(x)$	297
17.7.2.	Series Expansions for $K_0(x)$ and $K_n(x)$	298
17.8.	Modified Bessel Functions of Fractional Order	298
17.8.1.	Modified Bessel Functions $I_{\pm(n+1/2)}(x)$	298
17.8.2.	Modified Bessel Functions $K_{\pm(n+1/2)}(x)$	299
17.9.	Asymptotic Representations of Modified Bessel Functions	299
17.9.1.	Asymptotic Representations for Large Arguments	299
17.10.	Relationships Between Bessel Functions	299
17.10.1.	Relationships Involving $J_\nu(x)$ and $Y_\nu(x)$	299
17.10.2.	Relationships Involving $I_\nu(x)$ and $K_\nu(x)$	301
17.11.	Integral Representations of $J_n(x)$, $I_n(x)$, and $K_n(x)$	302
17.11.1.	Integral Representations of $J_n(x)$	302
17.12.	Indefinite Integrals of Bessel Functions	302
17.12.1.	Integrals of $J_n(x)$, $I_n(x)$, and $K_n(x)$	302
17.13.	Definite Integrals Involving Bessel Functions	303
17.13.1.	Definite Integrals Involving $J_n(x)$ and Elementary Functions	303
17.14.	Spherical Bessel Functions	304
17.14.1.	The Differential Equation	304
17.14.2.	The Spherical Bessel Function $j_n(x)$ and $y_n(x)$	305
17.14.3.	Recurrence Relations	306
17.14.4.	Series Representations	306
17.14.5.	Limiting Values as $x \rightarrow 0$	306
17.14.6.	Asymptotic Expansions of $j_n(x)$ and $y_n(x)$ When the Order n Is Large	307
17.15.	Fourier-Bessel Expansions	307
18	Orthogonal Polynomials	309
18.1.	Introduction	309
18.1.1.	Definition of a System of Orthogonal Polynomials	309
18.2.	Legendre Polynomials $P_n(x)$	310
18.2.1.	Differential Equation Satisfied by $P_n(x)$	310
18.2.2.	Rodrigues' Formula for $P_n(x)$	310
18.2.3.	Orthogonality Relation for $P_n(x)$	310
18.2.4.	Explicit Expressions for $P_n(x)$	310
18.2.5.	Recurrence Relations Satisfied by $P_n(x)$	312
18.2.6.	Generating Function for $P_n(x)$	313
18.2.7.	Legendre Functions of the Second Kind $Q_n(x)$	313
18.2.8.	Definite Integrals Involving $P_n(x)$	315
18.2.9.	Special Values	315

18.2.10.	Associated Legendre Functions	316
18.2.11.	Spherical Harmonics	318
18.3.	Chebyshev Polynomials $T_n(x)$ and $U_n(x)$	320
18.3.1.	Differential Equation Satisfied by $T_n(x)$ and $U_n(x)$	320
18.3.2.	Rodrigues' Formulas for $T_n(x)$ and $U_n(x)$	320
18.3.3.	Orthogonality Relations for $T_n(x)$ and $U_n(x)$	320
18.3.4.	Explicit Expressions for $T_n(x)$ and $U_n(x)$	321
18.3.5.	Recurrence Relations Satisfied by $T_n(x)$ and $U_n(x)$	325
18.3.6.	Generating Functions for $T_n(x)$ and $U_n(x)$	325
18.4.	Laguerre Polynomials $L_n(x)$	325
18.4.1.	Differential Equation Satisfied by $L_n(x)$	325
18.4.2.	Rodrigues' Formula for $L_n(x)$	325
18.4.3.	Orthogonality Relation for $L_n(x)$	326
18.4.4.	Explicit Expressions for $L_n(x)$ and x^n in Terms of $L_n(x)$	326
18.4.5.	Recurrence Relations Satisfied by $L_n(x)$	327
18.4.6.	Generating Function for $L_n(x)$	327
18.4.7.	Integrals Involving $L_n(x)$	327
18.4.8.	Generalized (Associated) Laguerre Polynomials $L_n^{(\alpha)}(x)$	327
18.5.	Hermite Polynomials $H_n(x)$	329
18.5.1.	Differential Equation Satisfied by $H_n(x)$	329
18.5.2.	Rodrigues' Formula for $H_n(x)$	329
18.5.3.	Orthogonality Relation for $H_n(x)$	330
18.5.4.	Explicit Expressions for $H_n(x)$	330
18.5.5.	Recurrence Relations Satisfied by $H_n(x)$	330
18.5.6.	Generating Function for $H_n(x)$	331
18.5.7.	Series Expansions of $H_n(x)$	331
18.5.8.	Powers of x in Terms of $H_n(x)$	331
18.5.9.	Definite Integrals	331
18.5.10.	Asymptotic Expansion for Large n	332
18.6.	Jacobi Polynomials $P_n^{(\alpha, \beta)}(x)$	332
18.6.1.	Differential Equation Satisfied by $P_n^{(\alpha, \beta)}(x)$	333
18.6.2.	Rodrigues' Formula for $P_n^{(\alpha, \beta)}(x)$	333
18.6.3.	Orthogonality Relation for $P_n^{(\alpha, \beta)}(x)$	333
18.6.4.	A Useful Integral Involving $P_n^{(\alpha, \beta)}(x)$	333
18.6.5.	Explicit Expressions for $P_n^{(\alpha, \beta)}(x)$	333
18.6.6.	Differentiation Formulas for $P_n^{(\alpha, \beta)}(x)$	334
18.6.7.	Recurrence Relation Satisfied by $P_n^{(\alpha, \beta)}(x)$	334
18.6.8.	The Generating Function for $P_n^{(\alpha, \beta)}(x)$	334
18.6.9.	Asymptotic Formula for $P_n^{(\alpha, \beta)}(x)$ for Large n	335
18.6.10.	Graphs of the Jacobi Polynomials $P_n^{(\alpha, \beta)}(x)$	335

19	Laplace Transformation	337
19.1.	Introduction	337
19.1.1.	Definition of the Laplace Transform	337
19.1.2.	Basic Properties of the Laplace Transform	338
19.1.3.	The Dirac Delta Function $\delta(x)$	340
19.1.4.	Laplace Transform Pairs	340
19.1.5.	Solving Initial Value Problems by the Laplace Transform	340
20	Fourier Transforms	353
20.1.	Introduction	353
20.1.1.	Fourier Exponential Transform	353
20.1.2.	Basic Properties of the Fourier Transforms	354
20.1.3.	Fourier Transform Pairs	355
20.1.4.	Fourier Cosine and Sine Transforms	357
20.1.5.	Basic Properties of the Fourier Cosine and Sine Transforms	358
20.1.6.	Fourier Cosine and Sine Transform Pairs	359
21	Numerical Integration	363
21.1.	Classical Methods	363
21.1.1.	Open- and Closed-Type Formulas	363
21.1.2.	Composite Midpoint Rule (open type)	364
21.1.3.	Composite Trapezoidal Rule (closed type)	364
21.1.4.	Composite Simpson's Rule (closed type)	364
21.1.5.	Newton–Cotes formulas	365
21.1.6.	Gaussian Quadrature (open-type)	366
21.1.7.	Romberg Integration (closed-type)	367
22	Solutions of Standard Ordinary Differential Equations	371
22.1.	Introduction	371
22.1.1.	Basic Definitions	371
22.1.2.	Linear Dependence and Independence	371
22.2.	Separation of Variables	373
22.3.	Linear First-Order Equations	373
22.4.	Bernoulli's Equation	374
22.5.	Exact Equations	375
22.6.	Homogeneous Equations	376
22.7.	Linear Differential Equations	376
22.8.	Constant Coefficient Linear Differential Equations—Homogeneous Case	377
22.9.	Linear Homogeneous Second-Order Equation	381

22.10.	Linear Differential Equations—Inhomogeneous Case and the Green's Function	382
22.11.	Linear Inhomogeneous Second-Order Equation	389
22.12.	Determination of Particular Integrals by the Method of Undetermined Coefficients	390
22.13.	The Cauchy–Euler Equation	393
22.14.	Legendre's Equation	394
22.15.	Bessel's Equations	394
22.16.	Power Series and Frobenius Methods	396
22.17.	The Hypergeometric Equation	403
22.18.	Numerical Methods	404
23	Vector Analysis	415
23.1.	Scalars and Vectors	415
23.1.1.	Basic Definitions	415
23.1.2.	Vector Addition and Subtraction	417
23.1.3.	Scaling Vectors	418
23.1.4.	Vectors in Component Form	419
23.2.	Scalar Products	420
23.3.	Vector Products	421
23.4.	Triple Products	422
23.5.	Products of Four Vectors	423
23.6.	Derivatives of Vector Functions of a Scalar t	423
23.7.	Derivatives of Vector Functions of Several Scalar Variables	425
23.8.	Integrals of Vector Functions of a Scalar Variable t	426
23.9.	Line Integrals	427
23.10.	Vector Integral Theorems	428
23.11.	A Vector Rate of Change Theorem	431
23.12.	Useful Vector Identities and Results	431
24	Systems of Orthogonal Coordinates	433
24.1.	Curvilinear Coordinates	433
24.1.1.	Basic Definitions	433
24.2.	Vector Operators in Orthogonal Coordinates	435
24.3.	Systems of Orthogonal Coordinates	436
25	Partial Differential Equations and Special Functions	447
25.1.	Fundamental Ideas	447
25.1.1.	Classification of Equations	447
25.2.	Method of Separation of Variables	451
25.2.1.	Application to a Hyperbolic Problem	451
25.3.	The Sturm–Liouville Problem and Special Functions	456
25.4.	A First-Order System and the Wave Equation	456

25.5.	Conservation Equations (Laws)	457
25.6.	The Method of Characteristics	458
25.7.	Discontinuous Solutions (Shocks)	462
25.8.	Similarity Solutions	465
25.9.	Burgers's Equation, the KdV Equation, and the KdVB Equation	467
25.10.	The Poisson Integral Formulas	470
25.11.	The Riemann Method	471
26	Qualitative Properties of the Heat and Laplace Equation	473
26.1.	The Weak Maximum/Minimum Principle for the Heat Equation	473
26.2.	The Maximum/Minimum Principle for the Laplace Equation	473
26.3.	Gauss Mean Value Theorem for Harmonic Functions in the Plane	473
26.4.	Gauss Mean Value Theorem for Harmonic Functions in Space	474
27	Solutions of Elliptic, Parabolic, and Hyperbolic Equations	475
27.1.	Elliptic Equations (The Laplace Equation)	475
27.2.	Parabolic Equations (The Heat or Diffusion Equation)	482
27.3.	Hyperbolic Equations (Wave Equation)	488
28	The z-Transform	493
28.1.	The z -Transform and Transform Pairs	493
29	Numerical Approximation	499
29.1.	Introduction	499
29.1.1.	Linear Interpolation	499
29.1.2.	Lagrange Polynomial Interpolation	500
29.1.3.	Spline Interpolation	500
29.2.	Economization of Series	501
29.3.	Padé Approximation	503
29.4.	Finite Difference Approximations to Ordinary and Partial Derivatives	505
30	Conformal Mapping and Boundary Value Problems	509
30.1.	Analytic Functions and the Cauchy-Riemann Equations	509
30.2.	Harmonic Conjugates and the Laplace Equation	510
30.3.	Conformal Transformations and Orthogonal Trajectories	510
30.4.	Boundary Value Problems	511
30.5.	Some Useful Conformal Mappings	512
	Short Classified Reference List	525
	Index	529

Preface

This book contains a collection of general mathematical results, formulas, and integrals that occur throughout applications of mathematics. Many of the entries are based on the updated fifth edition of Gradshteyn and Ryzhik's "Tables of Integrals, Series, and Products," though during the preparation of the book, results were also taken from various other reference works. The material has been arranged in a straightforward manner, and for the convenience of the user a quick reference list of the simplest and most frequently used results is to be found in Chapter 0 at the front of the book. Tab marks have been added to pages to identify the twelve main subject areas into which the entries have been divided and also to indicate the main interconnections that exist between them. Keys to the tab marks are to be found inside the front and back covers.

The Table of Contents at the front of the book is sufficiently detailed to enable rapid location of the section in which a specific entry is to be found, and this information is supplemented by a detailed index at the end of the book. In the chapters listing integrals, instead of displaying them in their canonical form, as is customary in reference works, in order to make the tables more convenient to use, the integrands are presented in the more general form in which they are likely to arise. It is hoped that this will save the user the necessity of reducing a result to a canonical form before consulting the tables. Wherever it might be helpful, material has been added explaining the idea underlying a section or describing simple techniques that are often useful in the application of its results.

Standard notations have been used for functions, and a list of these together with their names and a reference to the section in which they occur or are defined is to be found at the front of the book. As is customary with tables of indefinite integrals, the additive arbitrary constant of integration has always been omitted. The result of an integration may take more than one form, often depending on the method used for its evaluation, so only the most common forms are listed.

A user requiring more extensive tables, or results involving the less familiar special functions, is referred to the short classified reference list at the end of the book. The list contains works the author found to be most useful and which a user is likely to find readily accessible in a library, but it is in no sense a comprehensive bibliography. Further specialist references are to be found in the bibliographies contained in these reference works.

Every effort has been made to ensure the accuracy of these tables and, whenever possible, results have been checked by means of computer symbolic algebra and integration programs, but the final responsibility for errors must rest with the author.

Preface to the Fourth Edition

The preparation of the fourth edition of this handbook provided the opportunity to enlarge the sections on special functions and orthogonal polynomials, as suggested by many users of the third edition. A number of substantial additions have also been made elsewhere, like the enhancement of the description of spherical harmonics, but a major change is the inclusion of a completely new chapter on conformal mapping. Some minor changes that have been made are correcting of a few typographical errors and rearranging the last four chapters of the third edition into a more convenient form. A significant development that occurred during the later stages of preparation of this fourth edition was that my friend and colleague Dr. Hui-Hui Dai joined me as a co-editor.

Chapter 30 on conformal mapping has been included because of its relevance to the solution of the Laplace equation in the plane. To demonstrate the connection with the Laplace equation, the chapter is preceded by a brief introduction that demonstrates the relevance of conformal mapping to the solution of boundary value problems for real harmonic functions in the plane. Chapter 30 contains an extensive atlas of useful mappings that display, in the usual diagrammatic way, how given analytic functions $w = f(z)$ map regions of interest in the complex z -plane onto corresponding regions in the complex w -plane, and conversely. By forming composite mappings, the basic atlas of mappings can be extended to more complicated regions than those that have been listed. The development of a typical composite mapping is illustrated by using mappings from the atlas to construct a mapping with the property that a region of complicated shape in the z -plane is mapped onto the much simpler region comprising the upper half of the w -plane. By combining this result with the Poisson integral formula, described in another section of the handbook, a boundary value problem for the original, more complicated region can be solved in terms of a corresponding boundary value problem in the simpler region comprising the upper half of the w -plane.

The chapter on ordinary differential equations has been enhanced by the inclusion of material describing the construction and use of the Green's function when solving initial and boundary value problems for linear second order ordinary differential equations. More has been added about the properties of the Laplace transform and the Laplace and Fourier convolution theorems, and the list of Laplace transform pairs has been enlarged. Furthermore, because of their use with special techniques in numerical analysis when solving differential equations, a new section has been included describing the Jacobi orthogonal polynomials. The section on the Poisson integral formulas has also been enlarged, and its use is illustrated by an example. A brief description of the Riemann method for the solution of hyperbolic equations has been included because of the important theoretical role it plays when examining general properties of wave-type equations, such as their domains of dependence.

For the convenience of users, a new feature of the handbook is a CD-ROM that contains the classified lists of integrals found in the book. These lists can be searched manually, and when results of interest have been located, they can be either printed out or used in papers or

worksheets as required. This electronic material is introduced by a set of notes (also included in the following pages) intended to help users of the handbook by drawing attention to different notations and conventions that are in current use. If these are not properly understood, they can cause confusion when results from some other sources are combined with results from this handbook. Typically, confusion can occur when dealing with Laplace's equation and other second order linear partial differential equations using spherical polar coordinates because of the occurrence of differing notations for the angles involved and also when working with Fourier transforms for which definitions and normalizations differ. Some explanatory notes and examples have also been provided to interpret the meaning and use of the inversion integrals for Laplace and Fourier transforms.

Alan Jeffrey

alan.jeffrey@newcastle.ac.uk

Hui-Hui Dai

mahhdai@math.cityu.edu.hk

Notes for Handbook Users

The material contained in the fourth edition of the *Handbook of Mathematical Formulas and Integrals* was selected because it covers the main areas of mathematics that find frequent use in applied mathematics, physics, engineering, and other subjects that use mathematics. The material contained in the handbook includes, among other topics, algebra, calculus, indefinite and definite integrals, differential equations, integral transforms, and special functions.

For the convenience of the user, the most frequently consulted chapters of the book are to be found on the accompanying CD that allows individual results of interest to be printed out, included in a work sheet, or in a manuscript.

A major part of the handbook concerns integrals, so it is appropriate that mention of these should be made first. As is customary, when listing indefinite integrals, the arbitrary additive constant of integration has always been omitted. The results concerning integrals that are available in the mathematical literature are so numerous that a strict selection process had to be adopted when compiling this work. The criterion used amounted to choosing those results that experience suggested were likely to be the most useful in everyday applications of mathematics. To economize on space, when a simple transformation can convert an integral containing several parameters into one or more integrals with fewer parameters, only these simpler integrals have been listed.

For example, instead of listing indefinite integrals like $\int e^{ax} \sin(bx + c) dx$ and $\int e^{ax} \cos(bx + c) dx$, each containing the three parameters a , b , and c , the simpler indefinite integrals $\int e^{ax} \sin bx dx$ and $\int e^{ax} \cos bx dx$ contained in entries **5.1.3.1(1)** and **5.1.3.1(4)** have been listed. The results containing the parameter c then follow after using additive property of integrals with these tabulated entries, together with the trigonometric identities $\sin(bx + c) = \sin bx \cos c + \cos bx \sin c$ and $\cos(bx + c) = \cos bx \cos c - \sin bx \sin c$.

The order in which integrals are listed can be seen from the various section headings. If a required integral is not found in the appropriate section, it is possible that it can be transformed into an entry contained in the book by using one of the following elementary methods:

1. Representing the integrand in terms of partial fractions.
2. Completing the square in denominators containing quadratic factors.
3. Integration using a substitution.
4. Integration by parts.
5. Integration using a recurrence relation (recursion formula),

or by a combination of these. It must, however, always be remembered that not all integrals can be evaluated in terms of elementary functions. Consequently, many simple looking integrals cannot be evaluated analytically, as is the case with

$$\int \frac{\sin x}{a + be^x} dx.$$

A Comment on the Use of Substitutions

When using substitutions, it is important to ensure the substitution is both continuous and one-to-one, and to remember to incorporate the substitution into the dx term in the integrand. When a definite integral is involved the substitution must also be incorporated into the limits of the integral.

When an integrand involves an expression of the form $\sqrt{a^2 - x^2}$, it is usual to use the substitution $x = |a \sin \theta|$ which is equivalent to $\theta = \arcsin(x/|a|)$, though the substitution $x = |a| \cos \theta$ would serve equally well. The occurrence of an expression of the form $\sqrt{a^2 + x^2}$ in an integrand can be treated by making the substitution $x = |a| \tan \theta$, when $\theta = \arctan(x/|a|)$ (see also Section 9.1.1). If an expression of the form $\sqrt{x^2 - a^2}$ occurs in an integrand, the substitution $x = |a| \sec \theta$ can be used. Notice that whenever the square root occurs the *positive* square root is always implied, to ensure that the function is single valued.

If a substitution involving either $\sin \theta$ or $\cos \theta$ is used, it is necessary to restrict θ to a suitable interval to ensure the substitution remains one-to-one. For example, by restricting θ to the interval $-\frac{1}{2}\pi \leq \theta \leq \frac{1}{2}\pi$, the function $\sin \theta$ becomes one-to-one, whereas by restricting θ to the interval $0 \leq \theta \leq \pi$, the function $\cos \theta$ becomes one-to-one. Similarly, when the inverse trigonometric function $y = \arcsin x$ is involved, equivalent to $x = \sin y$, the function becomes one-to-one in its principal branch $-\frac{1}{2}\pi \leq y \leq \frac{1}{2}\pi$, so $\arcsin(\sin x) = x$ for $-\frac{1}{2}\pi \leq x \leq \frac{1}{2}\pi$ and $\sin(\arcsin x) = x$ for $-1 \leq x \leq 1$. Correspondingly, the inverse trigonometric function $y = \arccos x$, equivalently $x = \cos y$, becomes one-to-one in its principal branch $0 \leq y \leq \pi$, so $\arccos(\cos x) = x$ for $0 \leq x \leq \pi$ and $\cos(\arccos x) = x$ for $-1 \leq x \leq 1$.

It is important to recognize that a given integral may have more than one representation, because the form of the result is often determined by the method used to evaluate the integral. Some representations are more convenient to use than others so, where appropriate, integrals of this type are listed using their simplest representation. A typical example of this type is

$$\int \frac{dx}{\sqrt{a^2 + x^2}} = \begin{cases} \operatorname{arcsinh}(x/a) \\ \ln(x + \sqrt{a^2 + x^2}) \end{cases}$$

where the result involving the logarithmic function is usually the more convenient of the two forms. In this handbook, both the inverse trigonometric and inverse hyperbolic functions all carry the prefix “arc.” So, for example, the inverse sine function is written $\arcsin x$ and the inverse hyperbolic sine function is written $\operatorname{arcsinh} x$, with corresponding notational conventions for the other inverse trigonometric and hyperbolic functions. However, many other works denote the inverse of these functions by adding the superscript $^{-1}$ to the name of the function, in which case $\arcsin x$ becomes $\sin^{-1} x$ and $\operatorname{arcsinh} x$ becomes $\sinh^{-1} x$. Elsewhere yet another notation is in use where, instead of using the prefix “arc” to denote an inverse hyperbolic

function, the prefix “arg” is used, so that $\operatorname{arcsinh} x$ becomes $\operatorname{argsinh} x$, with the corresponding use of the prefix “arg” to denote the other inverse hyperbolic functions. This notation is preferred by some authors because they consider that the prefix “arc” implies an angle is involved, whereas this is not the case with hyperbolic functions. So, instead, they use the prefix “arg” when working with inverse hyperbolic functions.

Example: Find $I = \int \frac{x^5}{\sqrt{a^2-x^2}} dx$.

Of the two obvious substitutions $x = |a| \sin \theta$ and $x = |a| \cos \theta$ that can be used, we will make use of the first one, while remembering to restrict θ to the interval $-\frac{1}{2}\pi \leq \theta \leq \frac{1}{2}\pi$ to ensure the transformation is one-to-one. We have $dx = |a| \cos \theta d\theta$, while $\sqrt{a^2-x^2} = \sqrt{a^2-a^2 \sin^2 \theta} = |a| \sqrt{1-\sin^2 \theta} = |a| \cos \theta$. However $\cos \theta$ is positive in the interval $-\frac{1}{2}\pi \leq \theta \leq \frac{1}{2}\pi$, so we may set $\sqrt{a^2-x^2} = |a| \cos \theta$. Substituting these results into the integrand of I gives

$$I = \int \frac{|a|^5 \sin^5 \theta |a| \cos \theta d\theta}{|a| \cos \theta} = a^4 |a| \int \sin^5 \theta d\theta,$$

and this trigonometric integral can be found using entry **9.2.2.2**, 5. This result can be expressed in terms of x by using the fact that $\theta = \arcsin(x/|a|)$, so that after some manipulation we find that

$$I = -\frac{1}{5}x^4 \sqrt{a^2-x^2} - \frac{4a^2}{15} \sqrt{a^2-x^2} (2a^2+x^2).$$

A Comment on Integration by Parts

Integration by parts can often be used to express an integral in a simpler form, but it also has another important property because it also leads to the derivation of a **reduction formula**, also called a **recursion relation**. A reduction formula expresses an integral involving one or more parameters in terms of a simpler integral of the same form, but with the parameters having smaller values. Let us consider two examples in some detail, the second of which given a brief mention in Section **1.15.3**.

Example:

- (a) Find a reduction formula for

$$I_m = \int \cos^m \theta d\theta,$$

and hence find an expression for I_5 .

- (b) Modify the result to find a recurrence relation for

$$J_m = \int_0^{\pi/2} \cos^m \theta d\theta,$$

and use it to find expressions for J_m when m is even and when it is odd.

To derive the result for (a), write

$$\begin{aligned}
 I_m &= \int \cos^{m-1} \theta \frac{d(\sin \theta)}{d\theta} d\theta \\
 &= \cos^{m-1} \theta \sin \theta - \int \sin \theta (m-1) \cos^{m-2} \theta (-\sin \theta) d\theta \\
 &= \cos^{m-1} \theta \sin \theta + (m-1) \int \cos^{m-2} \theta (1 - \cos^2 \theta) d\theta \\
 &= \cos^{m-1} \theta \sin \theta + (m-1) \int \cos^{m-2} \theta d\theta - (m-1) \int \cos^m \theta d\theta.
 \end{aligned}$$

Combining terms and using the form of I_m , this gives the reduction formula

$$I_m = \frac{\cos^{m-1} \theta \sin \theta}{m} + \left(\frac{m-1}{m} \right) I_{m-2}.$$

we have $I_1 = \int \cos \theta d\theta = \sin \theta$. So using the expression for I_1 , setting $m = 5$ and using the recurrence relation to step up in intervals of 2, we find that

$$I_3 = \frac{1}{3} \cos^2 \theta \sin \theta + \frac{2}{3} I_1 = \frac{1}{3} \cos^2 \theta + \frac{2}{3} \sin \theta,$$

and hence that

$$\begin{aligned}
 I_5 &= \frac{1}{5} \cos^4 \theta \sin \theta + \frac{4}{5} I_3 \\
 &= \frac{1}{5} \cos^4 \theta \sin \theta - \frac{4}{15} \sin^3 \theta + \frac{4}{5} \sin \theta.
 \end{aligned}$$

The derivation of a result for (b) uses the same reasoning as in (a), apart from the fact that the limits must be applied to both the integral, and also to the uv term in $\int u dv = uv - \int v du$, so the result becomes $\int_a^b u dv = (uv)_a^b - \int_a^b v du$. When this is done it leads to the result

$$J_m = \left(\frac{\cos^{m-1} \theta \sin \theta}{m} \right)_{\theta=0}^{\pi/2} + \left(\frac{m-1}{m} \right) J_{m-2} = \left(\frac{m-1}{m} \right) J_{m-2}.$$

When m is even, this recurrence relation links J_m to $J_0 = \int_0^{\pi/2} 1 d\theta = \frac{1}{2}\pi$, and when m is odd, it links J_m to $J_1 = \int_0^{\pi/2} \cos \theta d\theta = 1$. Using these results sequentially in the recurrence relation, we find that

$$J_{2n} = \frac{1 \cdot 3 \cdot 5 \dots (2n-1)}{2 \cdot 4 \cdot 6 \dots 2n} \frac{1}{2} \pi, \quad (m = 2n \text{ is even})$$

and

$$J_{2n+1} = \frac{2 \cdot 4 \cdot 6 \dots 2n}{3 \cdot 5 \cdot 7 \dots (2n+1)} \quad (m = 2n+1 \text{ is odd}).$$

Example: The following is an example of a recurrence formula that contains two parameters. If $I_{m,n} = \int \sin^m \theta \cos^n \theta d\theta$, an argument along the lines of the one used in the previous example, but writing

$$I_{m,n} = \int \sin^{m-1} \theta \cos^n \theta d(-\cos \theta),$$

leads to the result

$$(m+n)I_{m,n} = -\sin^{m-1} \theta \cos^{n+1} \theta + (m-1)I_{m-2,n},$$

in which n remains unchanged, but m decreases by 2.

Had integration by parts been used differently with $I_{m,n}$ written as

$$I_{m,n} = \int \sin^m \theta \cos^{n-1} \theta d(\sin \theta)$$

a different reduction formula would have been obtained in which m remains unchanged but n decreases by 2.

Some Comments on Definite Integrals

Definite integrals evaluated over the semi-infinite interval $[0, \infty)$ or over the infinite interval $(-\infty, \infty)$ are improper integrals and when they are convergent they can often be evaluated by means of contour integration. However, when considering these improper integrals, it is desirable to know in advance if they are convergent, or if they only have a finite value in the sense of a Cauchy principal value. (see Section 1.15.4). A geometrical interpretation of a Cauchy principal value for an integral of a function $f(x)$ over the interval $(-\infty, \infty)$ follows by regarding an area between the curve $y = f(x)$ and the x -axis as positive if it lies above the x -axis and negative if it lies below it. Then, when finding a Cauchy principal value, the areas to the left and right of the y -axis are paired off symmetrically as the limits of integration approach $\pm\infty$. If the result is a finite number, this is the Cauchy principal value to be attributed to the definite integral $\int_{-\infty}^{\infty} f(x)dx$, otherwise the integral is divergent. When an improper integral is convergent, its value and its Cauchy principal value coincide.

There are various tests for the convergence of improper integrals, but the ones due to Abel and Dirichlet given in Section 1.15.4 are the main ones. Convergent integrals exist that do not satisfy all of the conditions of the theorems, showing that although these tests represent *sufficient* conditions for convergence, they are *not necessary* ones.

Example: Let us establish the convergence of the improper integral $\int_a^\infty \frac{\sin mx}{x^p} dx$, given that $a, p > 0$.

To use the Dirichlet test we set $f(x) = \sin x$ and $g(x) = 1/x^p$. Then $\lim_{x \rightarrow \infty} g(x) = 0$ and $\int_a^\infty |g'(x)|dx = 1/a^p$ is finite, so this integral involving $g(x)$ converges. We also have $F(b) = \int_a^b \sin mx dx = (\cos ma - \cos mb)/m$, from which it follows that $|F(b)| \leq 2$ for all

$a \leq x \leq b < \infty$. Thus the conditions of the Dirichlet test are satisfied showing that $\int_a^\infty \frac{\sin x}{x^p} dx$ is convergent for $a, p > 0$.

It is necessary to exercise caution when using the fundamental theorem of calculus to evaluate an improper integral in case the integrand has a singularity (becomes infinite) inside the interval of integration. If this occurs the use of the fundamental theorem of calculus is invalid.

Example: The improper integral $\int_{-a}^a \frac{dx}{x^2}$ with $a > 0$ has a singularity at the origin and is, in fact, divergent. This follows because if $\varepsilon, \delta > 0$, we have $\lim_{\varepsilon \rightarrow 0} \int_{-a}^{-\varepsilon} \frac{dx}{x^2} + \lim_{\delta \rightarrow 0} \int_{\delta}^a \frac{dx}{x^2} = \infty$. However, an incorrect application of the fundamental theorem of calculus gives $\int_{-a}^a \frac{dx}{x^2} = \left(-\frac{1}{x}\right)_{x=-a}^a = -\frac{2}{a}$. Although this result is finite, it is obviously incorrect because the integrand is positive over the interval of integration, so the definite integral must also be positive, but this is not the case here because $a > 0$ so $-2/a < 0$.

Two simple results that often save time concern the integration of even and odd functions $f(x)$ over an interval $-a \leq x \leq a$ that is symmetrical about the origin.

We have the obvious result that when $f(x)$ is *odd*, that is when $f(-x) = -f(x)$, then

$$\int_{-a}^a f(x) dx = 0,$$

and when $f(x)$ is *even*, that is when $f(-x) = f(x)$, then

$$\int_{-a}^a f(x) dx = 2 \int_0^a f(x) dx.$$

These simple results have many uses as, for example, when working with Fourier series and elsewhere.

Some Comments on Notations, the Choice of Symbols, and Normalization

Unfortunately there is no universal agreement on the choice of symbols used to identify a point P in cylindrical and spherical polar coordinates. Nor is there universal agreement on the choice of symbols used to represent some special functions, or on the normalization of Fourier transforms. Accordingly, before using results derived from other sources with those given in this handbook, it is necessary to check the notations, symbols, and normalization used elsewhere prior to combining the results.

Symbols Used with Curvilinear Coordinates

To avoid confusion, the symbols used in this handbook relating to plane polar coordinates, cylindrical polar coordinates, and spherical polar coordinates are shown in the diagrams in Section 24.3.

The **plane polar coordinates** (r, θ) that identify a point P in the (x, y) -plane are shown in Figure 1(a). The angle θ is the **azimuthal angle** measured counterclockwise from the x -axis in the (x, y) -plane to the radius vector r drawn from the origin to the point P . The connection between the Cartesian and the plane polar coordinates of P is given by $x = r \cos \theta$, $y = r \sin \theta$, with $0 \leq \theta < 2\pi$.

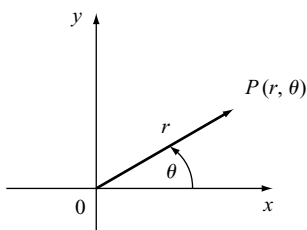

Figure 1(a)

We mention here that a different convention denotes the **azimuthal angle** in plane polar coordinates by ϕ .

The **cylindrical polar coordinates** (r, θ, z) that identify a point P in space are shown in Figure 1(b). The angle θ is again the **azimuthal angle** measured as in plane polar coordinates, r is the radial distance measured from the origin in the (x, y) -plane to the projection of P onto the (x, y) -plane, and z is the perpendicular distance of P above the (x, y) -plane. The connection between cartesian and cylindrical polar coordinates used in this handbook is given by $x = r \cos \theta$, $y = r \sin \theta$ and $z = z$, with $0 \leq \theta < 2\pi$.

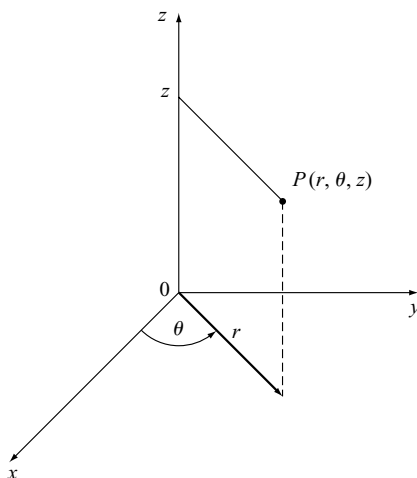

Figure 1(b)

Here also, in a different convention involving cylindrical polar coordinates, the azimuthal angle is denoted by ϕ instead of by θ .

The spherical polar coordinates (r, θ, ϕ) that identify a point P in space are shown in Figure 1(c). Here, differently from plane cylindrical coordinates, the **azimuthal angle** measured as in plane cylindrical coordinates is denoted by ϕ , the radius r is measured from the origin to point P , and the **polar angle** measured from the z -axis to the radius vector OP is denoted by θ , with $0 \leq \phi < 2\pi$, and $0 \leq \theta \leq \pi$. The cartesian and spherical polar coordinates used in this handbook are connected by $x = r \sin \theta \cos \phi$, $y = r \sin \theta \sin \phi$, $z = r \cos \theta$.

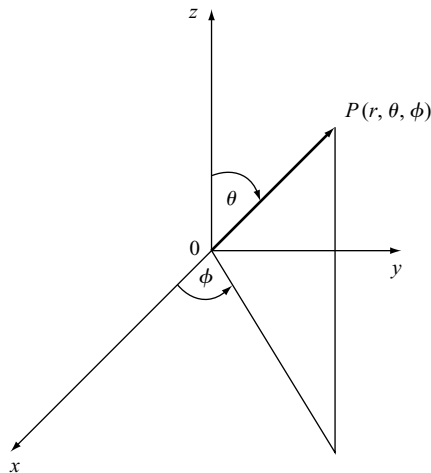

Figure 1(c)

In a different convention the roles of θ and ϕ are interchanged, so the azimuthal angle is denoted by θ , and the polar angle is denoted by ϕ .

Bessel Functions

There is general agreement that the **Bessel function of the first kind of order ν** is denoted by $J_\nu(x)$, though sometimes the symbol ν is reserved for orders that are not integral, in which case n is used to denote integral orders. However, notations differ about the representation of the **Bessel function of the second kind of order ν** . In this handbook, a definition of the Bessel function of the second kind is adopted that is true for *all* orders ν (both integral and fractional) and it is denoted by $Y_\nu(x)$. However, a widely used alternative notation for this same Bessel function of the second kind of order ν uses the notation $N_\nu(x)$. This choice of notation, sometimes called the **Neumann form of the Bessel function of the second kind of order ν** , is used in recognition of the fact that it was defined and introduced by the German mathematician Carl Neumann. His definition, but with $Y_\nu(x)$ in place of $N_\nu(x)$, is given in Section 17.2.2. The reason for the rather strange form of this definition is because when the second linearly independent solution of Bessel's equation is derived using the Frobenius

method, the nature of the solution takes one form when ν is an integer and a different one when ν is not an integer. The form of definition of $Y_\nu(x)$ used here overcomes this difficulty because it is valid for all ν .

The recurrence relations for all Bessel functions can be written as

$$\begin{aligned} Z_{\nu-1}(x) + Z_{\nu+1}(x) &= \frac{2\nu}{x} Z_\nu(x), \\ Z_{\nu-1}(x) - Z_{\nu+1}(x) &= 2Z'_\nu(x), \\ Z'_\nu(x) &= Z_{\nu-1}(x) - \frac{\nu}{x} Z_\nu(x)' \\ Z'_\nu(x) &= -Z_{\nu+1}(x) + \frac{\nu}{x} Z_\nu(x), \end{aligned} \tag{1}$$

where $Z_\nu(x)$ can be either $J_\nu(x)$ or $Y_\nu(x)$. Thus any recurrence relation derived from these results will apply to all Bessel functions. Similar general results exist for the modified Bessel functions $I_\nu(x)$ and $K_\nu(x)$.

Normalization of Fourier Transforms

The convention adopted in this handbook is to define the **Fourier transform** of a function $f(x)$ as the function $F(\omega)$ where

$$F(\omega) = \frac{1}{\sqrt{2\pi}} \int_{-\infty}^{\infty} f(x) e^{i\omega x} dx, \tag{2}$$

when the **inverse Fourier transform** becomes

$$f(x) = \frac{1}{\sqrt{2\pi}} \int_{-\infty}^{\infty} F(\omega) e^{-i\omega x} d\omega, \tag{3}$$

where the normalization factor multiplying each integral in this Fourier transform pair is $1/\sqrt{2\pi}$. However other conventions for the normalization are in common use, and they follow from the requirement that the product of the two normalization factors in the Fourier and inverse Fourier transforms must equal $1/(2\pi)$.

Thus another convention that is used defines the Fourier transform of $f(x)$ as

$$F(\omega) = \int_{-\infty}^{\infty} f(x) e^{i\omega x} dx \tag{4}$$

and the inverse Fourier transform as

$$f(x) = \frac{1}{2\pi} \int_{-\infty}^{\infty} F(\omega) e^{-i\omega x} d\omega. \tag{5}$$

To complicate matters still further, in some conventions the factor $e^{i\omega x}$ in the integral defining $F(\omega)$ is replaced by $e^{-i\omega x}$ and to compensate the factor $e^{-i\omega x}$ in the integral defining $f(x)$ is replaced by $e^{i\omega x}$.

If a Fourier transform is defined in terms of an angular frequency, the ambiguity concerning the choice of normalization factors disappears because the Fourier transform of $f(x)$ becomes

$$F(\omega) = \int_{-\infty}^{\infty} f(x)e^{2\pi i x s} dx \quad (6)$$

and the inverse Fourier transform becomes

$$f(x) = \int_{-\infty}^{\infty} F(\omega)e^{-2\pi i x \omega} d\omega. \quad (7)$$

Nevertheless, the difference between definitions still continues because sometimes the exponential factor in $F(s)$ is replaced by $e^{-2\pi i x s}$, in which case the corresponding factor in the inverse Fourier transform becomes $e^{2\pi i x s}$. These remarks should suffice to convince a reader of the necessity to check the convention used before combining a Fourier transform pair from another source with results from this handbook.

Some Remarks Concerning Elementary Ways of Finding Inverse Laplace Transforms

The Laplace transform $F(s)$ of a suitably integrable function $f(x)$ is defined by the improper integral

$$F(s) = \int_0^{\infty} f(x)e^{-xs} dx. \quad (8)$$

Let a Laplace transform $F(s)$ be the quotient $F(s) = P(s)/Q(s)$ of two polynomials $P(s)$ and $Q(s)$. Finding the inverse transform $\mathcal{L}^{-1}\{F(s)\} = f(x)$ can be accomplished by simplifying $F(s)$ using partial fractions, and then using the Laplace transform pairs in Table 19.1 together with the operational properties of the transform given in **19.1.2.1**. Notice that the degree of $P(s)$ must be less than the degree of $Q(s)$ because from the limiting condition in **19.11.2.1(10)**, if $F(s)$ is to be a Laplace transform of some function $f(x)$, it is necessary that $\lim_{s \rightarrow \infty} F(s) = 0$.

The same approach is valid if exponential terms of the type e^{-as} occur in the numerator $P(s)$ because depending on the form of the partial fraction representation of $F(s)$, such terms will simply introduce either a Heaviside step function $H(x - a)$, or a Dirac delta function $\delta(x - a)$ into the resulting expression for $f(x)$.

On occasions, if a Laplace transform can be expressed as the product of two simpler Laplace transforms, the convolution theorem can be used to simplify the task of inverting the Laplace transform. However, when factoring the transform before using the convolution theorem, care must be taken to ensure that each factor is in fact a Laplace transform of a function of x . This is easily accomplished by appeal to the limiting condition in **19.11.2.1(10)**, because if $F(s)$ is factored as $F(s) = F_1(s)F_2(s)$, the functions $F_1(s)$ and $F_2(s)$ will only be the Laplace transforms of some functions $f_1(x)$ and $f_2(x)$ if $\lim_{s \rightarrow \infty} F_1(s) = 0$ and $\lim_{s \rightarrow \infty} F_2(s) = 0$.

Example: (a) Find $\mathcal{L}^{-1}\{F(s)\}$ if $F(s) = \frac{s^3+3s^2+5s+15}{(s^2+1)(s^2+4s+13)}$. (b) Find $\mathcal{L}^{-1}\{F(s)\}$ if $F(s) = \frac{s^2}{(s^2+a^2)^2}$.

To solve (a) using partial fractions we write $F(s)$ as $F(s) = \frac{1}{s^2+1} + \frac{s+2}{s^2+4s+13}$. Taking the inverse Laplace transform of $F(s)$ and using entry 26 in Table 19.1 gives

$$\mathcal{L}^{-1}\{F(s)\} = \sin x + \mathcal{L}^{-1}\left(\frac{s+2}{s^2+4s+13}\right).$$

Completing the square in the denominator of the second term and writing, $\frac{s+2}{s^2+4s+13} = \frac{s+2}{(s+2)^2+3^2}$, we see from the first shift theorem in **19.1.2.1(4)** and entry 27 in Table 19.1 that $\mathcal{L}^{-1}\left\{\frac{s+2}{(s+2)^2+3^2}\right\} = e^{-2x} \cos 3x$. Finally, combining results, we have

$$\mathcal{L}^{-1}\{F(s)\} = \sin x + e^{-2x} \cos 3x.$$

To solve (b) by the convolution transform, $F(s)$ must be expressed as the product of two factors. The transform $F(s)$ can be factored in two obvious ways, the first being $F(s) = \frac{s^2}{(s^2+a^2)} \frac{1}{(s^2+a^2)}$ and the second being $F(s) = \frac{s}{(s^2+a^2)} \frac{s}{(s^2+a^2)}$.

Of these two expressions, only the second is the product of two Laplace transforms, namely the product of the Laplace transforms of $\cos ax$. The first result cannot be used because the factor $s^2/(s^2+a^2)$ fails the limiting condition in **19.11.2.1(10)**, and so is not the Laplace transform of a function of x .

The inverse of the convolution theorem asserts that if $F(s)$ and $G(s)$ are Laplace transforms of the functions $f(x)$ and $g(x)$, then

$$\mathcal{L}^{-1}\{F(s)G(s)\} = \int_0^x f(\tau)g(x-\tau)d\tau. \quad (9)$$

So setting $F(s) = G(s) = \cos ax$, it follows that

$$f(x) = \mathcal{L}^{-1}\left\{\frac{s^2}{(s^2+a^2)^2}\right\} = \int_0^x \cos \tau \cos(x-\tau)d\tau = \frac{\sin ax}{2a} + \frac{x \cos ax}{2}.$$

When more complicated Laplace transforms occur, it is necessary to find the inverse Laplace transform by using contour integration to evaluate the inversion integral in **19.1.1.1(5)**. More will be said about this, and about the use of the Fourier inversion integral, after a brief review of some key results from complex analysis.

Using the Fourier and Laplace Inversion Integrals

As a preliminary to discussing the Fourier and Laplace inversion integrals, it is necessary to record some key results from complex analysis that will be used.

An analytic function A complex valued function $f(z)$ of the complex variable $z = x + iy$ is said to be **analytic** on an open domain G (an area in the z -plane without its boundary points) if it has a derivative at each point of G . Other names used in place of analytic are *holomorphic* and *regular*. A function $f(z) = u(x, y) + v(x, y)$ will be analytic in a domain G if at every point of G it satisfies the **Cauchy-Riemann equations**

$$\frac{\partial u}{\partial x} = \frac{\partial v}{\partial y} \quad \text{and} \quad \frac{\partial u}{\partial y} = -\frac{\partial v}{\partial x}. \quad (10)$$

These conditions are sufficient to ensure that $f(z)$ had a derivative at every point of G , in which case

$$\frac{df}{dz} = \frac{\partial u}{\partial x} + i \frac{\partial v}{\partial x} = \frac{\partial v}{\partial y} - i \frac{\partial u}{\partial y}. \quad (11)$$

A pole of $f(z)$ An analytic function $f(z)$ is said to have a **pole** of order p at $z = z_0$ if in some neighborhood the point z_0 of a domain G where $f(z)$ is defined,

$$f(z) = \frac{g(z)}{(z - z_0)^p}, \quad (12)$$

where the function $g(z)$ is analytic at z_0 . When $p = 1$, the function $f(z)$ is said to have **simple pole** at $z = z_0$.

A meromorphic function A function $f(z)$ is said to be **meromorphic** if it is analytic everywhere in a domain G except for isolated points where its only singularities are poles. For example, the function $f(z) = 1/(z^2 + a^2) = 1/[(z - ia)(z + ia)]$ is a meromorphic function with simple poles at $z = \pm ia$.

The residue of $f(z)$ at a pole If a function has a pole of order p at $z = z_0$, then its **residue** at $z = z_0$ is given by

$$\text{Residue } (f(z) : z = z_0) = \lim_{z \rightarrow z_0} \left[\frac{1}{(p-1)!} \frac{d^{p-1}}{dz^{p-1}} (z - z_0)^p f(z) \right].$$

For example, the residues of $f(z) = 1/(z^2 + a^2)$ at its poles located at $z = \pm ia$ are

$$\text{Residue } (1/(z^2 + a^2) : z = ia) = -i/(2a)$$

and

$$\text{Residue } (1/(z^2 + a^2) : z = -ia) = i/(2a).$$

The Cauchy residue theorem Let Γ be a simple closed curve in the z -plane (a non-intersecting curve in the form of a simple loop). Denoting by $\int_{\Gamma} f(z)dz$ the integral of $f(z)$ around Γ in the counter-clockwise (positive) sense, the **Cauchy residue theorem** asserts that

$$\int_{\Gamma} f(z)dz = 2\pi i \times (\text{sum of residues of } f(z) \text{ inside } \Gamma). \quad (13)$$

So, for example, if Γ is *any* simple closed curve that contains *only* the residue of $f(z) = 1/(z^2 + a^2)$ located at $z = ia$, then

$$\int_{\Gamma} 1/(z^2 + a^2)dz = 2\pi i \times (-i/(2a)) = \pi/a.$$

Jordan's Lemma in Integral Form, and Its Consequences

This lemma take various forms, the most useful of which are as follows:

- (i) Let C_+ be a circular arc of radius R located in the first and/or second quadrants, with its center at the origin of the z -plane. Then if $f(z) \rightarrow 0$ uniformly as $R \rightarrow \infty$,

$$\lim_{R \rightarrow \infty} \int_{C_+} f(z)e^{imz} dz = 0, \quad \text{where } m > 0.$$

- (ii) Let C_- be a circular arc of radius R located in the third and/or fourth quadrant with its center at the origin of the z plane. Then if $f(z) \rightarrow 0$ uniformly as $R \rightarrow \infty$,

$$\lim_{R \rightarrow \infty} \int_{C_-} f(z)e^{-imz} dz = 0, \quad \text{where } m > 0.$$

- (iii) In a somewhat different form the lemma takes the form $\int_0^{\pi/2} e^{-k \sin \theta} d\theta \leq \frac{\pi}{2k} (1 - e^{-k})$.

The first two forms of Jordan's lemma are useful in general contour integration when establishing that the integral of an analytic function around a circular arc of radius R centered on the origin vanishes in the limit as $R \rightarrow \infty$. The third form is often used when estimating the magnitude of a complex function that is integrated around a quadrant. The form of Jordan's lemma to be used depends on the nature of the integrand to which it is to be applied. Later, result (iii) will be used when determining an inverse Laplace transform by means of the Laplace inversion integral.

The Fourier Transform and Its Inverse

In this handbook, the Fourier transform $F(\omega)$ of a suitably integrable function $f(x)$ is defined as

$$F(\omega) = \frac{1}{\sqrt{2\pi}} \int_{-\infty}^{\infty} f(x)e^{i\omega x} dx, \quad (14)$$

while the **inverse Fourier transform** becomes

$$f(x) = \frac{1}{\sqrt{2\pi}} \int_{-\infty}^{\infty} F(\omega) e^{-i\omega x} d\omega, \quad (15)$$

it being understood that when $f(x)$ is piecewise continuous with a piecewise continuous first derivative in any finite interval, that this last result is to be interpreted as

$$\frac{f(x_-) + f(x_+)}{2} = \frac{1}{\sqrt{2\pi}} \int_{-\infty}^{\infty} F(\omega) e^{-i\omega x} d\omega, \quad (16)$$

with $f(x_{\pm})$ the values of $f(x)$ on either side of a discontinuity in $f(x)$. Notice first that although $f(x)$ is real, its Fourier transform $F(\omega)$ may be complex. Although $F(\omega)$ may often be found by direct integration care is necessary, and it is often simpler to find it by converting the line integral defining $F(\omega)$ into a contour integral. The necessary steps involve (i) integrating $f(x)$ along the real axis from $-R$ to R , (ii) joining the two ends of this segment of the real axis by a semicircle of radius R with its center at the origin where the semicircle is either located in the upper half-plane, or in the lower half-plane, (iii) denoting this contour by Γ_R , and (iv) using the limiting form Γ of the contour Γ_R as $R \rightarrow \infty$ as the contour around which integration is to be performed. The choice of contour in the upper or lower half of the z -plane to be used will depend on the sign of the transform variable ω .

This same procedure is usually necessary when finding the inverse Fourier transform, because when $F(\omega)$ is complex direct integration of the inversion integral is not possible. The example that follows will illustrate the fact that considerable care is necessary when working with Fourier transforms. This is because when finding a Fourier transform, the transform variable ω often occurs in the form $|\omega|$, causing the transform to take one form when ω is positive, and another when it is negative.

Example: Let us find the Fourier transform of $f(x) = 1/(x^2 + a^2)$ where $a > 0$, the result of which is given in entry 1 of Table 20.1.

Replacing x by the complex variable z , the function $f(z) = e^{i\omega z}/(z^2 + a^2)$, the integrand in the Fourier transform, is seen to have simple poles at $z = ia$ and $z = -ia$, where the residues are, respectively, $-ie^{-\omega a}/(2a)$ and $ie^{\omega a}/(2a)$. For the time being, allowing C_R to be a semicircle in either the upper or the lower half of the z -plane with its center at the origin, we have

$$F(\omega) = \lim_{R \rightarrow \infty} \frac{1}{\sqrt{2\pi}} \int_{-R}^R \frac{e^{i\omega x}}{(x^2 + a^2)} dx + \lim_{R \rightarrow \infty} \frac{1}{\sqrt{2\pi}} \int_{C_R} \frac{e^{i\omega z}}{(z^2 + a^2)} dz.$$

To use the residue theorem we need to show the second integral vanishes in the limit as $R \rightarrow \infty$. On C_R we can set $z = Re^{i\theta}$, so $dz = iRe^{i\theta}d\theta$, showing that

$$\frac{1}{\sqrt{2\pi}} \int_{C_R} \frac{e^{i\omega z}}{(z^2 + a^2)} dz = \frac{1}{\sqrt{2\pi}} \int_{C_R} \frac{e^{i\omega R(\cos \theta + i \sin \theta)} iR e^{i\theta}}{(R^2 e^{2i\theta} + a^2)} e^{-\omega R \sin \theta} d\theta.$$

We now estimate the magnitude of the integral on the right by the result

$$\left| \frac{1}{\sqrt{2\pi}} \int_{C_R} \frac{e^{i\omega z}}{(z^2 + a^2)} dz \right| \leq \frac{1}{\sqrt{2\pi}} \frac{R}{|R^2 - a^2|} \int_{C_R} e^{-\omega R \sin \theta} d\theta.$$

The multiplicative factor involving R on the right will vanish as $R \rightarrow \infty$, so the integral around C_R will vanish if the integral on the right around C_R remains finite or vanishes as $R \rightarrow \infty$. There are two cases to consider, the first being when $\omega > 0$, and the second when $\omega < 0$. If $\omega = 0$ the integral will certainly vanish as $R \rightarrow \infty$, because then the integral around C_R becomes $\int_{C_R} d\theta = \pi$.

The case $\omega > 0$. The integral on the right around C_R will vanish in the limit as $R \rightarrow \infty$ provided $\sin \theta \geq 0$ because its integrand vanishes. This happens when C_R becomes the semicircle C_{R+} located in the upper half of the z -plane.

The case $\omega < 0$. The integral around C_R will vanish in the limit as $R \rightarrow \infty$, provided $\sin \theta \leq 0$ because its integrand vanishes. This happens when C_R becomes the semicircle C_{R-} located in the lower half of the z -plane.

We may now apply the residue theorem after proceeding to the limit as $R \rightarrow \infty$. When $\omega > 0$ we have $C_R = C_{R+}$, in which case only the pole at $z = ia$ lies inside the contour at which the residue is $-ie^{-\omega a}/(2a)$, so

$$\frac{1}{\sqrt{2\pi}} \int_{-\infty}^{\infty} \frac{e^{i\omega x}}{(x^2 + a^2)} dx = 2\pi i \times \frac{1}{\sqrt{2\pi}} \left[-\frac{ie^{-\omega a}}{2a} \right] = \sqrt{\frac{\pi}{2}} \frac{e^{-\omega a}}{a}, \quad (\omega > 0).$$

Similarly, when $\omega < 0$ we have $C_R = C_{R-}$, in which case only the pole at $z = -ia$ lies inside the contour at which the residue is $ie^{\omega a}/(2a)$. However, when integrating around C_{R-} in the positive (counterclockwise) sense, the integration along the x -axis occurs in the negative sense, that is from $x = R$ to $x = -R$, leading to the result

$$\frac{1}{\sqrt{2\pi}} \int_{\infty}^{-\infty} \frac{e^{i\omega x}}{(x^2 + a^2)} dx = 2\pi i \times \frac{1}{\sqrt{2\pi}} \left[\frac{ie^{\omega a}}{2a} \right] = -\sqrt{\frac{\pi}{2}} \frac{e^{\omega a}}{a}, \quad (\omega < 0).$$

Reversing the order of the limits in the integral, and compensating by reversing its sign, we arrive at the result

$$\frac{1}{\sqrt{2\pi}} \int_{-\infty}^{\infty} \frac{e^{i\omega x}}{(x^2 + a^2)} dx = \sqrt{\frac{\pi}{2}} \frac{e^{\omega a}}{a}, \quad (\omega < 0).$$

Combining the two results for positive and negative ω we have shown the Fourier transform $F(\omega)$ of $f(x) = 1/(x^2 + a^2)$ is

$$F(\omega) = \sqrt{\frac{\pi}{2}} \frac{e^{-a|\omega|}}{a}, \quad (a > 0).$$

The function $f(x)$ can be recovered from its Fourier transform $F(\omega)$ by means of the inversion integral, though this case is sufficiently simple that direct integration can be used.

$$f(x) = \frac{1}{\sqrt{2\pi}} \int_{-\infty}^{\infty} \sqrt{\frac{\pi}{2}} \frac{e^{-i\omega x} e^{-a|\omega|}}{a} d\omega = \frac{1}{2a} \int_{-\infty}^{\infty} e^{-a|\omega|} (\cos(\omega x) - i \sin(\omega x)) d\omega.$$

The imaginary part of the integrand is an odd function, so its integral vanishes. The real part of the integrand is an even function, so the interval of integration can be halved and replaced by $0 \leq \omega < \infty$, while the resulting integral is doubled, with the result that

$$f(x) = \frac{1}{a} \int_0^{\infty} e^{-a\omega} \cos(\omega x) d\omega = \frac{1}{x^2 + a^2}.$$

The Inverse Laplace Transform

Given an elementary function $f(x)$ for which the Laplace transform $F(s)$ exists, the determination of the form of $F(s)$ is usually a matter of routine integration. However, when finding $f(x)$ from $F(s)$ cannot be accomplished by use of a table of Laplace transform pairs and the properties of the transform, it becomes necessary to make use of the Laplace inversion formula

$$f(x) = \frac{1}{2\pi i} \int_{\gamma-i\infty}^{\gamma+i\infty} F(s) e^{sx} ds. \quad (17)$$

Here the real number γ must be chosen such that all the poles of the integrand lie to the left of the line $s = \gamma$ in the complex s -plane. This integral is to be interpreted as the limit as $R \rightarrow \infty$ of a contour integral around the contour shown in Figure 2. This is called the **Bromwich contour** after the Cambridge mathematician T.J.G.A. Bromwich who introduced it at the beginning of the last century.

Example: To illustrate the application of the Laplace inversion integral it will suffice to consider finding $f(x) = \mathcal{L}^{-1} \{1/\sqrt{s}\}$.

The function $1/\sqrt{s}$ has a branch point at the origin, so the Bromwich contour must be modified to make the function single valued inside the contour. We will use the contour shown in Figure 3, where the branch point is enclosed in a small circle about the origin while the complex s -plane is cut along the negative real axis to make the function single valued inside the contour.

Let C_{R1} denote the large circular arc and C_{R2} denote the small circle around the origin. Then on C_{R1} $s = \gamma + Re^{i\theta}$ for $\frac{\pi}{2} \leq \theta \leq \frac{3\pi}{2}$, and for subsequent use we now set $\theta = \frac{\pi}{2} + \phi$, so $s = \gamma + iRe^{i\phi}$ with $0 \leq \phi \leq \pi$. Consequently, $ds = -Re^{i\phi} d\phi$, with the result that $|ds| = Rd\phi$. Thus, when R is sufficiently large $|s| = |\gamma + iRe^{i\phi}| \geq ||Re^{i\phi}| - |\gamma|| = R - \gamma$.

Also for subsequent use, we need the result that

$$|e^{sx}| = \left| \exp \left[x (\gamma - R \sin \phi) + iR \cos \phi \right] \right| = e^{\gamma x} \exp [-Rx \sin \phi].$$

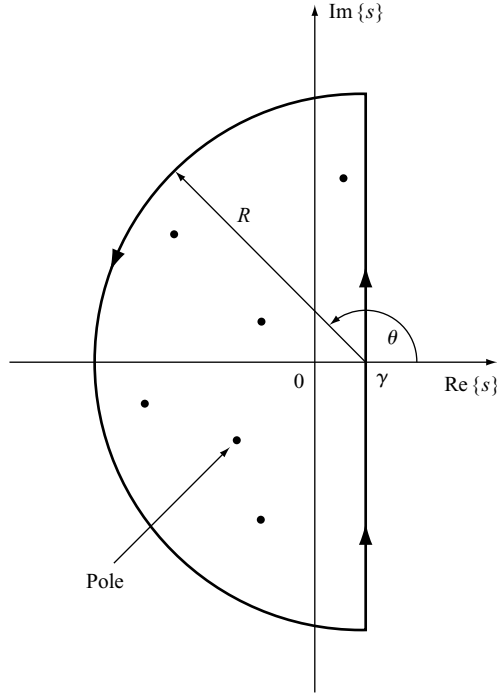

Figure 2. The Bromwich contour for the inversion of a Laplace transform.

The integral around the modified Bromwich contour is the sum of the integrals along each of its separate parts, so we now estimate the magnitudes of the respective integrals.

The magnitude of the integral around the large circular arc C_{R1} can be estimated as

$$I_R = \left| \int_{ABEF} \frac{e^{sx}}{\sqrt{s}} ds \right| \leq \int_{ABEF} \frac{|e^{sx}|}{|s|^{1/2}} |ds| \leq \frac{e^{\gamma x} R}{(R-\gamma)^{1/2}} \int_0^\pi \exp[-Rx \sin \phi] d\phi.$$

The symmetry of $\sin \phi$ about $\phi = \frac{1}{2}\pi$ allows the inequality to be rewritten as

$$I_R \leq \frac{2e^{\gamma x} R}{(R-\gamma)^{1/2}} \int_0^{\pi/2} \exp[-Rx \sin \phi] d\phi,$$

so after use of the Jordan inequality in form (iii), this becomes

$$I_R \leq \frac{\pi e^{\gamma x}}{(R-\gamma)^{1/2} x} (1 - e^{-Rx}), \quad \text{when } x > 0.$$

This shows that when $x > 0$, $\lim_{R \rightarrow \infty} I_R = 0$, so that the integral around C_{R1} vanishes in the limit as $R \rightarrow \infty$.

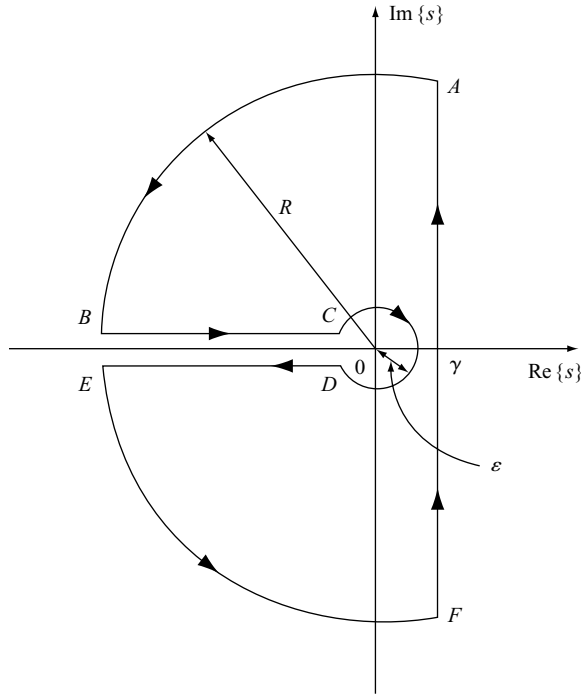

Figure 3. The modified Bromwich contour with an indentation and a cut.

On the small circle C_{R2} with radius ε we have $s = \varepsilon e^{i\theta}$, so $ds = i\varepsilon e^{i\theta} d\theta$ and $s^{1/2} = e^{i\theta/2} \sqrt{\varepsilon}$, so the integral around C_{R2} becomes

$$\int_{-\pi}^{\pi} \frac{1}{e^{i\theta/2} \sqrt{\varepsilon}} \exp[\varepsilon x (\cos \theta + i \sin \theta)] i\varepsilon e^{i\theta} d\theta,$$

but this vanishes as $\varepsilon \rightarrow 0$, so in the limit the integral around C_{R2} also vanishes.

Along the top BC of the branch cut $s = re^{i\pi} = -r$, so $\sqrt{s} = e^{\pi i/2} \sqrt{r} = i\sqrt{r}$, so that $ds = -dr$. Along the bottom BC of the branch cut the situation is different, because there $s = re^{-\pi i} = -r$, so $\sqrt{s} = e^{-\pi i/2} \sqrt{r} = -i\sqrt{r}$, where again $ds = -dr$.

The construction of the Bromwich contour has ensured that no poles lie inside it, so from the Cauchy residue theorem, in the limit as $R \rightarrow \infty$ and $\varepsilon \rightarrow 0$, the only contributions to the contour integral come from integration along opposite sides of the branch cut, so we arrive at the result

$$\frac{1}{2\pi i} \int_{\gamma-i\infty}^{\gamma+i\infty} \frac{e^{sx}}{\sqrt{s}} ds = \frac{1}{2\pi i} \left\{ - \int_{\infty}^0 \frac{ie^{-rx}}{\sqrt{r}} dr + \int_0^{\infty} \frac{ie^{-rx}}{\sqrt{r}} dr \right\} = \frac{1}{\pi} \int_0^{\infty} \frac{e^{-rx}}{\sqrt{r}} dr.$$

Finally, the change of variable $r = u^2$, followed by setting $v = u\sqrt{x}$, changes this result to

$$\frac{1}{2\pi i} \int_{\gamma-i\infty}^{\gamma+i\infty} \frac{e^{sx}}{\sqrt{s}} ds = \frac{2}{\pi\sqrt{x}} \int_0^\infty e^{-v^2} dv.$$

This last definite integral is a standard integral, and from entry **15.3.1(29)** we have $\int_0^\infty e^{-v^2} dv = \sqrt{\pi}/2$, so we have shown that

$$\mathcal{L}^{-1} \left\{ \frac{1}{\sqrt{s}} \right\} = \frac{1}{\sqrt{\pi x}}, \quad \text{for } \operatorname{Re}\{s\} > 0.$$

The inversion integral can generate an infinite series if an infinite number of isolated poles lie along a line parallel to the imaginary s -axis. This happens with $\mathcal{L}^{-1} \left\{ \frac{1}{s \cosh s} \right\}$, where the poles are actually located on the imaginary axis.

We omit the details, but straightforward reasoning using the standard Bromwich contour shows that

$$f(x) = \mathcal{L}^{-1} \left\{ \frac{1}{s \cosh s} \right\} = 1 + \frac{4}{\pi} \sum_{n=0}^{\infty} (-1)^{n+1} \frac{\cos [(2n+1)\pi x/2]}{2n+1}.$$

To understand why this periodic representation of $f(x)$ has occurred, notice that $F(s) = 1/[s \cosh s]$ is the Laplace transform of the piecewise continuous function

$$f(x) = \begin{cases} 0, & 0 < x < 1 \\ 2, & 1 < x < 3 \\ 0, & 3 < x < 4, \end{cases}$$

that is periodic with period 4 and defined for $x \geq 0$. So $f(x)$ is in fact the Fourier series representation of this function with period 4 when it is defined for all x . Here the term **period** is used in the usual sense that X is the period of $f(x)$ if $f(X+x) = f(x)$ is true for all x and X is the smallest value for which this result is true.

Index of Special Functions and Notations

<i>Notation</i>	<i>Name</i>	<i>Section of formula containing its definition</i>
$ a $	Absolute value of the real number a	1.1.2.1
$\operatorname{am} u$	Amplitude of an elliptic function	12.2.1.1.2
\sim	Asymptotic relationship	1.14.2.1
α	Modular angle of an elliptic integral	12.1.2
$\arg z$	Argument of complex number z	2.1.1.1
$A(x)$	$A(x) = 2P(x) - 1$; probability function	13.1.1.1.7
\mathbf{A}	Matrix	
\mathbf{A}^{-1}	Multiplicative inverse of a square matrix \mathbf{A}	1.5.1.1.9
\mathbf{A}^T	Transpose of matrix \mathbf{A}	1.5.1.1.7
$ \mathbf{A} $	Determinant associated with a square matrix \mathbf{A}	1.4.1.1
B_n	Bernoulli number	1.3.1.1
B_n^*	Alternative Bernoulli number	1.3.1.1.6
$B_n(x)$	Bernoulli polynomial	1.3.2.1.1
$B(x, y)$	Beta function	11.1.7.1
$\binom{n}{k}$	Binomial coefficient	1.2.1.1
	$\binom{n}{k} = \frac{n!}{k!(n-k)!}, \quad \binom{n}{0} = 1$	
$(a)_n$	Pochhammer symbol	
	$(a)_n = a(a+1)(a+2)\cdots(a+n-1)$	0.3
$C(x)$	Fresnel cosine integral	14.1.1.1.1
C_{ij}	Cofactor of element a_{ij} in a square matrix \mathbf{A}	1.4.2
${}^n C_m$ or ${}_n C_m$	Combination symbol ${}^n C_m = \binom{n}{m}$	1.6.2.1
$\operatorname{cn} u$	Jacobian elliptic function	12.2.1.1.4
$\operatorname{cn}^{-1} u$	Inverse Jacobian elliptic function	12.4.1.1.4
$\operatorname{curl} \mathbf{F} = \nabla \times \mathbf{F}$	Curl of vector \mathbf{F}	23.8.1.1.6
$\delta(x)$	Dirac delta function	19.1.3
δ_{ij}	Kronecker delta symbol	1.4.2.11
$D_n(x)$	Dirichlet kernel	1.13.1.10.3
$\operatorname{dn} u$	Jacobian elliptic function	12.2.1.1.5
$\operatorname{dn}^{-1} u$	Inverse Jacobian elliptic function	12.4.1.1.5
$\operatorname{div} \mathbf{F} = \nabla \cdot \mathbf{F}$	Divergence of vector \mathbf{F}	23.8.1.1.4
$e^{i\theta}$	Euler formula; $e^{i\theta} = \cos \theta + i \sin \theta$	2.1.1.2.1
e	Euler's constant	0.3
$Ei(x)$	Exponential integral	5.1.2.2
$E(\varphi, k)$	Incomplete elliptic integral of the second kind	12.1.1.1.5
$E(k), E'(k)$	Complete elliptic integrals of the second kind	13.1.1.1.8, 13.1.1.1.10

<i>Notation</i>	<i>Name</i>	<i>Section of formula containing its definition</i>
e^{Az}	Matrix exponential	1.5.4.1
$\operatorname{erf} x$	Error function	13.2.1.1
$\operatorname{erfc} x$	Complementary error function	13.2.1.1.4
E_n	Euler number	1.3.1.1
E_n^*	Alternative Euler number	1.3.1.1.6
$E_n(x)$	Euler polynomial	1.3.2.3.1
$f(x)$	A function of x	
$f'(x)$	First derivative df/dx	1.15.1.1.6
$f^{(n)}(x)$	n th derivative $d^n f/dx^n$	1.12.1.1
$f^{(n)}(x_0)$	n th derivative $d^n f/dx^n$ at x_0	1.12.1.1
$F(\varphi, k)$	Incomplete elliptic integral of the first kind	12.1.1.1.4
$\ \Phi_n\ $	Norm of $\Phi_n(x)$	18.1.1.1
$\operatorname{grad} \phi = \nabla \phi$	Gradient of the scalar function ϕ	23.8.1.6
$\Gamma(x)$	Gamma function	11.1.1.1
$\Gamma(a, x), \gamma(a, x)$	Incomplete gamma functions	11.1.8.9
γ	Euler–Mascheroni constant	1.11.1.1.7
$H(x)$	Heaviside step function	19.1.2.5
$H_n(x)$	Hermite polynomial	18.5.3
i	Imaginary unit	1.1.1.1
$\operatorname{Im}\{z\}$	Imaginary part of $z = x + iy$; $\operatorname{Im}\{z\} = y$	1.1.1.2
I	Unit (identity) matrix	1.5.1.1.3
$i^n \operatorname{erfc} x$	n th repeated integral of $\operatorname{erfc} x$	13.2.7.1.1
$I_{\pm \nu}(x)$	Modified Bessel function of the first kind of order ν	17.6.1.1
$\int f(x) dx$	Indefinite integral (antiderivative) of $f(x)$	1.15.2
$\int_a^b f(x) dx$	Definite integral of $f(x)$ from $x = a$ to $x = b$	1.15.2.5
$j_n(x)$	Spherical Bessel function	17.14.1
$J_{\pm \nu}(x)$	Bessel function of the first kind of order ν	17.1.1.1
k	Modulus of an elliptic integral	12.1.1.1
k'	Complementary modulus of an elliptic integral; $k' = \sqrt{1 - k^2}$	12.1.1.1
K (k), K' (k)	Complete elliptic integrals of the first kind	12.1.1.1.7, 12.1.1.1.9
$k_\nu(x)$	Modified Bessel function of the second kind of order ν	17.6.1.1
$\mathcal{L}[f(x); s]$	Laplace transform of $f(x)$	19.1.1
$L_n(x)$	Laguerre polynomial	18.4.1
$L_n^{(\alpha)}$	Generalized Laguerre polynomial	18.4.8.2
$\log_a x$	Logarithm of x to the base a	2.2.1.1
$\ln x$	Natural logarithm of x (to the base e)	2.2.1.1
M_{ij}	Minor of element a_{ij} in a square matrix A	1.4.2
$n!$	Factorial n ; $n! = 1 \cdot 2 \cdot 3 \cdots n$; $0! = 1$	1.2.1.1
$(2n)!!$	Double factorial; $(2n)!! = 2 \cdot 4 \cdot 6 \cdots (2n)$	15.2.1
$(2n - 1)!!$	Double factorial; $(2n - 1)!! = 1 \cdot 3 \cdot 5 \cdots (2n - 1)$	15.2.1
$\left[\frac{n}{2} \right]$	Integral part of $n/2$	18.2.4.1.1
${}^n P_m$ or ${}_n P_m$	Permutation symbol; ${}^n P_m = \frac{n!}{(n - m)!}$	1.6.1.1.3

<i>Notation</i>	<i>Name</i>	<i>Section of formula containing its definition</i>
$P_n(x)$	Legendre polynomial	18.2.1
$P_m^n(x)$	First solution of the associated Legendre equation	18.2.10.1
$P_n^{(\alpha, \beta)}(x)$	Jacobi polynomial of degree n	18.6.1
$P(x)$	Normal probability distribution	13.1.1.1.5
$\prod_{k=1}^n u_k$	Product symbol; $\prod_{k=1}^n u_k = u_1 u_2 \cdots u_n$	1.9.1.1.1
P.V. $\int_{-\infty}^{\infty} f(x) dx$	Cauchy principal value of the integral	1.15.4.IV
π	Ratio of the circumference of a circle to its diameter	0.3
$\Pi(x)$	pi function	11.1.1.1
$\Pi(\varphi, n, k)$	Incomplete elliptic integral of the third kind	12.1.1.1.6
$\psi(z)$	psi (digamma) function	11.1.6.1
$Q(x)$	Probability function; $Q(x) = 1 - P(x)$	13.1.1.1.6
$Q(x)$	Quadratic form	1.5.2.1
$Q_n(x)$	Legendre function of the second kind	18.2.7
$Q_m^n(x)$	Second solution of the associated Legendre equation	18.2.10.1
r	Modulus of $z = x + iy$; $r = (x^2 + y^2)^{1/2}$	
$\operatorname{Re}\{z\}$	Real part of $z = x + iy$; $\operatorname{Re}\{z\} = x$	1.1.1.2
$\operatorname{sgn}(x)$	Sign of x	
$\operatorname{sn} u$	Jacobian elliptic function	12.2.1.1.3
$\operatorname{sn}^{-1} u$	Inverse Jacobian elliptic function	12.4.1.1.3
$S(x)$	Fresnel sine integral	14.1.1.1.2
$\operatorname{Si}(x)$, $\operatorname{Ci}(x)$	Sine and cosine integrals	14.2.1
$\sum_{k=m}^n a_k$	Summation symbol; $\sum_{k=m}^n a_k = a_m + a_{m+1} + \cdots + a_n$	1.2.3
	and if $n < m$ we define $\sum_{k=m}^n a_k = 0$.	
$\sum_{k=m}^{\infty} a_k (x - x_0)^k$	Power series expanded about x_0	1.11.1.1.1
$T_n(x)$	Chebyshev polynomial	18.3.1.1
$\operatorname{tr} \mathbf{A}$	Trace of a square matrix \mathbf{A}	15.1.1.10
$U_n(x)$	Chebyshev polynomial	18.3.11
$x = f^{-1}(y)$	Function inverse to $y = f(x)$	1.11.1.8
$Y_v(x)$	Bessel function of the second kind of order v	17.1.1.1
$Y_n^m(\theta, \phi)$	Spherical harmonic	18.2.10.1
$y_n(x)$	Spherical Bessel function	17.14.1
z	Complex number $z = x + iy$	1.1.1.1
$ z $	Modulus of $z = x + iy$; $r = z = (x^2 + y^2)^{1/2}$	1.1.1.1
\bar{z}	Complex conjugate of $z = x + iy$; $\bar{z} = x - iy$	1.1.1.1
$z_b\{x[n]\}$	bilateral z -transform	26.1
$z_u\{x[n]\}$	unilateral z -transform	26.1

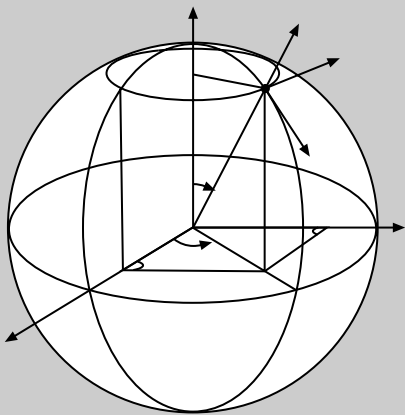

Chapter 0

Quick Reference List of Frequently Used Data

0.1 USEFUL IDENTITIES

0.1.1 Trigonometric Identities

$$\sin^2 x + \cos^2 x = 1$$

$$\sec^2 x = 1 + \tan^2 x$$

$$\csc^2 x = 1 + \cot^2 x$$

$$\sin 2x = 2 \sin x \cos x$$

$$\begin{aligned} \cos 2x &= \cos^2 x - \sin^2 x \\ &= 1 - 2 \sin^2 x \\ &= 2 \cos^2 x - 1 \end{aligned}$$

$$\sin^2 x = \frac{1}{2} (1 - \cos 2x)$$

$$\cos^2 x = \frac{1}{2} (1 + \cos 2x)$$

$$\sin(x + y) = \sin x \cos y + \cos x \sin y$$

$$\sin(x - y) = \sin x \cos y - \cos x \sin y$$

$$\cos(x + y) = \cos x \cos y - \sin x \sin y$$

$$\cos(x - y) = \cos x \cos y + \sin x \sin y$$

$$\tan(x + y) = \frac{\tan x + \tan y}{1 - \tan x \tan y}$$

$$\tan(x - y) = \frac{\tan x - \tan y}{1 + \tan x \tan y}$$

$$\cot(x + y) = \frac{\cot x \cot y - 1}{\cot x + \cot y}$$

$$\cot(x - y) = \frac{\cot x \cot y + 1}{\cot y - \cot x}$$

0.1.2 Hyperbolic Identities

$$\cosh^2 x - \sinh^2 x = 1$$

$$\operatorname{sech}^2 x = 1 - \tanh^2 x$$

$$\operatorname{csch}^2 x = \operatorname{coth}^2 x - 1$$

$$\sinh 2x = 2 \sinh x \cosh x$$

$$\cosh 2x = \cosh^2 x + \sinh^2 x$$

$$= 1 + 2 \sinh^2 x$$

$$= 2 \cosh^2 x - 1$$

$$\sinh^2 x = \frac{1}{2} (\cosh 2x - 1)$$

$$\cosh^2 x = \frac{1}{2} (\cosh 2x + 1)$$

$$\sinh(x + y) = \sinh x \cosh y + \cosh x \sinh y$$

$$\sinh(x - y) = \sinh x \cosh y - \cosh x \sinh y$$

$$\cosh(x + y) = \cosh x \cosh y + \sinh x \sinh y$$

$$\cosh(x - y) = \cosh x \cosh y - \sinh x \sinh y$$

$$\tanh(x + y) = \frac{\tanh x + \tanh y}{1 + \tanh x \tanh y}$$

$$\tanh(x - y) = \frac{\tanh x - \tanh y}{1 - \tanh x \tanh y}$$

$$\operatorname{coth}(x + y) = \frac{\operatorname{coth} x \operatorname{coth} y + 1}{\operatorname{coth} x + \operatorname{coth} y}$$

$$\operatorname{coth}(x - y) = \frac{1 - \operatorname{coth} x \operatorname{coth} y}{\operatorname{coth} x - \operatorname{coth} y}$$

$$\operatorname{arsinh} \frac{x}{a} = \ln \left[\frac{x + (a^2 + x^2)^{1/2}}{a} \right] \quad [-\infty < x/a < \infty]$$

$$\operatorname{arcosh} \frac{x}{a} = \ln \left[\frac{x + (x^2 - a^2)^{1/2}}{a} \right] \quad [x/a > 1]$$

$$\operatorname{artanh} \frac{x}{a} = \frac{1}{2} \ln \left[\frac{a + x}{a - x} \right] \quad [x^2 < a^2]$$

0.2 COMPLEX RELATIONSHIPS

$$e^{ix} = \cos x + i \sin x$$

$$\sin x = \frac{e^{ix} - e^{-ix}}{2i}$$

$$\cos x = \frac{e^{ix} + e^{-ix}}{2}$$

$$(\cos x + i \sin x)^n = \cos nx + i \sin nx$$

$$\sin nx = \operatorname{Im}\{(\cos x + i \sin x)^n\}$$

$$\cos nx = \operatorname{Re}\{(\cos x + i \sin x)^n\}$$

$$\sinh x = \frac{e^x - e^{-x}}{2}$$

$$\cosh x = \frac{e^x + e^{-x}}{2}$$

$$\sin ix = i \sinh x$$

$$\cos ix = \cosh x$$

$$\sinh ix = i \sin x$$

$$\cosh ix = \cos x$$

0.3 CONSTANTS, BINOMIAL COEFFICIENTS AND THE POCHHAMMER SYMBOL

$$e = 2.7182\ 81828\ 45904$$

$$\gamma = 0.5772\ 15664\ 90153$$

$$\pi = 3.1415\ 92653\ 58979$$

$$(2\pi)^{-1/2} = 0.3989\ 42280\ 40143$$

$$\log_{10} e = 0.4342\ 94481\ 90325$$

$$\Gamma\left(\frac{1}{2}\right) = \pi^{1/2} = 1.7724\ 53850\ 90551$$

$$\ln 10 = 2.3025\ 85092\ 99404$$

Binomial Coefficients

$$\binom{p}{n} = \frac{p(p-1)\dots(p-n+1)}{n!} = \frac{p!}{n!(p-n)!}, \quad \binom{p}{0} = 1 \quad [n = 1, 2, \dots, p \geq n]$$

Pochhammer Symbol

$$(a)_n = a(a+1)(a+2)\dots(a+n-1) = \Gamma(a+n)/\Gamma(a)$$

0.4 DERIVATIVES OF ELEMENTARY FUNCTIONS

$f(x)$	$f'(x)$	$f(x)$	$f'(x)$
x^n	nx^{n-1}	$\sinh ax$	$a \cosh ax$
e^{ax}	ae^{ax}	$\cosh ax$	$a \sinh ax$
$\ln x$	$1/x$	$\tanh ax$	$a \operatorname{sech}^2 ax$
$\sin ax$	$a \cos ax$	$\operatorname{csch} ax$	$-a \operatorname{csch} ax \operatorname{coth} ax$
$\cos ax$	$-a \sin ax$	$\operatorname{sech} ax$	$-a \operatorname{sech} ax \tanh ax$
$\tan ax$	$a \sec^2 ax$	$\operatorname{coth} ax$	$-a \operatorname{csch}^2 ax$
$\csc ax$	$-a \csc ax \cot ax$	$\operatorname{arcsinh} \frac{x}{a}$	$1/\sqrt{x^2 + a^2}$
$\sec ax$	$a \sec ax \tan ax$		
$\cot ax$	$-a \csc^2 ax$	$\operatorname{arccosh} \frac{x}{a}$	$\begin{cases} 1/\sqrt{x^2 - a^2} & \text{for } \operatorname{arccosh} \frac{x}{a} > 0, \frac{x}{a} > 1, \\ -1/\sqrt{x^2 - a^2} & \text{for } \operatorname{arccosh} \frac{x}{a} < 0, \frac{x}{a} > 1. \end{cases}$
$\arcsin \frac{x}{a}$	$1/\sqrt{a^2 - x^2}$		
$\arccos \frac{x}{a}$	$-1/\sqrt{a^2 - x^2}$		
$\arctan \frac{x}{a}$	$a/(a^2 + x^2)$	$\operatorname{arctanh} \frac{x}{a}$	$a/(a^2 - x^2) \quad [x^2 < a^2]$

0.5 RULES OF DIFFERENTIATION AND INTEGRATION

$$1. \quad \frac{d}{dx}(u + v) = \frac{du}{dx} + \frac{dv}{dx} \quad (\text{sum})$$

$$2. \quad \frac{d}{dx}(uv) = u \frac{dv}{dx} + v \frac{du}{dx} \quad (\text{product})$$

$$3. \quad \frac{d}{dx} \left(\frac{u}{v} \right) = \left(v \frac{du}{dx} - u \frac{dv}{dx} \right) / v^2 \quad \text{for } v \neq 0 \quad (\text{quotient})$$

$$4. \quad \frac{d}{dx}[f\{g(x)\}] = f'\{g(x)\} \frac{dg}{dx} \quad (\text{function of a function})$$

$$5. \quad \int (u + v) dx = \int u dx + \int v dx \quad (\text{sum})$$

$$6. \quad \int u dv = uv - \int v du \quad (\text{integration by parts})$$

$$7. \quad \frac{d}{d\alpha} \int_{\phi(\alpha)}^{\psi(\alpha)} f(x, \alpha) dx = \left(\frac{d\psi}{d\alpha} \right) f(\psi, \alpha) - \left(\frac{d\phi}{d\alpha} \right) f(\phi, \alpha) + \int_{\phi(\alpha)}^{\psi(\alpha)} \frac{\partial f}{\partial \alpha} dx$$

(differentiation of an integral containing a parameter)

0.6 STANDARD INTEGRALS

Common standard forms

$$1. \quad \int x^n dx = \frac{1}{n+1} x^{n+1} \quad [n \neq -1]$$

$$2. \quad \int \frac{1}{x} dx = \ln |x| = \begin{cases} \ln x, & x > 0 \\ \ln(-x), & x < 0 \end{cases}$$

$$3. \quad \int e^{ax} dx = \frac{1}{a} e^{ax}$$

$$4. \quad \int a^x dx = \frac{a^x}{\ln a} \quad [a \neq 1, a > 0]$$

$$5. \quad \int \ln x dx = x \ln x - x$$

$$6. \quad \int \sin ax dx = -\frac{1}{a} \cos ax$$

$$7. \quad \int \cos ax dx = \frac{1}{a} \sin ax$$

$$8. \quad \int \tan ax dx = -\frac{1}{a} \ln |\cos ax|$$

$$9. \quad \int \sinh ax dx = \frac{1}{a} \cosh ax$$

$$10. \quad \int \cosh ax dx = \frac{1}{a} \sinh ax$$

11. $\int \tanh ax \, dx = \frac{1}{a} \ln |\cosh ax|$
12. $\int \frac{1}{\sqrt{a^2 - x^2}} \, dx = \arcsin \frac{x}{a} \quad [x^2 \leq a^2]$
13. $\int \frac{1}{\sqrt{x^2 - a^2}} \, dx = \operatorname{arccosh} \frac{x}{a} = \ln |x + \sqrt{x^2 - a^2}| \quad [a^2 \leq x^2]$
14. $\int \frac{1}{\sqrt{a^2 + x^2}} \, dx = \operatorname{arcsinh} \frac{x}{a} = \ln |x + \sqrt{a^2 + x^2}|$
15. $\int \frac{1}{x^2 + a^2} \, dx = \frac{1}{a} \arctan \frac{x}{a}$
16. $\int \frac{dx}{a^2 - b^2x^2} = \frac{1}{2ab} \ln \left| \frac{a + bx}{a - bx} \right| = \frac{1}{ab} \operatorname{arctanh} \frac{bx}{a} \quad [a^2 > b^2x^2]$

Integrands involving algebraic functions

17. $\int (a + bx)^n \, dx = \frac{(a + bx)^{n+1}}{b(n+1)} \quad [n \neq -1]$
18. $\int \frac{1}{a + bx} \, dx = \frac{1}{b} \ln |a + bx|$
19. $\int x(a + bx)^n \, dx = \frac{(a + bx)^{n+1}}{b^2} \left(\frac{a + bx}{n+2} - \frac{a}{n+1} \right) \quad [n \neq -1, -2]$
20. $\int \frac{x}{a + bx} \, dx = \frac{x}{b} - \frac{a}{b^2} \ln |a + bx|$
21. $\int \frac{x^2}{a + bx} \, dx = \frac{1}{b^3} \left[\frac{1}{2}(a + bx)^2 - 2a(a + bx) + a^2 \ln |a + bx| \right]$
22. $\int \frac{x}{(a + bx)^2} \, dx = \frac{1}{b^2} \left(\frac{a}{a + bx} + \ln |a + bx| \right)$
23. $\int \frac{x^2}{(a + bx)^2} \, dx = \frac{1}{b^3} \left(a + bx - \frac{a^2}{a + bx} - 2a \ln |a + bx| \right)$
24. $\int \frac{1}{x(a + bx)} \, dx = \frac{1}{a} \ln \left| \frac{x}{a + bx} \right|$
25. $\int \frac{1}{x^2(a + bx)} \, dx = -\frac{1}{ax} + \frac{b}{a^2} \ln \left| \frac{a + bx}{x} \right|$
26. $\int \frac{1}{x(a + bx)^2} \, dx = \frac{1}{a(a + bx)} + \frac{1}{a^2} \ln \left| \frac{x}{a + bx} \right|$
27. $\int \frac{1}{x\sqrt{a + bx}} \, dx = \begin{cases} \frac{1}{\sqrt{a}} \ln \left| \frac{\sqrt{a + bx} - \sqrt{a}}{\sqrt{a + bx} + \sqrt{a}} \right| & \text{if } a > 0 \\ \frac{2}{\sqrt{-a}} \arctan \sqrt{\frac{a + bx}{-a}} & \text{if } a < 0 \end{cases}$

28. $\int \frac{1}{x^2\sqrt{a+bx}} dx = -\frac{\sqrt{a+bx}}{ax} - \frac{b}{2a} \int \frac{1}{x\sqrt{a+bx}} dx$
29. $\int \frac{x}{\sqrt{a+bx}} dx = \frac{2}{3b^2} (bx - 2a) \sqrt{a+bx}$
30. $\int \frac{x^2 dx}{\sqrt{a+bx}} = \frac{2}{15b^3} (8a^2 + 3b^2x^2 - 4abx) \sqrt{a+bx}$
31. $\int \sqrt{(a+bx)^n} dx = \frac{2}{b} \frac{(a+bx)^{1+n/2}}{n+2} \quad [n \neq -2]$
32. $\int \frac{\sqrt{a+bx}}{x} dx = 2\sqrt{a+bx} + a \int \frac{1}{x\sqrt{a+bx}} dx$
33. $\int x\sqrt{a+bx} dx = \frac{2}{15b^2} (3bx - 2a)(a+bx)^{3/2}$
34. $\int \sqrt{a^2+x^2} dx = \frac{x}{2} \sqrt{a^2+x^2} + \frac{a^2}{2} \operatorname{arcsinh} \frac{x}{a}$
35. $\int x^2 \sqrt{a^2+x^2} dx = \frac{x}{8} (a^2+2x^2) \sqrt{a^2+x^2} - \frac{a^4}{8} \operatorname{arcsinh} \frac{x}{a}$
36. $\int \frac{\sqrt{a^2+x^2}}{x} dx = \sqrt{a^2+x^2} - a \ln \left[\frac{(a^2+x^2)^{1/2} + a}{x} \right]$
37. $\int \frac{\sqrt{a^2+x^2}}{x^2} dx = \ln[(a^2+x^2)^{1/2} + x] - \frac{\sqrt{a^2+x^2}}{x}$
38. $\int \frac{1}{x\sqrt{a^2+x^2}} dx = -\frac{1}{a} \ln \left[\frac{(a^2+x^2)^{1/2} + a}{x} \right]$
39. $\int \frac{1}{x^2\sqrt{a^2+x^2}} dx = -\frac{\sqrt{a^2+x^2}}{a^2x}$
40. $\int \sqrt{a^2-x^2} dx = \frac{x}{2} \sqrt{a^2-x^2} + \frac{a^2}{2} \arcsin \frac{x}{|a|} \quad [x^2 < a^2]$
41. $\int \frac{1}{x\sqrt{a^2-x^2}} dx = -\frac{1}{a} \ln \left[\frac{(a^2-x^2)^{1/2} + a}{x} \right] \quad [x^2 < a^2]$
42. $\int \sqrt{x^2-a^2} dx = \frac{x}{2} \sqrt{x^2-a^2} - \frac{a^2}{2} \ln [(x^2-a^2)^{1/2} + x] \quad [a^2 < x^2]$
43. $\int \frac{\sqrt{x^2-a^2}}{x} dx = \sqrt{x^2-a^2} - a \operatorname{arcsec} \left| \frac{x}{a} \right| \quad [a^2 \leq x^2]$
44. $\int \frac{1}{x^2\sqrt{x^2-a^2}} dx = \frac{\sqrt{x^2-a^2}}{a^2x} \quad [a^2 < x^2]$

$$45. \int \frac{1}{(a^2 + x^2)^2} dx = \frac{x}{2a^2(a^2 + x^2)} + \frac{1}{2a^3} \arctan \frac{x}{a}$$

$$46. \int \frac{1}{(a^2 - x^2)^2} dx = \frac{x}{2a^2(a^2 - x^2)} - \frac{1}{4a^3} \ln \left[\frac{x - a}{x + a} \right] \quad [x^2 < a^2]$$

Integrands involving trigonometric functions, powers of x , and exponentials

$$47. \int \sin ax \, dx = -\frac{1}{a} \cos ax$$

$$48. \int \sin^2 ax \, dx = \frac{x}{2} - \frac{\sin 2ax}{4a}$$

$$49. \int \cos ax \, dx = \frac{1}{a} \sin ax$$

$$50. \int \cos^2 ax \, dx = \frac{x}{2} + \frac{\sin 2ax}{4a}$$

$$51. \int \sin ax \sin bx \, dx = \frac{\sin(a - b)x}{2(a - b)} - \frac{\sin(a + b)x}{2(a + b)} \quad [a^2 \neq b^2]$$

$$52. \int \cos ax \cos bx \, dx = \frac{\sin(a - b)x}{2(a - b)} + \frac{\sin(a + b)x}{2(a + b)} \quad [a^2 \neq b^2]$$

$$53. \int \sin ax \cos bx \, dx = -\frac{\cos(a + b)x}{2(a + b)} - \frac{\cos(a - b)x}{2(a - b)} \quad [a^2 \neq b^2]$$

$$54. \int \sin ax \cos ax \, dx = \frac{\sin^2 ax}{2a}$$

$$55. \int x \sin ax \, dx = \frac{\sin ax}{a^2} - \frac{x \cos ax}{a}$$

$$56. \int x^2 \sin ax \, dx = \frac{2x \sin ax}{a^2} - \frac{(a^2 x^2 - 2)}{a^3} \cos ax$$

$$57. \int x \cos ax \, dx = \frac{x \sin ax}{a} + \frac{1}{a^2} \cos ax$$

$$58. \int x^2 \cos ax \, dx = \left(\frac{x^2}{a} - \frac{2}{a^3} \right) \sin ax + \frac{2x \cos ax}{a^2}$$

$$59. \int e^{ax} \sin bx \, dx = \frac{e^{ax}}{a^2 + b^2} (a \sin bx - b \cos bx)$$

$$60. \int e^{ax} \cos bx \, dx = \frac{e^{ax}}{a^2 + b^2} (a \cos bx + b \sin bx)$$

$$61. \int \sec ax \, dx = \frac{1}{a} \ln |\sec ax + \tan ax|$$

$$62. \int \csc ax \, dx = \frac{1}{a} \ln |\csc ax - \cot ax|$$

$$63. \int \cot ax \, dx = \frac{1}{a} \ln |\sin ax|$$

$$64. \int \tan^2 ax \, dx = \frac{1}{a} \tan ax - x$$

$$65. \int \sec^2 ax \, dx = \frac{1}{a} \tan ax$$

$$66. \int \csc^2 ax \, dx = -\frac{1}{a} \cot ax$$

$$67. \int \cot^2 ax \, dx = -\frac{1}{a} \cot ax - x$$

Integrands involving inverse trigonometric functions

$$68. \int \arcsin ax \, dx = x \arcsin ax + \frac{1}{a} \sqrt{1 - a^2 x^2} \quad [a^2 x^2 \leq 1]$$

$$69. \int \arccos ax \, dx = x \arccos ax - \frac{1}{a} \sqrt{1 - a^2 x^2} \quad [a^2 x^2 \leq 1]$$

$$70. \int \arctan ax \, dx = x \arctan ax - \frac{1}{2a} \ln(1 + a^2 x^2)$$

Integrands involving exponential and logarithmic functions

$$71. \int e^{ax} \, dx = \frac{1}{a} e^{ax}$$

$$72. \int b^{ax} \, dx = \frac{1}{a \ln b} b^{ax} \quad [b > 0, b \neq 1]$$

$$73. \int x e^{ax} \, dx = \frac{e^{ax}}{a^2} (ax - 1)$$

$$74. \int \ln ax \, dx = x \ln ax - x$$

$$75. \int \frac{\ln ax}{x} \, dx = \frac{1}{2} (\ln ax)^2$$

$$76. \int \frac{1}{x \ln ax} \, dx = \ln |\ln ax|$$

Integrands involving hyperbolic functions

$$77. \int \sinh ax \, dx = \frac{1}{a} \cosh ax$$

$$78. \int \sinh^2 ax \, dx = \frac{\sinh 2ax}{4a} - \frac{x}{2}$$

$$79. \int x \sinh ax \, dx = \frac{x}{a} \cosh ax - \frac{1}{a^2} \sinh ax$$

$$80. \int \cosh ax \, dx = \frac{1}{a} \sinh ax$$

81. $\int \cosh^2 ax \, dx = \frac{\sinh 2ax}{4a} + \frac{x}{2}$
82. $\int x \cosh ax \, dx = \frac{x}{a} \sinh ax - \frac{1}{a^2} \cosh ax$
83. $\int e^{ax} \sinh bx \, dx = \frac{e^{ax}}{2} \left(\frac{e^{bx}}{a+b} - \frac{e^{-bx}}{a-b} \right) \quad [a^2 \neq b^2]$
84. $\int e^{ax} \cosh bx \, dx = \frac{e^{ax}}{2} \left(\frac{e^{bx}}{a+b} + \frac{e^{-bx}}{a-b} \right) \quad [a^2 \neq b^2]$
85. $\int e^{ax} \sinh ax \, dx = \frac{1}{4a} e^{2ax} - \frac{1}{2} x$
86. $\int e^{ax} \cosh ax \, dx = \frac{1}{4a} e^{2ax} + \frac{1}{2} x$
87. $\int \tanh ax \, dx = \frac{1}{a} \ln (\cosh ax)$
88. $\int \tanh^2 ax \, dx = x - \frac{1}{a} \tanh ax$
89. $\int \coth ax \, dx = \frac{1}{a} \ln |\sinh ax|$
90. $\int \coth^2 ax \, dx = x - \frac{1}{a} \coth ax$
91. $\int \operatorname{sech} ax \, dx = \frac{2}{a} \arctan e^{ax}$
92. $\int \operatorname{sech}^2 ax \, dx = \frac{1}{a} \tanh ax$
93. $\int \operatorname{csch} ax \, dx = \frac{1}{a} \ln \left| \tanh \frac{ax}{2} \right|$
94. $\int \operatorname{csch}^2 ax \, dx = -\frac{1}{a} \coth ax$

Integrands involving inverse hyperbolic functions

95. $\int \operatorname{arcsinh} \frac{x}{a} \, dx = x \operatorname{arcsinh} \frac{x}{a} - (a^2 + x^2)^{1/2}$
 $= x \ln \left[\frac{x + (a^2 + x^2)^{1/2}}{a} \right] - (a^2 + x^2)^{1/2} \quad [a > 0]$
96. $\int \operatorname{arcosh} \frac{x}{a} \, dx = x \operatorname{arcosh} \frac{x}{a} - (x^2 - a^2)^{1/2}$
 $= x \ln \left[\frac{x + (x^2 - a^2)^{1/2}}{a} \right] - (x^2 - a^2)^{1/2} \quad \left[\operatorname{arcosh} \frac{x}{a} > 0, x^2 > a^2 \right]$
 $= x \operatorname{arcosh} \frac{x}{a} + (x^2 - a^2)^{1/2} \quad \left[\operatorname{arcosh} \frac{x}{a} < 0, x^2 > a^2 \right]$

$$= x \ln \left[\frac{x + (x^2 - a^2)^{1/2}}{a} \right] + (x^2 - a^2)^{1/2}$$

97. $\int \operatorname{arctanh} \frac{x}{a} dx = x \operatorname{arctanh} \frac{x}{a} + \frac{a}{2} \ln(a^2 - x^2)$
 $= \frac{x}{2} \ln \left(\frac{a+x}{a-x} \right) + \frac{a}{2} \ln(a^2 - x^2) \quad [x^2 < a^2]$

98. $\int x \operatorname{arcsinh} \frac{x}{a} dx = \left(\frac{x^2}{2} + \frac{a^2}{4} \right) \operatorname{arcsinh} \frac{x}{a} - \frac{x}{4} \sqrt{a^2 + x^2}$
 $= \left(\frac{x^2}{2} + \frac{a^2}{4} \right) \ln \left[\frac{x + (a^2 + x^2)^{1/2}}{a} \right] - \frac{x}{4} \sqrt{a^2 + x^2} \quad [a > 0]$

99. $\int x \operatorname{arccosh} \frac{x}{a} dx = \left(\frac{x^2}{2} - \frac{a^2}{4} \right) \operatorname{arccosh} \frac{x}{a} - \frac{x}{4} \sqrt{x^2 - a^2}$
 $= \left(\frac{x^2}{2} - \frac{a^2}{4} \right) \ln \left[\frac{x + (x^2 - a^2)^{1/2}}{a} \right] - \frac{x}{4} \sqrt{x^2 - a^2} \quad [\operatorname{arccosh} \frac{x}{a} > 0, x^2 > a^2]$
 $= \left(\frac{x^2}{2} - \frac{a^2}{4} \right) \operatorname{arccosh} \frac{x}{a} + \frac{x}{4} \sqrt{x^2 - a^2} \quad [\operatorname{arccosh} \frac{x}{a} < 0, x^2 > a^2]$
 $= \left(\frac{x^2}{2} - \frac{a^2}{4} \right) \ln \left[\frac{x + (x^2 - a^2)^{1/2}}{a} \right] + \frac{x}{4} \sqrt{x^2 - a^2}$

100. $\int x \operatorname{arctanh} \frac{x}{a} dx = \left(\frac{x^2 - a^2}{2} \right) \operatorname{arctanh} \frac{x}{a} + \frac{1}{2} ax$
 $= \left(\frac{x^2 - a^2}{4} \right) \ln \left[\frac{a+x}{a-x} \right] + \frac{1}{2} ax \quad [x^2 < a^2]$

0.7 STANDARD SERIES

Power series

1. $(1 \pm x)^{-1} = 1 \mp x + x^2 \mp x^3 + x^4 \mp \dots \quad [|x| < 1]$
2. $(1 \pm x)^{-2} = 1 \mp 2x + 3x^2 \mp 4x^3 + 5x^4 \mp \dots \quad [|x| < 1]$
3. $(1 \pm x^2)^{-1} = 1 \mp x^2 + x^4 \mp x^6 + x^8 \mp \dots \quad [|x| < 1]$
4. $(1 \pm x^2)^{-2} = 1 \mp 2x^2 + 3x^4 \mp 4x^6 + 5x^8 \mp \dots \quad [|x| < 1]$
5. $(1+x)^\alpha = 1 + \alpha x + \frac{\alpha(\alpha-1)}{2!} x^2 + \frac{\alpha(\alpha-1)(\alpha-2)}{3!} x^3 + \dots$
 $= 1 + \sum_{n=1}^{\infty} \frac{\alpha(\alpha-1)(\alpha-2)\cdots(\alpha-n+1)}{n!} x^n, \alpha \text{ real and } |x| < 1.$
(the binomial series)

These results may be extended by replacing x with $\pm x^k$ and making the appropriate modification to the convergence condition $|x| < 1$. Thus, replacing x with $\pm x^2/4$ and setting $\alpha = -1/2$ in power series 5 gives

$$\left(1 \pm \frac{x^2}{4}\right)^{-1/2} = 1 \mp \frac{1}{8}x^2 + \frac{3}{128}x^4 \mp \frac{5}{1024}x^6 + \dots,$$

for $|x^2/4| < 1$, which is equivalent to $|x| < 2$.

Trigonometric series

6. $\sin x = x - \frac{x^3}{3!} + \frac{x^5}{5!} - \frac{x^7}{7!} + \dots \quad [|x| < \infty]$
7. $\cos x = 1 - \frac{x^2}{2!} + \frac{x^4}{4!} - \frac{x^6}{6!} + \dots \quad [|x| < \infty]$
8. $\tan x = x + \frac{x^3}{3} + \frac{2}{15}x^5 - \frac{17}{315}x^7 + \frac{62}{2835}x^9 + \dots \quad [|x| < \pi/2]$

Inverse trigonometric series

9. $\arcsin x = x + \frac{x^3}{2.3} + \frac{1.3}{2.4.5}x^5 + \frac{1.3.5}{2.4.6.7}x^7 + \dots \quad [|x| < 1, -\pi/2 < \arcsin x < \pi/2]$
10. $\arccos x = \frac{\pi}{2} - \arcsin x \quad [|x| < 1, 0 < \arccos x < \pi]$
11. $\arctan x = x - \frac{x^3}{3} + \frac{x^5}{5} - \frac{x^7}{7} + \dots \quad [|x| < 1]$
 $= \frac{\pi}{2} - \frac{1}{x} + \frac{1}{3x^3} - \frac{1}{5x^5} + \frac{1}{7x^7} - \dots \quad [x > 1]$
 $= -\frac{\pi}{2} - \frac{1}{x} + \frac{1}{3x^3} - \frac{1}{5x^5} + \frac{1}{7x^7} - \dots \quad [x < -1]$

Exponential series

12. $e^x = 1 + x + \frac{x^2}{2!} + \frac{x^3}{3!} + \frac{x^4}{4!} + \dots \quad [|x| < \infty]$
13. $e^{-x} = 1 - x + \frac{x^2}{2!} - \frac{x^3}{3!} + \frac{x^4}{4!} - \dots \quad [|x| < \infty]$

Logarithmic series

14. $\ln(1+x) = x - \frac{x^2}{2} + \frac{x^3}{3} - \frac{x^4}{4} + \frac{x^5}{5} - \dots \quad [-1 < x \leq 1]$
15. $\ln(1-x) = -\left(x + \frac{x^2}{2} + \frac{x^3}{3} + \frac{x^4}{4}\right) + \dots \quad [-1 \leq x < 1]$
16. $\ln\left(\frac{1+x}{1-x}\right) = 2\left(x + \frac{x^3}{3} + \frac{x^5}{5} + \frac{x^7}{7} + \dots\right) = 2 \operatorname{arctanh} x \quad [|x| < 1]$

$$17. \ln\left(\frac{1-x}{1+x}\right) = -2\left(x + \frac{x^3}{3} + \frac{x^5}{5} + \frac{x^7}{7} + \dots\right) = -2 \operatorname{arctanh} x \quad [|x| < 1]$$

Hyperbolic series

$$18. \sinh x = x + \frac{x^3}{3!} + \frac{x^5}{5!} + \frac{x^7}{7!} + \dots \quad [|x| < \infty]$$

$$19. \cosh x = 1 + \frac{x^2}{2!} + \frac{x^4}{4!} + \frac{x^6}{6!} + \dots \quad [|x| < \infty]$$

$$20. \tanh x = x - \frac{x^3}{3} + \frac{2}{15}x^5 - \frac{17}{315}x^7 + \frac{62}{2835}x^9 - \dots \quad [|x| < \pi/2]$$

Inverse hyperbolic series

$$21. \operatorname{arcsinh} x = x - \frac{1}{2 \cdot 3}x^3 + \frac{1 \cdot 3}{2 \cdot 4 \cdot 5}x^5 - \frac{1 \cdot 3 \cdot 5}{2 \cdot 4 \cdot 6 \cdot 7}x^7 + \dots \quad [|x| < 1]$$

$$22. \operatorname{arccosh} x = \pm \left(\ln(2x) - \frac{1}{2 \cdot 2x^2} - \frac{1 \cdot 3}{2 \cdot 4 \cdot 4x^4} - \frac{1 \cdot 3 \cdot 5}{2 \cdot 4 \cdot 6 \cdot 6x^6} - \dots \right) \quad [x > 1]$$

$$23. \operatorname{arctanh} x = x + \frac{x^3}{3} + \frac{x^5}{5} + \frac{x^7}{7} + \dots \quad [|x| < 1]$$

0.8 GEOMETRY

Triangle

$$\text{Area } A = \frac{1}{2}ah = \frac{1}{2}ac \sin \theta.$$

For the equilateral triangle in which $a = b = c$,

$$A = \frac{a^2\sqrt{3}}{4}, \quad h = \frac{a\sqrt{3}}{2}.$$

The centroid C is located on the median RM (the line drawn from R to the midpoint M of PQ) with $MC = \frac{1}{3}RM$.

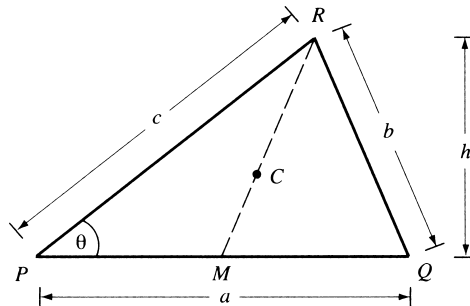

Parallelogram

$$\text{Area } A = ah = ab \sin \alpha.$$

The centroid C is located at the point of intersection of the diagonals.

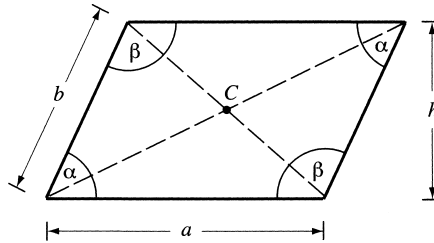

Trapezium A quadrilateral with two sides parallel, where h is the perpendicular distance between the parallel sides.

$$\text{Area } A = \frac{1}{2} (a + b) h.$$

The centroid C is located on PQ , the line joining the midpoints of AB and CD , with

$$QC = \frac{h (a + 2b)}{3 (a + b)}.$$

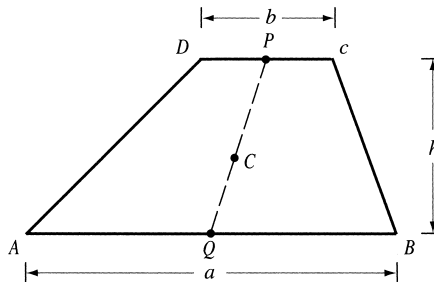

Rhombus A parallelogram with all sides of equal length.

$$\text{Area } A = a^2 \sin \alpha.$$

The centroid C is located at the point of intersection of the diagonals.

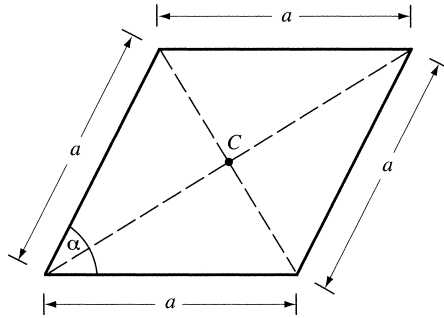

Cube

$$\text{Area } A = 6a^2.$$

$$\text{Volume } V = a^3.$$

$$\text{Diagonal } d = a\sqrt{3}.$$

The centroid C is located at the midpoint of a diagonal.

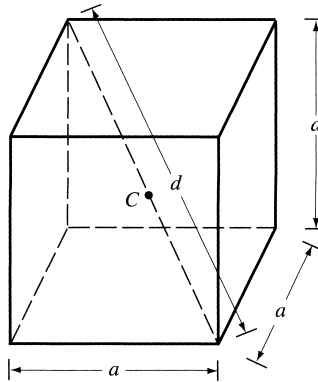

Rectangular parallelepiped

$$\text{Area } A = 2(ab + ac + bc).$$

$$\text{Volume } V = abc.$$

$$\text{Diagonal } d = \sqrt{a^2 + b^2 + c^2}.$$

The centroid C is located at the midpoint of a diagonal.

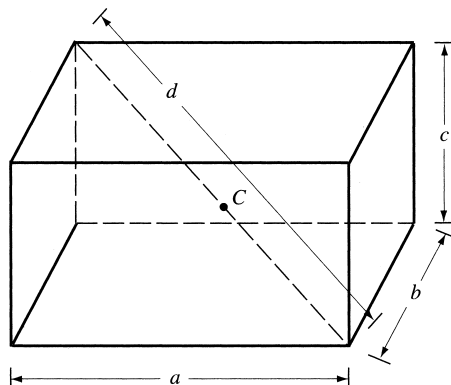

Pyramid Rectangular base with sides of length a and b and four sides comprising pairs of identical isosceles triangles.

$$\text{Area of sides } A_S = a\sqrt{h^2 + (b/2)^2} + b\sqrt{h^2 + (a/2)^2}.$$

$$\text{Area of base } A_B = ab.$$

$$\text{Total area } A = A_B + A_S.$$

$$\text{Volume } V = \frac{1}{3}abh.$$

The centroid C is located on the axis of symmetry with $OC = h/4$.

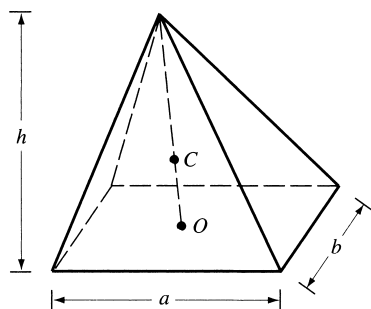

Rectangular (right) wedge Base is rectangular, ends are isosceles triangles of equal size, and the remaining two sides are trapezia.

$$\text{Area of sides } A_S = \frac{1}{2}(a+c)\sqrt{4h^2+b^2} + \frac{1}{2}b\sqrt{4h^2+4(a-c)^2}.$$

$$\text{Area of base } A_B = ab.$$

$$\text{Total area } A = A_B + A_S.$$

$$\text{Volume } V = \frac{bh}{6}(2a+c).$$

The centroid C is located on the axis of symmetry with

$$OC = \frac{h}{2} \frac{(a+c)}{(2a+c)}.$$

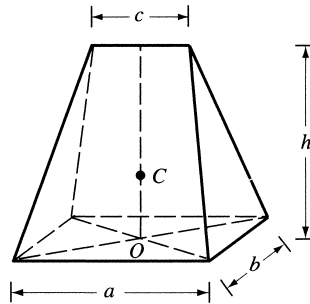

Tetrahedron Formed by four equilateral triangles.

$$\text{Surface area } A = a^2\sqrt{3}.$$

$$\text{Volume } V = \frac{a^3\sqrt{2}}{12}.$$

The centroid C is located on the line from the centroid O of the base triangle to the vertex, with $OC = h/4$.

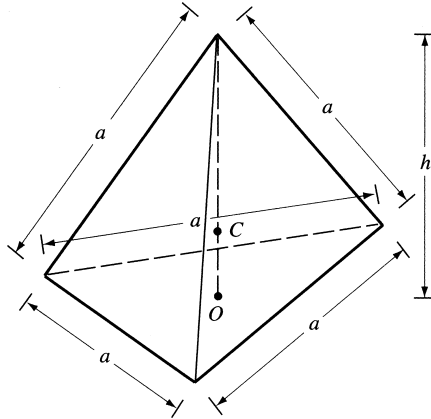

Oblique prism with plane end faces If A_B is the area of a plane end face and h is the perpendicular distance between the parallel end faces, then

$$\text{Total area} = \text{Area of plane sides} + 2A_B.$$

$$\text{Volume } V = A_B h.$$

The centroid C is located at the midpoint of the line C_1C_2 joining the centroid of the parallel end faces.

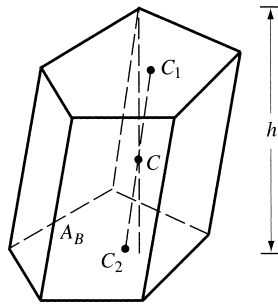

Circle

$$\text{Area } A = \pi r^2, \quad \text{Circumference } L = 2\pi r,$$

where r is the radius of the circle. The centroid is located at the center of the circle.

Arc of circle

$$\text{Length of arc } AB : s = r\alpha \text{ (}\alpha \text{ radians).}$$

The centroid C is located on the axis of symmetry with $OC = ra/s$.

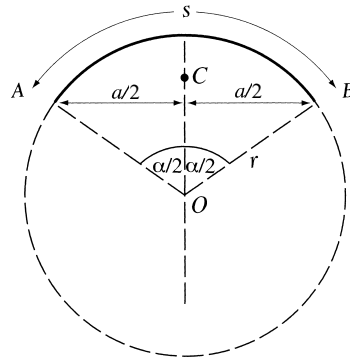

Sector of circle

$$\text{Area } A = \frac{sr}{2} = \frac{r^2\alpha}{2} \text{ } (\alpha \text{ radians}).$$

The centroid C is located on the axis of symmetry with

$$OC = \frac{2}{3} \frac{ra}{s}.$$

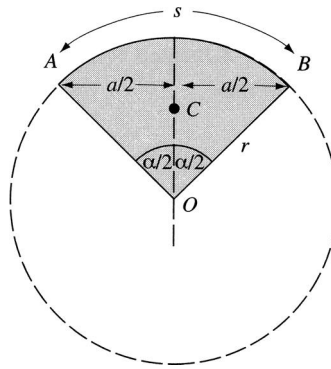

Segment of circle

$$a = 2\sqrt{2hr - h^2}.$$

$$h = r - \frac{1}{2}\sqrt{4r^2 - a^2} \quad [h < r].$$

$$\text{Area } A = \frac{1}{2} [sr - a(r - h)].$$

The centroid C is located on the axis of symmetry with

$$OC = \frac{a^3}{12A}.$$

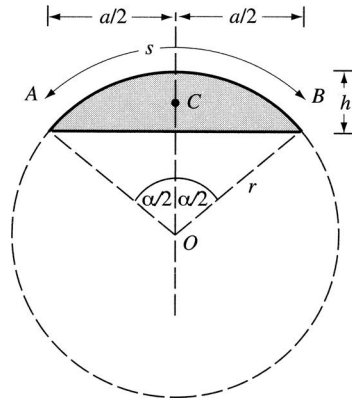

Annulus

$$\text{Area } A = \pi(R^2 - r^2) \quad [r < R].$$

The centroid C is located at the center.

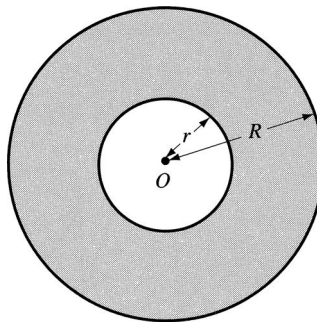

Right circular cylinder

$$\text{Area of curved surface } A_S = 2\pi r h.$$

$$\text{Area of plane ends } A_B = 2\pi r^2.$$

$$\text{Total Area } A = A_B + A_S.$$

$$\text{Volume } V = \pi r^2 h.$$

The centroid C is located on the axis of symmetry with $OC = h/2$.

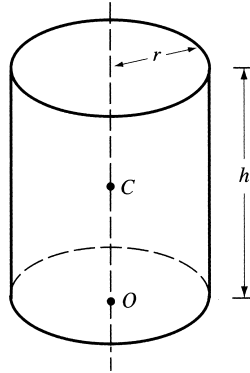

Right circular cylinder with an oblique plane face Here, h_1 is the greatest height of a side of the cylinder, h_2 is the shortest height of a side of the cylinder, and r is the radius of the cylinder.

$$\text{Area of curved surface } A_S = \pi r(h_1 + h_2).$$

$$\text{Area of plane end faces } A_B = \pi r^2 + \pi r \sqrt{r^2 + \left(\frac{h_1 - h_2}{2}\right)^2}.$$

$$\text{Total area } A = \pi r \left[h_1 + h_2 + r + \sqrt{r^2 + \frac{(h_1 - h_2)^2}{2}} \right].$$

$$\text{Volume } V = \frac{\pi r^2}{2} (h_1 + h_2).$$

The centroid C is located on the axis of symmetry with

$$OC = \frac{(h_1 + h_2)}{4} + \frac{1}{16} \frac{(h_1 - h_2)^2}{(h_1 + h_2)}.$$

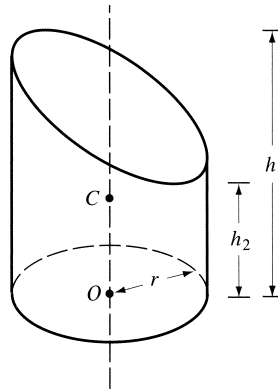

Cylindrical wedge Here, r is radius of cylinder, h is height of wedge, $2a$ is base chord of wedge, b is the greatest perpendicular distance from the base chord to the wall of the cylinder measured perpendicular to the axis of the cylinder, and α is the angle subtended at the center O of the normal cross-section by the base chord.

$$\text{Area of curved surface } A_S = \frac{2rh}{b} \left[(b-r) \frac{\alpha}{2} + a \right].$$

$$\text{Volume } V = \frac{h}{3b} \left[a(3r^2 - a^2) + 3r^2(b-r) \frac{\alpha}{2} \right].$$

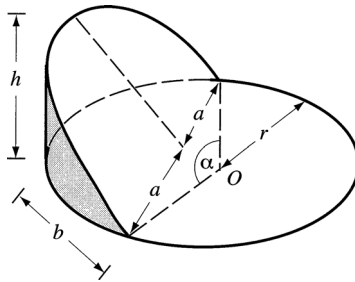

Right circular cone

$$\text{Area of curved surface } A_S = \pi r s.$$

$$\text{Area of plane end } A_B = \pi r^2.$$

$$\text{Total area } A = A_B + A_S.$$

$$\text{Volume } V = \frac{1}{3} \pi r^2 h.$$

The centroid C is located on the axis of symmetry with $OC = h/4$.

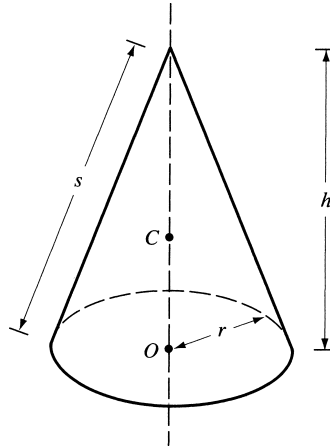

Frustrum of a right circular cone

$$s = \sqrt{h^2 + (r_1 - r_2)^2}.$$

$$\text{Area of curved surface } A_S = \pi s(r_1 + r_2).$$

$$\text{Area of plane ends } A_B = \pi(r_1^2 + r_2^2).$$

$$\text{Total area } A = A_B + A_S.$$

$$\text{Volume } V = \frac{1}{3}\pi h(r_1^2 + r_1 r_2 + r_2^2).$$

The centroid C is located on the axis of symmetry with

$$OC = \frac{h}{4} \frac{(r_1^2 + 2r_1 r_2 + 3r_2^2)}{(r_1^2 + r_1 r_2 + r_2^2)}.$$

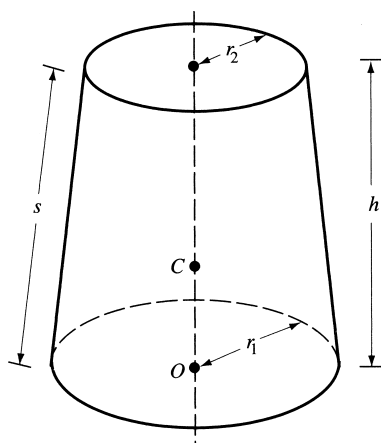

General cone If A is a area of the base and h is the perpendicular height, then Volume $V = \frac{1}{3}Ah$.

The centroid C is located on the line joining the centroid O of the base to the vertex P with

$$OC = \frac{1}{4}OP.$$

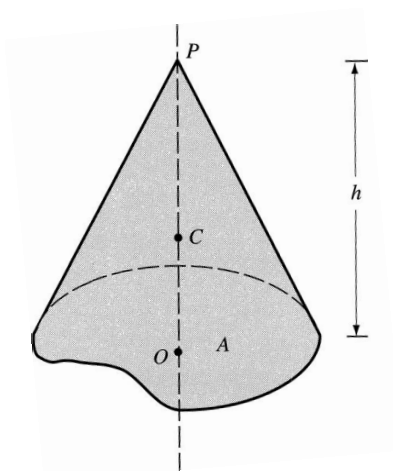

Sphere

Area $A = 4\pi r^2$ (r is radius of sphere).

Volume $V = \frac{4}{3}\pi r^3$.

The centroid is located at the center.

Spherical sector Here, h is height of spherical segment cap, a is radius of plane face of spherical segment cap, and r is radius of sphere. For the area of the spherical cap and conical sides,

$$A = \pi r(2h + a).$$

$$\text{Volume } V = \frac{2\pi r^2 h}{3}.$$

The centroid C is located on the axis of symmetry with $OC = \frac{3}{8}(2r - h)$.

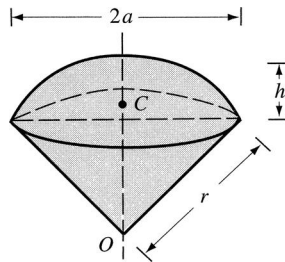

Spherical segment Here, h is height of spherical segment, a is radius of plane face of spherical segment, r is radius of sphere, and $a = \sqrt{h(2r - h)}$.

Area of spherical surface $A_S = 2\pi r h$.

Area of plane face $A_B = \pi a^2$.

Total area $A = A_B + A_S$.

$$\text{Volume } V = \frac{1}{3}\pi h^2(3r - h) = \frac{1}{6}\pi h(3a^2 + h^2).$$

The centroid C is located on the axis of symmetry with $OC = \frac{3}{4} \frac{(2r - h)^2}{(3r - h)}$.

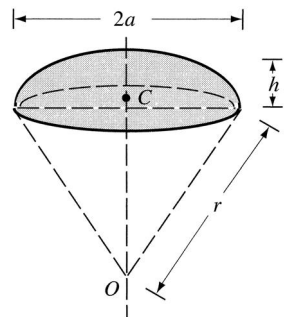

Spherical segment with two parallel plane faces Here, a_1 and a_2 are the radii of the plane faces and h is height of segment.

$$\text{Area of spherical surface } A_S = 2\pi rh.$$

$$\text{Area of plane end faces } A_B = \pi(a_1^2 + a_2^2).$$

$$\text{Total area } A = A_B + A_S.$$

$$\text{Volume } V = \frac{1}{6}\pi h(3a_1^2 + 3a_2^2 + h^2).$$

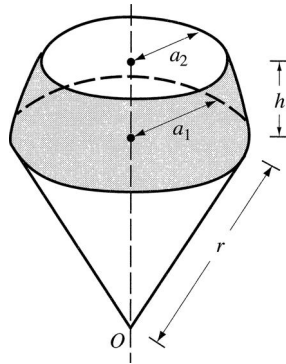

Ellipsoids of revolution Let the ellipse have the equation

$$\frac{x^2}{a^2} + \frac{y^2}{b^2} = 1.$$

When rotated about the x -axis the volume is

$$V_x = \frac{4}{3}\pi ab^2.$$

When rotated about the y -axis the volume is

$$V_y = \frac{4}{3}\pi a^2 b.$$

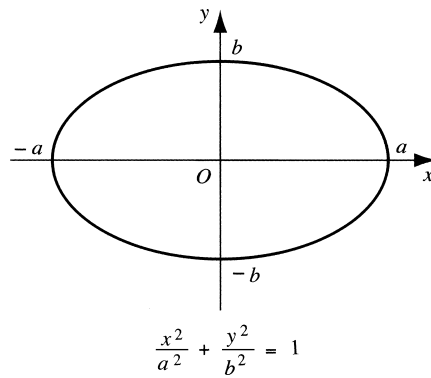

Torus Ring with circular cross-section:

$$\text{Area } A = 4\pi^2 rR.$$

$$\text{Volume } V = 2\pi^2 r^2 R.$$

(See Pappus's theorem 1.15.6.1.5.)

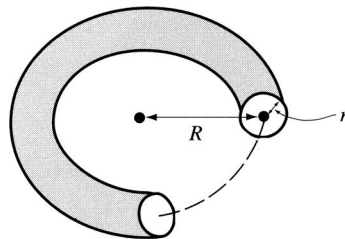

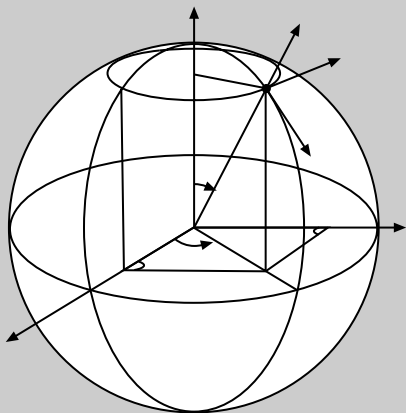

Chapter 1

Numerical, Algebraic, and Analytical Results for Series and Calculus

1.1 ALGEBRAIC RESULTS INVOLVING REAL AND COMPLEX NUMBERS

1.1.1 Complex Numbers

1.1.1.1 Basic Definitions

If a, b, c, d, \dots are real numbers, the set \mathbb{C} of complex numbers, in which individual complex numbers are denoted by z, ζ, ω, \dots , is the set of all ordered number pairs $(a, b), (c, d), \dots$ that obey the following rules defining the equality, sum, and product of complex numbers.

If $z_1 = (a, b)$ and $z_2 = (c, d)$, then:

$$(Equality) \quad z_1 = z_2 \text{ implies, } a = c \text{ and } b = d,$$

$$(Sum) \quad z_1 + z_2 \text{ implies, } (a + c, b + d),$$

$$(Product) \quad z_1 z_2 \text{ or } z_1 \cdot z_2 \text{ implies, } (ac - bd, ad + bc).$$

Because $(a, 0) + (b, 0) = (a + b, 0)$ and $(a, 0) \cdot (b, 0) = (ab, 0)$ it is usual to set the complex number $(x, 0) = x$ and to call it a **purely real** number, since it has the properties of a real number. The complex number $i = (0, 1)$ is called **imaginary unit**, and from the definition of multiplication $(0, 1) \cdot (0, 1) = (-1, 0)$, so it follows that

$$i^2 = -1 \quad \text{or} \quad i = \sqrt{-1}.$$

If $z = (x, y)$, the **real part** of z , denoted by $\text{Re}\{z\}$, is defined as $\text{Re}\{z\} = x$, while the **imaginary part** of z , denoted by $\text{Im}\{z\}$, is defined as $\text{Im}\{z\} = y$. A number of the form

$(0, y) = (y, 0) \cdot (0, 1) = yi$ is called a **purely imaginary** number. The **zero** complex number $z = (0, 0)$ is also written $z = 0$. The **complex conjugate** \bar{z} of a complex number $z = (x, y)$ is defined as

$$\bar{z} = (x, -y),$$

while its **modulus** (also called its **absolute value**) is the real number $|z|$ defined as

$$|z| = (x^2 + y^2)^{1/2},$$

so that

$$|z|^2 = z\bar{z}.$$

The **quotient** of the two complex numbers z_1 and z_2 is given by

$$\frac{z_1}{z_2} = \frac{z_1\bar{z}_2}{z_2\bar{z}_2} = \frac{z_1\bar{z}_2}{|z_2|^2} \quad [z_2 \neq 0].$$

When working with complex numbers it is often more convenient to replace the ordered pair notation $z = (x, y)$ by the equivalent notation $z = x + iy$.

1.1.1.2 Properties of the Modulus and Complex Conjugate

1. If $z = (x, y)$ then

$$\begin{aligned} z + \bar{z} &= 2 \operatorname{Re}\{z\} = 2x \\ z - \bar{z} &= 2i \operatorname{Im}\{z\} = 2iy \end{aligned}$$

2. $|z| = |\bar{z}|$

3. $z = \overline{(\bar{z})}$

4. $\frac{1}{\bar{z}} = \overline{\left(\frac{1}{z}\right)}$ $[z \neq 0]$

5. $\overline{(z^n)} = (\bar{z})^n$

6. $\left|\frac{\bar{z}_1}{\bar{z}_2}\right| = \frac{|\bar{z}_1|}{|\bar{z}_2|}$ $[z_2 \neq 0]$

7. $\overline{(z_1 + z_2 + \cdots + z_n)} = \bar{z}_1 + \bar{z}_2 + \cdots + \bar{z}_n$

8. $\overline{z_1 z_2 \cdots z_n} = \bar{z}_1 \bar{z}_2 \cdots \bar{z}_n$

1.1.2 Algebraic Inequalities Involving Real and Complex Numbers

1.1.2.1 The Triangle and a Related Inequality

If a, b are any two real numbers, then

$$\begin{aligned} |a + b| &\leq |a| + |b| && \text{(triangle inequality)} \\ |a - b| &\geq ||a| - |b||, \end{aligned}$$

where $|a|$, the absolute value of a is defined as

$$|a| = \begin{cases} a, & a \geq 0 \\ -a, & a < 0. \end{cases}$$

Analogously, if a, b are any two complex numbers, then

$$\begin{aligned} |a + b| &\leq |a| + |b| && \text{(triangle inequality)} \\ |a - b| &\geq ||a| - |b||. \end{aligned}$$

1.1.2.2 Lagrange's Identity

Let a_1, a_2, \dots, a_n and b_1, b_2, \dots, b_n be any two sets of real numbers; then

$$\left(\sum_{k=1}^n a_k b_k \right)^2 = \left(\sum_{k=1}^n a_k^2 \right) \left(\sum_{k=1}^n b_k^2 \right) - \sum_{1 \leq k < j \leq n} (a_k b_j - a_j b_k)^2.$$

1.1.2.3 Cauchy–Schwarz–Buniakowsky Inequality

Let a_1, a_2, \dots, a_n and b_1, b_2, \dots, b_n be any two arbitrary sets of real numbers; then

$$\left(\sum_{k=1}^n a_k b_k \right)^2 \leq \left(\sum_{k=1}^n a_k^2 \right) \left(\sum_{k=1}^n b_k^2 \right).$$

The equality holds if, and only if, the sequences a_1, a_2, \dots, a_n and b_1, b_2, \dots, b_n are proportional. Analogously, let a_1, a_2, \dots, a_n and b_1, b_2, \dots, b_n be any two arbitrary sets of complex numbers; then

$$\left| \sum_{k=1}^n a_k b_k \right|^2 \leq \left(\sum_{k=1}^n |a_k|^2 \right) \left(\sum_{k=1}^n |b_k|^2 \right).$$

The equality holds if, and only if, the sequences $\bar{a}_1, \bar{a}_2, \dots, \bar{a}_n$ and b_1, b_2, \dots, b_n are proportional.

1.1.2.4 Minkowski's Inequality

Let a_1, a_2, \dots, a_n and b_1, b_2, \dots, b_n be any two sets of nonnegative real numbers and let $p > 1$; then

$$\left(\sum_{k=1}^n (a_k + b_k)^p \right)^{1/p} \leq \left(\sum_{k=1}^n a_k^p \right)^{1/p} + \left(\sum_{k=1}^n b_k^p \right)^{1/p}.$$

The equality holds if, and only if, the sequences a_1, a_2, \dots, a_n and b_1, b_2, \dots, b_n are proportional. Analogously, let a_1, a_2, \dots, a_n and b_1, b_2, \dots, b_n be any two arbitrary sets of complex

numbers, and let the real number p be such that $p > 1$; then

$$\left(\sum_{k=1}^n |a_k + b_k|^p \right)^{1/p} \leq \left(\sum_{k=1}^n |a_k|^p \right)^{1/p} + \left(\sum_{k=1}^n |b_k|^p \right)^{1/p}.$$

1.1.2.5 Hölder's Inequality

Let a_1, a_2, \dots, a_n and b_1, b_2, \dots, b_n be any two sets of nonnegative real numbers, and let $1/p + 1/q = 1$, with $p > 1$; then

$$\left(\sum_{k=1}^n a_k^p \right)^{1/p} \left(\sum_{k=1}^n b_k^q \right)^{1/q} \geq \sum_{k=1}^n a_k b_k.$$

The equality holds if, and only if, the sequences $a_1^p, a_2^p, \dots, a_n^p$ and $b_1^q, b_2^q, \dots, b_n^q$ are proportional. Analogously, let a_1, a_2, \dots, a_n and b_1, b_2, \dots, b_n be any two arbitrary sets of complex numbers, and let the real number p, q be such that $p > 1$ and $1/p + 1/q = 1$; then

$$\left(\sum_{k=1}^n |a_k|^p \right)^{1/p} \left(\sum_{k=1}^n |b_k|^q \right)^{1/q} \geq \left| \sum_{k=1}^n a_k b_k \right|.$$

1.1.2.6 Chebyshev's Inequality

Let a_1, a_2, \dots, a_n and b_1, b_2, \dots, b_n be two arbitrary sets of real numbers such that either $a_1 \geq a_2 \geq \dots \geq a_n$ and $b_1 \geq b_2 \geq \dots \geq b_n$, or $a_1 \leq a_2 \leq \dots \leq a_n$ and $b_1 \leq b_2 \leq \dots \leq b_n$; then

$$\left(\frac{a_1 + a_2 + \dots + a_n}{n} \right) \left(\frac{b_1 + b_2 + \dots + b_n}{n} \right) \leq \frac{1}{n} \sum_{k=1}^n a_k b_k.$$

The equality holds if, and only if, either $a_1 = a_2 = \dots = a_n$ or $b_1 = b_2 = \dots = b_n$.

1.1.2.7 Arithmetic–Geometric Inequality

Let a_1, a_2, \dots, a_n be any set of positive numbers with arithmetic mean

$$A_n = \left(\frac{a_1 + a_2 + \dots + a_n}{n} \right)$$

and geometric mean

$$G_n = (a_1 a_2 \cdots a_n)^{1/n};$$

then $A_n \geq G_n$ or, equivalently,

$$\left(\frac{a_1 + a_2 + \dots + a_n}{n} \right) \geq (a_1 a_2 \cdots a_n)^{1/n}.$$

The equality holds only when $a_1 = a_2 = \dots = a_n$.

1.1.2.8 Carleman's Inequality

If a_1, a_2, \dots, a_n is any set of positive numbers, then the geometric and arithmetic means satisfy the inequality

$$\sum_{k=1}^n G_k \leq eA_n$$

or, equivalently,

$$\sum_{k=1}^n (a_1 a_2 \cdots a_k)^{1/k} \leq e \left(\frac{a_1 + a_2 + \cdots + a_n}{n} \right),$$

where e is the best possible constant in this inequality.

The next inequality to be listed is of a somewhat different nature than that of the previous ones in that it involves a function of the type known as *convex*. When interpreted geometrically, a function $f(x)$ that is convex on an interval $I = [a, b]$ is one for which all points on the graph of $y = f(x)$ for $a < x < b$ lie below the chord joining the points $(a, f(a))$ and $(b, f(b))$.

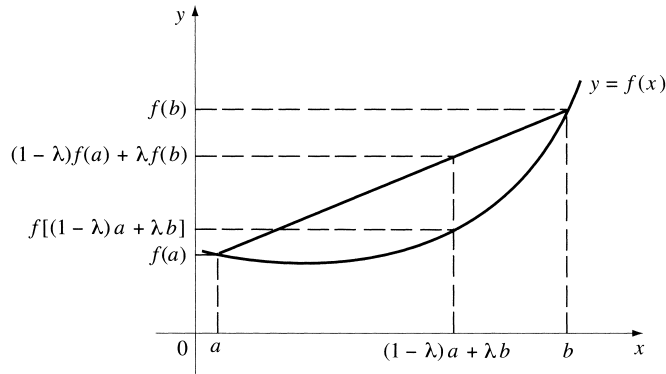

Definition of convexity. A function $f(x)$ defined on some interval $I = [a, b]$ is said to be **convex** on I if, and only if,

$$f[(1 - \lambda)a + \lambda b] \leq (1 - \lambda)f(a) + \lambda f(b),$$

for $a \neq b$ and $0 < \lambda < 1$.

The function is said to be **strictly convex** on I if the preceding inequality is strict, so that

$$f[(1 - \lambda)a + \lambda b] < (1 - \lambda)f(a) + \lambda f(b).$$

1.1.2.9 Jensen's Inequality

Let $f(x)$ be convex on the interval $I = [a, b]$, let x_1, x_2, \dots, x_n be points in I , and take $\lambda_1, \lambda_2, \dots, \lambda_n$ to be nonnegative numbers such that

$$\lambda_1 + \lambda_2 + \cdots + \lambda_n = 1.$$

Then the point $\lambda_1 x_1 + \lambda_2 x_2 + \cdots + \lambda_n x_n$ lies in I and

$$f(\lambda_1 x_1 + \lambda_2 x_2 + \cdots + \lambda_n x_n) \leq \lambda_1 f(x_1) + \lambda_2 f(x_2) + \cdots + \lambda_n f(x_n).$$

If all the λ_i 's are strictly positive and $f(x)$ is strictly convex on I , then the equality holds if, and only if,

$$x_1 = x_2 = \cdots = x_n.$$

1.2 FINITE SUMS

1.2.1 The Binomial Theorem for Positive Integral Exponents

1.2.1.1 Binomial Theorem and Binomial Coefficients

If a, b are real or complex numbers, the **binomial theorem** for positive integral exponents n is

$$(a + b)^n = \sum_{k=0}^n \binom{n}{k} a^k b^{n-k} \quad [n = 1, 2, 3, \dots],$$

with

$$\binom{n}{0} = 1, \quad \binom{n}{k} = \frac{n!}{k!(n-k)!} \quad [k = 0, 1, 2, \dots, \leq n],$$

and $k! = 1 \cdot 2 \cdot 3 \cdot \cdots \cdot k$ and, by definition $0! = 1$. The numbers $\binom{n}{k}$ are called **binomial coefficients**.

When expanded, the binomial theorem becomes

$$\begin{aligned} (a + b)^n &= a^n + na^{n-1}b + \frac{n(n-1)}{2!}a^{n-2}b^2 + \frac{n(n-1)(n-2)}{3!}a^{n-3}b^3 + \cdots \\ &\quad + \frac{n(n-1)}{2!}a^2b^{n-2} + nab^{n-1} + b^n. \end{aligned}$$

An alternative form of the binomial theorem is

$$(a + b)^n = a^n \left(1 + \frac{b}{a}\right)^n = a^n \sum_{k=0}^n \binom{n}{k} \left(\frac{b}{a}\right)^{n-k} \quad [n = 1, 2, 3, \dots].$$

If n is a positive integer, the binomial expansion of $(a + b)^n$ contains $n + 1$ terms, and so is a **finite sum**. However, if n is *not* a positive integer (it may be a positive or negative real number) the binomial expansion becomes an infinite series (see 0.7.5). (For a connection with probability see 1.6.1.1.4.)

1.2.1.2 Short Table of Binomial Coefficients $\binom{n}{k}$

	k												
n	0	1	2	3	4	5	6	7	8	9	10	11	12
1	1	1											
2	1	2	1										
3	1	3	3	1									
4	1	4	6	4	1								
5	1	5	10	10	5	1							
6	1	6	15	20	15	6	1						
7	1	7	21	35	35	21	7	1					
8	1	8	28	56	70	56	28	8	1				
9	1	9	36	84	126	126	84	36	9	1			
10	1	10	45	120	210	252	210	120	45	10	1		
11	1	11	55	165	330	462	462	330	165	55	11	1	
12	1	12	66	220	495	792	924	792	495	220	66	12	1

Reference to the first four rows of the table shows that

$$(a + b)^1 = a + b$$

$$(a + b)^2 = a^2 + 2ab + b^2$$

$$(a + b)^3 = a^3 + 3a^2b + 3ab^2 + b^3$$

$$(a + b)^4 = a^4 + 4a^3b + 6a^2b^2 + 4ab^3 + b^4.$$

The binomial coefficients $\binom{n}{k}$ can be generated in a simple manner by means of the following triangular array called **Pascal's triangle**.

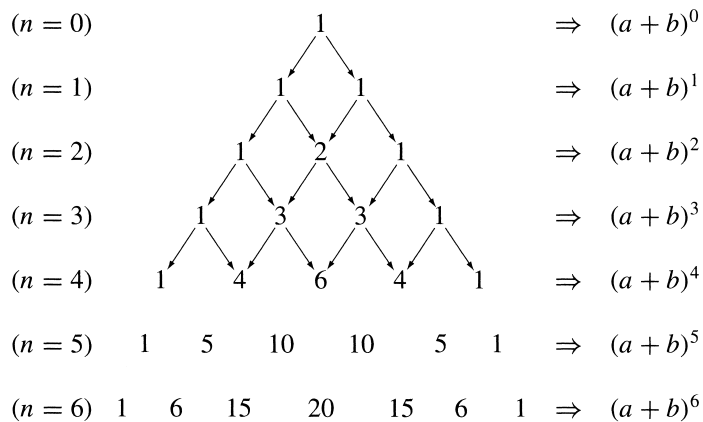

The entries in the n th row are the binomial coefficients $\binom{n}{k}$ ($k = 0, 1, 2, \dots, n$). Each entry inside the triangle is obtained by summing the entries to its immediate left and right in the row above, as indicated by the arrows.

1.2.1.3 Relationships Between Binomial Coefficients

1. $\binom{n}{k} = \frac{n!}{k!(n-k)!} = \frac{n(n-1)(n-2) \cdots (n-k+1)}{k!} = \frac{n+1-k}{k} \binom{n}{k-1}$
2. $\binom{n}{0} = 1$, $\binom{n}{1} = n$, $\binom{n}{k} = \binom{n}{n-k}$, $\binom{n}{n} = 1$
3. $\binom{n}{k+1} = \frac{n-k}{k+1} \binom{n}{k}$, $\binom{n+1}{k} = \binom{n}{k} + \binom{n}{k-1}$, $\binom{n+1}{k+1} = \binom{n}{k} + \binom{n}{k+1}$
4. $\binom{2n}{n} = \frac{(2n)!}{(n!)^2}$, $\binom{2n-1}{n} = \frac{n(2n-1)!}{(n!)^2}$
5. $\binom{-n}{k} = \frac{(-n)(-n-1)(-n-2) \cdots (-n-k+1)}{k!} = (-1)^k \binom{n+k-1}{k}$

1.2.1.4 Sums of Binomial Coefficients (n is an integer)

1. $\binom{n}{0} - \binom{n}{1} + \binom{n}{2} - \cdots + (-1)^m \binom{n}{m} = (-1)^m \binom{n-1}{m}$
 $[n \geq 1, m = 0, 1, 2, \dots, n-1]$
2. $\binom{n}{0} - \binom{n}{1} + \binom{n}{2} - \cdots + (-1)^n \binom{n}{n} = 0$
 $\left[\text{from 1.2.1.4.1 with } m = n-1, \text{ because } \binom{n-1}{n-1} = 1 \right]$
3. $\binom{n}{k} + \binom{n-1}{k} + \binom{n-2}{k} + \cdots + \binom{k}{k} = \binom{n+1}{k+1}$
4. $\binom{n}{0} + \binom{n}{1} + \binom{n}{2} + \cdots + \binom{n}{n} = 2^n$
5. $\binom{n}{0} + \binom{n}{2} + \binom{n}{4} + \cdots + \binom{n}{m} = 2^{n-1}$ [$m = n$ (even n), $m = n-1$ (odd n)]
6. $\binom{n}{1} + \binom{n}{3} + \binom{n}{5} + \cdots + \binom{n}{m} = 2^{n-1}$ [$m = n$ (even n), $m = n-1$ (odd n)]

$$7. \binom{n}{0} + \binom{n}{3} + \binom{n}{6} + \cdots + \binom{n}{m} = \frac{1}{3} \left(2^n + 2 \cos \frac{n\pi}{3} \right)$$

$[m = n \text{ (even } n), m = n - 1 \text{ (odd } n)]$

$$8. \binom{n}{1} + \binom{n}{4} + \binom{n}{7} + \cdots + \binom{n}{m} = \frac{1}{3} \left(2^n + 2 \cos \frac{(n-2)\pi}{3} \right)$$

$[m = n \text{ (even } n), m = n - 1 \text{ (odd } n)]$

$$9. \binom{n}{2} + \binom{n}{5} + \binom{n}{8} + \cdots + \binom{n}{m} = \frac{1}{3} \left(2^n + 2 \cos \frac{(n-4)\pi}{3} \right)$$

$[m = n \text{ (even } n), m = n - 1 \text{ (odd } n)]$

$$10. \binom{n}{0} + \binom{n}{4} + \binom{n}{8} + \cdots + \binom{n}{m} = \frac{1}{2} \left(2^{n-1} + 2^{n/2} \cos \frac{n\pi}{4} \right)$$

$[m = n \text{ (even } n), m = n - 1 \text{ (odd } n)]$

$$11. \binom{n}{1} + \binom{n}{5} + \binom{n}{9} + \cdots + \binom{n}{m} = \frac{1}{2} \left(2^{n-1} + 2^{n/2} \sin \frac{n\pi}{4} \right)$$

$[m = n \text{ (even } n), m = n - 1 \text{ (odd } n)]$

$$12. \binom{n}{2} + \binom{n}{6} + \binom{n}{10} + \cdots + \binom{n}{m} = \frac{1}{2} \left(2^{n-1} - 2^{n/2} \cos \frac{n\pi}{4} \right)$$

$[m = n \text{ (even } n), m = n - 1 \text{ (odd } n)]$

$$13. \binom{n}{3} + \binom{n}{7} + \binom{n}{11} + \cdots + \binom{n}{n} = \frac{1}{2} \left(2^{n-1} - 2^{n/2} \sin \frac{n\pi}{4} \right)$$

$$14. \binom{n}{0} + 2\binom{n}{1} + 3\binom{n}{2} + \cdots + (n+1)\binom{n}{n} = 2^{n-1}(n+2) \quad [n \geq 0]$$

$$15. \binom{n}{1} - 2\binom{n}{2} + 3\binom{n}{3} - \cdots + (-1)^{n+1} n \binom{n}{n} = 0 \quad [n \geq 2]$$

$$16. \binom{N}{1} - 2^{n-1}\binom{N}{2} + 3^{n-1}\binom{N}{3} - \cdots + (-1)^N N^{n-1} \binom{N}{N} = 0 \quad [N \geq n; 0^0 \equiv 1]$$

$$17. \binom{n}{1} - 2^n \binom{n}{2} + 3^n \binom{n}{3} - \cdots + (-1)^{n+1} n^n \binom{n}{n} = (-1)^{n+1} n!$$

$$18. \binom{n}{0} + \frac{1}{2}\binom{n}{1} + \frac{1}{3}\binom{n}{2} + \cdots + \frac{1}{n+1}\binom{n}{n} = \frac{2^{n+1} - 1}{n+1}$$

$$19. \binom{n}{0}^2 + \binom{n}{1}^2 + \binom{n}{2}^2 + \cdots + \binom{n}{n}^2 = \binom{2n}{n}$$

$$20. \binom{n}{1} - \frac{1}{2} \binom{n}{2} + \frac{1}{3} \binom{n}{3} - \cdots + \frac{(-1)^{n+1}}{n} \binom{n}{n} = 1 + \frac{1}{2} + \frac{1}{3} + \cdots + \frac{1}{n}$$

1.2.2 Arithmetic, Geometric, and Arithmetic–Geometric Series

1.2.2.1 Arithmetic Series

$$\begin{aligned} \sum_{k=0}^{n-1} (a + kd) &= a + (a + d) + (a + 2d) + \cdots + [a + (n - 1)d] \\ &= \frac{n}{2}[2a + (n - 1)d] = \frac{n}{2}(a + l) \quad [l = \text{the last term}] \end{aligned}$$

1.2.2.2 Geometric Series

$$\begin{aligned} \sum_{k=1}^n ar^{k-1} &= a + ar + ar^2 + \cdots + ar^{n-1} \\ &= \frac{a(1 - r^n)}{1 - r} \quad [r \neq 1] \end{aligned}$$

1.2.2.3 Arithmetic–Geometric Series

$$\begin{aligned} \sum_{k=1}^{n-1} (a + kd)r^k &= a + (a + d)r + (a + 2d)r^2 + \cdots + [a + (n - 1)d]r^{n-1} \\ &= \frac{r^n \{a(r - 1) + [n(r - 1) - r]d\}}{(r - 1)^2} + \frac{[(d - a)r + a]}{(r - 1)^2} \quad [r \neq 1, n > 1] \end{aligned}$$

1.2.3 Sums of Powers of Integers

1.2.3.1

$$1. \sum_{k=1}^n k = 1 + 2 + 3 + \cdots + n = \frac{n}{2}(n + 1)$$

$$2. \sum_{k=1}^n k^2 = 1^2 + 2^2 + 3^2 + \cdots + n^2 = \frac{n}{6}(n + 1)(2n + 1)$$

$$3. \sum_{k=1}^n k^3 = 1^3 + 2^3 + 3^3 + \cdots + n^3 = \frac{n^2}{4}(n + 1)^2$$

$$4. \sum_{k=1}^n k^4 = 1^4 + 2^4 + 3^4 + \cdots + n^4 = \frac{n}{30}(n + 1)(2n + 1)(3n^2 + 3n - 1)$$

$$5. \sum_{k=1}^n k^q = \frac{n^{q+1}}{q+1} + \frac{n^q}{2} + \frac{1}{2} \binom{q}{1} B_2 n^{q-1} + \frac{1}{4} \binom{q}{3} B_4 n^{q-3} \\ + \frac{1}{6} \binom{q}{5} B_6 n^{q-5} + \frac{1}{8} \binom{q}{7} B_8 n^{q-7} + \dots,$$

where $B_2 = 1/6$, $B_4 = -1/30$, $B_6 = 1/42, \dots$, are the Bernoulli numbers (see 1.3.1) and the expansion terminates with the last term containing either n or n^2 .

These results are useful when summing finite series with terms involving linear combinations of powers of integers. For example, using 1.2.3.1.1 and 1.2.3.1.2 leads to the result

$$\begin{aligned} \sum_{k=1}^n (3k-1)(k+2) &= \sum_{k=1}^n (3k^2 + 5k - 2) = 3 \sum_{k=1}^n k^2 + 5 \sum_{k=1}^n k - 2 \sum_{k=1}^n 1 \\ &= 3 \cdot \frac{n}{6} (n+1)(2n+1) + 5 \cdot \frac{n}{2} (n+1) - 2n \\ &= n(n^2 + 4n + 1). \end{aligned}$$

1.2.3.2

1.
$$\begin{aligned} \sum_{k=1}^n (km - 1) &= (m-1) + (2m-1) + (3m-1) + \dots + (nm-1) \\ &= \frac{1}{2} mn(n+1) - n \end{aligned}$$
2.
$$\begin{aligned} \sum_{k=1}^n (km - 1)^2 &= (m-1)^2 + (2m-1)^2 + (3m-1)^2 + \dots + (nm-1)^2 \\ &= \frac{1}{6} n [m^2(n+1)(2n+1) - 6m(n+1) + 6] \end{aligned}$$
3.
$$\begin{aligned} \sum_{k=1}^n (km - 1)^3 &= (m-1)^3 + (2m-1)^3 + (3m-1)^3 + \dots + (nm-1)^3 \\ &= \frac{1}{4} n [m^3 n(n+1)^2 - 2m^2(n+1)(2n+1) + 6m(n+1) - 4] \end{aligned}$$
4.
$$\begin{aligned} \sum_{k=1}^n (-1)^{k+1} (km - 1) &= (m-1) - (2m-1) + (3m-1) - \dots + (-1)^{n+1} (nm-1) \\ &= \frac{(-1)^n}{4} [2 - (2n+1)m] + \frac{(m-2)}{4} \end{aligned}$$
5.
$$\begin{aligned} \sum_{k=1}^n (-1)^{k+1} (km - 1)^2 &= (m-1)^2 - (2m-1)^2 + (3m-1)^2 - \dots + (-1)^{n+1} (nm-1)^2 \\ &= \frac{(-1)^{n+1}}{2} [n(n+1)m^2 - (2n+1)m + 1] + \frac{(1-m)}{2} \end{aligned}$$

6.
$$\begin{aligned}\sum_{k=1}^n (-1)^{k+1} (km - 1)^3 &= (m - 1)^3 - (2m - 1)^3 + (3m - 1)^3 - \cdots + (-1)^{n+1} (nm - 1)^3 \\ &= \frac{(-1)^{n+1}}{8} [(4n^3 + 6n^2 - 1)m^3 - 12n(n + 1)m^2 \\ &\quad + 6(2n + 1)m - 4] - \frac{1}{8}(m^3 - 6m + 4)\end{aligned}$$
7.
$$\begin{aligned}\sum_{k=1}^n (-1)^{k+1} (2k - 1)^2 &= 1^2 - 3^2 + 5^2 - \cdots + (-1)^{n+1} (2n - 1)^2 \\ &= \frac{(-1)^{n+1}}{2} (4n^2 - 1) - \frac{1}{2}\end{aligned}$$
8.
$$\begin{aligned}\sum_{k=1}^n (-1)^{k+1} (2k - 1)^3 &= 1^3 - 3^3 + 5^3 - \cdots + (-1)^{n+1} (2n - 1)^3 \\ &= (-1)^{n+1} n(4n^2 - 3)\end{aligned}$$
9.
$$\begin{aligned}\sum_{k=1}^n (-1)^{k+1} (3k - 1) &= 2 - 5 + 8 - \cdots + (-1)^{n+1} (3n - 1) \\ &= \frac{(-1)^{n+1}}{4} (6n + 1) + \frac{1}{4}\end{aligned}$$
10.
$$\begin{aligned}\sum_{k=1}^n (-1)^{k+1} (3k - 1)^2 &= 2^2 - 5^2 + 8^2 - \cdots + (-1)^{n+1} (3n - 1)^2 \\ &= \frac{(-1)^{n+1}}{2} (9n^2 + 3n - 2) - 1\end{aligned}$$
11.
$$\begin{aligned}\sum_{k=1}^n (-1)^{k+1} (3k - 1)^3 &= 2^3 - 5^3 + 8^3 - \cdots + (-1)^{n+1} (3n - 1)^3 \\ &= \frac{(-1)^{n+1}}{8} (108n^3 + 54n^2 - 72n - 13) - \frac{13}{8}\end{aligned}$$

1.2.4 Proof by Mathematical Induction

Many mathematical propositions that depend on an integer n that are true in general can be proved by means of mathematical induction. Let $P(n)$ be a proposition that depends on an integer n that is believed to be true for all $n > n_0$. To establish the validity of $P(n)$ for $n > n_0$ the following steps are involved.

1. Show, if possible, that $P(n)$ is true for some $n = n_0$.
2. Show, if possible, that when $P(n)$ is true for $n > n_0$, then $P(n)$ implies $P(n + 1)$.

3. If steps 1 and 2 are found to be true, then by mathematical induction $P(n)$ is true for all $n > n_0$.
4. If either of steps 1 or 2 are found to be false then the proposition $P(n)$ is also false.

Examples

1. Prove by mathematical induction that entry 1.2.3.1 (1) is true. Let $P(n)$ be the proposition that

$$\sum_{k=1}^n k = 1 + 2 + 3 + \cdots + n = \frac{1}{2}n(n+1),$$

then clearly $P(1)$ is true so we set $n_0 = 1$. If $P(n)$ is true, adding $(n+1)$ to both sides of the expression gives

$$\begin{aligned} 1 + 2 + \cdots + n + (n+1) &= \frac{1}{2}n(n+1) + (n+1) \\ &= \frac{1}{2}(n+1)(n+2), \end{aligned}$$

but this is simply $P(n)$ with n replaced by $n+1$ so that $P(n)$ implies $P(n+1)$. As $P(n)$ is true for $n = 1$ it follows that $P(n)$ is true for $n = 1, 2, \dots$, and so

$$\sum_{k=1}^n k = 1 + 2 + 3 + \cdots + n = \frac{1}{2}n(n+1) \quad \text{for all } n \geq 1.$$

2. Prove by mathematical induction that

$$\frac{d^n}{dx^n} [\sin ax] = a^n \sin \left(ax + \frac{1}{2}n\pi \right) \quad \text{for } n = 1, 2, \dots$$

Taking the above result to be the proposition $P(n)$ and setting $n = 1$ we find that

$$\frac{d}{dx} [\sin ax] = a \cos ax,$$

showing that $P(1)$ is true, so we set $n_0 = 1$.

Assuming $P(k)$ to be true for $k > 1$, differentiation gives

$$\frac{d}{dx} \left\{ \frac{d^k}{dx^k} [\sin ax] \right\} = \frac{d}{dx} \left\{ a^k \sin \left(ax + \frac{1}{2}k\pi \right) \right\},$$

so

$$\frac{d^{k+1}}{dx^{k+1}} [\sin ax] = a^{k+1} \cos \left(ax + \frac{1}{2}k\pi \right).$$

Replacing k by $k + 1$ in $P(k)$ gives

$$\begin{aligned}\frac{d^{k+1}}{dx^{k+1}}[\sin ax] &= a^{k+1} \sin \left[ax + \frac{1}{2}(k+1)\pi \right] \\ &= a^{k+1} \sin \left[\left(ax + \frac{1}{2}k\pi \right) + \frac{1}{2}\pi \right] \\ &= a^{k+1} \cos \left(ax + \frac{1}{2}k\pi \right),\end{aligned}$$

showing that $P(k)$ implies $P(k+1)$, so as $P(k)$ is true for $k = 1$ it follows that $P(n)$ is true for $n = 1, 2, \dots$

1.3 BERNOULLI AND EULER NUMBERS AND POLYNOMIALS

1.3.1 Bernoulli and Euler Numbers

1.3.1.1 Definitions and Tables of Bernoulli and Euler Numbers

The **Bernoulli numbers**, usually denoted by B_n , are rational numbers defined by the requirement that B_n is the coefficient of the term $t^n/n!$ on the right-hand side of the generating function

$$1. \quad \frac{t}{e^t - 1} = \sum_{n=0}^{\infty} \frac{t^n}{n!} B_n.$$

The B_n are determined by multiplying the above identity in t by the Maclaurin series representation of $e^t - 1$, expanding the right-hand side, and then equating corresponding coefficients of powers of t on either side of the identity. This yields the result

$$\begin{aligned}t &= B_0 t + \left(B_1 + \frac{1}{2} B_0 \right) t^2 + \left(\frac{1}{2} B_2 + \frac{1}{2} B_1 + \frac{1}{6} B_0 \right) t^3 \\ &\quad + \left(\frac{1}{6} B_3 + \frac{1}{4} B_2 + \frac{1}{6} B_1 + \frac{1}{24} B_0 \right) t^4 + \dots\end{aligned}$$

Equating corresponding powers of t leads to the system of equations

$$B_0 = 1 \quad (\text{coefficients of } t)$$

$$B_1 + \frac{1}{2} B_0 = 0 \quad (\text{coefficients of } t^2)$$

$$\frac{1}{2} B_2 + \frac{1}{2} B_1 + \frac{1}{6} B_0 = 0 \quad (\text{coefficients of } t^3)$$

$$\frac{1}{6} B_3 + \frac{1}{4} B_2 + \frac{1}{6} B_1 + \frac{1}{24} B_0 = 0 \quad (\text{coefficients of } t^4)$$

⋮

Solving these equations recursively generates $B_0, B_1, B_2, B_3, \dots$, in this order, where

$$B_0 = 1, \quad B_1 = -\frac{1}{2}, \quad B_2 = \frac{1}{6}, \quad B_3 = 0, \quad B_4 = -\frac{1}{30}, \dots$$

Apart from $B_1 = \frac{1}{2}$, all Bernoulli numbers with an odd index are zero, so $B_{2n-1} = 0, n = 2, 3, \dots$. The Bernoulli numbers with an even index B_{2n} follow by solving recursively these equations:

$$2. \quad B_0 = 1; \quad \sum_{k=0}^{n-1} \binom{n}{k} B_{2k} = 0, \quad k = 1, 2, \dots,$$

which are equivalent to the system given above.

The Bernoulli number B_{2n} is expressible in terms of Bernoulli numbers of lower index by

$$3. \quad B_{2n} = -\frac{1}{2n+1} + \frac{1}{2} - \sum_{k=2}^{2n-2} \frac{2n(2n-1)\cdots(2n-k+2)}{k!} B_k \quad [n \geq 1].$$

Short list of Bernoulli numbers.

$B_0 = 1$	$B_{12} = \frac{-691}{2730}$	$B_{24} = \frac{-236\,364\,091}{2730}$
$B_1 = -\frac{1}{2}$	$B_{14} = \frac{7}{6}$	$B_{26} = \frac{8\,553\,103}{6}$
$B_2 = \frac{1}{6}$	$B_{16} = \frac{-3617}{510}$	$B_{28} = \frac{-23\,749\,461\,029}{870}$
$B_4 = -\frac{1}{30}$	$B_{18} = \frac{43\,867}{798}$	$B_{30} = \frac{8\,615\,841\,276\,005}{14322}$
$B_6 = \frac{1}{42}$	$B_{20} = \frac{-174\,611}{330}$	$B_{32} = \frac{-7\,709\,321\,041\,217}{510}$
$B_8 = -\frac{1}{30}$	$B_{22} = \frac{854\,513}{138}$	$B_{34} = \frac{2\,577\,687\,858\,367}{6}$
$B_{10} = \frac{5}{66}$		

$$4. \quad B_{2n-1} = 0 \quad [n = 2, 3, \dots].$$

The **Euler numbers** E_n , all of which are integers, are defined as the coefficients of $t^n/n!$ on the right-hand side of the generating function

$$5. \quad \frac{2e^t}{e^t + 1} = \sum_{n=0}^{\infty} E_n \frac{t^n}{n!}.$$

As $2e^t/(e^t + 1) = 1/\cosh t$, it follows that $1/\cosh t$ is the generating function for Euler numbers. A procedure similar to the one described above for the determination of the Bernoulli numbers leads to the Euler numbers. Each Euler number with an odd index is zero.

Short list of Euler numbers.

$E_0 = 1$	$E_{12} = 2\,702\,765$
$E_2 = -1$	$E_{14} = -199\,360\,981$
$E_4 = 5$	$E_{16} = 19\,391\,512\,145$
$E_6 = -61$	$E_{18} = -2\,404\,879\,675\,441$
$E_8 = 1385$	$E_{20} = 370\,371\,188\,237\,525$
$E_{10} = -50\,521$	$E_{22} = -69\,348\,874\,393\,137\,901$

6. $E_{2n-1} = 0 \quad [n = 1, 2, \dots].$

Alternative definitions of Bernoulli and Euler numbers are in use, in which the indexing and choice of sign of the numbers differ from the conventions adopted here. Thus when reference is made to other sources using Bernoulli and Euler numbers it is essential to determine which definition is in use.

The most commonly used alternative definitions lead to the following sequences of Bernoulli numbers B_n^* and Euler numbers E_n^* , where an asterisk has been added to distinguish them from the numbers used throughout this book.

$$\begin{array}{ll}
 B_1^* = \frac{1}{6} & E_1^* = 1 \\
 B_2^* = \frac{1}{30} & E_2^* = 5 \\
 B_3^* = \frac{1}{42} & E_3^* = 61 \\
 B_4^* = \frac{1}{30} & E_4^* = 1385 \\
 B_5^* = \frac{5}{66} & E_5^* = 50521 \\
 \vdots & \vdots
 \end{array}$$

The relationships between these corresponding systems of Bernoulli and Euler numbers are as follows:

7. $B_{2n} = (-1)^{n+1} B_n^*, \quad E_{2n} = (-1)^n E_n^*, \quad [n = 1, 2, \dots].$

The generating function for the B_n^* is

8. $2 - \frac{t}{2} \cot \frac{t}{2} = \sum_{k=0}^{\infty} B_k^* \frac{t^{2k}}{(2k)!}$ with $B_0^* = 1$, while the generating function for the E_n^* is

9. $\sec t = \sum_{k=0}^{\infty} E_k^* \frac{t^{2k}}{(2k)!}$ with $E_0^* = 1$.

1.3.1.2 Series Representations for B_n and E_n

1. $B_{2n} = \frac{(-1)^{n+1} (2n)!}{\pi^{2n} 2^{2n-1}} \left[1 + \frac{1}{2^{2n}} + \frac{1}{3^{2n}} + \frac{1}{4^{2n}} + \cdots \right]$
2. $B_{2n} = \frac{(-1)^{n+1} (2n)!}{\pi^{2n} (2^{2n-1} - 1)} \left[1 - \frac{1}{2^{2n}} + \frac{1}{3^{2n}} - \frac{1}{4^{2n}} + \cdots \right]$
3. $E_{2n} = \frac{(-1)^n 2^{2n+2} (2n)!}{\pi^{2n+1}} \left[1 - \frac{1}{3^{2n+1}} + \frac{1}{5^{2n+1}} - \frac{1}{7^{2n+1}} + \cdots \right]$

1.3.1.3 Relationships Between B_n and E_n

1. $E_{2n} = - \left[\frac{(2n)!}{(2n-2)!} E_{2n-2} + \frac{(2n)!}{(2n-4)!} E_{2n-4} + \frac{(2n)!}{(2n-6)!} E_{2n-6} + \cdots + E_0 \right]$
 $E_0 = 1 \quad [n = 1, 2, \dots].$
2. $B_{2n} = \frac{2n}{2^{2n} (2^{2n} - 1)} \left[\frac{(2n-1)!}{(2n-2)!} E_{2n-2} + \frac{(2n-1)!}{(2n-4)!} E_{2n-4} \right.$
 $\left. + \frac{(2n-1)!}{(2n-6)!} E_{2n-6} + \cdots + E_0 \right]$
 $B_0 = 1, \quad B_1 = \frac{1}{2}, \quad E_0 = 1 \quad [n = 1, 2, \dots].$

1.3.1.4 The Occurrence of Bernoulli Numbers in Series

Bernoulli numbers enter into many summations, and their use can often lead to the form of the general term in a series expansion of a function that may be unobtainable by other means. For example, in terms of the Bernoulli numbers B_n , the generating function in 1.3.1.1 becomes

$$\frac{t}{e^t - 1} = 1 - \frac{1}{2}t + B_2 \frac{t^2}{2!} + B_4 \frac{t^4}{4!} + B_6 \frac{t^6}{6!} + \cdots.$$

However,

$$\frac{t}{e^t - 1} + \frac{t}{2} = \frac{t}{2} \coth \frac{t}{2},$$

so setting $t = 2x$ in the expansion gives

$$\begin{aligned} x \coth x &= 1 + 2^2 B_2 \frac{x^2}{2!} + 2^4 B_4 \frac{x^4}{4!} + 2^6 B_6 \frac{x^6}{6!} + \cdots \\ &= 1 + \sum_{k=1}^{\infty} 2^{2k} B_{2k} \frac{x^{2k}}{(2k)!} \end{aligned}$$

or

$$1. \quad \coth x = \frac{1}{x} + \sum_{k=1}^{\infty} 2^{2k} B_{2k} \frac{x^{2k-1}}{(2k)!} \quad [|x| < \pi].$$

Replacing x by ix this becomes

$$2. \quad \cot x = \frac{1}{x} + \sum_{k=1}^{\infty} (-1)^k 2^{2k} B_{2k} \frac{x^{2k-1}}{(2k)!} \quad [|x| < \pi].$$

The following series for $\tan x$ is obtained by combining the previous result with the identity $\tan x = \cot x - 2 \cot 2x$ (see 2.4.1.5.7):

$$3. \quad \tan x = \sum_{k=1}^{\infty} (-1)^{k+1} 2^{2k} (2^{2k} - 1) B_{2k} \frac{x^{2k-1}}{(2k)!} \quad [|x| < \pi/2].$$

1.3.1.5 Sums of Powers of Integers with Even or Odd Negative Exponents

$$1. \quad \sum_{k=1}^{\infty} \frac{1}{k^2} = \frac{1}{1^2} + \frac{1}{2^2} + \frac{1}{3^2} + \cdots = \frac{\pi^2}{6}$$

$$2. \quad \sum_{k=1}^{\infty} \frac{1}{k^4} = \frac{1}{1^4} + \frac{1}{2^4} + \frac{1}{3^4} + \cdots = \frac{\pi^4}{90}$$

$$3. \quad \sum_{k=1}^{\infty} \frac{1}{k^6} = \frac{1}{1^6} + \frac{1}{2^6} + \frac{1}{3^6} + \cdots = \frac{\pi^6}{945}$$

$$4. \quad \sum_{k=1}^{\infty} \frac{1}{k^8} = \frac{1}{1^8} + \frac{1}{2^8} + \frac{1}{3^8} + \cdots = \frac{\pi^8}{9450}$$

$$5. \quad \sum_{k=1}^{\infty} \frac{1}{k^{2n}} = (-1)^{n+1} \frac{(2\pi)^{2n} B_{2n}}{2 \cdot (2n)!} \quad [n = 1, 2, \dots]$$

$$6. \quad \sum_{k=1}^{\infty} (-1)^{k+1} \frac{1}{k^2} = \frac{1}{1^2} - \frac{1}{2^2} + \frac{1}{3^2} - \cdots = \frac{\pi^2}{12}$$

$$7. \quad \sum_{k=1}^{\infty} (-1)^{k+1} \frac{1}{k^4} = \frac{1}{1^4} - \frac{1}{2^4} + \frac{1}{3^4} - \cdots = \frac{7\pi^4}{720}$$

$$8. \quad \sum_{k=1}^{\infty} (-1)^{k+1} \frac{1}{k^6} = \frac{1}{1^6} - \frac{1}{2^6} + \frac{1}{3^6} - \cdots = \frac{31\pi^6}{30\,240}$$

$$9. \quad \sum_{k=1}^{\infty} (-1)^{k+1} \frac{1}{k^8} = \frac{1}{1^8} - \frac{1}{2^8} + \frac{1}{3^8} - \cdots = \frac{127\pi^8}{1\,209\,600}$$

$$10. \quad \sum_{k=1}^{\infty} (-1)^{k+1} \frac{1}{k^{2n}} = (-1)^{n+1} \frac{\pi^{2n} (2^{2n-1} - 1)}{(2n)!} B_{2n} \quad [n = 1, 2, \dots]$$

11.
$$\sum_{k=1}^{\infty} \frac{1}{(2k-1)^2} = \frac{1}{1^2} + \frac{1}{3^2} + \frac{1}{5^2} + \cdots = \frac{\pi^2}{8}$$
12.
$$\sum_{k=1}^{\infty} \frac{1}{(2k-1)^4} = \frac{1}{1^4} + \frac{1}{3^4} + \frac{1}{5^4} + \cdots = \frac{\pi^4}{96}$$
13.
$$\sum_{k=1}^{\infty} \frac{1}{(2k-1)^6} = \frac{1}{1^6} + \frac{1}{3^6} + \frac{1}{5^6} + \cdots = \frac{\pi^6}{960}$$
14.
$$\sum_{k=1}^{\infty} \frac{1}{(2k-1)^8} = \frac{1}{1^8} + \frac{1}{3^8} + \frac{1}{5^8} + \cdots = \frac{17\pi^8}{161\,280}$$
15.
$$\sum_{k=1}^{\infty} \frac{1}{(2k-1)^{2n}} = (-1)^{n+1} \frac{\pi^{2n} (2^{2n} - 1)}{2(2n)!} B_{2n} \quad [n = 1, 2, \dots]$$
16.
$$\sum_{k=1}^{\infty} (-1)^{k+1} \frac{1}{(2k-1)} = 1 - \frac{1}{3} + \frac{1}{5} - \cdots = \frac{\pi}{4}$$
17.
$$\sum_{k=1}^{\infty} (-1)^{k+1} \frac{1}{(2k-1)^3} = 1 - \frac{1}{3^3} + \frac{1}{5^3} - \cdots = \frac{\pi^2}{32}$$
18.
$$\sum_{k=1}^{\infty} (-1)^{k+1} \frac{1}{(2k-1)^5} = 1 - \frac{1}{3^5} + \frac{1}{5^5} - \cdots = \frac{5\pi^5}{1536}$$
19.
$$\sum_{k=1}^{\infty} (-1)^{k+1} \frac{1}{(2k-1)^7} = 1 - \frac{1}{3^7} + \frac{1}{5^7} - \cdots = \frac{61\pi^7}{184\,320}$$
20.
$$\sum_{k=1}^{\infty} (-1)^{k+1} \frac{1}{(2k-1)^{2n+1}} = (-1)^n \frac{\pi^{2n+1}}{2^{2n+2} (2n)!} E_{2n} \quad [n = 0, 1, \dots]$$

1.3.1.6 Asymptotic Representations for B_{2n}

1.
$$B_{2n} \sim (-1)^{n+1} \frac{2(2n)!}{(2\pi)^{2n}}$$
2.
$$B_{2n} \sim (-1)^{n+1} 4(\pi n)^{1/2} \left(\frac{n}{\pi e}\right)^{2n}$$
3.
$$\frac{B_{2n}}{B_{2n+2}} \sim \frac{-4\pi^2}{(2n+1)(2n+2)}$$
4.
$$\frac{B_{2n}}{B_{2n+2}} \sim -\left(\frac{\pi e}{n+1}\right)^2 \left(\frac{n}{n+1}\right)^{2n}$$

1.3.2 Bernoulli and Euler Polynomials

1.3.2.1 The Bernoulli Polynomials

The Bernoulli polynomials $B_n(x)$ are defined by

$$1. \quad B_n(x) = \sum_{k=0}^n \binom{n}{k} B_k x^{n-k},$$

and they have as their generating function

$$2. \quad \frac{e^{xt}}{e^t - 1} = \sum_{n=0}^{\infty} B_n(x) \frac{t^{n-1}}{n!}.$$

The first eight Bernoulli polynomials are

$$3. \quad B_0(x) = 1$$

$$4. \quad B_1(x) = x - \frac{1}{2}$$

$$5. \quad B_2(x) = x^2 - x + \frac{1}{6}$$

$$6. \quad B_3(x) = x^3 - \frac{3}{2}x^2 + \frac{1}{2}x$$

$$7. \quad B_4(x) = x^4 - 2x^3 + x^2 - \frac{1}{30}$$

$$8. \quad B_5(x) = x^5 - \frac{5}{2}x^4 + \frac{5}{3}x^3 - \frac{1}{6}x$$

$$9. \quad B_6(x) = x^6 - 3x^5 + \frac{5}{2}x^4 - \frac{1}{2}x^2 + \frac{1}{42}$$

$$10. \quad B_7(x) = x^7 - \frac{7}{2}x^6 + \frac{7}{2}x^5 - \frac{7}{6}x^3 + \frac{1}{6}x$$

The Bernoulli numbers B_n are related to the Bernoulli polynomials $B_n(x)$ by

$$11. \quad B_n = B_n(0) \quad [n = 0, 1, \dots].$$

1.3.2.2 Functional Relations and Properties of Bernoulli Polynomials

$$1. \quad B_{m+1}(n) = B_{m+1} + (m+1) \sum_{k=1}^{n-1} k^m \quad [m, n \text{ natural numbers}]$$

$$2. \quad B_n(x+1) - B_n(x) = nx^{n-1} \quad [n = 0, 1, \dots]$$

$$3. \quad B_n(1-x) = (-1)^n B_n(x) \quad [n = 0, 1, \dots]$$

$$4. \quad (-1)^n B_n(-x) = B_n(x) + nx^{n-1} \quad [n = 0, 1, \dots]$$

$$5. \quad B_n(mx) = m^{n-1} \sum_{k=0}^{m-1} B_n\left(x + \frac{k}{m}\right) \quad [m = 1, 2, \dots, n = 0, 1, \dots]$$

$$6. \quad B'_n(x) = nB_{n-1}(x) \quad [n = 1, 2, \dots]$$

$$7. \quad \sum_{k=1}^m k^n = \frac{B_{n+1}(m+1) - B_{n+1}}{n+1} \quad [m, n = 1, 2, \dots]$$

$$8. \quad B_n(x+h) = \sum_{k=0}^n \binom{n}{k} B_k(x) h^{n-k} \quad [n = 0, 1, \dots]$$

1.3.2.3 The Euler Polynomials

The Euler polynomials $E_n(x)$ are defined by

$$1. \quad E_n(x) = \sum_{k=0}^n \binom{n}{k} \frac{E_k}{2^k} \left(x - \frac{1}{2}\right)^{n-k},$$

and they have as their generating function

$$2. \quad \frac{2e^{xt}}{e^t + 1} = \sum_{n=0}^{\infty} E_n(x) \frac{t^n}{n!}.$$

The first eight Euler polynomials are

$$3. \quad E_0(x) = 1$$

$$4. \quad E_1(x) = x - \frac{1}{2}$$

$$5. \quad E_2(x) = x^2 - x$$

$$6. \quad E_3(x) = x^3 - \frac{3}{2}x^2 + \frac{1}{4}$$

$$7. \quad E_4(x) = x^4 - 2x^3 + x$$

$$8. \quad E_5(x) = x^5 - \frac{5}{2}x^4 + \frac{5}{2}x^2 - \frac{1}{2}$$

$$9. \quad E_6(x) = x^6 - 3x^5 + 5x^3 - 3x$$

$$10. \quad E_7(x) = x^7 - \frac{7}{2}x^6 + \frac{35}{4}x^4 - \frac{21}{2}x^2 + \frac{17}{8}$$

The Euler numbers E_n are related to the Euler polynomials $E_n(x)$ by

$$11. \quad E_n = 2^n E_n\left(\frac{1}{2}\right) \quad (\text{an integer}) \quad [n = 0, 1, \dots]$$

1.3.2.4 Functional Relations and Properties of Euler Polynomials

$$1. \quad E_m(n+1) = 2 \sum_{k=1}^n (-1)^{n-k} k^m + (-1)^{n+1} E_m(0) \quad [m, n \text{ natural numbers}]$$

$$2. \quad E_n(x+1) + E_n(x) = 2x^n \quad [n = 0, 1, \dots]$$

3. $E_n(1-x) = (-1)^n E_n(x) \quad [n = 0, 1, \dots]$
4. $(-1)^{n+1} E_n(-x) = E_n(x) - 2x^n \quad [n = 0, 1, \dots]$
5. $E_n(mx) = m^n \sum_{k=0}^{m-1} (-1)^k E_n\left(x + \frac{k}{m}\right) \quad [n = 0, 1, \dots, m = 1, 3, \dots]$
6. $E'_n(x) = nE_{n-1}(x) \quad [n = 1, 2, \dots]$
7. $\sum_{k=1}^m (-1)^{m-k} k^n = \frac{E_n(m+1) + (-1)^m E_n(0)}{2} \quad [m, n = 1, 2, \dots]$
8. $E_n(x+h) = \sum_{k=0}^n \binom{n}{k} E_k(x) h^{n-k} \quad [n = 0, 1, \dots]$

1.3.3 The Euler–Maclaurin Summation Formula

Let $f(x)$ have continuous derivatives of all orders up to and including $2m+2$ for $0 \leq x \leq n$. Then if $a_k = f(k)$, the sum $\sum_{k=0}^n f(k) = \sum_{k=0}^n a_k$ determined by the **Euler–Maclaurin summation formula** is given by

$$\sum_{k=0}^n a_k = \int_0^n f(t) dt + \frac{1}{2} [f(0) + f(n)] + \sum_{k=1}^m \frac{B_{2k}}{(2k)!} [f^{(2k-1)}(n) - f^{(2k-1)}(0)] + R_m,$$

where the remainder term is

$$R_m = \frac{nB_{2m+2}}{(2m+2)!} f^{(2m+2)}(\theta n) \quad \text{with } 0 < \theta < 1 \quad [m, n = 1, 2, \dots].$$

In special cases this formula yields an exact closed-form solution for the required sum, whereas in others it provides an asymptotic result. For example, if $f(x) = x^2$, the summation formula yields an exact result for $\sum_{k=1}^n n^2$, because every term after the one in B_2 is identically zero, including the remainder term R_1 . The details of the calculations are as follows:

$$\begin{aligned} \sum_{k=0}^n k^2 &= \sum_{k=1}^n k^2 = \int_0^n t^2 dt + \frac{1}{2}n^2 + \frac{B_2}{2!} \cdot 2n \\ &= \frac{1}{3}n^3 + \frac{1}{2}n^2 + \frac{1}{6}n = \frac{1}{6}(n+1)(2n+1). \end{aligned} \quad (\text{see 1.2.3.1.2})$$

However, no closed-form expression exists for $\sum_{k=1}^n 1/k^2$, so when applied to this case the formula can only yield an approximate sum. Setting $f(x) = 1/(x+1)^2$ in the summation formula gives

$$\sum_{k=0}^n \frac{1}{(k+1)^2} = \frac{1}{1^2} + \frac{1}{2^2} + \dots + \frac{1}{(n+1)^2} \approx \int_0^n \frac{dt}{(t+1)^2}$$

$$\begin{aligned}
& + \frac{1}{2} \left(1 + \frac{1}{(n+1)^2} \right) + \sum_{k=1}^m B_{2k} \left[1 - \frac{1}{(n+1)^{2k+1}} \right] + R_m \\
& = \left(1 - \frac{1}{n+1} \right) + \frac{1}{2} \left(1 + \frac{1}{(n+1)^2} \right) + \sum_{k=1}^m B_{2k} \left[1 - \frac{1}{(n+1)^{2k+1}} \right] + R_m.
\end{aligned}$$

To illustrate matters, setting $n = 149$, $m = 1$, and neglecting R_1 gives the rather poor approximation 1.660 022 172 to the actual result

$$\sum_{k=0}^{149} 1/(k+1)^2 = \sum_{k=1}^{150} 1/k^2 = 1.638\,289\,573\dots$$

obtained by direct calculation. Increasing m only yields a temporary improvement, because for large m , the numbers $|B_{2m}|$ increase like $(2m)!$ while alternating in sign, which causes the sum to oscillate unboundedly.

A more accurate result is obtained by summing, say, the first 9 terms numerically to obtain $\sum_{k=1}^9 1/k^2 = 1.539\,767\,731$, and then using the summation formula to estimate $\sum_{k=10}^{150} 1/k^2$. This is accomplished by setting $f(x) = 1/(x+10)^2$ in the summation formula, because

$$\sum_{k=0}^{140} f(k) = \sum_{k=10}^{150} 1/k^2 = \frac{1}{10^2} + \frac{1}{11^2} + \dots + \frac{1}{150^2}.$$

This time, again setting $m = 1$ and neglecting R_1 gives

$$\sum_{k=0}^{150} 1/k^2 \approx \left(\frac{1}{10} - \frac{1}{150} \right) + \frac{1}{2} \left(\frac{1}{10^2} + \frac{1}{150^2} \right) + \frac{1}{6} \left(\frac{1}{10^3} - \frac{1}{150^3} \right) = 0.098\,522\,173.$$

Thus $\sum_{k=1}^{150} 1/k^2 \approx 1.539\,767\,731 + 0.098\,522\,173 = 1.638\,289\,904$, which is now accurate to six decimal places.

1.3.4 Accelerating the Convergence of Alternating Series

An alternating series has the form $\sum_{r=0}^{\infty} (-1)^r a_r$ with the $a_r > 0$, and it converges when $a_{r+1} < a_r$ and $\lim_{r \rightarrow \infty} a_r = 0$. Let the alternating series $\sum_{r=0}^{\infty} (-1)^r a_r$ be convergent to the sum S . If $s_n = \sum_{r=0}^n (-1)^r a_r$ is the n th partial sum of the series and R_n is the remainder so that $S = s_n + R_n$, then $0 < |R_n| < a_{n+1}$. This estimate of the error caused by neglecting the remainder R_n implies that $\frac{1}{2}(s_n + s_{n+1})$ is a better approximation to the sum S than either s_n or s_{n+1} . If for some choice of N a sequence of $M+1$ values of s_n is computed for $n = N, N+1, N+2, \dots, N+M$, the above approach can be applied to successive pairs of values of s_n to generate a new set of M improved approximations to S denoted collectively by S_1 . A repetition of this process using the approximations in S_1 will generate another set of $M-1$ better approximations to S denoted collectively by S_2 . Proceeding in this manner,

sets of increasingly accurate approximations are generated until at the M th stage only one approximation remains in the set S_M , and this is the required improved approximation to S .

The approach is illustrated in the following tabulation where it is applied to the following alternating series with a known sum

$$\sum_{r=0}^{\infty} \frac{(-1)^r}{(r+1)^2} = \frac{\pi^2}{12}.$$

Setting $s_n = \sum_{r=0}^n \frac{(-1)^r}{(r+1)^2}$ and applying the averaging method to s_5, s_6, s_7, s_8 , and s_9 gives the following results, where each entry in column S_m is obtained by averaging the entries that lie immediately above and below it in the previous column S_{m-1} .

n	s_n	S_1	S_2	S_3	S_4
5	0.810833				
		0.821037			
6	0.831241		0.822233		
		0.823429		0.822421	
7	0.815616		0.822609		0.822457
		0.821789		0.822493	
8	0.827962		0.822376		
		0.822962			
9	0.817962				

The final approximation 0.822457 in column S_4 should be compared with the correct value that to six decimal places is 0.822467. To obtain this accuracy by direct summation would necessitate summing approximately 190 terms. The convergence of the approximation can be seen by examining the number of decimal places that remain unchanged in each column S_m . Improved accuracy can be achieved either by using a larger set of values s_n , or by starting with a large value of n .

1.4 DETERMINANTS

1.4.1 Expansion of Second- and Third-Order Determinants

1.4.1.1

The **determinant** associated with the 2×2 matrix

- $\mathbf{A} = \begin{bmatrix} a_{11} & a_{12} \\ a_{21} & a_{22} \end{bmatrix}$, (see 1.5.1.1.1)

with elements a_{ij} comprising real or complex numbers, or functions, denoted either by $|\mathbf{A}|$ or by $\det \mathbf{A}$, is defined by

- $|\mathbf{A}| = a_{11}a_{22} - a_{12}a_{21}$.

This is called a **second-order** determinant.

The determinant associated with the 3×3 matrix

$$\mathbf{A} = \begin{bmatrix} a_{11} & a_{12} & a_{13} \\ a_{21} & a_{22} & a_{23} \\ a_{31} & a_{32} & a_{33} \end{bmatrix},$$

with elements a_{ij} comprising real or complex numbers, or functions, is defined by

$$3. \quad |\mathbf{A}| = a_{11}a_{22}a_{33} - a_{11}a_{23}a_{32} + a_{12}a_{23}a_{31} - a_{12}a_{21}a_{32} + a_{13}a_{21}a_{32} - a_{13}a_{22}a_{31}.$$

This is called a **third-order** determinant.

1.4.2 Minors, Cofactors, and the Laplace Expansion

1.4.2.1

The $n \times n$ matrix

$$1. \quad \mathbf{A} = \begin{bmatrix} a_{11} & a_{12} & \cdots & a_{1n} \\ a_{21} & a_{22} & \cdots & a_{2n} \\ \vdots & \vdots & \vdots & \vdots \\ a_{n1} & a_{n2} & \cdots & a_{nn} \end{bmatrix}$$

has associated with it the determinant

$$2. \quad |\mathbf{A}| = \begin{vmatrix} a_{11} & a_{12} & \cdots & a_{1n} \\ a_{21} & a_{22} & \cdots & a_{2n} \\ \vdots & \vdots & \vdots & \vdots \\ a_{n1} & a_{n2} & \cdots & a_{nn} \end{vmatrix}$$

The **order** of a determinant is the number of elements in its leading diagonal (the diagonal from top left to bottom right), so an **n 'th-order** determinant is associated with an $n \times n$ matrix. The Laplace expansion of a determinant of arbitrary order is given later.

The **minor** M_{ij} associated with the element a_{ij} in 1.4.2.1.1 is the $(n - 1)$ th-order determinant derived from 1.4.2.1.1 by deletion of its i 'th row and j 'th column. The **cofactor** C_{ij} associated with the element a_{ij} is defined as

$$3. \quad C_{ij} = (-1)^{i+j} M_{ij}.$$

The **Laplace expansion** of determinant 1.4.2.1.1 may be either by elements of a row or of a column of $|\mathbf{A}|$.

Laplace expansion of $|\mathbf{A}|$ by elements of the i 'th row.

$$4. \quad |\mathbf{A}| = \sum_{j=1}^n a_{ij} C_{ij} \quad [i = 1, 2, \dots, n].$$

Laplace expansion of $|\mathbf{A}|$ by elements of the j 'th column.

$$5. \quad |\mathbf{A}| = \sum_{i=1}^n a_{ij} C_{ij} \quad [j = 1, 2, \dots, n].$$

A related property of determinants is that the sum of the products of the elements in any row and the cofactors of the corresponding elements in any other row is zero. Similarly, the sum of the products of the elements in any column and the cofactors of the corresponding elements in any other column is zero. Thus for a determinant of any order

$$6. \sum_{j=1}^n a_{ij}C_{kj} = 0 \quad [j \neq k, i = 1, 2, \dots, n]$$

and

$$7. \sum_{i=1}^n a_{ij}C_{ik} = 0 \quad [j \neq k, j = 1, 2, \dots, n].$$

If the **Kronecker delta** symbol δ_{ij} is introduced, where

$$8. \delta_{ij} = \begin{cases} 1, & i = j \\ 0, & i \neq j, \end{cases}$$

results 1.4.2.1.4-7 may be combined to give

$$9. \sum_{j=1}^n a_{ij}C_{kj} = \delta_{ik} |\mathbf{A}| \quad \text{and} \quad \sum_{i=1}^n a_{ij}C_{ik} = \delta_{jk} |\mathbf{A}|.$$

These results may be illustrated by considering the matrix

$$\mathbf{A} = \begin{bmatrix} 1 & 2 & 1 \\ -2 & 4 & -1 \\ 2 & 1 & 3 \end{bmatrix}$$

and its associated determinant $|\mathbf{A}|$. Expanding $|\mathbf{A}|$ by elements of its second row gives

$$|\mathbf{A}| = -2C_{21} + 4C_{22} - C_{23},$$

but

$$C_{21} = (-1)^{2+1} \begin{vmatrix} 2 & 1 \\ 1 & 3 \end{vmatrix} = -5, \quad C_{22} = (-1)^{2+2} \begin{vmatrix} 1 & 1 \\ 2 & 3 \end{vmatrix} = 1,$$

$$C_{23} = (-1)^{2+3} \begin{vmatrix} 1 & 2 \\ 2 & 1 \end{vmatrix} = 3,$$

so

$$|\mathbf{A}| = (-2) \cdot (-5) + 4 \cdot (1) - 3 = 11.$$

Alternatively, expanding $|\mathbf{A}|$ by elements of its first column gives

$$|\mathbf{A}| = C_{11} - 2C_{21} + 2C_{31},$$

but

$$C_{11} = (-1)^{1+1} \begin{vmatrix} 4 & -1 \\ 1 & 3 \end{vmatrix} = 13, \quad C_{21} = (-1)^{2+1} \begin{vmatrix} 2 & 1 \\ 1 & 3 \end{vmatrix} = -5,$$

$$C_{31} = (-1)^{3+1} \begin{vmatrix} 2 & 1 \\ 4 & -1 \end{vmatrix} = -6,$$

so

$$|\mathbf{A}| = 13 - 2 \cdot (-5) + 2 \cdot (-6) = 11.$$

To verify 1.4.2.1.6 we sum the products of elements in the first row of $|\mathbf{A}|$ ($i = 1$) and the cofactors of the corresponding elements in the second row of $|\mathbf{A}|$ ($k = 2$) to obtain

$$\begin{aligned} \sum_{j=1}^3 a_{1j}C_{2j} &= a_{11}C_{21} + a_{12}C_{22} + a_{13}C_{23} \\ &= 1 \cdot (-5) + 2 \cdot 1 + 1 \cdot 3 = 0. \end{aligned}$$

1.4.3 Basic Properties of Determinants

1.4.3.1

Let $\mathbf{A} = [a_{ij}]$, $\mathbf{B} = [b_{ij}]$ be $n \times n$ matrices, when the following results are true.

1. If any two adjacent rows (or columns) of $|\mathbf{A}|$ are interchanged, the sign of the resulting determinant is changed.
2. If any two rows (or columns) of $|\mathbf{A}|$ are identical, then $|\mathbf{A}| = 0$.
3. The value of a determinant is not changed if any multiple of a row (or column) is added to any other row (or column).
4. $|k\mathbf{A}| = k^n |\mathbf{A}|$ for any scalar k .
5. $|\mathbf{A}^T| = |\mathbf{A}|$, where \mathbf{A}^T is the transpose of \mathbf{A} . (see 1.5.1.1.7)
6. $|\mathbf{A}| |\mathbf{B}| = |\mathbf{AB}|$. (see 1.5.1.1.27)
7. $|\mathbf{A}^{-1}| = 1/|\mathbf{A}|$, where \mathbf{A}^{-1} is the matrix inverse to \mathbf{A} . (see 1.5.1.1.9)
8. If the elements a_{ij} of \mathbf{A} are functions of x , then

$$\frac{d|\mathbf{A}|}{dx} = \sum_{i,j=1}^n \frac{da_{ij}}{dx} C_{ij}, \quad \text{where } C_{ij} \text{ is the cofactor of the element } a_{ij}.$$

1.4.4 Jacobi's Theorem

1.4.4.1

Let M_r be an r -rowed minor of the n th-order determinant $|\mathbf{A}|$, associated with the $n \times n$ matrix $\mathbf{A} = [a_{ij}]$, in which the rows i_1, i_2, \dots, i_r are represented together with the columns k_1, k_2, \dots, k_r .

Define the **complementary minor** to M_r to be the $(n - k)$ -rowed minor obtained from $|\mathbf{A}|$ by deleting all the rows and columns associated with M_r , and the **signed complementary minor** $M^{(r)}$ to M_r to be

1. $M^{(r)} = (-1)^{i_1+i_2+\dots+i_r+k_1+k_2+\dots+k_r} \times (\text{complementary minor to } M_r)$.
Then, if Δ is the matrix of cofactors given by

$$2. \quad \Delta = \begin{pmatrix} C_{11} & C_{12} & \cdots & C_{1n} \\ C_{21} & C_{22} & \cdots & C_{2n} \\ \vdots & \vdots & \vdots & \vdots \\ C_{n1} & C_{n2} & \cdots & C_{nn} \end{pmatrix},$$

and M_r and M'_r are corresponding r -rowed minors of $|\mathbf{A}|$ and Δ , it follows that

3. $M'_r = |\mathbf{A}|^{r-1} M^{(r)}$.

It follows that if $|\mathbf{A}| = 0$, then

4. $C_{pk}C_{nq} = C_{nk}C_{pq}$.

1.4.5 Hadamard's Theorem

1.4.5.1

If $|\mathbf{A}|$ is an $n \times n$ determinant with elements a_{ij} that may be complex, then $|\mathbf{A}| \neq 0$ if

1. $|a_{ii}| > \sum_{j=1, j \neq i}^n |a_{ij}|$.

1.4.6 Hadamard's Inequality

1.4.6.1

Let $\mathbf{A} = [a_{ij}]$ be an arbitrary $n \times n$ nonsingular matrix with real elements and determinant $|\mathbf{A}|$. Then

1. $|\mathbf{A}|^2 \leq \prod_{i=1}^n \left(\sum_{k=1}^n a_{ik}^2 \right)$.

This result remains true if \mathbf{A} has complex elements but is such that $\mathbf{A} = \overline{\mathbf{A}}^T$ (\mathbf{A} is **hermitian**), where $\overline{\mathbf{A}}$ denotes the matrix obtained from \mathbf{A} by replacing each element by its complex conjugate and T denotes the transpose operation (see 1.5.1.1.7).

Deductions

1. If $M = \max |a_{ij}|$, then

$$|\mathbf{A}| \leq M^n n^{n/2}.$$

2. If the $n \times n$ matrix $\mathbf{A} = [a_{ij}]$ is positive definite (see 1.5.1.1.21), then

$$|\mathbf{A}| \leq a_{11}a_{22} \cdots a_{nn}.$$

3. If the real $n \times n$ matrix \mathbf{A} is **diagonally dominant**, that is if

$$\sum_{j \neq i}^n |a_{ij}| < |a_{ii}| \quad \text{for } i = 1, 2, \dots, n,$$

then $|\mathbf{A}| \neq 0$.

1.4.7 Cramer's Rule

1.4.7.1

If n linear equations

1. $a_{11}x_1 + a_{12}x_2 + \dots + a_{1n}x_n = b_1,$
 $a_{21}x_1 + a_{22}x_2 + \dots + a_{2n}x_n = b_2,$
 $\vdots \quad \quad \quad \vdots \quad \quad \quad \vdots$
 $a_{n1}x_1 + a_{n2}x_2 + \dots + a_{nn}x_n = b_n,$

have a **nonsingular** coefficient matrix $\mathbf{A} = [a_{ji}]$, so that $|\mathbf{A}| \neq 0$, then there is a unique solution

2. $x_j = \frac{C_{1j}b_1 + C_{2j}b_2 + \dots + C_{nj}b_n}{|\mathbf{A}|}$

for $j = 1, 2, \dots, n$, where C_{ij} is the cofactor of element a_{ij} in the coefficient matrix \mathbf{A} (**Cramer's rule**).

1.4.8 Some Special Determinants

1.4.8.1 Vandermonde's Determinant (Alternant)

1. *Third order*

$$\begin{vmatrix} 1 & 1 & 1 \\ x_1 & x_2 & x_3 \\ x_1^2 & x_2^2 & x_3^2 \end{vmatrix} = (x_3 - x_2)(x_3 - x_1)(x_2 - x_1).$$

2. *n'th order*

$$\begin{vmatrix} 1 & 1 & \dots & 1 \\ x_1 & x_2 & \dots & x_n \\ x_1^2 & x_2^2 & \dots & x_n^2 \\ \vdots & \vdots & \vdots & \vdots \\ x_1^{n-1} & x_2^{n-1} & \dots & x_n^{n-1} \end{vmatrix} = \prod_{1 \leq i < j \leq n} (x_j - x_i),$$

where the right-hand side is the continued product of all the differences that can be formed from the $\frac{1}{2}n(n-1)$ pairs of numbers taken from x_1, x_2, \dots, x_n , with the order of the differences taken in the reverse order of the suffixes that are involved.

1.4.8.2 Circulants

3. *Second order*

$$\begin{vmatrix} x_1 & x_2 \\ x_2 & x_1 \end{vmatrix} = (x_1 + x_2)(x_1 - x_2).$$

4. *Third order*

$$\begin{vmatrix} x_1 & x_2 & x_3 \\ x_3 & x_1 & x_2 \\ x_2 & x_3 & x_1 \end{vmatrix} = (x_1 + x_2 + x_3)(x_1 + \omega x_2 + \omega^2 x_3)(x_1 + \omega^2 x_2 + \omega x_3),$$

where ω and ω^2 are the two complex cube roots of 1.

5. *n'th order*

$$\begin{vmatrix} x_1 & x_2 & x_3 & \cdots & x_n \\ x_n & x_1 & x_2 & \cdots & x_{n-1} \\ x_{n-1} & x_n & x_1 & \cdots & x_{n-2} \\ \vdots & \vdots & \vdots & \ddots & \vdots \\ x_2 & x_3 & x_4 & \cdots & x_1 \end{vmatrix} = \prod_{j=1}^{n-1} (x_1 + x_2 \omega_j + x_3 \omega_j^2 + \cdots + x_n \omega_j^{n-1}),$$

where ω_j is an n th root of 1.

The eigenvalues λ (see 1.5.11.18) of an $n \times n$ circulant matrix are

$$\lambda_j = x_1 + x_2 \omega_j + x_3 \omega_j^2 + \cdots + x_n \omega_j^{n-1},$$

where ω_j is again an n 'th root of 1.

1.4.8.3 Jacobian Determinants

If f_1, f_2, \dots, f_n are n real-valued functions that are differentiable with respect to x_1, x_2, \dots, x_n , then the Jacobian $J_f(x)$ of the f_i with respect to the x_j is the determinant

$$1. \quad J_f(x) = \begin{vmatrix} \frac{\partial f_1}{\partial x_1} & \frac{\partial f_1}{\partial x_2} & \cdots & \frac{\partial f_1}{\partial x_n} \\ \frac{\partial f_2}{\partial x_1} & \frac{\partial f_2}{\partial x_2} & \cdots & \frac{\partial f_2}{\partial x_n} \\ \vdots & \vdots & \ddots & \vdots \\ \frac{\partial f_n}{\partial x_1} & \frac{\partial f_n}{\partial x_2} & \cdots & \frac{\partial f_n}{\partial x_n} \end{vmatrix}.$$

The notation

$$2. \quad \frac{\partial (f_1, f_2, \dots, f_n)}{\partial (x_1, x_2, \dots, x_n)}$$

is also used to denote the Jacobian $J_f(x)$.

1.4.8.4 Hessian Determinants

The Jacobian of the derivatives $\partial\phi/\partial x_1, \partial\phi/\partial x_2, \dots, \partial\phi/\partial x_n$ of a function $\phi(x_1, x_2, \dots, x_n)$ with respect to x_1, x_2, \dots, x_n is called the **Hessian** H of ϕ , so that

$$1. \quad H = \begin{vmatrix} \frac{\partial^2\phi}{\partial x_1^2} & \frac{\partial^2\phi}{\partial x_1\partial x_2} & \frac{\partial^2\phi}{\partial x_1\partial x_3} & \cdots & \frac{\partial^2\phi}{\partial x_1\partial x_n} \\ \frac{\partial^2\phi}{\partial x_2\partial x_1} & \frac{\partial^2\phi}{\partial x_2^2} & \frac{\partial^2\phi}{\partial x_2\partial x_3} & \cdots & \frac{\partial^2\phi}{\partial x_2\partial x_n} \\ \vdots & \vdots & \vdots & \cdots & \vdots \\ \frac{\partial^2\phi}{\partial x_n\partial x_1} & \frac{\partial^2\phi}{\partial x_n\partial x_2} & \frac{\partial^2\phi}{\partial x_n\partial x_3} & \cdots & \frac{\partial^2\phi}{\partial x_n^2} \end{vmatrix}.$$

1.4.8.5 Wronskian Determinants

Let f_1, f_2, \dots, f_n be n functions, each n times differentiable with respect to x in some open interval (a, b) . Then the Wronskian $W(x)$ of f_1, f_2, \dots, f_n is defined by

$$1. \quad W(x) = \begin{vmatrix} f_1 & f_2 & \cdots & f_n \\ f_1^{(1)} & f_2^{(1)} & \cdots & f_n^{(1)} \\ \vdots & \vdots & \vdots & \vdots \\ f_1^{(n-1)} & f_2^{(n-1)} & \cdots & f_n^{(n-1)} \end{vmatrix},$$

where $f_i^{(r)} = d^r f_i / dx^r$.

Properties of Wronskian determinants.

2. dW/dx follows from $W(x)$ by replacing the last row of the determinant defining $W(x)$ by the n 'th derivatives $f_1^{(n)}, f_2^{(n)}, \dots, f_n^{(n)}$.
3. If constants k_1, k_2, \dots, k_n exist, not all zero, such that

$$k_1 f_1 + k_2 f_2 + \cdots + k_n f_n = 0$$

for all x in (a, b) , then $W(x) = 0$ for all x in (a, b) .

4. The vanishing of the Wronskian throughout (a, b) is necessary, but not sufficient, for the linear dependence of f_1, f_2, \dots, f_n .

1.4.9 Routh–Hurwitz Theorem

1.4.9.1

Let $P(\lambda)$ be the n th degree polynomial

$$1. \quad P(\lambda) \equiv \lambda^n + a_1 \lambda^{n-1} + a_2 \lambda^{n-2} + \cdots + a_n.$$

Form the n numbers:

$$2. \quad \Delta_1 = a_1, \quad \Delta_2 = \begin{vmatrix} a_1 & 1 \\ a_3 & a_2 \end{vmatrix}, \quad \Delta_3 = \begin{vmatrix} a_1 & 1 & 0 \\ a_3 & a_2 & a_1 \\ a_5 & a_4 & a_3 \end{vmatrix}, \dots,$$

$$\Delta_n = \begin{vmatrix} a_1 & 1 & 0 & 0 & \dots & 0 \\ a_3 & a_2 & a_1 & 1 & \dots & 0 \\ a_5 & a_4 & a_3 & a_2 & \dots & 0 \\ \vdots & \vdots & \vdots & \vdots & \vdots & \vdots \\ a_{2n-1} & a_{2n-2} & a_{2n-3} & a_{2n-4} & \dots & a_n \end{vmatrix},$$

and set $a_r = 0$ for $r > n$.

- Then the necessary and sufficient conditions for the zeros of $P(\lambda)$ all to have negative real parts (the **Routh–Hurwitz conditions**) are

$$\Delta_i > 0 \quad [i = 1, 2, \dots, n].$$

1.5 MATRICES

1.5.1 Special Matrices

1.5.1.1 Basic Definitions

- An $m \times n$ **matrix** is a rectangular array of elements (numbers or functions) with m rows and n columns. If a matrix is denoted by \mathbf{A} , the element (entry) in its i 'th row and j 'th column is denoted by a_{ij} , and we write $\mathbf{A} = [a_{ij}]$. A matrix with as many rows as columns is called a **square matrix**.
- A square matrix \mathbf{A} of the form

$$\mathbf{A} = \begin{bmatrix} \lambda_1 & 0 & 0 & \dots & 0 \\ 0 & \lambda_2 & 0 & \dots & 0 \\ 0 & 0 & \lambda_3 & \dots & 0 \\ \vdots & \vdots & \vdots & \vdots & \vdots \\ 0 & 0 & 0 & \dots & \lambda_n \end{bmatrix}$$

in which all entries away from the **leading diagonal** (the diagonal from top left to bottom right) are zero is called a **diagonal matrix**. This diagonal matrix is often abbreviated as $\mathbf{A} = \text{diag}\{\lambda_1, \lambda_2, \dots, \lambda_n\}$, where the order in which the elements $\lambda_1, \lambda_2, \dots, \lambda_n$ appear in this notation is the order in which they appear on the leading diagonal of \mathbf{A} .

- The **identity matrix**, or **unit matrix**, is a diagonal matrix \mathbf{I} in which all entries in the leading diagonal are unity.
- A **null matrix** is a matrix of any shape in which every entry is zero.

5. The $n \times n$ matrix $\mathbf{A} = [a_{ij}]$ is said to be **reducible** if the indices $1, 2, \dots, n$ can be divided into two disjoint nonempty sets $i_1, i_2, \dots, i_\mu; j_1, j_2, \dots, j_\nu$ ($\mu + \nu = n$), such that

$$a_{i_\alpha j_\beta} = 0 \quad [\alpha = 1, 2, \dots, \mu; \beta = 1, 2, \dots, \nu].$$

Otherwise \mathbf{A} will be said to be **irreducible**.

6. An $m \times n$ matrix \mathbf{A} is **equivalent** to an $m \times n$ matrix \mathbf{B} if, and only if, $\mathbf{B} = \mathbf{PAQ}$ for suitable **nonsingular** $m \times m$ and $n \times n$ matrices \mathbf{P} and \mathbf{Q} , respectively. A matrix \mathbf{D} is said to be **nonsingular** if $|\mathbf{D}| \neq 0$.
7. If $\mathbf{A} = [a_{ij}]$ is an $m \times n$ matrix with element a_{ij} in its i 'th row and the j 'th column, then the **transpose** \mathbf{A}^T of \mathbf{A} is $n \times m$ matrix

$$\mathbf{A}^T = [b_{ij}] \quad \text{with } b_{ij} = a_{ji};$$

that is, the transpose \mathbf{A}^T of \mathbf{A} is the matrix derived from \mathbf{A} by interchanging rows and columns, so the i 'th row of \mathbf{A} becomes the i 'th column of \mathbf{A}^T for $i = 1, 2, \dots, m$.

8. If \mathbf{A} is an $n \times n$ matrix, its **adjoint**, denoted by $\text{adj } \mathbf{A}$, is the transpose of the matrix of cofactors C_{ij} of \mathbf{A} , so that

$$\text{adj } \mathbf{A} = [C_{ij}]^T. \quad (\text{see 1.4.2.1.3})$$

9. If $\mathbf{A} = [a_{ij}]$ is an $n \times n$ matrix with a nonsingular determinant $|\mathbf{A}|$, then its **inverse** \mathbf{A}^{-1} , also called its **multiplicative inverse**, is given by

$$\mathbf{A}^{-1} = \frac{\text{adj } \mathbf{A}}{|\mathbf{A}|}, \quad \mathbf{A}^{-1}\mathbf{A} = \mathbf{A}\mathbf{A}^{-1} = \mathbf{I}.$$

10. The **trace** of an $n \times n$ matrix $\mathbf{A} = [a_{ij}]$, written $\text{tr } \mathbf{A}$, is defined to be the sum of the terms on the leading diagonal, so that

$$\text{tr } \mathbf{A} = a_{11} + a_{22} + \dots + a_{nn}.$$

11. The $n \times n$ matrix $\mathbf{A} = [a_{ij}]$ is **symmetric** if $a_{ij} = a_{ji}$ for $i, j = 1, 2, \dots, n$.
12. The $n \times n$ matrix $\mathbf{A} = [a_{ij}]$ is **skew-symmetric** if $a_{ij} = -a_{ji}$ for $i, j = 1, 2, \dots, n$; so in a skew-symmetric matrix each element on the leading diagonal is zero.
13. An $n \times n$ matrix $\mathbf{A} = [a_{ij}]$ is of **upper triangular type** if $a_{ij} = 0$ for $i > j$ and of **lower triangular type** if $a_{ij} = 0$ for $j > i$.
14. A real $n \times n$ matrix \mathbf{A} is orthogonal if, and only if, $\mathbf{A}\mathbf{A}^T = \mathbf{I}$.
15. If $\mathbf{A} = [a_{ij}]$ is an $n \times n$ matrix with complex elements, then its **Hermitian transpose** \mathbf{A}^\dagger is defined to be

$$\mathbf{A}^\dagger = [\bar{a}_{ji}],$$

with the bar denoting the complex conjugate operation. The Hermitian transpose operation is also denoted by a superscript H, so that $\mathbf{A}^\dagger = \mathbf{A}^H = (\bar{\mathbf{A}})^T$.

A Hermitian matrix \mathbf{A} is said to be **normal** if \mathbf{A} and \mathbf{A}^\dagger commute, so that $\mathbf{A}\mathbf{A}^\dagger = \mathbf{A}^\dagger\mathbf{A}$ or, in the equivalent notation, $\mathbf{A}\mathbf{A}^H = \mathbf{A}^H\mathbf{A}$.

16. An $n \times n$ matrix \mathbf{A} is Hermitian if $\mathbf{A} = \mathbf{A}^\dagger$, or equivalently, if $\mathbf{A} = \overline{\mathbf{A}}^T$, with the overbar denoting the complex conjugate operation.
17. An $n \times n$ matrix \mathbf{A} is **unitary** if $\mathbf{A}\mathbf{A}^\dagger = \mathbf{A}^\dagger\mathbf{A} = \mathbf{I}$.
18. If \mathbf{A} is an $n \times n$ matrix, the **eigenvectors** \mathbf{X} satisfy the equation

$$\mathbf{A}\mathbf{X} = \lambda\mathbf{X},$$

while the **eigenvalues** λ satisfy the characteristic equation

$$|\mathbf{A} - \lambda\mathbf{I}| = 0.$$

19. An $n \times n$ matrix \mathbf{A} is **nilpotent with index k** , if k is the smallest integer such that $\mathbf{A}^{k-1} \neq \mathbf{0}$ but $\mathbf{A}^k = \mathbf{0}$. For example, if

$$\mathbf{A} = \begin{bmatrix} 0 & 0 & 0 \\ 3 & 0 & 0 \\ 1 & 2 & 0 \end{bmatrix}, \quad \mathbf{A}^2 = \begin{bmatrix} 0 & 0 & 0 \\ 0 & 0 & 0 \\ 6 & 0 & 0 \end{bmatrix} \text{ and } \mathbf{A}^3 = \mathbf{0}, \text{ so } \mathbf{A} \text{ is nilpotent with index 3.}$$

20. An $n \times n$ matrix \mathbf{A} is **idempotent** if $\mathbf{A}^2 = \mathbf{A}$.
21. An $n \times n$ matrix \mathbf{A} is **positive definite** if $\mathbf{x}^T\mathbf{A}\mathbf{x} > 0$, for $\mathbf{x} \neq \mathbf{0}$ an n element column vector.
22. An $n \times n$ matrix \mathbf{A} is **nonnegative definite** if $\mathbf{x}^T\mathbf{A}\mathbf{x} \geq 0$, for $\mathbf{x} \neq \mathbf{0}$ an n element column vector.
23. An $n \times n$ matrix \mathbf{A} is **diagonally dominant** if $|a_{ii}| > \sum_{j \neq i} |a_{ij}|$ for all i .
24. Two matrices \mathbf{A} and \mathbf{B} are **equal** if, and only if, they are both of the same shape and corresponding elements are equal.
25. Two matrices \mathbf{A} and \mathbf{B} can be added (or subtracted) if, and only if, they have the same shape. If $\mathbf{A} = [a_{ij}]$, $\mathbf{B} = [b_{ij}]$, and $\mathbf{C} = \mathbf{A} + \mathbf{B}$, with $\mathbf{C} = [c_{ij}]$, then

$$c_{ij} = a_{ij} + b_{ij}.$$

Similarly, if $\mathbf{D} = \mathbf{A} - \mathbf{B}$, with $\mathbf{D} = [d_{ij}]$, then

$$d_{ij} = a_{ij} - b_{ij}.$$

26. If k is a scalar and $\mathbf{A} = [a_{ij}]$ is a matrix, then

$$k\mathbf{A} = [ka_{ij}].$$

27. If \mathbf{A} is an $m \times n$ matrix and \mathbf{B} is a $p \times q$ matrix, the matrix product $\mathbf{C} = \mathbf{A}\mathbf{B}$, in this order, is only defined if $n = p$, and then \mathbf{C} is an $m \times q$ matrix. When the matrix product

$\mathbf{C} = \mathbf{AB}$ is defined, the entry c_{ij} in the i 'th row and j 'th column of \mathbf{C} is $\mathbf{a}_i \mathbf{b}_j$, where \mathbf{a}_i is the i 'th row of \mathbf{A} , \mathbf{C}_j is the j 'th column of \mathbf{B} , and if

$$\mathbf{a}_i = [a_{i1}, a_{i2}, \dots, a_{in}], \quad \mathbf{b}_j = \begin{bmatrix} b_{1j} \\ b_{2j} \\ \vdots \\ b_{nj} \end{bmatrix},$$

then

$$\mathbf{a}_i \mathbf{b}_j = a_{i1}b_{1j} + a_{i2}b_{2j} + \dots + a_{in}b_{nj}.$$

Thus if

$$\mathbf{A} = \begin{bmatrix} 3 & -1 & 4 \\ 1 & 0 & 2 \end{bmatrix}, \quad \mathbf{B} = \begin{bmatrix} 1 & 2 \\ 0 & -3 \\ 2 & 1 \end{bmatrix}, \quad \text{and} \quad \mathbf{C} = \begin{bmatrix} 1 & 2 & 1 \\ 0 & 1 & 2 \\ 4 & -1 & 1 \end{bmatrix},$$

$$\mathbf{AB} = \begin{bmatrix} 11 & 13 \\ 5 & 4 \end{bmatrix}, \quad \mathbf{BA} = \begin{bmatrix} 5 & -1 & 8 \\ -3 & 0 & -6 \\ 2 & -2 & 10 \end{bmatrix}, \quad \mathbf{AC} = \begin{bmatrix} 19 & 1 & 5 \\ 9 & 0 & 3 \end{bmatrix}$$

but \mathbf{BC} is *not* defined.

28. Let the characteristic equation of the $n \times n$ matrix \mathbf{A} determined by $|\mathbf{A} - \lambda \mathbf{I}| = 0$ have the form

$$\lambda^n + c_1 \lambda^{n-1} + c_2 \lambda^{n-2} + \dots + c_n = 0.$$

Then \mathbf{A} satisfies its characteristic equation, so

$$\mathbf{A}^n + c_1 \mathbf{A}^{n-1} + c_2 \mathbf{A}^{n-2} + \dots + c_n \mathbf{I} = 0.$$

(Cayley–Hamilton theorem.)

29. If the matrix product \mathbf{AB} is defined, then

$$(\mathbf{AB})^T = \mathbf{B}^T \mathbf{A}^T.$$

30. If the matrix product \mathbf{AB} is defined, then

$$(\mathbf{AB})^{-1} = \mathbf{B}^{-1} \mathbf{A}^{-1}.$$

31. The matrix \mathbf{A} is **orthogonal** if $\mathbf{AA}^T = \mathbf{I}$.

32. An $n \times n$ matrix \mathbf{A} with distinct eigenvalues $\lambda_1, \lambda_2, \dots, \lambda_n$, and a corresponding set of linearly independent eigenvectors $\mathbf{x}_1, \mathbf{x}_2, \dots, \mathbf{x}_n$, satisfying $\mathbf{Ax}_i = \lambda_i \mathbf{x}_i$ for $i = 1, 2, \dots, n$, may always be transformed into the **diagonal** matrix $\mathbf{D} = \text{diag}\{\lambda_1, \lambda_2, \dots, \lambda_n\}$. This

is accomplished by setting $\mathbf{D} = \mathbf{P}^{-1}\mathbf{A}\mathbf{P}$, where \mathbf{P} is the matrix with its columns the eigenvectors $\mathbf{x}_1, \mathbf{x}_2, \dots, \mathbf{x}_n$ of \mathbf{A} arranged in the same order as that of the corresponding eigenvalues in \mathbf{D} . This result also applies if an eigenvalue λ_j is repeated r times $\lambda_j^{(1)}, \lambda_j^{(2)}, \dots, \lambda_j^{(r)}$, provided it has associated with it r linearly independent eigenvectors $\mathbf{x}_j^{(1)}, \mathbf{x}_j^{(2)}, \dots, \mathbf{x}_j^{(r)}$. This process is called the **diagonalization** of matrix \mathbf{A} . Diagonalization of a matrix is not possible if an eigenvalue that is repeated r times has fewer than r linearly independent eigenvectors.

Example The following is an example of diagonalization. If matrix

$$\mathbf{A} = \begin{bmatrix} 3 & -2 & 0 \\ 0 & 1 & 0 \\ 1 & -1 & 2 \end{bmatrix}, \text{ then } \lambda_1 = 1, \lambda_2 = 2, \lambda_3 = 3, \text{ and}$$

$$\mathbf{x}_1 = \begin{bmatrix} 1 \\ 1 \\ 0 \end{bmatrix}, \mathbf{x}_2 = \begin{bmatrix} 0 \\ 0 \\ 1 \end{bmatrix}, \mathbf{x}_3 = \begin{bmatrix} 1 \\ 0 \\ 1 \end{bmatrix}.$$

Then

$$\mathbf{P} = [\mathbf{x}_1, \mathbf{x}_2, \mathbf{x}_3] = \begin{bmatrix} 1 & 0 & 1 \\ 1 & 0 & 0 \\ 0 & 1 & 1 \end{bmatrix} \text{ and } \mathbf{P}^{-1} = \begin{bmatrix} 0 & 1 & 0 \\ -1 & 1 & 1 \\ 1 & -1 & 0 \end{bmatrix} \text{ so, as expected,}$$

$$\mathbf{D} = \mathbf{P}^{-1}\mathbf{A}\mathbf{P} = \begin{bmatrix} 1 & 0 & 0 \\ 0 & 2 & 0 \\ 0 & 0 & 3 \end{bmatrix} = \text{diag}\{\lambda_1, \lambda_2, \lambda_3\}.$$

Had the second and third columns of \mathbf{P} been interchanged, the result would become $\mathbf{D} = \mathbf{P}^{-1}\mathbf{A}\mathbf{P} = \text{diag}\{\lambda_1, \lambda_3, \lambda_2\}$, where now λ_2 and λ_3 are interchanged.

1.5.2 Quadratic Forms

1.5.2.1 Definitions

A **quadratic form** involving the n real variables x_1, x_2, \dots, x_n that are associated with the real $n \times n$ matrix $\mathbf{A} = [a_{ij}]$ is the scalar expression

$$1. \quad Q(x_1, x_2, \dots, x_n) = \sum_{i=1}^n \sum_{j=1}^n a_{ij} x_i x_j.$$

In matrix notation, if \mathbf{x} is the $n \times 1$ column vector with real elements x_1, x_2, \dots, x_n , and \mathbf{x}^T is the transpose of \mathbf{x} , then

$$2. \quad Q(\mathbf{x}) = \mathbf{x}^T \mathbf{A} \mathbf{x}.$$

Employing the **inner product** notation, this same quadratic form may also be written

3. $Q(\mathbf{x}) \equiv (\mathbf{x}, \mathbf{Ax})$.

If the $n \times n$ matrix \mathbf{A} is Hermitian, so that $\overline{\mathbf{A}}^T = \mathbf{A}$, where the bar denotes the complex conjugate operation, the quadratic form associated with the Hermitian matrix \mathbf{A} and the vector \mathbf{x} , which may have complex elements, is the real quadratic form

4. $Q(\mathbf{x}) = (\mathbf{x}, \mathbf{Ax})$.

It is always possible to express an arbitrary quadratic form

5. $Q(x) = \sum_{i=1}^n \sum_{j=1}^n \alpha_{ij} x_i x_j$

in the form

6. $Q(\mathbf{x}) = (\mathbf{x}, \mathbf{Ax})$,

in which $\mathbf{A} = [a_{ij}]$ is a symmetric matrix, by defining

7. $a_{ii} = \alpha_{ii}$ for $i = 1, 2, \dots, n$
and

8. $a_{ij} = \frac{1}{2}(\alpha_{ij} + \alpha_{ji})$ for $i, j = 1, 2, \dots, n$ and $i \neq j$.

9. When a quadratic form Q in n variables is reduced by a nonsingular linear transformation to the form

$$Q = y_1^2 + y_2^2 + \cdots + y_p^2 - y_{p+1}^2 - y_{p+2}^2 - \cdots - y_r^2,$$

the number p of positive squares appearing in the reduction is an invariant of the quadratic form Q , and does not depend on the method of reduction itself (**Sylvester's law of inertia**).

10. The **rank** of the quadratic form Q in the above canonical form is the total number r of squared terms (both positive and negative) appearing in its reduced form ($r \leq n$).
11. The **signature** of the quadratic form Q above is the number s of positive squared terms appearing in its reduced form. It is sometimes also defined to be $2s - r$.
12. The quadratic form $Q(\mathbf{x}) = (\mathbf{x}, \mathbf{Ax})$ is said to be **positive definite** when $Q(\mathbf{x}) > 0$ for $\mathbf{x} \neq 0$. It is said to be **positive semidefinite** if $Q(\mathbf{x}) \geq 0$ for $\mathbf{x} \neq 0$.

1.5.2.2 Basic Theorems on Quadratic Forms

1. Two real quadratic forms are **equivalent** under the group of linear transformations if, and only if, they have the same rank and the same signature.
2. A real quadratic form in n variables is positive definite if, and only if, its canonical form is

$$Q = z_1^2 + z_2^2 + \cdots + z_n^2.$$

3. A real symmetric matrix \mathbf{A} is positive definite if, and only if, there exists a real nonsingular matrix \mathbf{M} such that $\mathbf{A} = \mathbf{MM}^T$.
4. Any real quadratic form in n variables may be reduced to the diagonal form

$$Q = \lambda_1 z_1^2 + \lambda_2 z_2^2 + \cdots + \lambda_n z_n^2, \quad \lambda_1 \geq \lambda_2 \geq \cdots \geq \lambda_n$$

by a suitable orthogonal point-transformation. See 32 in Section 1.5.1 for the **diagonalization** of a matrix.

5. The quadratic form $Q = (\mathbf{x}, \mathbf{Ax})$ is positive definite if, and only if, every eigenvalue of \mathbf{A} is positive; it is positive semidefinite if, and only if, all the eigenvalues of \mathbf{A} are nonnegative; and it is indefinite if the eigenvalues of \mathbf{A} are of both signs.
6. The necessary conditions for a Hermitian matrix \mathbf{A} to be positive definite are
 - (i) $a_{ii} > 0$ for all i ,
 - (ii) $a_{ii}a_{ij} > |a_{ij}|^2$ for $i \neq j$,
 - (iii) the element of largest modulus must lie on the leading diagonal,
 - (iv) $|\mathbf{A}| > 0$.
7. The quadratic form $Q = (\mathbf{x}, \mathbf{Ax})$ with \mathbf{A} Hermitian will be positive definite if all the principal minors in the top left-hand corner of \mathbf{A} are positive, so that

$$a_{11} > 0, \quad \begin{vmatrix} a_{11} & a_{12} \\ a_{21} & a_{22} \end{vmatrix} > 0, \quad \begin{vmatrix} a_{11} & a_{12} & a_{13} \\ a_{21} & a_{22} & a_{23} \\ a_{31} & a_{32} & a_{33} \end{vmatrix} > 0, \quad \dots$$

8. Let $\lambda_1, \lambda_2, \dots, \lambda_n$ be the eigenvalues (they are real) of the $n \times n$ real symmetric matrix \mathbf{A} associated with a real quadratic form $Q(\mathbf{x})$, and let $\mathbf{x}_1, \mathbf{x}_2, \dots, \mathbf{x}_n$ be the corresponding normalized eigenvectors. Then if $\mathbf{P} = [\mathbf{x}_1, \mathbf{x}_2, \dots, \mathbf{x}_n]$ is the $n \times n$ orthogonal matrix with \mathbf{x}_i as its i th column, the matrix $\mathbf{D} = \mathbf{P}^{-1}\mathbf{AP}$ is a diagonal matrix with $\lambda_1, \lambda_2, \dots, \lambda_n$ as the elements on its leading diagonal.

The change of variable $\mathbf{x} = \mathbf{P}\mathbf{y}$, with $\mathbf{y} = [y_1, y_2, \dots, y_n]^T$ transforms $Q(\mathbf{x})$ into the standard form

$$Q(\mathbf{x}) = \lambda_1 y_1^2 + \lambda_2 y_2^2 + \dots + \lambda_n y_n^2.$$

Setting $\lambda_{\min} = \min\{\lambda_1, \lambda_2, \dots, \lambda_n\}$ and $\lambda_{\max} = \max\{\lambda_1, \lambda_2, \dots, \lambda_n\}$ it follows directly that

$$\lambda_{\min} \mathbf{y}^T \mathbf{y} \leq Q(\mathbf{x}) \leq \lambda_{\max} \mathbf{y}^T \mathbf{y}.$$

1.5.3 Differentiation and Integration of Matrices

1.5.3.1

If the $n \times n$ matrices $\mathbf{A}(t)$ and $\mathbf{B}(t)$ have elements that are differentiable function of t , so that

$$\mathbf{A}(t) = [a_{ij}(t)], \quad \mathbf{B}(t) = [b_{ij}(t)],$$

then

1. $\frac{d}{dt} \mathbf{A}(t) = \left[\frac{d}{dt} a_{ij}(t) \right]$
2. $\frac{d}{dt} [\mathbf{A}(t) \pm \mathbf{B}(t)] = \left[\frac{d}{dt} a_{ij}(t) \pm \frac{d}{dt} b_{ij}(t) \right] = \frac{d}{dt} \mathbf{A}(t) \pm \frac{d}{dt} \mathbf{B}(t).$

3. If the matrix product $\mathbf{A}(t)\mathbf{B}(t)$ is defined, then

$$\frac{d}{dt} [\mathbf{A}(t)\mathbf{B}(t)] = \left[\frac{d}{dt} \mathbf{A}(t) \right] \mathbf{B}(t) + \mathbf{A}(t) \frac{d}{dt} \mathbf{B}(t).$$

4. If the matrix product $\mathbf{A}(t)\mathbf{B}(t)$ is defined, then

$$\frac{d}{dt} [\mathbf{A}(t)\mathbf{B}(t)]^T = \left[\frac{d}{dt} \mathbf{B}(t) \right]^T \mathbf{A}^T(t) + \mathbf{B}^T(t) \left(\frac{d}{dt} \mathbf{A}(t) \right)^T.$$

5. If the square matrix \mathbf{A} is nonsingular, so that $|\mathbf{A}| \neq 0$, then

$$\frac{d}{dt} [\mathbf{A}]^{-1} = -\mathbf{A}^{-1}(t) \left[\frac{d}{dt} \mathbf{A}(t) \right] \mathbf{A}^{-1}(t).$$

6.
$$\int_{t_0}^t \mathbf{A}(\tau) d\tau = \left[\int_{t_0}^t a_{ij}(\tau) d\tau \right].$$

1.5.4 The Matrix Exponential

1.5.4.1 Definition

If \mathbf{A} is a square matrix, and z is any complex number, then the matrix exponential $e^{\mathbf{A}z}$ is defined to be

$$e^{\mathbf{A}z} = \mathbf{I} + \mathbf{A}z + \cdots + \frac{\mathbf{A}^n z^n}{n!} + \cdots = \sum_{r=0}^{\infty} \frac{1}{r!} \mathbf{A}^r z^r.$$

1.5.4.2 Basic Properties of the Matrix Exponential

1. $e^0 = \mathbf{I}$, $e^{\mathbf{I}z} = \mathbf{I}e^z$, $e^{\mathbf{A}(z_1+z_2)} = e^{\mathbf{A}z_1} \cdot e^{\mathbf{A}z_2}$, $e^{-\mathbf{A}z} = (e^{\mathbf{A}z})^{-1}$, $e^{\mathbf{A}z} \cdot e^{\mathbf{B}z} = e^{(\mathbf{A}+\mathbf{B})z}$

when $\mathbf{A} + \mathbf{B}$ is defined and $\mathbf{AB} = \mathbf{BA}$.

2. $\frac{d^r}{dz^r} (e^{\mathbf{A}z}) = \mathbf{A}^r e^{\mathbf{A}z} = e^{\mathbf{A}z} \mathbf{A}^r$.

3. If the square matrix \mathbf{A} can be expressed in the form

$$\mathbf{A} = \begin{bmatrix} \mathbf{B} & 0 \\ 0 & \mathbf{C} \end{bmatrix},$$

with \mathbf{B} and \mathbf{C} square matrices, then

$$e^{\mathbf{A}z} = \begin{bmatrix} e^{\mathbf{B}z} & 0 \\ 0 & e^{\mathbf{C}z} \end{bmatrix}.$$

1.5.4.3 Computation of the Matrix Exponential

When \mathbf{A} is an $n \times n$ matrix with the n distinct eigenvalues $\lambda_1, \lambda_2, \dots, \lambda_n$, the computation of $e^{\mathbf{A}z}$ is only straightforward if $\mathbf{A} = \text{diag}\{\lambda_1, \lambda_2, \dots, \lambda_n\}$ or \mathbf{A} is nilpotent with index k (see 1.5.1.1, 19). In the first case, the definition of $e^{\mathbf{A}z}$ in 1.5.4.1 shows that $e^{\mathbf{A}z} = \text{diag}\{e^{\lambda_1 z}, e^{\lambda_2 z}, \dots, e^{\lambda_n z}\}$. In the second case, the sum of matrices in the definition of $e^{\mathbf{A}}$ in 1.5.4.1 is finite because its last non-zero term is $\mathbf{A}^{k-1} z^{k-1} / (k-1)!$.

If neither of the above methods is applicable, but an $n \times n$ matrix \mathbf{A} can be diagonalized to give $\mathbf{D} = \mathbf{P}^{-1} \mathbf{A} \mathbf{P}$ (see 1.5.1.1, 32), $e^{\mathbf{A}z}$ follows from the result $e^{\mathbf{A}z} = \mathbf{P} e^{\mathbf{P}^{-1} \mathbf{A} \mathbf{P} z} \mathbf{P}^{-1} = \mathbf{P} e^{\mathbf{D}z} \mathbf{P}^{-1}$.

Example The matrix $\mathbf{A} = \begin{bmatrix} 2 & -3 & -3 \\ 0 & 1 & 0 \\ 0 & -2 & -1 \end{bmatrix}$ can be diagonalized because its eigenvalues are $\lambda_1 = -1$, $\lambda_2 = 1$, and $\lambda_3 = 2$, and the corresponding eigenvectors are

$$\mathbf{x}_1 = \begin{bmatrix} 1 \\ 0 \\ 1 \end{bmatrix}, \mathbf{x}_2 = \begin{bmatrix} 0 \\ 1 \\ -1 \end{bmatrix} \text{ and } \mathbf{x}_3 = \begin{bmatrix} 1 \\ 0 \\ 0 \end{bmatrix}, \text{ so } \mathbf{P} = \begin{bmatrix} 1 & 0 & 1 \\ 0 & 1 & 0 \\ 1 & -1 & 0 \end{bmatrix} \text{ and}$$

$$\mathbf{P}^{-1} = \begin{bmatrix} 0 & 1 & 1 \\ 0 & 1 & 0 \\ 1 & -1 & -1 \end{bmatrix}.$$

The matrix \mathbf{D} can be written down immediately because the eigenvalues of \mathbf{A} are known, so that

$$\mathbf{D} = \begin{bmatrix} -1 & 0 & 0 \\ 0 & 1 & 0 \\ 0 & 0 & 2 \end{bmatrix}, \text{ and } \mathbf{D}z = \begin{bmatrix} -z & 0 & 0 \\ 0 & z & 0 \\ 0 & 0 & 2z \end{bmatrix}, \text{ hence } e^{\mathbf{D}z} = \begin{bmatrix} e^{-z} & 0 & 0 \\ 0 & e^z & 0 \\ 0 & 0 & e^{2z} \end{bmatrix}.$$

$$\text{As } \mathbf{D}z = \mathbf{P}^{-1} \mathbf{A} \mathbf{P} z = \begin{bmatrix} -z & 0 & 0 \\ 0 & z & 0 \\ 0 & 0 & 2z \end{bmatrix}, \text{ it follows that } e^{\mathbf{D}z} = \begin{bmatrix} e^{-z} & 0 & 0 \\ 0 & e^z & 0 \\ 0 & 0 & e^{2z} \end{bmatrix},$$

$$\text{and so } e^{\mathbf{A}z} = \mathbf{P} e^{\mathbf{D}z} \mathbf{P}^{-1} = \begin{bmatrix} e^{2z} & e^{-z} - e^{2z} & e^{-z} - e^{2z} \\ 0 & e^z & 0 \\ 0 & e^{-z} - e^z & e^{-z} \end{bmatrix}.$$

The matrix exponential $e^{\mathbf{A}z}$ can also be found from the result $e^{\mathbf{A}z} = \mathcal{L}^{-1}\{[s\mathbf{I} - \mathbf{A}]^{-1}\}$, irrespective of whether or not \mathbf{A} is diagonalizable. Here \mathcal{L}^{-1} denotes the inverse Laplace transform, z is the original untransformed variable, and s is the Laplace transform variable. When n is large, this method is computationally intensive, so it is only useful when n is small.

Example The matrix $\mathbf{A} = \begin{bmatrix} 3 & 1 \\ 0 & 3 \end{bmatrix}$ is not diagonalizable, and $n = 2$, so it is appropriate to use the inverse Laplace transform method to find $e^{\mathbf{A}z}$. We have $[s\mathbf{I} - \mathbf{A}] = \begin{bmatrix} s-3 & 1 \\ 0 & s-3 \end{bmatrix}$, so $[s\mathbf{I} - \mathbf{A}]^{-1} = \begin{bmatrix} 1/(s-3) & 1/(s-3)^2 \\ 0 & 1/(s-3) \end{bmatrix}$.

Taking the inverse Laplace transform of each element of the matrix to transform back from the Laplace transform variable s to the original variable z gives

$$e^{\mathbf{A}z} = \mathcal{L}^{-1}\{[s\mathbf{I} - \mathbf{A}]^{-1}\} = \begin{bmatrix} e^{3z} & ze^{3z} \\ 0 & e^{3z} \end{bmatrix}.$$

1.5.5 The Gerschgorin Circle Theorem

1.5.5.1 The Gerschgorin Circle Theorem

Each eigenvalue of an arbitrary $n \times n$ matrix $\mathbf{A} = [a_{ij}]$ lies in at least one of the circles C_1, C_2, \dots, C_n in the complex plane, where the circle C_r with radius ρ_r has its center at a_{rr} , where a_{rr} is the r 'th element of the leading diagonal of \mathbf{A} , and

$$\rho_r = \sum_{\substack{j=1 \\ j \neq r}}^n |a_{rj}| = |a_{r1}| + |a_{r2}| + \dots + |a_{r,r-1}| + |a_{r,r+1}| + \dots + |a_{rn}|.$$

1.6 PERMUTATIONS AND COMBINATIONS

1.6.1 Permutations

1.6.1.1

1. A **permutation** of n mutually distinguishable elements is an arrangement or sequence of occurrence of the elements in which their *order* of appearance counts.
2. The number of possible mutually distinguishable permutations of n distinct elements is denoted either by ${}^n P_n$ or by $n P_n$, where

$${}^n P_n = n(n-1)(n-2) \cdots 3 \cdot 2 \cdot 1 = n!$$

3. The number of possible mutually distinguishable permutations of n distinct elements m at a time is denoted either by ${}^n P_m$ or by $n P_m$, where

$${}^n P_m = \frac{n!}{(n-m)!} \quad [0! \equiv 1].$$

4. The number of possible identifiably different permutations of n elements of two different types, of which m are of type 1 and $n-m$ are of type 2 is

$$\frac{n!}{m!(n-m)!} = \binom{n}{m}. \quad (\text{binomial coefficient})$$

This gives the relationship between binomial coefficients and the number of m element subsets of an n set. Expressed differently, this says that the coefficient of x^m in $(1+x)^n$ is the number of ways x 's can be selected from precisely m of the n factors of the n -fold product being expanded.

5. The number of possible identifiably different permutations of n elements of m different types, in which m_r are of type r , with $m_1 + m_2 + \cdots + m_r = n$, is

$$\frac{n!}{m_1!m_2! \cdots m_r!}. \quad (\text{multinomial coefficient})$$

1.6.2 Combinations

1.6.2.1

1. A **combination** of n mutually distinguishable elements m at a time is a selection of m elements from the n *without regard to their order* of arrangement. The number of such combinations is denoted either by nC_m or by ${}_nC_m$, where

$${}^nC_m = \binom{n}{m}.$$

2. The number of combinations of n mutually distinguishable elements in which each element may occur 0, 1, 2, \dots , m times in any combination is

$$\binom{n+m-1}{m} = \binom{n+n-1}{n-1}.$$

3. The number of combinations of n mutually distinguishable elements in which each element must occur at least once in each combination is

$$\binom{m-1}{n-1}.$$

4. The number of distinguishable samples of m elements taken from n different elements, when each element may occur at most once in a sample, is

$$n(n-1)(n-2) \cdots (n-m+1).$$

5. The number of distinguishable samples of m elements taken from n different elements, when each element may occur 0, 1, 2, \dots , m times in a sample is n^m .

1.7 PARTIAL FRACTION DECOMPOSITION

1.7.1 Rational Functions

1.7.1.1

A function $R(x)$ of the form

1. $R(x) = \frac{N(x)}{D(x)},$

where $N(x)$ and $D(x)$ are polynomials in x , is called a **rational function** of x . The replacement of $R(x)$ by an equivalent expression involving a sum of simpler rational functions is called a decomposition of $R(x)$ into **partial fractions**. This technique is of use in the integration of arbitrary rational functions. Thus in the identity

$$\frac{3x^2 + 2x + 1}{x^3 + x^2 + x} = \frac{1}{x} + \frac{2x + 1}{x^2 + x + 1},$$

the expression on the right-hand side is a partial fraction expansion of the rational function $(3x^2 + 2x + 1)/(x^3 + x^2 + x)$.

1.7.2 Method of Undetermined Coefficients

1.7.2.1

1. The general form of the simplest possible partial fraction expansion of $R(x)$ in 1.7.1.1 depends on the respective degrees of $N(x)$ and $D(x)$, and on the decomposition of $D(x)$ into *real* factors. The form of the partial fraction decomposition to be adopted is determined as follows.

2. *Case 1.* (Degree of $N(x)$ less than the degree of $D(x)$).

(i) Let the degree of $N(x)$ be less than the degree of $D(x)$, and factor $D(x)$ into the simplest possible set of *real* factors. There may be linear factors with multiplicity 1, such as $(ax + b)$; linear factors with multiplicity r , such as $(ax + b)^r$; quadratic factors with multiplicity 1, such as $(ax^2 + bx + c)$; or quadratic factors with multiplicity m such as $(ax^2 + bx + c)^m$, where a, b, \dots , are real numbers, and the quadratic factors cannot be expressed as the product of *real* linear factors.

(ii) To each linear factor with multiplicity 1, such as $(ax + b)$, include in the partial fraction decomposition a term such as

$$\frac{A}{ax + b},$$

where A is an undetermined constant.

(iii) To each linear factor with multiplicity r , such as $(ax + b)^r$, include in the partial fraction decomposition terms such as

$$\frac{B_1}{ax + b} + \frac{B_2}{(ax + b)^2} + \cdots + \frac{B_r}{(ax + b)^r},$$

where B_1, B_2, \dots, B_r are undetermined constants.

(iv) To each quadratic factor with multiplicity 1, such as $(ax^2 + bx + c)$, include in the partial fraction decomposition a term such as

$$\frac{C_1x + D_1}{ax^2 + bx + c},$$

where C_1, D_1 are undetermined constants.

- (v) To each quadratic factor with multiplicity m , such as $(ax^2 + bx + c)^m$, include in the partial fraction decomposition terms such as

$$\frac{E_1x + F_1}{ax^2 + bx + c} + \frac{E_2x + F_2}{(ax^2 + bx + c)^2} + \cdots + \frac{E_mx + F_m}{(ax^2 + bx + c)^m},$$

where $E_1, D_1, \dots, E_m, F_m$ are undetermined constants.

- (vi) The final general form of the partial fraction decomposition of $R(x)$ in 1.7.1.1.1 is then the sum of all the terms generated in (ii) to (vi) containing the **undetermined coefficients** $A, B_1, B_2, \dots, E_m, F_m$.
- (vii) The specific values of the undetermined coefficients $A_1, B_1, \dots, E_m, F_m$ are determined by equating $N(x)/D(x)$ to the sum of terms obtained in (vi), multiplying this identity by the factored form of $D(x)$, and equating the coefficients of corresponding powers of x on each side of the identity. If, say, there are N undetermined coefficients, an alternative to deriving N equations satisfied by them by equating coefficients of corresponding powers of x is to obtain N equations by substituting N convenient different values for x .
3. *Case 2.* (Degree of $N(x)$ greater than or equal to degree of $D(x)$).
- (i) If the degree m of $N(x)$ is greater than or equal to the degree n of $D(x)$, first use long division to divide $D(x)$ into $N(x)$ to obtain an expression of the form

$$\frac{N(x)}{D(x)} = P(x) + \frac{M(x)}{D(x)},$$

where $P(x)$ is a known polynomial of degree $m - n$, the degree of $M(x)$ is less than the degree of $D(x)$.

- (ii) Decompose $M(x)/D(x)$ into partial fractions as in Case 1.
- (iii) The required partial fraction decomposition is then the sum of $P(x)$ and the terms obtained in (ii) above.

An example of Case 1 is provided by considering the following rational function and applying the above rules to the factors x and $(x^2 + x + 1)$ of the denominator to obtain

$$\frac{3x^2 + 2x + 1}{x^3 + x^2 + x} = \frac{3x^2 + 2x + 1}{x(x^2 + x + 1)} = \frac{A}{x} + \frac{Bx + C}{x^2 + x + 1}.$$

Multiplication by $x(x^2 + x + 1)$ yields

$$3x^2 + 2x + 1 = A(x^2 + x + 1) + x(Bx + C).$$

Equating coefficients of corresponding powers of x gives

$$\begin{aligned} 1 &= A && \text{(coefficients of } x^0) \\ 2 &= A + C && \text{(coefficients of } x) \\ 3 &= A + B && \text{(coefficients of } x^2) \end{aligned}$$

so $A = 1$, $B = 2$, $C = 1$, and the required partial fraction decomposition becomes

$$\frac{3x^2 + 2x + 1}{x^3 + x^2 + x} = \frac{1}{x} + \frac{2x + 1}{x^2 + x + 1}.$$

An example of Case 2 is provided by considering $(2x^3 + 5x^2 + 7x + 5)/(x + 1)^2$. The degree of the numerator exceeds that of the denominator, so division by $(x + 1)^2$ is necessary. We have

$$\begin{array}{r} 2x + 1 \\ x^2 + 2x + 1 \overline{) 2x^3 + 5x^2 + 7x + 5} \\ \underline{2x^3 + 4x^2 + 2x} \\ x^2 + 5x + 5 \\ \underline{x^2 + 2x + 1} \\ 3x + 4 \end{array}$$

and so

$$\frac{2x^3 + 5x^2 + 7x + 5}{(x + 1)^2} = 1 + 2x + \frac{3x + 4}{(x + 1)^2}.$$

An application of the rules of Case 1 to the rational function $(3x + 4)/(x + 1)^2$ gives

$$\frac{3x + 4}{(x + 1)^2} = \frac{A}{x + 1} + \frac{B}{(x + 1)^2},$$

or

$$3x + 4 = A(x + 1) + B.$$

Equating coefficients of corresponding powers of x gives

$$\begin{array}{ll} 4 = A + B & \text{(coefficients of } x^0\text{)} \\ 3 = A & \text{(coefficients of } x\text{)} \end{array}$$

so $A = 3$, $B = 1$ and the required partial fraction decomposition becomes

$$\frac{2x^3 + 5x^2 + 7x + 5}{(x + 1)^2} = 1 + 2x + \frac{3}{x + 1} + \frac{1}{(x + 1)^2}.$$

1.8 CONVERGENCE OF SERIES

1.8.1 Types of Convergence of Numerical Series

1.8.1.1

Let $\{u_k\}$ with $k = 1, 2, \dots$, be an infinite sequence of numbers, then the **infinite** numerical series

$$1. \quad \sum_{k=1}^{\infty} u_k = u_1 + u_2 + u_3 + \dots$$

is said to **converge** to the sum S if the sequence $\{S_n\}$ of **partial** sums

$$2. \quad S_n = \sum_{k=1}^n u_k = u_1 + u_2 + \dots + u_n \text{ has a finite limit } S, \text{ so that}$$

$$3. \quad S = \lim_{n \rightarrow \infty} S_n.$$

If S is infinite, or the sequence $\{S_n\}$ has no limit, the series 1.8.1.1.1 is said to **diverge**.

4. The series 1.8.1.1.1 is convergent if for each $\varepsilon > 0$ there is a number $N(\varepsilon)$ such that

$$|S_m - S_n| < \varepsilon \quad \text{for all } m > n > N.$$

(**Cauchy criterion for convergence**)

5. The series 1.8.1.1.1 is said to be **absolutely convergent** if the series of absolute values

$$\sum_{k=1}^n |u_k| = |u_1| + |u_2| + |u_3| + \dots$$

converges. Every absolutely convergent series is convergent. If series 1.8.1.1.1 is such that it is convergent, but it is not absolutely convergent, it is said to be **conditionally convergent**.

1.8.2 Convergence Tests

1.8.2.1

Let the series 1.8.1.1.1 be such that $u_k \neq 0$ for any k and

$$1. \quad \lim_{k \rightarrow \infty} \left| \frac{u_{k+1}}{u_k} \right| = r.$$

Then series 1.8.1.1.1 is absolutely convergent if $r < 1$ and it **diverges** if $r > 1$. The test fails to provide information about convergence or divergence if $r = 1$.

(**d'Alembert's ratio test**)

1.8.2.2

Let the series 1.8.1.1.1 be such that $u_k \neq 0$ for any k and

$$1. \quad \lim_{k \rightarrow \infty} |u_k|^{1/k} = r.$$

The series 1.8.1.1.1 is absolutely convergent if $r < 1$ and it diverges if $r > 1$. The test fails to provide information about convergence or divergence if $r = 1$.

(Cauchy's n 'th root test)

1.8.2.3

Let the series $\sum_{k=1}^{\infty} u_k$ be such that

$$\lim_{k \rightarrow \infty} k \left\{ \left| \frac{u_k}{u_{k+1}} \right| - 1 \right\} = r.$$

Then the series is absolutely convergent if $r > 1$ and it is divergent if $r < 1$. The test fails to provide information about convergence or divergence if $r = 1$. (**Raabe's test:** This test is a more delicate form of ratio test and it is often useful when the ratio test fails because $r = 1$.)

1.8.2.4

Let the series in 1.8.1.1.1 be such that $u_k \geq 0$ for $k = 1, 2, \dots$, and let $\sum_{k=1}^{\infty} a_k$ be a convergent series of positive terms such that $u_k \leq a_k$ for all k . Then

1. $\sum_{k=1}^{\infty} u_k$ is convergent and

$$\sum_{k=1}^{\infty} u_k \leq \sum_{k=1}^{\infty} a_k \quad (\text{comparison test for convergence})$$

2. If $\sum_{k=1}^{\infty} a_k$ is a divergent series of nonnegative terms and $u_k \geq a_k$ for all k , then $\sum_{k=1}^{\infty} u_k$ is divergent. (comparison test for divergence)

1.8.2.5

Let $\sum_{k=1}^{\infty} u_k$ be a series of positive terms whose convergence is to be determined, and let $\sum_{k=1}^{\infty} a_k$ be a comparison series of positive terms known to be either convergent or divergent. Let

1. $\lim_{k \rightarrow \infty} \frac{u_k}{a_k} = L,$

where L is either a nonnegative number or infinity.

2. If $\sum_{k=1}^{\infty} a_k$ converges and $0 \leq L < \infty$, $\sum_{k=1}^{\infty} u_k$ converges.
3. If $\sum_{k=1}^{\infty} a_k$ diverges and $0 < L \leq \infty$, $\sum_{k=1}^{\infty} u_k$ diverges. (limit comparison test)

1.8.2.6

Let $\sum_{k=1}^{\infty} u_k$ be a series of positive nonincreasing terms, and let $f(x)$ be a nonincreasing function defined for $k \geq N$ such that

1. $f(k) = u_k$.

Then the series $\sum_{k=1}^{\infty} u_k$ converges or diverges according as the improper integral

2. $\int_N^{\infty} f(x) dx$

converges or diverges.

(Cauchy integral test)

1.8.2.7

Let the sequence $\{a_k\}$ with $a_k > a_{k+1} > 0$, for $n = 1, 2, \dots$, be such that

1. $\lim_{k \rightarrow \infty} a_k = 0$.

Then the **alternating series** $\sum_{k=1}^{\infty} (-1)^{k+1} a_k$ converges, and

2. $|S - S_N| \leq a_{N+1}$,
where

$$S_N = a_1 - a_2 + a_3 - \dots + (-1)^{N+1} a_N.$$

1.8.2.8

If the series

1. $\sum_{k=1}^{\infty} v_k = v_1 + v_2 + \dots$

converges and the sequence of numbers $\{u_k\}$ forms a monotonic bounded sequence, that is, if $|u_k| < M$ for some number M and all k , the series

2. $\sum_{k=1}^{\infty} u_k v_k = u_1 v_1 + u_2 v_2 + \dots$

converges.

(Abel's test)

1.8.2.9

If the partial sums of the series 1.8.2.8.1 are bounded and if the numbers u_k constitute a monotonic decreasing sequence with limit zero, that is if

$$\left| \sum_{k=1}^n u_k \right| < M \quad [n = 1, 2, \dots] \quad \text{and} \quad \lim_{k \rightarrow \infty} u_k = 0,$$

then the series 1.8.2.8.1 converges.

(Dirichlet's test)

1.8.3 Examples of Infinite Numerical Series

1.8.3.1 Geometric and Arithmetic-Geometric Series

1. $\sum_{k=0}^{\infty} ar^k = \frac{a}{1-r} \quad [|r| < 1].$

(see 1.2.2.2)

$$2. \sum_{k=0}^{\infty} (a + kd)r^k = \frac{a}{1-r} + \frac{rd}{(1-r)^2} \quad [|r| < 1]. \quad (\text{see 1.2.2.3})$$

1.8.3.2 Binomial Expansion

$$1. \quad (1+a)^q = 1 + qa + \frac{q(q-1)}{2!}a^2 + \frac{q(q-1)(q-2)}{3!}a^3 + \dots$$

$$+ \frac{q(q-1)(q-2)\cdots(q-r+1)}{r!}a^r + \dots \quad [\text{any real } q, |a| < 1].$$

$$2. \quad (a+b)^q = a^q \left(1 + \frac{b}{a}\right)^q$$

$$= a^q \left[1 + q\left(\frac{b}{a}\right) + \frac{q(q-1)}{2!}\left(\frac{b}{a}\right)^2 + \frac{q(q-1)(q-2)}{3!}\left(\frac{b}{a}\right)^3 + \dots \right.$$

$$\left. + \frac{q(q-1)(q-2)\cdots(q-r+1)}{r!}\left(\frac{b}{a}\right)^r + \dots \right] \quad [\text{any real } q, |b/a| < 1]. \quad (\text{see 0.7.5})$$

1.8.3.3 Series with Rational Sums

$$1. \quad \sum_{k=1}^{\infty} \frac{1}{k(k+1)} = 1$$

$$2. \quad \sum_{k=1}^{\infty} \frac{1}{k(k+2)} = \frac{3}{4}$$

$$3. \quad \sum_{k=1}^{\infty} \frac{1}{(2k-1)(2k+1)} = \frac{1}{2}$$

$$4. \quad \sum_{k=1}^{\infty} \frac{k}{(4k^2-1)^2} = \frac{1}{8}$$

$$5. \quad \sum_{k=1}^{\infty} \frac{k}{(k+1)!} = 1$$

1.8.3.4 Series Involving π

$$1. \quad \sum_{k=1}^{\infty} (-1)^{k+1} \frac{1}{(2k-1)} = \frac{\pi}{4}$$

$$2. \quad \sum_{k=1}^{\infty} \frac{1}{k^2} = \frac{\pi^2}{6}$$

$$3. \quad \sum_{k=1}^{\infty} (-1)^{k+1} \frac{1}{k^2} = \frac{\pi^2}{12}$$

$$4. \sum_{k=1}^{\infty} \frac{(-1)^{k+1}}{(2k-1)^3} = \frac{\pi^3}{32}$$

$$5. \sum_{k=1}^{\infty} \frac{1}{(2k-1)^4} = \frac{\pi^4}{96}$$

$$6. \sum_{k=1}^{\infty} \frac{1}{(4k-1)(4k+1)} = \frac{1}{2} - \frac{\pi}{8}$$

1.8.3.5 Series Involving e

$$1. \sum_{k=0}^{\infty} \frac{1}{k!} = e = 2.71828\dots$$

$$2. \sum_{k=0}^{\infty} \frac{(-1)^k}{k!} = \frac{1}{e} = 0.36787\dots$$

$$3. \sum_{k=1}^{\infty} \frac{2k}{(2k+1)!} = \frac{1}{e} = 0.36787\dots$$

$$4. \sum_{k=0}^{\infty} \frac{1}{(2k)!} = \frac{1}{2} \left(e + \frac{1}{e} \right) = 1.54308\dots$$

$$5. \sum_{k=0}^{\infty} \frac{1}{(2k+1)!} = \frac{1}{2} \left(e - \frac{1}{e} \right) = 1.17520\dots$$

1.8.3.6 Series Involving a Logarithm

$$1. \sum_{k=0}^{\infty} (-1)^{k+1} \frac{1}{k} = \ln 2$$

$$2. \sum_{k=1}^{\infty} (-1)^{k+1} \frac{1}{k \cdot m^k} = \ln \left(\frac{1+m}{m} \right) \quad [m = 1, 2, \dots]$$

$$3. \sum_{k=1}^{\infty} \frac{1}{k(4k^2-1)} = 2 \ln 2 - 1$$

$$4. \sum_{k=1}^{\infty} \frac{1}{k(9k^2-1)} = \frac{3}{2} (\ln 3 - 1)$$

$$5. \sum_{k=1}^{\infty} \frac{1}{k(4k^2-1)^2} = \frac{3}{2} - 2 \ln 2$$

$$6. \sum_{k=1}^{\infty} \frac{12k^2-1}{k(4k^2-1)^2} = 2 \ln 2$$

7.
$$\sum_{k=1}^{\infty} \frac{1}{(2k-1)k(2k+1)} = 2 \ln 2 - 1$$
8.
$$\sum_{k=1}^{\infty} \frac{(-1)^{k+1}}{(2k-1)k(2k+1)} = (1 - \ln 2)$$
9.
$$\sum_{k=1}^{\infty} \frac{1}{2^k k} = \ln 2$$

1.8.3.7 Series and Identities Involving the Gamma Function

1.
$$\sqrt{\pi} \ln 4 = \sum_{n=1}^{\infty} \frac{\Gamma(n + \frac{1}{2})}{n^2 \Gamma(n)}$$
2.
$$\frac{1 \cdot 3 \cdot 5 \cdots (2m-1)}{2^m} \sqrt{\pi} = \Gamma(m + \frac{1}{2}), \quad m = 1, 2, 3, \dots$$
3.
$$\frac{(-1)^m 2^m}{1 \cdot 3 \cdot 5 \cdots (2m-1)} \sqrt{\pi} = \Gamma(-m + \frac{1}{2}), \quad m = 1, 2, 3, \dots$$

1.9 INFINITE PRODUCTS

1.9.1 Convergence of Infinite Products

1.9.1.1

Let $\{u_k\}$ be an infinite sequence of numbers and denote the product of the first n elements of the sequence by $\prod_{k=1}^n u_k$, so that

1.
$$\prod_{k=1}^n u_k = u_1 u_2 \cdots u_n.$$

Then if the limit $\lim_{n \rightarrow \infty} \prod_{k=1}^n u_k$ exists, whether finite or infinite, but of definite sign, this limit is called the value of the **infinite product** $\prod_{k=1}^{\infty} u_k$, and we write

2.
$$\lim_{n \rightarrow \infty} \prod_{k=1}^n u_k = \prod_{k=1}^{\infty} u_k.$$

If an infinite product has a finite *nonzero* value it is said to **converge**. An infinite product that does not converge is said to **diverge**.

1.9.1.2

If $\{a_k\}$ is an infinite sequence of numbers, in order that the infinite product

1.
$$\prod_{k=1}^{\infty} (1 + a_k)$$

should converge it is necessary that $\lim_{n \rightarrow \infty} a_k = 0$.

1.9.1.3

If $a_k > 0$ or $a_k < 0$ for all k starting with some particular value, then for the infinite product 1.9.1.2.1 to converge, it is necessary and sufficient for $\sum_{k=1}^{\infty} a_k$ to converge.

1.9.1.4

The infinite product $\prod_{k=1}^{\infty} (1 + a_k)$ is said to **converge absolutely** if the infinite product $\prod_{k=1}^{\infty} (1 + |a_k|)$ converges.

1.9.1.5

Absolute convergence of an infinite product implies its convergence.

1.9.1.6

The infinite product $\prod_{k=1}^{\infty} (1 + a_k)$ converges absolutely if, and only if, the series $\sum_{k=1}^{\infty} a_k$ converges absolutely.

1.9.1.7

The infinite product $\prod_{k=1}^{\infty} |a_k| < \infty$ if, and only if, $\sum_{k=1}^{\infty} \ln|a_k| < \infty$.

1.9.2 Examples of Infinite Products

$$1. \quad \prod_{k=1}^{\infty} \left(1 + \frac{(-1)^{k+1}}{2k-1} \right) = \sqrt{2}$$

$$2. \quad \prod_{k=2}^{\infty} \left(1 - \frac{1}{k^2} \right) = \frac{1}{2}$$

$$3. \quad \prod_{k=1}^{\infty} \left(1 - \frac{1}{(2k+1)^2} \right) = \frac{\pi}{4}$$

$$4. \quad \prod_{k=2}^{\infty} \left(1 - \frac{2}{k(k+1)} \right) = \frac{1}{3}$$

$$5. \quad \prod_{k=2}^{\infty} \left(1 - \frac{1}{k^3+1} \right) = \frac{2}{3}$$

$$6. \quad \prod_{k=2}^{\infty} \left(1 + \frac{1}{2^k-2} \right) = 2$$

$$7. \quad \prod_{k=2}^{\infty} \left(1 + \frac{1}{k^2-1} \right) = 2$$

$$8. \quad \prod_{k=1}^{\infty} \left(1 - \frac{1}{4k^2} \right) = \frac{2}{\pi}$$

9. $\prod_{k=1}^{\infty} \left(1 - \frac{1}{9k^2}\right) = \frac{3^{3/2}}{2\pi}$
10. $\prod_{k=1}^{\infty} \left(1 - \frac{1}{16k^2}\right) = \frac{2^{3/2}}{\pi}$
11. $\prod_{k=1}^{\infty} \left(1 - \frac{1}{36k^2}\right) = \frac{3}{\pi}$
12. $\prod_{k=0}^{\infty} \left(1 + \left(\frac{1}{2}\right)^{2^k}\right) = 2$
13. $\frac{2}{1} \cdot \left(\frac{4}{3}\right)^{1/2} \left(\frac{6 \cdot 8}{5 \cdot 7}\right)^{1/4} \left(\frac{10 \cdot 12 \cdot 14 \cdot 16}{9 \cdot 11 \cdot 13 \cdot 15}\right)^{1/8} \cdots = e$
14. $\sqrt{\frac{1}{2}} \cdot \sqrt{\frac{1}{2} + \frac{1}{2}\sqrt{\frac{1}{2}}} \cdot \sqrt{\frac{1}{2} + \frac{1}{2}\sqrt{\frac{1}{2} + \frac{1}{2}\sqrt{\frac{1}{2}}}} \cdots = \frac{2}{\pi}$ (Vieta's formula)
15. $\prod_{k=1}^{\infty} \left(\frac{2k}{2k-1}\right) \left(\frac{2k}{2k+1}\right) = \frac{2}{1} \cdot \frac{2}{3} \cdot \frac{4}{3} \cdot \frac{4}{5} \cdot \frac{6}{5} \cdot \frac{6}{7} \cdots = \frac{\pi}{2}$ (Wallis's formula)
16. $\prod_{k=1}^{\infty} \left(1 - \frac{x^2}{k^2\pi^2}\right) = \frac{\sin x}{x}$
17. $\prod_{k=0}^{\infty} \left(1 - \frac{4x^2}{(2k+1)^2\pi^2}\right) = \cos x$
18. $\prod_{k=1}^{\infty} \left(1 + \frac{x^2}{k^2\pi^2}\right) = \frac{\sinh x}{x}$
19. $\prod_{k=0}^{\infty} \left(1 + \frac{4x^2}{(2k+1)^2\pi^2}\right) = \cosh x$

1.10 FUNCTIONAL SERIES

1.10.1 Uniform Convergence

1.10.1.1

Let $\{f_k(x)\}, k = 1, 2, \dots$, be an infinite sequence of functions. Then a series of the form

$$1. \sum_{k=1}^{\infty} f_k(x),$$

is called a **functional series**. The set of values of the independent variable x for which the series converges is called the **region of convergence** of the series.

1.10.1.2

Let D be a region in which the functional series 1.10.1.1.1 converges for each value of x . Then the series is said to **converge uniformly** in D if, for every $\varepsilon > 0$, there exists a number $N(\varepsilon)$ such that, for $n > N$, it follows that

$$1. \quad \left| \sum_{k=n+1}^{\infty} f_k(x) \right| < \varepsilon,$$

for all x in D .

The **Cauchy criterion** for the uniform convergence of series 1.10.1.1.1 requires that

$$2. \quad |f_m(x) + f_{m+1}(x) + \cdots + f_n(x)| < \varepsilon,$$

for every $\varepsilon > 0$, all x in D and all $n > m > N$.

1.10.1.3

Let $\{f_k(x)\}, k = 1, 2, \dots$, be an infinite sequence of functions, and let $\{M_k\}, k = 1, 2, \dots$, be a sequence of positive numbers such that $\sum_{k=1}^{\infty} M_k$ is convergent. Then, if

$$1. \quad |f_k(x)| \leq M_k,$$

for all x in a region D and all $k = 1, 2, \dots$, the functional series in 1.10.1.1.1 converges uniformly for all x in D . **(Weierstrass's M test)**

1.10.1.4

Let the series 1.10.1.1.1 converge for all x in some region D , in which it defines a function

$$1. \quad f(x) = \sum_{k=1}^{\infty} f_k(x).$$

Then the series is said to **converge uniformly** to $f(x)$ in D if, for every $\varepsilon > 0$, there exists a number $N(\varepsilon)$ such that, for $n > N$, it follows that

$$2. \quad \left| f(x) - \sum_{k=0}^n f_k(x) \right| < \varepsilon$$

for all x in D .

1.10.1.5

Let the infinite sequence of functions $\{f_k(x)\}, k = 1, 2, \dots$, be continuous for all x in some region D . Then if the functional series $\sum_{k=1}^{\infty} f_k(x)$ is uniformly convergent to the function $f(x)$ for all x in D , the function $f(x)$ is continuous in D .

1.10.1.6

Suppose the series 1.10.1.1.1 converges uniformly in a region D , and that for each x in D the sequence of functions $\{g_k(x)\}, k = 1, 2, \dots$ is monotonic and uniformly bounded, so that for some number $L > 0$

- $|g_k(x)| \leq L$

for each $k = 1, 2, \dots$, and all x in D . Then the series

- $$\sum_{k=1}^{\infty} f_k(x) g_k(x)$$

converges uniformly in D .

(Abel's theorem)

1.10.1.7

Suppose the partial sums $S_n(x) = \sum_{k=1}^n f_k(x)$ of 1.10.1.1.1 are uniformly bounded, so that

- $$\left| \sum_{k=1}^n f_k(x) \right| < L$$

for some L , all $n = 1, 2, \dots$, and all x in the region of convergence D . Then, if $\{g_k(x)\}, k = 1, 2, \dots$, is a monotonic decreasing sequence of functions that approaches zero uniformly for all x in D , the series

- $$\sum_{k=1}^{\infty} f_k(x) g_k(x)$$

converges uniformly in D .

(Dirichlet's theorem)

1.10.1.8

If each function in the infinite sequence of functions $\{f_k(x)\}, k = 1, 2, \dots$, is integrable on the interval $[a, b]$, and if the series 1.10.1.1.1 converges uniformly on this interval, the series may be **integrated term by term (termwise)**, so that

- $$\int_a^b \left[\sum_{k=1}^{\infty} f_k(x) \right] dx = \sum_{k=1}^{\infty} \int_a^b f_k(x) dx \quad [a \leq x \leq b].$$

1.10.1.9

Let each function in the infinite sequence of functions $\{f_k(x)\}, k = 1, 2, \dots$, have a continuous derivative $f'_k(x)$ on the interval $[a, b]$. Then if series 1.10.1.1.1 converges on this interval, and if the series $\sum_{k=1}^{\infty} f'_k(x)$ converges uniformly on the same interval, the series 1.10.1.1.1 may be **differentiated term by term (termwise)**, so that

$$\frac{d}{dx} \left[\sum_{k=1}^{\infty} f_k(x) \right] dx = \sum_{k=1}^{\infty} f'_k(x).$$

1.11 POWER SERIES

1.11.1 Definition

1.11.1.1

A functional series of the form

$$1. \quad \sum_{k=0}^{\infty} a_k (x - x_0)^k = a_0 + a_1 (x - x_0) + a_2 (x - x_0)^2 + \dots$$

is called a **power series** in x expanded about the point x_0 with **coefficients** a_k . The following is true of any power series: If it is not everywhere convergent, the region of convergence (in the complex plane) is a circle of radius R with its center at the point x_0 ; at every interior point of this circle the power series 1.11.1.1 converges absolutely, and outside this circle it diverges. The circle is called the **circle of convergence** and its radius R is called the **radius of convergence**. A series that converges at all points of the complex plane is said to have an infinite radius of convergence ($R = +\infty$).

1.11.1.2

The radius of convergence R of the power series in 1.11.1.1 may be determined by

$$1. \quad R = \lim_{k \rightarrow \infty} \left| \frac{a_k}{a_{k+1}} \right|,$$

when the limit exists; by

$$2. \quad R = \frac{1}{\lim_{k \rightarrow \infty} |a_k|^{1/k}},$$

when the limit exists; or by the **Cauchy–Hadamard formula**

$$3. \quad R = \frac{1}{\limsup |a_k|^{1/k}},$$

which is always defined (though the result is difficult to apply).

The **circle of convergence** of the power series in 1.11.1.1 is $|x - x_0| = R$, so the series is absolutely convergent in the open disk

$$|x - x_0| < R$$

and divergent outside it where x and x_0 are points in the complex plane.

1.11.1.3

The power series 1.11.1.1 may be integrated and differentiated term by term inside its circle of convergence; thus

1. $\int_{x_0}^x \left[\sum_{k=0}^{\infty} a_k (x - x_0)^k \right] dx = \sum_{k=0}^{\infty} \frac{a_k}{k+1} (x - x_0)^{k+1},$
2. $\frac{d}{dx} \left[\sum_{k=0}^{\infty} a_k (x - x_0)^k \right] = \sum_{k=1}^{\infty} k a_k (x - x_0)^{k-1}.$

The radii of convergence of the series 1.11.1.3.1 and 1.11.1.3.2 just given are both the same as that of the original series 1.11.1.1.1.

Operations on power series.

1.11.1.4

Let $\sum_{k=0}^{\infty} a_k (x - x_0)^k$ and $\sum_{k=0}^{\infty} b_k (x - x_0)^k$ be two power series expanded about x_0 . Then the quotient of these series

$$1. \quad \frac{\sum_{k=0}^{\infty} b_k (x - x_0)^k}{\sum_{k=0}^{\infty} a_k (x - x_0)^k} = \frac{1}{a_0} \sum_{k=0}^{\infty} c_k (x - x_0)^k,$$

where the c_k follow from the equations

$$2. \quad \begin{aligned} b_0 &= c_0 \\ a_0 b_1 &= a_0 c_1 + a_1 c_0 \\ a_0 b_2 &= a_0 c_2 + a_1 c_1 + a_2 c_0 \\ a_0 b_3 &= a_0 c_3 + a_1 c_2 + a_2 c_1 + a_3 c_0 \\ &\vdots \end{aligned}$$

$$a_0 c_n + \sum_{k=1}^n a_k c_{n-k} - a_0 b_n = 0$$

or from

$$3. \quad c_n = \frac{(-1)^n}{a_0^n} \begin{vmatrix} a_1 b_0 - a_0 b_1 & a_0 & 0 & \cdots & 0 \\ a_2 b_0 - a_0 b_2 & a_1 & a_0 & \cdots & 0 \\ a_3 b_0 - a_0 b_3 & a_2 & a_1 & \cdots & 0 \\ \vdots & \vdots & \vdots & \vdots & \vdots \\ a_{n-1} b_0 - a_0 b_{n-1} & a_{n-2} & a_{n-3} & \cdots & a_0 \\ a_n b_0 - a_0 b_n & a_{n-1} & a_{n-2} & \cdots & a_1 \end{vmatrix}, \quad c_0 = b_0/a_0.$$

For example, if $a_k = 1/k!$, $b_k = 2^k/k!$, $x_0 = 0$, it follows that $\sum_{k=0}^{\infty} a_k (x - x_0)^k = e^x$ and $\sum_{k=0}^{\infty} b_k (x - x_0)^k = e^{2x}$, so in this case

$$\sum_{k=0}^{\infty} b_k (x - x_0)^k \bigg/ \sum_{k=0}^{\infty} a_k (x - x_0)^k = e^{2x}/e^x = e^x.$$

This is confirmed by the above method, because from 1.11.1.4.2, $c_0 = 1, c_1 = 1, c_2 = \frac{1}{2}, c_3 = \frac{1}{6}, \dots$, so, as expected,

$$\left(\sum_{k=0}^{\infty} x^k/k! \right) / \left[\sum_{k=0}^{\infty} (2x)^k/k! \right] = 1 + x + \frac{x^2}{2} + \frac{x^3}{6} + \dots = 1 + x + \frac{x^2}{2!} + \frac{x^3}{3!} + \dots = e^x.$$

1.11.1.5

Let $\sum_{k=0}^{\infty} a_k (x - x_0)^k$ be a power series expanded about x_0 , and let n be a natural number. Then, when this power series is **raised to the power n** , we have

$$1. \quad \left[\sum_{k=0}^{\infty} a_k (x - x_0)^k \right]^n = \sum_{k=0}^{\infty} c_k (x - x_0)^k,$$

where

$$c_0 = a_0^n, \quad c_m = \frac{1}{m a_0} \sum_{k=1}^m (kn - m + k) a_k c_{m-k} \quad [m \geq 1].$$

For example, if $a_k = 1/k!, x_0 = 0, n = 3$, it follows that

$$\sum_{k=0}^{\infty} a_k (x - x_0)^k = e^x, \quad \text{so} \quad \left[\sum_{k=0}^{\infty} a_k (x - x_0)^k \right]^n = e^{3x}.$$

This is confirmed by the above method, because from 1.11.1.5.2, $c_0 = 1, c_1 = 3, c_2 = 9/2, c_3 = 9/2, \dots$, so, as expected,

$$\begin{aligned} \left(\sum_{k=0}^{\infty} x^k/k! \right)^3 &= 1 + 3x + \frac{9}{2}x^2 + \frac{9}{2}x^3 + \dots \\ &= 1 + 3x + \frac{(3x)^2}{2!} + \frac{(3x)^3}{3!} + \dots = e^{3x}. \end{aligned}$$

1.11.1.6

Let $y = \sum_{k=1}^{\infty} a_k (x - x_0)^k$ and $\sum_{k=1}^{\infty} b_k y^k$ be two power series. Then substituting for y in the second power series gives

$$1. \quad \sum_{k=1}^{\infty} b_k y^k = \sum_{k=1}^{\infty} c_k (x - x_0)^k, \quad \text{where}$$

$$2. \quad c_1 = a_1 b_1, \quad c_2 = a_2 b_1 + a_1^2 b_2, \quad c_3 = a_3 b_1 + 2a_1 a_2 b_2 + a_1^3 b_3, \\ c_4 = a_4 b_1 + a_2^2 b_2 + 2a_1 a_3 b_2 + 3a_1^2 a_2 b_3 + a_1^4 b_4, \dots$$

For example, if $a_k = (-1)^k / (k+1)$, $b_k = 1/k!$, $x_0 = 0$, it follows that $y = \sum_{k=1}^{\infty} a_k (x-x_0)^k = \ln(1+x)$, and $\sum_{k=1}^{\infty} b_k y^k = e^y - 1$, so the result of substituting for y is to give $\sum_{k=1}^{\infty} b_k y^k = \exp\{\ln(1+x)\} - 1 = x$. This is confirmed by the above method, because from 1.11.1.6.2, $c_1 = 1$, $c_2 = c_3 = c_4 = \dots = 0$ so, as expected.

$$\sum_{k=1}^{\infty} b_k y^k = \sum_{k=1}^{\infty} c_k (x-x_0)^k = x.$$

1.11.1.7

Let $\sum_{k=0}^{\infty} a_k (x-x_0)^k$ and $\sum_{k=0}^{\infty} b_k (x-x_0)^k$ be two power series expanded about x_0 . Then the **product** of these series is given by

$$1. \quad \left[\sum_{k=0}^{\infty} a_k (x-x_0)^k \right] \left[\sum_{k=0}^{\infty} b_k (x-x_0)^k \right] = \sum_{k=0}^{\infty} c_k (x-x_0)^k,$$

where

$$2. \quad c_n = \sum_{k=0}^n a_k b_{n-k}, \quad c_0 = a_0 b_0.$$

For example, if $a_k = 1/k!$, $b_k = 1/k!$, $x_0 = 0$, it follows that

$$\sum_{k=0}^{\infty} a_k (x-x_0)^k = \sum_{k=0}^{\infty} b_k (x-x_0)^k = e^x,$$

so in this case

$$\left[\sum_{k=0}^{\infty} a_k (x-x_0)^k \right] \left[\sum_{k=0}^{\infty} b_k (x-x_0)^k \right] = e^x \cdot e^x = e^{2x}.$$

This is confirmed by the above method, because from 1.11.1.7.2 $c_0 = 1$, $c_1 = 2$, $c_2 = 2$, $c_3 = 4/3, \dots$, so, as expected,

$$\left(\sum_{k=0}^{\infty} x^k / k! \right) \left(\sum_{k=0}^{\infty} x^k / k! \right) = 1 + 2x + 2x^2 + \frac{4}{3}x^3 + \dots \\ = 1 + 2x + \frac{(2x)^2}{2!} + \frac{(2x)^3}{3!} + \dots = e^{2x}.$$

1.11.1.8

Let

$$1. \quad y - y_0 = \sum_{k=1}^{\infty} a_k (x - x_0)^k$$

be a power series expanded about x_0 . Then the **reversion** of this power series corresponds to finding a power series in $y - y_0$, expanded about y_0 , that represents the function inverse to the one defined by the power series in 1.11.1.8.1. Thus, if the original series is written concisely as $y = f(x)$, reversion of the series corresponds to finding the power series for the inverse function $x = f^{-1}(y)$. The reversion of the series in 1.11.1.8.1 is given by

$$2. \quad x - x_0 = \sum_{k=1}^{\infty} A_k (y - y_0)^k,$$

where

$$3. \quad A_1 = \frac{1}{a_1}, \quad A_2 = \frac{-a_2}{a_1^3}, \quad A_3 = \frac{2a_2^2 - a_1 a_3}{a_1^3}$$

$$A_4 = \frac{5a_1 a_2 a_3 - a_1^2 a_4 - 5a_2^3}{a_1^7},$$

$$A_5 = \frac{6a_1^2 a_2 a_4 + 3a_1^2 a_3^2 + 14a_2^4 - a_1^3 a_5 - 21a_1 a_2^2 a_3}{a_1^9}$$

$$A_6 = \frac{7a_1^3 a_2 a_5 + 7a_1^3 a_3 a_4 + 84a_1 a_2^3 a_3 - a_1^4 a_6 - 28a_1^2 a_2 a_3^2 - 42a_2^5 - 28a_1^2 a_2^2 a_4}{a_1^{11}}.$$

$$\vdots$$

For example, give the power series

$$y = \operatorname{arc} \sinh x = x - \frac{1}{6}x^3 + \frac{3}{40}x^5 - \frac{15}{336}x^7 + \cdots,$$

setting $x_0 = 0$, $y_0 = 0$, $a_1 = 1$, $a_2 = 0$, $a_3 = -1/6$, $a_4 = 0$, $a_5 = 3/40, \dots$, it follows from 1.11.1.8.3 that $A_1 = 1$, $A_2 = 0$, $A_3 = 1/6$, $A_4 = 0$, $A_5 = 1/120, \dots$, so, as would be expected,

$$x = \sinh y = y + \frac{y^3}{6} + \frac{y^5}{120} + \cdots = y + \frac{y^3}{3!} + \frac{y^5}{5!} + \cdots.$$

1.12 TAYLOR SERIES**1.12.1 Definition and Forms of Remainder Term**

If a function $f(x)$ has derivatives of all orders in some interval containing the point x_0 , the power series in $x - x_0$ of the form

$$1. \quad f(x_0) + (x - x_0) f^{(1)}(x_0) + \frac{(x - x_0)^2}{2!} f^{(2)}(x_0) + \frac{(x - x_0)^3}{3!} f^{(3)}(x_0) + \cdots,$$

where $f^{(n)}(x_0) = (d^n f/dx^n)_{x=x_0}$, is called the **Taylor series** expansion of $f(x)$ about x_0 .

The Taylor series expansion converges to the function $f(x)$ if the **remainder**

$$2. \quad R_n(x) = f(x) - f(x_0) - \sum_{k=1}^n \frac{(x-x_0)^k}{k!} f^{(k)}(x_0)$$

approaches zero as $n \rightarrow \infty$.

The remainder term $R_n(x)$ can be expressed in a number of different forms, including the following:

$$3. \quad R_n(x) = \frac{(x-x_0)^{n+1}}{(n+1)!} f^{(n+1)}[x_0 + \theta(x-x_0)] \quad [0 < \theta < 1]. \quad \text{(Lagrange form)}$$

$$4. \quad R_n(x) = \frac{(x-x_0)^{n+1}}{n!} (1-\theta)^n f^{(n+1)}[x_0 + \theta(x-x_0)] \quad [0 < \theta < 1]. \quad \text{(Cauchy form)}$$

$$5. \quad R_n(x) = \frac{\psi(x-x_0) - \psi(0)}{\psi'[(x-x_0)(1-\theta)]} \frac{(x-x_0)^n (1-\theta)^n}{n!} f^{(n+1)}[\xi + \theta(x-x_0)] \quad [0 < \theta < 1],$$

(Schlömlich form)

where $\psi(x)$ is an arbitrary function with the properties that (i) it and its derivative $\psi'(x)$ are continuous in the interval $(0, x-x_0)$ and (ii) the derivative $\psi'(x)$ does not change sign in that interval.

$$6. \quad R_n(x) = \frac{(x-x_0)^{n-1} (1-\theta)^{n-p-1}}{(p+1)n!} f^{(n+1)}[x_0 + \theta(x-x_0)] \quad [0 < p \leq n; 0 < \theta < 1].$$

[Rouché form obtained from 1.12.1.5 with $\psi(x) = x^{p+1}$].

$$7. \quad R_n(x) = \frac{1}{n!} \int_{x_0}^x f^{(n+1)}(t) (x-t)^n dt. \quad \text{(integral form)}$$

1.12.2

The Taylor series expansion of $f(x)$ is also written as:

$$1. \quad f(a+x) = \sum_{k=0}^{\infty} \frac{x^k}{k!} f^{(k)}(a) = f(a) + \frac{x}{1!} f^{(1)}(a) + \frac{x^2}{2!} f^{(2)}(a) + \dots$$

$$2. \quad f(x) = \sum_{k=0}^{\infty} \frac{x^k}{k!} f^{(k)}(0) = f(0) + \frac{x}{1!} f^{(1)}(0) + \frac{x^2}{2!} f^{(2)}(0) + \dots$$

(Maclaurin series: a Taylor series expansion about the origin).

1.12.3

The Taylor series expansion of a function $f(x, y)$ of the two variables that possesses partial derivatives of all orders in some region D containing the point (x_0, y_0) is:

$$1. \quad f(x, y) = f(x_0, y_0) + (x-x_0) \left(\frac{\partial f}{\partial x} \right)_{(x_0, y_0)} + (y-y_0) \left(\frac{\partial f}{\partial y} \right)_{(x_0, y_0)}$$

$$\begin{aligned}
& + \frac{1}{2!} \left[(x - x_0)^2 \left(\frac{\partial^2 f}{\partial x^2} \right)_{(x_0, y_0)} + 2(x - x_0)(y - y_0) \left(\frac{\partial^2 f}{\partial x \partial y} \right)_{(x_0, y_0)} \right. \\
& \left. + (y - y_0)^2 \left(\frac{\partial^2 f}{\partial y^2} \right)_{(x_0, y_0)} \right] + \cdots .
\end{aligned}$$

In its simplest form the remainder term $R_n(x, y)$ satisfies a condition analogous to 1.12.1.3, so that

$$2. \quad R_n(x, y) = \frac{1}{(n+1)!} (D_{n+1}f)_{(x_0+\theta_1(x-x_0), y_0+\theta_2(y-y_0))} \quad [0 < \theta_1 < 1, 0 < \theta_2 < 1]$$

where

$$3. \quad D_n \equiv \left((x - x_0) \frac{\partial}{\partial x} + (y - y_0) \frac{\partial}{\partial y} \right)^n .$$

1.12.4 Order Notation (Big O and Little o)

When working with a function $f(x)$ it is useful to have a simple notation that indicates its order of magnitude, either for all x , or in a neighborhood of a point x_0 .

This is provided by the so-called ‘big oh’ and ‘little oh’ notation.

1. We write

$$f(x) = O[\varphi(x)],$$

and say $f(x)$ is of order $\varphi(x)$, or is ‘big oh’ $\varphi(x)$, if there exists a real constant K such that

$$|f(x)| \leq K |\varphi(x)| \quad \text{for all } x.$$

The function $f(x)$ is said to be of the order of $\varphi(x)$, or to be ‘big oh’ $\varphi(x)$ in a neighborhood of x_0 , written $f(x) = O(\varphi(x))$ as $x \rightarrow x_0$ if

$$|f(x)| \leq K |\varphi(x)| \quad \text{as } x \rightarrow x_0.$$

2. If in a neighborhood of a point x_0 two functions $f(x)$ and $g(x)$ are such that

$$\lim_{x \rightarrow x_0} \left[\frac{f(x)}{g(x)} \right] = 0$$

the function $f(x)$ is said to be of smaller order than $g(x)$, or to be ‘little oh’ $g(x)$, written

$$f(x) = o(g(x)) \quad \text{as } x \rightarrow x_0.$$

In particular, these notations are useful when representing the error term in Taylor series expansions and when working with asymptotic expansions.

Examples

1. $f(x) = O(1)$ means $f(x)$ is bounded for all x .
2. $f(x) = o(1)$ as $x \rightarrow x_0$ means $f(x) \rightarrow 0$ as $x \rightarrow x_0$.
3. $\sinh x - \left(x + \frac{1}{3!}x^3\right) = O(x^5)$ as $x \rightarrow 0$.
4. $x^2/(1+x^3) = o(1+x^3)$ as $x \rightarrow \infty$.

1.13 FOURIER SERIES**1.13.1 Definitions****1.13.1.1**

Let $f(x)$ be a function that is defined over the interval $[-l, l]$, and by periodic extension outside it; that is,

1. $f(x - 2l) = f(x)$, for all x .

Suppose also that $f(x)$ is absolutely integrable (possibly improperly) over the interval $(l, -l)$; that is $\int_{-l}^l |f(x)|dx$ is finite. Then the **Fourier series** of $f(x)$ is the trigonometric series

$$2. \quad \frac{1}{2}a_0 + \sum_{k=1}^{\infty} \left(a_k \cos \frac{k\pi x}{l} + b_k \sin \frac{k\pi x}{l} \right),$$

where the **Fourier coefficients** a_k, b_k are given by the formulas:

$$3. \quad a_k = \frac{1}{l} \int_{-l}^l f(t) \cos \frac{k\pi t}{l} dt = \frac{1}{l} \int_{\alpha}^{\alpha+2l} f(t) \cos \frac{k\pi t}{l} dt \quad [\text{any real } \alpha, k = 0, 1, 2, \dots],$$

$$4. \quad b_k = \frac{1}{l} \int_{-l}^l f(t) \sin \frac{k\pi t}{l} dt = \frac{1}{l} \int_{\alpha}^{\alpha+2l} f(t) \sin \frac{k\pi t}{l} dt \quad [\text{any real } \alpha, k = 1, 2, 3, \dots].$$

*Convergence of Fourier series.***1.13.1.2**

It is important to know in what sense the Fourier series of $f(x)$ represents the function $f(x)$ itself. This is the question of the **convergence** of Fourier series, which is discussed next. The Fourier series of a function $f(x)$ at a point x_0 converges to the number

$$1. \quad \frac{f(x_0 + 0) + f(x_0 - 0)}{2},$$

if, for some $h > 0$, the integral

$$2. \int_0^h \frac{|f(x_0 + t) + f(x_0 - t) - f(x_0 + 0) - f(x_0 - 0)|}{t} dt$$

exists, where it is assumed that $f(x)$ is either continuous at x_0 or it has a finite jump discontinuity at x_0 (a **saltus**) at which both the one-sided limits $f(x_0 - 0)$ and $f(x_0 + 0)$ exist. Thus, if $f(x)$ is continuous at x_0 , the Fourier series of $f(x)$ converges to the value $f(x_0)$ at the point x_0 , while if a finite jump discontinuity occurs at x_0 the Fourier series converges to the average of the values $f(x_0 + 0)$ and $f(x_0 - 0)$ of $f(x)$ to the immediate left and right of x_0 . (**Dini's condition**)

1.13.1.3

A function $f(x)$ is said to satisfy **Dirichlet conditions** on the interval $[a, b]$ if it is bounded on the interval, and the interval $[a, b]$ can be partitioned into a finite number of subintervals inside each of which the function $f(x)$ is continuous and monotonic (either increasing or decreasing).

The Fourier series of a periodic function $f(x)$ that satisfies Dirichlet conditions on the interval $[a, b]$ converges at every point x_0 of $[a, b]$ to the value $\frac{1}{2} \{f(x_0 + 0) + f(x_0 - 0)\}$. (**Dirichlet's result**)

1.13.1.4

Let the function $f(x)$ be defined on the interval $[a, b]$, where $a < b$, and let the interval be partitioned into subintervals in an arbitrary manner with the ends of the intervals at

$$1. \quad a = x_0 < x_1 < x_2 < \cdots < x_{n-1} < x_n = b.$$

Form the sum

$$2. \quad \sum_{k=1}^n |f(x_k) - f(x_{k-1})|.$$

Then different partitions of the interval $[a, b]$ that is, different choices of the points x_k , will give rise to different sums of the form in 1.13.1.4.2. If the set of these sums is bounded above, the function $f(x)$ is said to be of **bounded variation** on the interval $[a, b]$. The least upper bound of these sums is called the **total variation** of the function $f(x)$ on the interval $[a, b]$.

1.13.1.5

Let the function $f(x)$ be piecewise-continuous on the interval $[a, b]$, and let it have a piecewise-continuous derivative within each such interval in which it is continuous. Then, at every point x_0 of the interval $[a, b]$, the Fourier series of the function $f(x)$ converges to the value $\frac{1}{2} \{f(x_0 + 0) + f(x_0 - 0)\}$.

1.13.1.6

A function $f(x)$ defined in the interval $[0, l]$, can be expanded in a cosine series (**half-range Fourier cosine series**) of the form

$$1. \quad \frac{1}{2}a_0 + \sum_{k=1}^{\infty} a_k \cos \frac{k\pi x}{l},$$

where

$$2. \quad a_k = \frac{2}{l} \int_0^l f(t) \cos \frac{k\pi t}{l} dt \quad [k = 0, 1, 2, \dots].$$

1.13.1.7

A function $f(x)$ defined in the interval $[0, l]$ can be expanded in a sine series (**half-range Fourier sine series**):

$$1. \quad \sum_{k=1}^{\infty} b_k \sin \frac{k\pi x}{l},$$

where

$$2. \quad b_k = \frac{2}{l} \int_0^l f(t) \sin \frac{k\pi t}{l} dt \quad [k = 1, 2, \dots].$$

The convergence tests for these half-range Fourier series are analogous to those given in 1.13.1.2 to 1.13.1.5.

1.13.1.8

The Fourier coefficients a_k, b_k defined in 1.13.1.1 for a function $f(x)$ that is absolutely integrable over $[-l, l]$ are such that

$$\lim_{k \rightarrow \infty} a_k = 0 \quad \text{and} \quad \lim_{k \rightarrow \infty} b_k = 0. \quad (\text{Riemann–Lebesgue lemma})$$

1.13.1.9

Let $f(x)$ be a piecewise-smooth or piecewise-continuous function defined on the interval $[-l, l]$, and by periodic extension outside it. Then for all real x the **complex Fourier series** for $f(x)$ is

$$1. \quad \lim_{m \rightarrow \infty} \sum_{k=-m}^m c_k \exp[ik\pi x/l],$$

where

$$2. \quad c_k = \frac{1}{2l} \int_{-l}^l f(x) e^{-ik\pi x/l} dx \quad [k = 0, \pm 1, \pm 2, \dots].$$

The convergence properties and conditions for convergence of complex Fourier series are analogous to those already given for Fourier series.

1.13.1.10

The n 'th partial sum $s_n(x)$ of a Fourier series for $f(x)$ on the interval $(-\pi, \pi)$, defined by

1. $s_n(x) = \frac{1}{2}a_0 + \sum_{k=1}^n (a_k \cos kx + b_k \sin kx)$ is given by the **Dirichlet integral representation**:

$$2. \quad s_n(x) = \frac{1}{\pi} \int_{-\pi}^{\pi} f(\tau) \frac{\sin \left[\left(n + \frac{1}{2} \right) (x - \tau) \right]}{2 \sin \frac{1}{2} (x - \tau)} d\tau,$$

where

$$3. \quad D_n(x) = \frac{1}{2\pi} \frac{\sin \left[\left(n + \frac{1}{2} \right) (x - \tau) \right]}{\sin \frac{1}{2} (x - \tau)}$$

is called the **Dirichlet kernel**.

$$4. \quad \frac{1}{\pi} \int_{-\pi}^{\pi} D_n(x) dx = 1.$$

1.13.1.11

Let $f(x)$ be continuous and piecewise-smooth on the interval $(-l, l)$, with $f(-l) = f(l)$. Then the Fourier series of $f(x)$ converges uniformly to $f(x)$ for x in the interval $(-l, l)$.

1.13.1.12

Let $f(x)$ be piecewise-continuous on $[-l, l]$ with the Fourier series given in 1.13.1.1.2. Then term-by-term integration of the Fourier series for $f(x)$ yields a series representation of the function

$$F(x) = \int_{\alpha}^x f(t) dt, \quad [-l \leq \alpha < x < l].$$

When expressed differently, this result is equivalent to

$$\int_{-l}^x f(t) dt = \int_{-l}^x \frac{a_0}{2} dt + \sum_{k=1}^{\infty} \int_{-l}^x \left(a_k \cos \frac{k\pi t}{l} + b_k \sin \frac{k\pi t}{l} \right) dt$$

(integration of Fourier series)

1.13.1.13

Let $f(x)$ be a continuous function over the interval $[-l, l]$ and such that $f(-l) = f(l)$. Suppose also that the derivative $f'(x)$ is piecewise-continuous over this interval. Then at every point at

which $f''(x)$ exists, the Fourier series for $f(x)$ may be differentiated term by term to yield a Fourier series that converges to $f'(x)$. Thus, if $f(x)$ has the Fourier series given in 1.13.1.1.2,

$$f'(x) = \sum_{k=1}^{\infty} \frac{d}{dx} \left(a_k \cos \frac{k\pi x}{l} + b_k \sin \frac{k\pi x}{l} \right) \quad [-l \leq x \leq l].$$

(differentiation of Fourier series)

1.13.1.14

Let $f(x)$ be a piecewise-continuous over $[-l, l]$ with the Fourier series given in 1.13.1.1.2. Then

$$\frac{1}{2}a_0^2 + \sum_{k=1}^{\infty} (a_k^2 + b_k^2) \leq \frac{1}{l} \int_{-l}^l [f(x)]^2 dx. \quad (\text{Bessel's inequality})$$

1.13.1.15

Let $f(x)$ be continuous over $[-l, l]$, and periodic with period $2l$, with the Fourier series given in 1.13.1.2. Then

$$\frac{1}{2}a_0^2 + \sum_{k=1}^{\infty} (a_k^2 + b_k^2) = \frac{1}{l} \int_{-l}^l [f(x)]^2 dx. \quad (\text{Parseval's identity})$$

1.13.1.16

Let $f(x)$ and $g(x)$ be two functions defined over the interval $[-l, l]$ with respective Fourier coefficients a_k, b_k and α_k, β_k , and such that the integrals $\int_{-l}^l [f(x)]^2 dx$ and $\int_{-l}^l [g(x)]^2 dx$ are both finite [$f(x)$ and $g(x)$ are **square integrable**]. Then the **Parseval identity** for the product function $f(x)g(x)$ becomes

$$\frac{a_0\alpha_0}{2} + \sum_{k=1}^{\infty} (a_k\alpha_k + b_k\beta_k) = \frac{1}{l} \int_{-l}^l f(x)g(x) dx.$$

(generalized Parseval identity)

1.14 ASYMPTOTIC EXPANSIONS

1.14.1 Introduction

1.14.1.1

Among the set of all divergent series is a special class known as the **asymptotic series**. These are series which, although divergent, have the property that the sum of a suitable number of terms provides a good approximation to the functions they represent. In the case of an alternating asymptotic series, the greatest accuracy is obtained by truncating the series at the term of smallest absolute value. When working with an alternating asymptotic series representing a function $f(x)$, the magnitude of the error involved when $f(x)$ is approximated by summing only the first n terms of the series does not exceed the magnitude of the $(n+1)$ 'th term (the first term to be discarded).

An example of this type is provided by the asymptotic series for the function

$$f(x) = \int_x^\infty \frac{e^{x-t}}{t} dt.$$

Integrating by parts n times gives

$$f(x) = \frac{1}{x} - \frac{1}{x^2} + \frac{2!}{x^3} - \cdots + (-1)^{n-1} \frac{(n-1)!}{x^n} + (-1)^n n! \int_x^\infty \frac{e^{x-t}}{t^{n+1}} dt.$$

It is easily established that the infinite series

$$\frac{1}{x} - \frac{1}{x^2} + \frac{2!}{x^3} - \cdots + (-1)^{n-1} \frac{(n-1)!}{x^n} + \cdots$$

is divergent for all x , so if $f(x)$ is expanded as an infinite series, the series diverges for all x .

The remainder after the n 'th term can be estimated by using the fact that

$$n! \int_x^\infty \frac{e^{x-t}}{t^{n+1}} dt < \frac{n!}{x^{n+1}} \int_x^\infty e^{x-t} dt = \frac{n!}{x^{n+1}},$$

from which it can be seen that when $f(x)$ is approximated by the first n terms of this divergent series, the magnitude of the error involved is less than the magnitude of the $(n+1)$ 'th term (see 1.8.2.7.2).

For any fixed value of x , the terms in the divergent series decrease in magnitude until the N 'th term, where N is the integral part of x , after which they increase again. Thus, for any fixed x , truncating the series after the N 'th term will yield the best approximation to $f(x)$ for that value of x .

In general, even when x is only moderately large, truncating the series after only a few terms will provide an excellent approximation to $f(x)$. In the above case, if $x = 30$ and the series is truncated after only two terms, the magnitude of the error involved when evaluating $f(30)$ is less than $2!/30^3 = 7.4 \times 10^{-5}$.

1.14.2 Definition and Properties of Asymptotic Series

1. Let $S_n(z)$ be the sum of the first $(n+1)$ terms of the series

$$S(z) = A_0 + \frac{A_1}{z} + \frac{A_2}{z^2} + \cdots + \frac{A_n}{z^n} + \cdots,$$

where, in general, z is a complex number. Let $R_n(z) = S(z) - S_n(z)$. Then the series $S(z)$ is said to be an **asymptotic expansion** of $f(z)$ if for $\arg z$ in some interval $\alpha \leq \arg z \leq \beta$, and for each fixed n ,

$$\lim_{|z| \rightarrow \infty} z^n R_n(z) = 0.$$

The relationship between $f(z)$ and its asymptotic expansion $S(z)$ is indicated by writing $f(z) \sim S(z)$.

2. The operations of addition, subtraction, multiplication, and raising to a power can be performed on asymptotic series just as on absolutely convergent series. The series obtained as a result of these operations will also be an asymptotic series.
3. Division of asymptotic series is permissible and yields another asymptotic series provided the first term A_0 of the divisor is not equal to zero.
4. Term-by-term integration of an asymptotic series is permissible and yields another asymptotic series.
5. Term-by-term differentiation of an asymptotic series is *not*, in general, permissible.
6. For $\arg z$ in some interval $\alpha \leq \arg z \leq \beta$, the asymptotic expansion of a function $f(x)$ is unique.
7. A series can be the asymptotic expansion of more than one function.

1.15 BASIC RESULTS FROM THE CALCULUS

1.15.1 Rules for Differentiation

1.15.1.1

Let u, v be differentiable functions of their arguments and let k be a constant.

$$1. \quad \frac{dk}{dx} = 0$$

$$2. \quad \frac{d(ku)}{dx} = k \frac{du}{dx}$$

$$3. \quad \frac{d(u+v)}{dx} = \frac{du}{dx} + \frac{dv}{dx} \quad \text{(differentiation of a sum)}$$

$$4. \quad \frac{d(uv)}{dx} = u \frac{dv}{dx} + v \frac{du}{dx} \quad \text{(differentiation of a product)}$$

$$5. \quad \frac{d}{dx} (u/v) = \frac{v \frac{du}{dx} - u \frac{dv}{dx}}{v^2} \quad [v \neq 0] \quad \text{(differentiation of a quotient)}$$

6. Let v be differentiable at some point x , and u be differentiable at the point $v(x)$; then the composite function $(u \circ v)(x)$ is differentiable at the point x . In particular, if $z = u(y)$ and $y = v(x)$, so that $z = u(v(x)) = (u \circ v)(x)$, then

$$\frac{dz}{dx} = \frac{dz}{dy} \cdot \frac{dy}{dx}$$

or, equivalently,

$$\frac{dz}{dx} = u'(y) v'(x) = u'(v(x)) v'(x). \quad \text{(chain rule)}$$

7. If the n 'th derivatives $u^{(n)}(x)$ and $v^{(n)}(x)$ exist, so also does $d^n(uv)/dx^n$ and

$$\frac{d^n(uv)}{dx^n} = \sum_{k=0}^n \binom{n}{k} u^{(n-k)}(x) v^{(k)}(x). \quad (\text{Leibnitz's formula})$$

In particular (for $n = 1$; see 1.15.1.1.3),

$$\frac{d^2(uv)}{dx^2} = \frac{d^2u}{dx^2}v + 2\frac{du}{dx}\frac{dv}{dx} + u\frac{d^2v}{dx^2} \quad [n = 2],$$

$$\frac{d^3(uv)}{dx^3} = \frac{d^3u}{dx^3}v + 3\frac{d^2u}{dx^2}\frac{dv}{dx} + 3\frac{du}{dx}\frac{d^2v}{dx^2} + u\frac{d^3v}{dx^3} \quad [n = 3].$$

8. Let the function $f(x)$ be continuous at each point of the closed interval $[a, b]$ and differentiable at each point of the open interval (a, b) . Then there exists a number ξ , with $a < \xi < b$, such that

$$f(b) - f(a) = (b - a) f'(\xi). \quad (\text{mean-value theorem for derivatives})$$

9. Let $f(x), g(x)$ be functions such that $f(x_0) = g(x_0) = 0$, but $f'(x_0)$ and $g'(x_0)$ are not both zero. Then

$$\lim_{x \rightarrow x_0} \frac{f(x)}{g(x)} = \frac{f'(x_0)}{g'(x_0)}. \quad (\text{L'Hôpital's rule})$$

Let $f(x), g(x)$ be functions such that $f(x_0) = g(x_0) = 0$, and let their first n derivatives all vanish at x_0 , so that $f^{(r)}(x_0) = g^{(r)}(x_0) = 0$, for $r = 1, 2, \dots, n$. Then, provided that not both of the $(n+1)$ 'th derivatives $f^{(n+1)}(x)$ and $g^{(n+1)}(x)$ vanish at x_0

$$\lim_{x \rightarrow x_0} \frac{f(x)}{g(x)} = \frac{f^{(n+1)}(x_0)}{g^{(n+1)}(x_0)}. \quad (\text{generalized L'Hôpital's rule})$$

1.15.2 Integration

1.15.2.1

A function $F(x)$ is called an **antiderivative** of a function $f(x)$ if

$$1. \quad \frac{d}{dx} [F(x)] = f(x).$$

The operation of determining an antiderivative is called **integration**. Functions of the form

$$2. \quad F(x) + C$$

are antiderivatives of $f(x)$ in 1.15.2.1.1 and this is indicated by writing

$$3. \int f(x) dx = F(x) + C,$$

where C is an arbitrary constant.

The expression on the right-hand side of 1.15.2.1.3 is called an **indefinite integral**. The term *indefinite* is used because of the arbitrariness introduced by the arbitrary additive **constant of integration** C .

$$4. \int u \left(\frac{dv}{dx} \right) dx = uv - \int v \left(\frac{du}{dx} \right) dx. \quad (\text{formula for integration by parts})$$

This is often abbreviated to

$$\int u dv = uv - \int v du.$$

5. A **definite integral** involves the integration of $f(x)$ from a **lower limit** $x = a$ to an upper limit $x = b$, and it is written

$$\int_a^b f(x) dx.$$

The **first fundamental theorem of calculus** asserts that if $f(x)$ is an antiderivative of $f(x)$, then

$$\int_a^b f(x) dx = F(b) - F(a).$$

Since the variable of integration in a definite integral does not enter into the final result it is called a **dummy variable**, and it may be replaced by any other symbol. Thus

$$\int_a^b f(x) dx = \int_a^b f(t) dt = \dots = \int_a^b f(s) ds = F(b) - F(a).$$

6. If

$$F(x) = \int_a^x f(t) dt,$$

then $dF/dx = f(x)$ or, equivalently,

$$\frac{d}{dx} \int_a^x f(t) dt = f(x). \quad (\text{second fundamental theorem of calculus})$$

$$7. \int_a^b f(x) dx = - \int_b^a f(x) dx. \quad (\text{reversal of limits changes the sign})$$

8. Let $f(x)$ and $g(x)$ be continuous in the interval $[a, b]$, and let $g'(x)$ exist and be continuous in this same interval. Then, with the substitution $u = g(x)$,

$$(i) \int f[g(x)]g'(x) dx = \int f(u) du,$$

(integration of indefinite integral by substitution)

$$(ii) \int_a^b f[g(x)]g'(x) dx = \int_{g(a)}^{g(b)} f(u) du.$$

(integration of a definite integral by substitution)

9. Let $f(x)$ be finite and integrable over the interval $[a, b]$ and let ξ be such that $a < \xi < b$, then

$$\int_{\xi-0}^{\xi+0} f(x) dx = 0. \quad \text{(integral over an interval of zero length)}$$

10. If ξ is a point in the closed interval $[a, b]$, then

$$\int_a^b f(x) dx = \int_a^{\xi} f(x) dx + \int_{\xi}^b f(x) dx.$$

(integration over contiguous intervals)

This result, in conjunction with 1.15.2.1.9, is necessary when integrating a piecewise-continuous function $f(x)$ over the interval $[a, b]$. Let

$$f(x) = \begin{cases} \varphi(x), & a \leq x \leq \xi \\ \psi(x), & \xi < x \leq b \end{cases}$$

with $\varphi(\xi - 0) \neq \psi(\xi + 0)$, so that $f(x)$ has a finite discontinuity (**saltus**) at $x = \xi$. Then

$$\int_a^b f(x) dx = \int_a^{\xi-0} f(x) dx + \int_{\xi+0}^b f(x) dx.$$

(integration of a discontinuous function)

$$11. \int_a^b u \left(\frac{dv}{dx} \right) dx = u(b)v(b) - u(a)v(a) - \int_a^b v \left(\frac{du}{dx} \right) dx.$$

(formula for integration by parts of a definite integral)

Using the notation $(uv)|_a^b = u(b)v(b) - u(a)v(a)$ this last result is often contracted to

$$\int_a^b u dv = (uv)|_a^b - \int_a^b v du.$$

$$12. \frac{d}{d\alpha} \int_{\psi(\alpha)}^{\varphi(\alpha)} f(x, \alpha) dx = f[\varphi(\alpha), \alpha] \frac{d\varphi(\alpha)}{d\alpha} - f[\psi(\alpha), \alpha] \frac{d\psi(\alpha)}{d\alpha}$$

$$+ \int_{\psi(\alpha)}^{\varphi(\alpha)} \frac{\partial}{\partial \alpha} [f(x, \alpha)] dx.$$

(differentiation of a definite integral with respect to a parameter)

13. If $f(x)$ is integrable over the interval $[a, b]$, then

$$\left| \int_a^b f(x) dx \right| \leq \int_a^b |f(x)| dx. \quad (\text{absolute value integral inequality})$$

14. If $f(x)$ and $g(x)$ are integrable over the interval $[a, b]$ and $f(x) \leq g(x)$, then

$$\int_a^b f(x) dx \leq \int_a^b g(x) dx. \quad (\text{comparison integral inequality})$$

15. The following are **mean-value theorems for integrals**.

(i) If $f(x)$ is continuous on the closed interval $[a, b]$, there is a number ξ , with $a < \xi < b$, such that

$$\int_a^b f(x) dx = (b - a) f(\xi).$$

(ii) If $f(x)$ and $g(x)$ are continuous on the closed interval $[a, b]$ and $g(x)$ is monotonic (either decreasing or increasing) on the open interval $[a, b]$, there is a number ξ , with $a < \xi < b$, such that

$$\int_a^b f(x) g(x) dx = g(a) \int_a^{\xi} f(x) dx + g(b) \int_{\xi}^b f(x) dx.$$

(iii) If in (ii), $g(x) > 0$ on the open interval $[a, b]$, there is a number ξ , with $a < \xi < b$, such that when $g(x)$ is monotonic decreasing

$$\int_a^b f(x) g(x) dx = g(a) \int_a^{\xi} f(x) dx,$$

and when $g(x)$ is monotonic increasing

$$\int_a^b f(x) g(x) dx = g(b) \int_{\xi}^b f(x) dx.$$

1.15.3 Reduction Formulas

1.15.3.1

When, after integration by parts, an integral containing one or more parameters can be expressed in terms of an integral of similar form involving parameters with reduced values, the result is called a **reduction formula (recursion relation)**. Its importance derives from the

fact that it can be used in reverse, because after the simplest form of the integral has been evaluated, the formula can be used to determine more complicated integrals of similar form.

Typical examples of reduction formulas together with an indication of their use follow.

- (a) Given $I_n = \int (1 - x^3)^n dx$, $n = 0, 1, 2, \dots$, integration by parts shows the reduction formula satisfied by I_n to be

$$(3n + 1)I_n = x(1 - x^3)^n + 3nI_{n-1}.$$

Setting $n = 0$ in I_n and omitting the arbitrary constant of integration gives $I_0 = x$. Next, setting $n = 1$ in the reduction formula determines I_1 from $4I_1 = x(1 - x^3) + 3I_0 = 4x - x^4$, so

$$I_1 = x - \frac{1}{4}x^4.$$

I_2 follows by using I_1 in the reduction formula with $n = 2$, while I_3, I_4, \dots , are obtained in similar fashion. Because an indefinite integral is involved, an arbitrary constant must be added to each I_n so obtained to arrive at the most general result.

- (b) Given $I_{m,n} = \int \sin^m x \cos^n x dx$, repeated integration by parts shows the reduction formula satisfied by $I_{m,n}$ to be

$$(m + n)I_{m,n} = \sin^{m+1} x \cos^{n-1} x + (n - 1)I_{m,n-2}.$$

Given $I_n = \int_0^{\pi/2} \cos^n x dx$, repeated integration by parts shows the reduction formula satisfied by I_n to be

$$(c) \quad I_n = \left(\frac{n-1}{n} \right) I_{n-2}.$$

Since $I_0 = \pi/2$ and $I_1 = 1$, this result implies

$$I_{2n} = \left(\frac{2n-1}{2n} \right) \left(\frac{2n-3}{2n-2} \right) \cdots \frac{1}{2} I_0 = \frac{1 \cdot 3 \cdot 5 \cdots (2n-1)}{2 \cdot 4 \cdot 6 \cdots 2n} \cdot \frac{\pi}{2},$$

$$I_{2n+1} = \left(\frac{2n}{2n+1} \right) \left(\frac{2n-2}{2n-1} \right) \cdots \frac{2}{3} I_1 = \frac{2 \cdot 4 \cdot 6 \cdots 2n}{3 \cdot 5 \cdot 7 \cdots (2n+1)}.$$

Combining these results gives

$$\frac{\pi}{2} = \left[\frac{2 \cdot 4 \cdot 6 \cdots 2n}{3 \cdot 5 \cdot 7 \cdots (2n-1)} \right]^2 \left(\frac{1}{2n+1} \right) \frac{I_{2n}}{I_{2n+1}},$$

but

$$\lim_{n \rightarrow \infty} \frac{I_{2n}}{I_{2n+1}} = 1,$$

so we arrive at the Wallis infinite product (see 1.9.2.15)

$$\frac{\pi}{2} = \prod_{k=1}^{\infty} \left(\frac{2k}{2k-1} \right) \left(\frac{2k}{2k+1} \right).$$

1.15.4 Improper Integrals

An **improper integral** is a definite integral that possesses one or more of the following properties:

- (i) the interval of integration is either semi-infinite or infinite in length;
- (ii) the integrand becomes infinite at an interior point of the interval of integration;
- (iii) the integrand becomes infinite at an end point of the interval of integration.

An integral of type (i) is called an **improper integral of the first kind**, while integrals of types (ii) and (iii) are called **improper integrals of the second kind**.

The evaluation of improper integrals.

- I. Let $f(x)$ be defined and finite on the semi-infinite interval $[a, \infty)$. Then the improper integral $\int_a^{\infty} f(x) dx$ is defined as

$$\int_a^{\infty} f(x) dx = \lim_{R \rightarrow \infty} \int_a^R f(x) dx.$$

The improper integral is said to **converge** to the value of this limit when it exists and is finite. If the limit does not exist, or is infinite, the integral is said to **diverge**. Corresponding definitions exist for the improper integrals

$$\int_{-\infty}^a f(x) dx = \lim_{R \rightarrow \infty} \int_{-R}^a f(x) dx,$$

and

$$\int_{-\infty}^{\infty} f(x) dx = \lim_{R_1 \rightarrow \infty} \int_{-R_1}^a f(x) dx + \lim_{R_2 \rightarrow \infty} \int_a^{R_2} f(x) dx, \quad [\text{arbitrary } a],$$

where R_1 and R_2 tend to infinity *independently* of each other.

- II. Let $f(x)$ be defined and finite on the interval $[a, b]$ except at a point ξ interior to $[a, b]$ at which point it becomes infinite. The improper integral $\int_a^b f(x) dx$ is then defined as

$$\int_a^b f(x) dx = \lim_{\varepsilon \rightarrow 0} \int_a^{\xi-\varepsilon} f(x) dx + \lim_{\delta \rightarrow 0} \int_{\xi+\delta}^b f(x) dx,$$

where $\varepsilon > 0$, $\delta > 0$ tend to zero *independently* of each other. The improper integral is said to **converge** when both limits exist and are finite, and its value is then the sum of

the values of the two limits. The integral is said to **diverge** if at least one of the limits is undefined, or is infinite.

- III. Let $f(x)$ be defined and finite on the interval $[a, b]$ except at an end point, say, at $x = a$, where it is infinite. The improper integral $\int_a^b f(x) dx$ is then defined as

$$\int_a^b f(x) dx = \lim_{\varepsilon \rightarrow 0} \int_{a+\varepsilon}^b f(x) dx,$$

where $\varepsilon > 0$. The improper integral is said to **converge** to the value of this limit when it exists and is finite. If the limit does not exist, or is infinite, the integral is said to **diverge**. A corresponding definition applies when $f(x)$ is infinite at $x = b$.

- IV. It may happen that although an improper integral of type (i) is divergent, modifying the limits in I by setting $R_1 = R_2 = R$ gives rise to a finite result. This is said to define the **Cauchy principal** value of the integral, and it is indicated by inserting the letters PV before the integral sign. Thus, when the limit is finite,

$$\text{PV} \int_{-\infty}^{\infty} f(x) dx = \lim_{R \rightarrow \infty} \int_{-R}^R f(x) dx.$$

Similarly, it may happen that although an improper integral of type (ii) is divergent, modifying the limits in II by setting $\varepsilon = \delta$, so the limits are evaluated *symmetrically* about $x = \xi$, gives rise to a finite result. This also defines a Cauchy principal value, and when the limits exist and are finite, we have

$$\text{PV} \int_a^b f(x) dx = \lim_{\varepsilon \rightarrow 0} \left\{ \int_a^{\xi-\varepsilon} f(x) dx + \int_{\xi+\varepsilon}^b f(x) dx \right\}.$$

When an improper integral converges, its value and the Cauchy principal value coincide. Typical examples of improper integrals are:

$$\begin{aligned} \int_0^{\infty} x e^{-x} dx &= 1, & \int_1^{\infty} \frac{dx}{1+x^2} &= \frac{\pi}{4}, \\ \int_0^2 \frac{dx}{(x-1)^{2/3}} &= 6, & \int_0^1 \frac{dx}{\sqrt{1-x^2}} &= \frac{\pi}{2}, \\ \int_0^{\infty} \sin x dx &\text{ diverges,} & \text{PV} \int_{-\infty}^{\infty} \frac{\cos x}{a^2 - x^2} dx &= \frac{\pi}{a} \sin a. \end{aligned}$$

Convergence tests for improper integrals.

- Let $f(x)$ and $g(x)$ be continuous on the semi-infinite interval $[a, \infty)$, and let $g'(x)$ be continuous and monotonic decreasing on this same interval. Suppose

- (i) $\lim_{x \rightarrow \infty} g(x) = 0$,

- (ii) $F(x) = \int_a^x f(x) dx$ is bounded on $[a, \infty)$, so that for some $M > 0$,
 $|F(x)| < M$ for $a \leq x < \infty$,

then the improper integral

$$\int_a^\infty f(x) g(x) dx$$

converges.

(Abel's test)

2. Let $f(x)$ and $g(x)$ be continuous in the semi-infinite interval $[a, \infty)$, and let $g'(x)$ be continuous in this same interval. Suppose also that

- (i) $\lim_{x \rightarrow \infty} g(x) = 0$,
 (ii) $\int_a^\infty |g'(x)| dx$ converges,
 (iii) $F(k) = \int_a^k f(x) dx$ is bounded on $[a, k]$ such that for some $M > 0$,
 $|F(k)| < M$ for all $k > a$,

then

$$\int_a^\infty f(x) g(x) dx$$

converges.

(Dirichlet's test)

1.15.5 Integration of Rational Functions

A partial fraction decomposition of a rational function $N(x)/D(x)$ (see 1.72) reduces it to a sum of terms of the type:

- (a) a polynomial $P(x)$ when the degree of $N(x)$ equals or exceeds the degree of $D(x)$;
 (b) $\frac{A}{a + bx}$,
 (c) $\frac{B}{(a + bx)^m}$ [$m > 1$ an integer],
 (d) $\frac{Cx + D}{(a + bx + cx^2)^n}$ [$n \geq 1$ an integer].

Integration of these simple rational functions gives:

- (a') If $P(x) = a_0 + a_1x + \cdots + a_r x^r$, then
 $\int P(x) dx = a_0x + 1/2a_1x^2 + \cdots + \frac{1}{(r+1)}a_r x^{r+1} + \text{const.},$
 (b') $\int \frac{A}{a + bx} dx = \left(\frac{A}{b}\right) \ln |a + bx| + \text{const.},$
 (c') $\int \frac{B}{(a + bx)^m} dx = \left(\frac{B}{b}\right) \left(\frac{1}{1-m}\right) (a + bx)^{1-m} + \text{const.} \quad [m > 1],$

(d') $\int \frac{Cx + D}{(a + bx + cx^2)^n} dx$ should be reexpressed as

$$\int \frac{Cx + D}{(a + bx + cx^2)^n} dx = \left(\frac{C}{2c}\right) \int \frac{b + 2cx}{(a + bx + cx^2)^n} dx + \left(D - \frac{Cb}{2c}\right) \int \frac{dx}{(a + bx + cx^2)^n}.$$

Then,

- (i) $\int \frac{b + 2cx}{(a + bx + cx^2)} dx = \ln |a + bx + cx^2| + \text{const.} \quad [n = 1],$
- (ii) $\int \frac{b + 2cx}{(a + bx + cx^2)} dx = \frac{-1}{(n - 1)} \frac{1}{(a + bx + cx^2)^{n-1}} + \text{const.} \quad [n > 1],$
- (iii) $\int \frac{dx}{(a + bx + cx^2)} = \frac{1}{c} \int \frac{dx}{[x + b/(2c)]^2 + [a/c - b^2/(4c^2)]} \quad [n = 1],$

where the integral on the right is a standard integral. When evaluated, the result depends on the sign of $\Delta = 4ac - b^2$. If $\Delta > 0$ integration yields an inverse tangent function (see 4.2.5.1.1), and if $\Delta < 0$ it yields a logarithmic function or, equivalently, an inverse hyperbolic tangent function (see 4.2.5.1.1). If $\Delta = 0$, integration of the right-hand side gives $-2/(b + 2cx) + \text{const.}$

- (iv) $\int \frac{dx}{(a + bx + cx^2)^n} \quad [n > 1 \text{ an integer}].$

This integral may be evaluated by using result (iii) above in conjunction with the reduction formula

$$I_n = \frac{b + 2cx}{(n - 1)(4ac - b^2)D^{n-1}} + \frac{2(2n - 3)c}{(n - 1)(4ac - b^2)} I_{n-1},$$

where

$$D = a + bx + cx^2 \quad \text{and} \quad I_n = \int \frac{dx}{(a + bx + cx^2)^n}.$$

1.15.6 Elementary Applications of Definite Integrals

1.15.6.1

The elementary applications that follow outline the use of definite integrals for the determination of areas, arc lengths, volumes, centers of mass, and moments of inertia.

Area under a curve. The definite integral

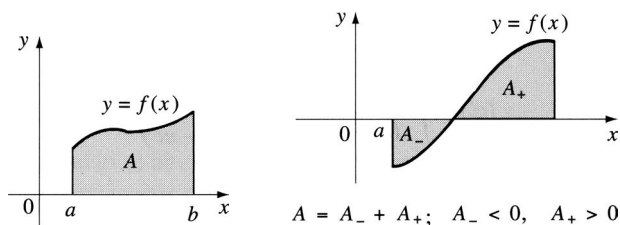

$$1. \quad A = \int_a^b f(x) dx$$

may be interpreted as the algebraic sum of areas above and below the x -axis that are bounded by the curve $y = f(x)$ and the lines $x = a$ and $x = b$, with areas above the x -axis assigned positive values and those below it negative values.

Volume of revolution.

(i) Let $f(x)$ be a continuous and nonnegative function defined on the interval $a \leq x \leq b$, and A be the area between the curve $y = f(x)$, the x -axis, and the lines $x = a$ and $x = b$. Then the volume of the solid generated by rotating A about the x -axis is

$$2. \quad V = \pi \int_a^b [f(x)]^2 dx.$$

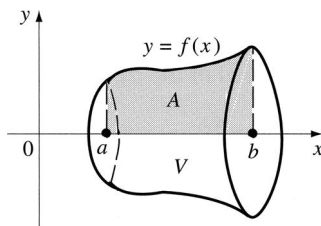

(ii) Let $g(y)$ be a continuous and nonnegative function defined on the interval $c \leq y \leq d$, and A be the area between the curve $x = g(y)$, the y -axis, and the lines $y = c$ and $y = d$. Then the volume of the solid generated by rotating A about the y -axis is

$$3. \quad V = \pi \int_c^d [g(y)]^2 dy.$$

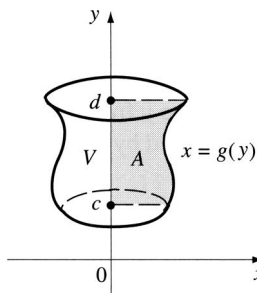

- (iii) Let $g(y)$ be a continuous and nonnegative function defined on the interval $c \leq y \leq d$ with $c \geq 0$, and A be the area between the curve $x = g(y)$, the y -axis, and the lines $y = c$ and $y = d$. Then the volume of the solid generated by rotating A about the x -axis is.

$$4. \quad V = 2\pi \int_c^d yg(y) dy.$$

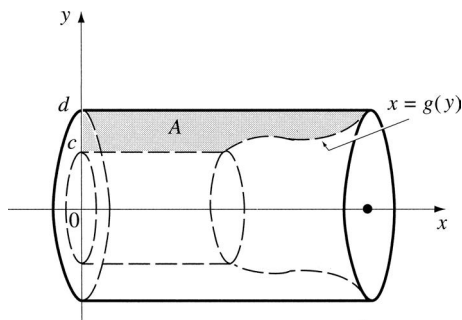

- (iv) Let $f(x)$ be a continuous and nonnegative function defined on the interval $a \leq x \leq b$ with $a \geq 0$, and A be the area between the curve $y = f(x)$, the x -axis, and the lines $x = a$ and $x = b$. Then the volume of the solid generated by rotating A about the y -axis is

$$5. \quad V = 2\pi \int_a^b xf(x) dx.$$

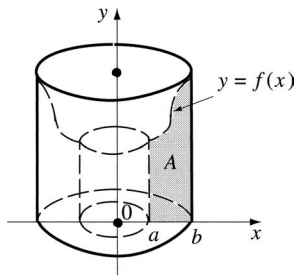

(v) **Theorem of Pappus**

Let a closed curve C in the (x, y) -plane that does not intersect the x -axis have a circumference L and area A , and let its centroid be at a perpendicular distance \bar{y} from the x -axis. Then the surface area S and volume V of the solid generated by rotating the area within the curve C about the x -axis are given by

$$6. \quad S = 2\pi\bar{y}L \quad \text{and} \quad V = 2\pi\bar{y}A.$$

Length of an arc.

- (i) Let $f(x)$ be a function with a continuous derivative that is defined on the interval $a \leq x \leq b$. Then the length of the arc along $y = f(x)$ from $x = a$ to $x = b$ is

$$7. \quad s = \int_a^b \sqrt{1 + [f'(x)]^2} dx,$$

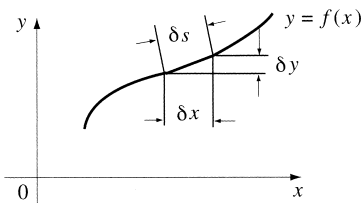

$$\delta s^2 = \delta x^2 + \delta y^2; \text{ in the limit } \left(\frac{ds}{dx}\right)^2 = 1 + \left(\frac{dy}{dx}\right)^2 = 1 + [f'(x)]^2$$

- (ii) Let $g(y)$ be a function with a continuous derivative that is defined on the interval $c \leq y \leq d$. Then the length of the arc along $x = g(y)$ from $y = c$ to $y = d$ is

$$8. \quad s = \int_c^d \sqrt{1 + [g'(y)]^2} dy.$$

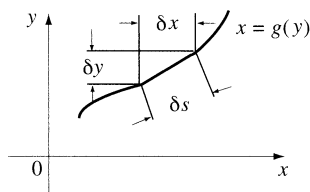

$$\delta s^2 = \delta y^2 + \delta x^2; \text{ in the limit } \left(\frac{ds}{dy}\right)^2 = 1 + \left(\frac{dx}{dy}\right)^2 = 1 + [g'(y)]^2$$

Area of surface of revolution.

- (i) Let $f(x)$ be a nonnegative function with a continuous derivative that is defined on the interval $a \leq x \leq b$. Then the area of the surface of revolution generated by rotating the curve $y = f(x)$ about the x -axis between the planes $x = a$ and $x = b$ is

$$9. \quad S = 2\pi \int_a^b f(x) \sqrt{1 + [f'(x)]^2} dx. \quad (\text{see also Pappus's theorem 1.15.6.1.5})$$

- (ii) Let $g(y)$ be a nonnegative function with a continuous derivative that is defined on the interval $c \leq y \leq d$. Then the area of the surface generated by rotating the curve $x = g(y)$ about the y -axis between the planes $y = c$ and $y = d$ is

$$10. \quad S = 2\pi \int_c^d g(y) \sqrt{1 + [g'(y)]^2} dy.$$

Center of mass and moment of inertia.

- (i) Let a plane lamina in a region R of the (x, y) -plane within a closed plane curve C have the continuous mass density distribution $\rho(x, y)$. Then the **center of mass (gravity)** of the lamina is located at the point G with coordinates (\bar{x}, \bar{y}) , where

$$11. \quad \bar{x} = \frac{\iint_R x\rho(x,y) dA}{M}, \quad \bar{y} = \frac{\iint_R y\rho(x,y) dA}{M},$$

with dA the element of area in R and

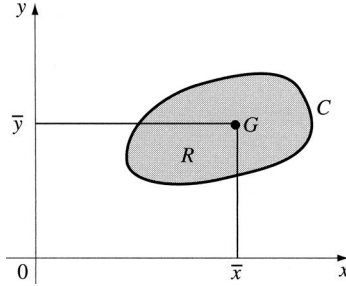

$$12. \quad M = \iint_R \rho(x,y) dA. \quad \text{(mass of lamina)}$$

When this result is applied to the area R within the plane curve C in the (x, y) -plane, which may be regarded as a lamina with a uniform mass density that may be taken to be $\rho(x, y) \equiv 1$, the center of mass is then called the **centroid**.

(ii) The **moments of inertia** of the lamina in (i) about the x -, y -, and z -axes are given, respectively, by

$$13. \quad I_x = \iint_R y^2 \rho(x,y) dA,$$

$$I_y = \iint_R x^2 \rho(x,y) dA$$

$$I_z = \iint_R (x^2 + y^2) \rho(x,y) dA.$$

The **radius of gyration** of a body about an axis L denoted by k_L is defined as

$$14. \quad k_L^2 = I_L/M,$$

where I_L is the moment of inertia of the body about the axis L and M is the mass of the body.

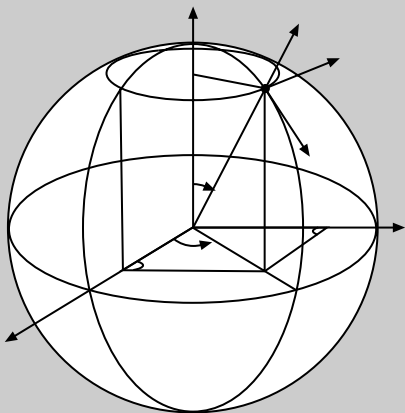

Chapter 2

Functions and Identities

2.1 COMPLEX NUMBERS AND TRIGONOMETRIC AND HYPERBOLIC FUNCTIONS

2.1.1 Basic Results

2.1.1.1 Modulus-Argument Representation

In the modulus-argument (r, θ) representation of the complex number $z = x + iy$, located at a point P in the complex plane, r is the radial distance of P from the origin and θ is the angle measured from the positive real axis to the line OP . The number r is called the **modulus** of z (see 1.1.1.1), and θ is called the **argument** of z , written $\arg z$, and it is chosen to lie in the interval

- $-\pi < \theta \leq \pi$.

By convention, $\theta = \arg z$ is measured *positively* in the counterclockwise sense from the positive real axis, so that $0 \leq \theta \leq \pi$, and *negatively* in the clockwise sense from the positive real axis, so that $-\pi < \theta \leq 0$. Thus,

- $z = x + iy = r \cos \theta + ir \sin \theta$

or

- $z = r(\cos \theta + i \sin \theta)$.

The connection between the **Cartesian representation** $z = x + iy$ and the modulus-argument form is given by

- $x = r \cos \theta, \quad y = r \sin \theta$

- $r = (x^2 + y^2)^{1/2}$.

The periodicity of the sine and cosine functions with period 2π means that for given r and θ , the complex number z in 2.1.1.1.3 will be unchanged if $\theta = \arg z$ is replaced by

$\theta \pm 2k\pi, k = 0, 1, 2, \dots$. This ambiguity in $\arg z$, which is, in fact, a *set* of values, is removed by constraining θ to satisfy 2.1.1.1.1. When $\arg z$ is chosen in this manner, and z is given by 2.1.1.1.3, θ is called the **principal value** of the argument of z .

Examples of modulus and argument representation follow:

- (i) $z = 1 + i, \quad r = 2^{1/2}, \quad \theta = \arg z = \pi/4$
- (ii) $z = 1 - i\sqrt{3}, \quad r = 2, \quad \theta = \arg z = -\pi/3$
- (iii) $z = -2 - 2i, \quad r = 2^{3/2}, \quad \theta = \arg z = -3\pi/4$
- (iv) $z = -2\sqrt{3} + 2i, \quad r = 4, \quad \theta = \arg z = 5\pi/6$

2.1.1.2 Euler's Formula and de Moivre's Theorem

1. $e^{i\theta} = \cos \theta + i \sin \theta,$ **(Euler's formula)**
so an arbitrary complex number can always be written in the form
2. $z = re^{i\theta}$
3. $(\cos \theta + i \sin \theta)^n = \cos n\theta + i \sin n\theta.$ **(de Moivre's theorem)**

Some special complex numbers in modulus-argument form:

$$1 = e^{2k\pi i} \quad [k = 0, 1, 2, \dots], \quad -1 = e^{(2k+1)\pi i} \quad [k = 0, 1, \dots]$$

$$i = e^{\pi i/2}, \quad -i = e^{3\pi i/2}.$$

Euler's formula and de Moivre's theorem may be used to establish trigonometric identities. For example, from the Euler formula, 2.1.1.2.1,

$$\cos \theta = \frac{1}{2} (e^{i\theta} + e^{-i\theta}),$$

so

$$\begin{aligned} \cos^5 \theta &= \left(\frac{e^{i\theta} + e^{-i\theta}}{2} \right)^5 \\ &= \frac{1}{32} (e^{5i\theta} + 5e^{3i\theta} + 10e^{i\theta} + 10e^{-i\theta} + 5e^{-3i\theta} + e^{-5i\theta}) \\ &= \frac{1}{16} \left[\left(\frac{e^{5i\theta} + e^{-5i\theta}}{2} \right) + 5 \left(\frac{e^{3i\theta} + e^{-3i\theta}}{2} \right) + 10 \left(\frac{e^{i\theta} + e^{-i\theta}}{2} \right) \right] \\ &= \frac{1}{16} (\cos 5\theta + 5 \cos 3\theta + 10 \cos \theta), \end{aligned}$$

which expresses $\cos^5 \theta$ in terms of multiple angles.

A similar argument using

$$\sin \theta = \frac{e^{i\theta} - e^{-i\theta}}{2i}$$

shows that, for example,

$$\sin^4 \theta = \frac{1}{8} (\cos 4\theta - 4 \cos 2\theta + 3),$$

which expresses $\sin^4 \theta$ in terms of multiple angles (see 2.4.1.7.3).

Sines and cosines of multiple angles may be expressed in terms of powers of sines and cosines by means of de Moivre's theorem, 2.1.1.2.3. For example, setting $n = 5$ in the theorem gives

$$(\cos \theta + i \sin \theta)^5 = \cos 5\theta + i \sin 5\theta$$

or

$$\begin{aligned} &(\cos^5 \theta - 10 \sin^2 \theta \cos^3 \theta + 5 \sin^4 \theta \cos \theta) \\ &+ i (5 \sin \theta \cos^4 \theta - 10 \sin^3 \theta \cos^2 \theta + \sin^5 \theta) = \cos 5\theta + i \sin 5\theta. \end{aligned}$$

Equating the respective real and imaginary parts of this identity gives

$$\begin{aligned} \cos 5\theta &= \cos^5 \theta - 10 \sin^2 \theta \cos^3 \theta + 5 \sin^4 \theta \cos \theta, \\ \sin 5\theta &= 5 \sin \theta \cos^4 \theta - 10 \sin^3 \theta \cos^2 \theta + \sin^5 \theta. \end{aligned}$$

These identities may be further simplified by using $\cos^2 \theta + \sin^2 \theta = 1$ to obtain

$$\cos 5\theta = 16 \cos^5 \theta - 20 \cos^3 \theta + 5 \cos \theta$$

and

$$\sin 5\theta = 5 \sin \theta - 20 \sin^3 \theta + 16 \sin^5 \theta.$$

2.1.1.3 Roots of a Complex Number

Let $w^n = z$, with n an integer, so that $w = z^{1/n}$. Then, if $w = \rho e^{i\phi}$ and $z = r e^{i\theta}$,

$$1. \quad \rho = r^{1/n}, \quad \phi_k = \frac{\theta + 2k\pi}{n}, \quad [k = 0, 1, \dots, n-1],$$

so the n roots of z are

$$2. \quad w_k = r^{1/n} \left[\cos \left(\frac{\theta + 2k\pi}{n} \right) + i \sin \left(\frac{\theta + 2k\pi}{n} \right) \right] \quad [k = 0, 1, \dots, n-1].$$

When $z = 1$, the n roots of $z^{1/n}$ are called the **n 'th roots of unity**, and are usually denoted by $\omega_0, \omega_1, \dots, \omega^{n-1}$, where

$$3. \quad \omega_k = e^{2k\pi i/n} \quad [k = 0, 1, \dots, n-1].$$

Example of roots of a complex number. If $w^4 = -2\sqrt{3} + 2i$, so $w = (-2\sqrt{3} + 2i)^{1/4}$, if we set $z = -2\sqrt{3} + 2i$ it follows that $r = |z| = 4$ and $\theta = \arg z = 5\pi/6$. So, from 2.1.1.3.2, the required fourth roots of z are

$$w_k = 2^{1/2} \left[\cos \left(\frac{5 + 12k}{24} \right) \pi + i \sin \left(\frac{5 + 12k}{24} \right) \pi \right] \quad [k = 0, 1, 2, 3].$$

Some special roots:

$$w^2 = i, \text{ or } w = \sqrt{i} \text{ has the two complex roots } (-1 + i)/\sqrt{2} \text{ and } -(1 + i)/\sqrt{2},$$

$$w^2 = -i, \text{ or } w = \sqrt{-i} \text{ has the two complex roots } (1 - i)/\sqrt{2} \text{ and } -(1 - i)/\sqrt{2},$$

$$w^3 = i, \text{ or } w = i^{1/3} \text{ has the three complex roots } -i, -(\sqrt{3} + i)/2 \text{ and } (\sqrt{3} + i)/2,$$

$$w^3 = -i, \text{ or } w = (-i)^{1/3} \text{ has the three complex roots } i, -(\sqrt{3} + i)/2 \text{ and } (\sqrt{3} - i)/2.$$

The Quadratic Formula

Consider the quadratic function $ax^2 + bx + c$ with real coefficients. Completing the square, this becomes

$$ax^2 + bx + c = a \left(x + \frac{b}{2a} \right)^2 + c - \frac{b^2}{4a},$$

so the quadratic equation $ax^2 + bx + c = 0$ can be rewritten as

$$1. \quad a \left(x + \frac{b}{2a} \right)^2 = \frac{b^2}{4a} - c.$$

In this form the equation can be solved for x , but two cases must be considered.

Case 1: When $b^2 - 4ac \geq 0$, the two roots are real and given by the familiar **quadratic formula**

$$2. \quad x = \frac{-b \pm \sqrt{b^2 - 4ac}}{2a},$$

where the positive square root of a real number $p > 0$ is denoted by \sqrt{p} .

Case 2: When $b^2 - 4ac < 0$, we must replace $\sqrt{b^2 - 4ac}$ by $i\sqrt{4ac - b^2}$, from which it then follows that the two roots are complex conjugates given by

$$3. \quad x = \frac{-b \pm i\sqrt{4ac - b^2}}{2a}.$$

In the more general case, finding the two roots when the coefficients a , b , and c are complex is accomplished by first writing the equation as in 1 and then using **2.1.1.3** to find the two roots w_1 and w_2 of $\left(\frac{b^2 - 4ac}{4a^2} \right)^{1/2}$. The required roots then follow by solving for x the equations $x + b/(2a) = w_1$ and $x + b/(2a) = w_2$.

Example: Find the roots of $(1 + i)x^2 + x + 1 = 0$.

Here $a = 1 + i$, $b = 1$, $c = 1$, so $(b^2 - 4ac)/4a^2 = -\frac{1}{2} + \frac{3}{8}i$, and the two square roots of $-\frac{1}{2} + \frac{3}{8}i$ are $w_1 = \frac{1}{4}(1 + 3i)$ and $w_2 = -\frac{1}{4}(1 + 3i)$. So the required roots x_1 and x_2 of the quadratic equation are $x_1 = w_1 - b/(2a) = i$ and $x_2 = w_2 - b/(2a) = -\frac{1}{2}(1 + i)$.

Cardano Formula for the Roots of a Cubic

Given the cubic

$$x^3 + Ax^2 + Bx + C = 0,$$

the substitution $x = y - \frac{1}{3}A$ reduces it to a cubic of the form

$$y^3 + ay + b = 0.$$

Setting

$$p = \left(-\frac{1}{2}b + d\right)^{1/3} \quad \text{and} \quad q = \left(-\frac{1}{2}b - d\right)^{1/3},$$

where d is the positive square root

$$d = \sqrt{\left(\frac{1}{3}a\right)^3 + \left(\frac{1}{2}b\right)^2}, \text{ the Cardano formulas for the roots } x_1, x_2, \text{ and } x_3 \text{ are}$$

$$x_1 = p + q - \frac{1}{3}A, \quad x_2 = -\frac{1}{2}(p + q) - \frac{1}{3}A + \frac{1}{2}(p - q)i\sqrt{3},$$

$$x_3 = -\frac{1}{2}(p + q) - \frac{1}{3}A - \frac{1}{2}(p - q)i\sqrt{3}$$

2.1.1.4 Relationship Between Roots

Once a root w_* of $w^n = z$ has been found for a given z and integer n , so that $w_* = z^{1/n}$ is one of the n 'th roots of z , the other $n-1$ roots are given by $w.w_1, w.w_2, \dots, w.w_{n-1}$, where the w_k are the n 'th roots of unity defined in 2.1.1.3.3.

2.1.1.5 Roots of Functions, Polynomials, and Nested Multiplication

If $f(x)$ is an arbitrary function of x , a number x_0 such that $f(x_0) = 0$ is said to be a **root** of the function or, equivalently, a **zero** of $f(x)$. The need to determine a root of a function $f(x)$ arises frequently in mathematics, and when it cannot be found analytically it becomes necessary to make use of numerical methods.

In the special case in which the function is the **polynomial of degree n**

$$1. \quad P_n(x) \equiv a_0x^n + a_1x^{n-1} + \dots + a_n,$$

with the **coefficients** a_0, a_1, \dots, a_n , it follows from the *fundamental theorem of algebra* that $P_n(x) = 0$ has n roots x_1, x_2, \dots, x_n , although these are not necessarily all real or distinct. If x_i is a root of $P_n(x) = 0$ then $(x - x_i)$ is a factor of the polynomial and it can be expressed as

$$2. \quad P_n(x) \equiv a_0(x - x_1)(x - x_2)\cdots(x - x_n).$$

If a root is repeated m times it is said to have **multiplicity m** .

The important **division algorithm** for polynomials asserts that if $P(x)$ and $Q(x)$ are polynomials with the respective degrees n and m , where $1 \leq m \leq n$, then a polynomial $R(x)$ of degree $n-m$ and a polynomial $S(x)$ of degrees $m-1$ or less, both of which are unique, can be found such that

$$P(x) = Q(x)R(x) + S(x).$$

Polynomials in which the coefficients a_0, a_1, \dots, a_n are real numbers have the following special properties, which are often of use:

- (i) If the degree n of $P_n(x)$ is odd it has at least one real root.
- (ii) If a root z of $P_n(x)$ is complex, then its complex conjugate \bar{z} is also a root. The quadratic expression $(x-z)(x-\bar{z})$ has *real* coefficients, and is a factor of $P_n(x)$.
- (iii) $P_n(x)$ may always be expressed as a product of real linear and quadratic factors with real coefficients, although they may occur with a multiplicity greater than unity.

The following numerical methods for the determination of the roots of a function $f(x)$ are arranged in order of increasing speed or convergence.

The bisection method. The **bisection method**, which is the most elementary method for the location of a root of $f(x) = 0$, is based on the *intermediate value theorem*. The theorem asserts that if $f(x)$ is continuous on the interval $a \leq x \leq b$, with $f(a)$ and $f(b)$ of opposite signs, then there will be at least one value $x = c$, strictly intermediate between a and b , such that $f(c) = 0$. The method, which is iterative, proceeds by repeated bisection of intervals containing the required root, which after each bisection the subinterval that contains the root forms the interval to be used in the next bisection. Thus the root is bracketed in a nested set of intervals I_0, I_1, I_2, \dots , where $I_0 = [a, b]$, and after the n 'th bisection the interval I_n is of length $(b-a)/2^n$. The method is illustrated in Figure 2.1.

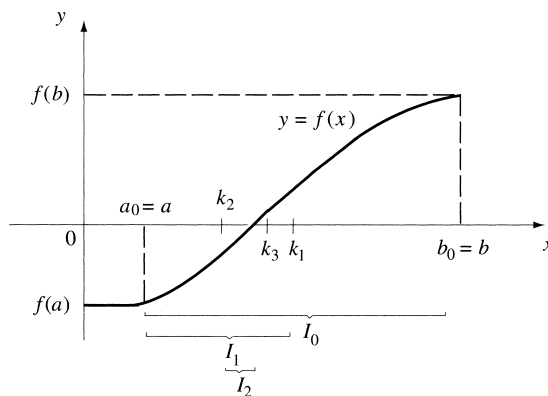

Figure 2.1.

The bisection algorithm

Step 1. Find the numbers a_0, b_0 such that $f(a_0)$ and $f(b_0)$ are of opposite sign, so that $f(x)$ has at least one root in the interval $I_0 = [a_0, b_0]$.

Step 2. Starting from Step 1, construct a new interval $I_{n+1} = [a_{n+1}, b_{n+1}]$ from interval $I_n = [a_n, b_n]$ by setting

$$3. \quad k_{n+1} = a_n + \frac{1}{2}(b_n - a_n)$$

and choosing

$$4. \quad a_{n+1} = a_n, \quad b_{n+1} = k_{n+1} \quad \text{if } f(a_n)f(k_{n+1}) < 0$$

and

$$5. \quad a_{n+1} = k_{n+1}, \quad b_{n+1} = b_n \quad \text{if } f(a_n)f(k_{n+1}) > 0.$$

Step 3. Terminate the iteration when one of the following conditions is satisfied:

- (i) For some $n = N$, the number k_N is an exact root of $f(x)$, so $f(k_N) = 0$.
- (ii) Take k_N as the approximation to the required root if, for some $n = N$ and some preassigned error bound $\varepsilon > 0$, it follows that $|k_N - k_{N-1}| < \varepsilon$.

To avoid excessive iteration caused by round-off error interfering with a small error bound ε it is necessary to place an upper bound M on the total number of iterations to be performed. In the bisection method the number M can be estimated by using $M > \log_2 \left(\frac{b-a}{\varepsilon} \right)$.

The convergence of the bisection method is slow relative to other methods, but it has the advantage that it is *unconditionally convergent*. The bisection method is often used to determine a starting approximation for a more sophisticated and rapidly convergent method, such as Newton's method, which can diverge if a poor approximation is used.

The method of false position (regula falsi). The **method of false position**, also known as the **regula falsi method**, is a bracketing technique similar to the bisection method, although the nesting of the intervals I_n within which the root of $f(x) = 0$ lies is performed differently. The method starts as in the bisection method with two numbers a_0, b_0 and the interval $I_0 = [a_0, b_0]$ such that $f(a_0)$ and $f(b_0)$ are of opposite signs. The starting approximation to the required root in I_0 is taken to be the point k_0 at which the chord joining the points $(a_0, f(a_0))$ and $(b_0, f(b_0))$ cuts the x -axis. The interval I_0 is then divided into the two subintervals $[a_0, k_0]$ and $[k_0, b_0]$, and the interval I_1 is chosen to be the subinterval at the ends of which $f(x)$ has opposite signs.

Thereafter, the process continues iteratively until, for some $n = N$, $|k_N - k_{N-1}| < \varepsilon$, where $\varepsilon > 0$ is a preassigned error bound. The approximation to the required root is taken to be k_N . The method is illustrated in Figure 2.2.

The false position algorithm

Step 1. Find two numbers a_0, b_0 such that $f(a_0)$ and $f(b_0)$ are of opposite signs, so that $f(x)$ has at least one root in the interval $I_0 = [a_0, b_0]$.

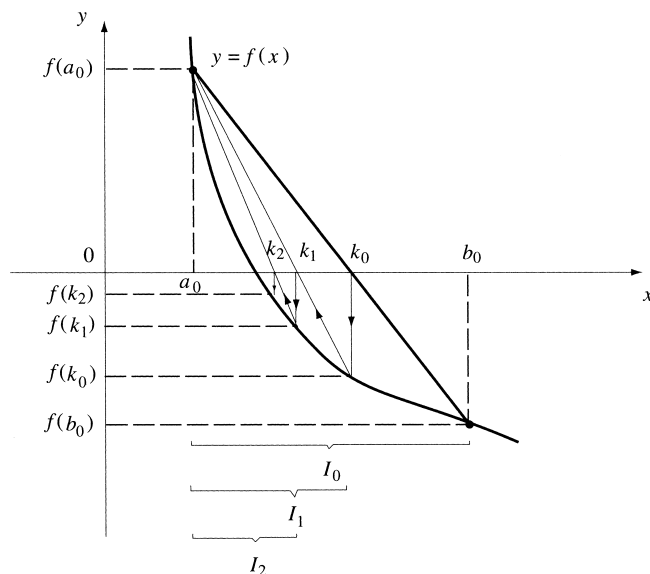

Figure 2.2.

Step 2. Starting from Step 1, construct a new interval $I_{n+1} = [a_{n+1}, b_{n+1}]$ from the interval $I_n = [a_n, b_n]$ by setting

$$6. \quad k_{n+1} = a_n - \frac{f(a_n)(b_n - a_n)}{f(b_n) - f(a_n)}$$

and choosing

$$7. \quad a_{n+1} = a_n, \quad b_{n+1} = k_{n+1} \quad \text{if } f(a_n)f(k_{n+1}) < 0$$

or

$$8. \quad a_{n+1} = k_{n+1}, \quad b_{n+1} = b_n \quad \text{if } f(a_n)f(k_{n+1}) > 0.$$

Step 3. Terminate the iterations if either, for some $n = N$, k_N is an exact root so that $f(k_N) = 0$, or for some preassigned error bound $\varepsilon > 0$, $|k_N - k_{N-1}| < \varepsilon$, in which case k_N is taken to be the required approximation to the root. It is necessary to place an upper bound M on the total number of iterations N to prevent excessive iteration that may be caused by round-off errors interfering with a small error bound ε .

The secant method. Unlike the previous methods, the **secant method** does *not* involve bracketing a root of $f(x) = 0$ in a sequence of nested intervals. Thus the convergence of the secant method cannot be guaranteed, although when it does converge the process is usually faster than either of the two previous methods.

The secant method is started by finding two approximations k_0 and k_1 to the required root of $f(x) = 0$. The next approximation k_2 is taken to be the point at which the secant drawn

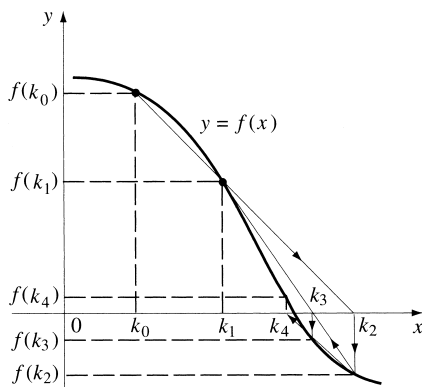

Figure 2.3.

through the points through the points $(k_0, f(k_0))$ and $(k_1, f(k_1))$ cuts the x -axis. Thereafter, iteration takes place with secants drawn as shown in Figure 2.3.

The secant algorithm. Starting from the approximation k_0, k_1 to the required root of $f(x) = 0$, the approximation k_{n+1} is determined from the approximations k_n and k_{n-1} by using

$$9. \quad k_{n+1} = k_n - \frac{f(k_n)(k_n - k_{n-1})}{f(k_n) - f(k_{n-1})}.$$

The iteration is terminated when, for some $n = N$ and a preassigned error bound $\varepsilon > 0$, $|k_N - k_{N-1}| < \varepsilon$. An upper bound M must be placed on the number of iterations N in case the method diverges, which occurs when $|k_N|$ increases without bound.

Newton's method. **Newton's method**, often called the **Newton–Raphson method**, is based on a tangent line approximation to the curve $y = f(x)$ at an approximate root x_0 of $f(x) = 0$. The method may be deduced from a Taylor series approximation to $f(x)$ about the point x_0 as follows. Provided $f(x)$ is differentiable, then if $x_0 + h$ is an exact root,

$$0 = f(x_0 + h) = f(x_0) + hf'(x_0) + \frac{h^2}{2!}f''(x_0) + \cdots.$$

Thus, if h is sufficiently small that higher powers of h may be neglected, an approximate value h_0 to h is given by

$$h_0 = -\frac{f(x_0)}{f'(x_0)},$$

and so a better approximation to x_0 is $x_1 = x_0 + h_0$. This process is iterated until the required accuracy is attained. However, a poor choice of the starting value x_0 may cause the method to diverge. The method is illustrated in Figure 2.4.

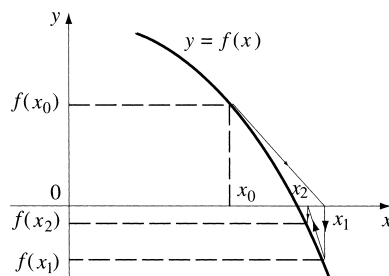

Figure 2.4.

The Newton algorithm. Starting from an approximation x_0 to the required root of $f(x) = 0$, the approximation x_{n+1} is determined from the approximation x_n by using

$$10. \quad x_{n+1} = x_n - \frac{f(x)}{f'(x_n)}.$$

The iteration is terminated when, for some $n = N$ and a preassigned error bound $\varepsilon > 0$, $|x_N - x_{N-1}| < \varepsilon$. An upper bound M must be placed on the number of iterations N in case the method diverges.

Notice that the secant method is an approximation to Newton's method, as can be seen by replacing the derivative $f'(x_n)$ in the above algorithm with a difference quotient.

Newton's algorithm—two equations and two unknowns

The previous method extends immediately to the case of two simultaneous equations in two unknowns x and y

$$f(x, y) = 0 \quad \text{and} \quad g(x, y) = 0,$$

for which x^* and y^* are required, such that $f(x^*, y^*) = 0$ and $g(x^*, y^*) = 0$. In this case the iterative process starts with an approximation (x_0, y_0) close to the required solution, and the $(n + 1)$ th iterates (x_{n+1}, y_{n+1}) are found from the n th iterates (x_n, y_n) by means of the formulas

$$11. \quad x_{n+1} = x_n - \left[\frac{f \partial g / \partial y - g \partial f / \partial y}{\partial f / \partial x \partial g / \partial y - \partial f / \partial y \partial g / \partial x} \right]_{(x_n, y_n)}$$

$$y_{n+1} = y_n - \left[\frac{g \partial f / \partial x - f \partial g / \partial x}{\partial f / \partial x \partial g / \partial y - \partial f / \partial y \partial g / \partial x} \right]_{(x_n, y_n)}.$$

The iterations are terminated when, for some $n = N$ and a preassigned error bound $\varepsilon > 0$, $|x_N - x_{N+1}| < \varepsilon$ and $|y_N - y_{N+1}| < \varepsilon$. As in the one variable case, an upper bound M must be placed on the number of iterations N to terminate the algorithm if it diverges, in which case a better starting approximation (x_0, y_0) must be used.

Nested multiplication. When working with polynomials in general, or when using them in conjunction with one of the previous root-finding methods, it is desirable to have an efficient method for their evaluation for specific arguments. Such a method is provided by the technique of **nested multiplication**.

Consider, for example, the quartic

$$P_4(x) \equiv 3x^4 + 2x^3 - 4x^2 + 5x - 7.$$

Then, instead of evaluating each term of $P_4(x)$ separately for some $x = c$, say, and summing them to find $P_4(c)$, fewer multiplications are required if $P_4(x)$ is rewritten in the **nested form**:

$$P_4(x) \equiv x\{x[x(3x+2) - 4] + 5\} - 7.$$

When repeated evaluation of polynomials is required, as with root-finding methods, this economy of multiplication becomes significant.

Nested multiplication is implemented on a computer by means of the simple algorithm given below, which is based on the division algorithm for polynomials, and for this reason the method is sometimes called **synthetic division**.

The nested multiplication algorithm for evaluating $P_n(c)$. Suppose we want to evaluate the polynomial

$$12. \quad P_n(x) = a_0x^n + a_1x^{n-1} + \cdots + a_n$$

for some $x = c$. Set $b_0 = a_0$, and generate the sequence b_1, b_2, \dots, b_n by means of the algorithm

$$13. \quad b_i = cb_{i-1} + a_i, \quad \text{for } 1 \leq i \leq n;$$

then

$$14. \quad P_n(c) = b_n.$$

The argument that led to the nested multiplication algorithm for the evaluation of $P_n(c)$ also leads to the following algorithm for the evaluation of $P'_n(c) = [dP_n(x)/dx]_{x=c}$. These algorithms are useful when applying Newton's method to polynomials because all we have to store is the sequence b_0, b_1, \dots, b_n .

Algorithm for evaluating $P'_n(c)$. Suppose we want to evaluate $P'_n(x)$ when $x = c$, where $P_n(x)$ is the polynomial in the nested multiplication algorithm, and b_0, b_1, \dots, b_n is the sequence generated by that algorithm. Set $d_0 = b_0$ and generate the sequence d_1, d_2, \dots, d_{n-1} by the means of the algorithm

$$15. \quad d_i = cd_{i-1} + b_i, \quad \text{for } 1 \leq i \leq n-1;$$

then

$$16. \quad P'_n(c) = d_{n-1}.$$

Example: Find $P_4(1.4)$ and $P'_4(1.4)$ when

$$P_4(x) = 2.1x^4 - 3.7x^3 + 5.4x^2 - 1.1x - 7.2.$$

Use the result to perform three iterations of Newton's method to find the root approximated by $x = 1.4$.

Setting $c = 1.4$, $a_0 = 2.1$, $a_1 = -3.7$, $a_2 = 5.4$, $a_3 = -1.1$, and $a_4 = -7.2$ in the nested multiplication algorithm gives

$$\begin{aligned} b_0 &= 2.1, & b_1 &= -0.76000, & b_2 &= 4.33600, \\ b_3 &= 4.97040, & b_4 &= -0.24144, \end{aligned}$$

so

$$P_4(1.4) = b_4 = -0.24144.$$

Using these results in the algorithm for $P'_4(1.4)$ with $d_0 = b_0 = 2.1$ gives

$$d_1 = 2.18000, \quad d_2 = 7.38800, \quad d_3 = 15.31360,$$

so

$$P'_4(1.4) = d_3 = 15.31360.$$

Because $P_4(1.3) = -1.63508$ and $P_4(1.5) = 1.44375$, a root of $P_4(x)$ must lie in the interval $1.3 < x < 1.5$, so we take as our initial approximation $x_0 = 1.4$. A first application of the Newton algorithm gives

$$\begin{aligned} x_1 &= x_0 - \frac{P_4(1.4)}{P'_4(1.4)} \\ &= 1.4 - \frac{(-0.24144)}{15.31360} = 1.41576. \end{aligned}$$

Repetition of the process gives

$$\begin{aligned} x_2 &= 1.41576 - \frac{P_4(1.41576)}{P'_4(1.41576)} \\ &= 1.41576 - \frac{0.00355}{15.7784} = 1.41553 \end{aligned}$$

and

$$\begin{aligned} x_3 &= 1.41553 - \frac{P_4(1.41553)}{P'_4(1.41553)} \\ &= 1.41553 - \frac{(-0.00008)}{15.7715} = 1.41553. \end{aligned}$$

Thus, Newton's method has converged to five decimal places after only three iterations, showing that the required root is $x = 1.41553$.

2.1.1.6 Connection between Trigonometric and Hyperbolic Functions

1. $\sin x = \frac{(e^{ix} - e^{-ix})}{2i}$
2. $\cos x = \frac{(e^{ix} + e^{-ix})}{2}$
3. $\tan x = \frac{\sin x}{\cos x}$
4. $\sin(ix) = i \sinh x$
5. $\cos(ix) = \cosh x$
6. $\tan(ix) = i \tanh x$
7. $\sinh x = \frac{(e^x - e^{-x})}{2}$
8. $\cosh x = \frac{(e^x + e^{-x})}{2}$
9. $\tanh x = \frac{\sinh x}{\cosh x}$
10. $\sinh(ix) = i \sin x$
11. $\cosh(ix) = \cos x$
12. $\tanh(ix) = i \tan x$

The corresponding results for $\sec x$, $\csc x$, $\cot x$ and $\operatorname{sech} x$, $\operatorname{csch} x$, $\operatorname{coth} x$ follow from the above results and the definitions:

13. $\sec x = \frac{1}{\cos x}$
14. $\csc x = \frac{1}{\sin x}$
15. $\cot x = \frac{\cos x}{\sin x}$
16. $\operatorname{sech} x = \frac{1}{\cosh x}$
17. $\operatorname{csch} x = \frac{1}{\sinh x}$
18. $\operatorname{coth} x = \frac{\sinh x}{\cosh x}$

2.2 LOGARITHMS AND EXPONENTIALS

2.2.1 Basic Functional Relationships

2.2.1.1 The Logarithmic Function

Let $a > 0$, with $a \neq 1$. Then, if y is the **logarithm** of x to the **base** a ,

1. $y = \log_a x$ if and only if $a^y = x$
2. $\log_a 1 = 0$
3. $\log_a a = 1$

For all positive numbers x , y and all real numbers z :

4. $\log_a(xy) = \log_a x + \log_a y$
5. $\log_a(x/y) = \log_a x - \log_a y$

6. $\log_a(x^z) = z \log_a x$
7. $a^{\log_a x} = x$
8. $b^x = a^{x \log_a b}$
9. $y = \ln x$ if and only if $e^y = x$ [$e \approx 2.71828$]
(natural logarithm, or logarithm to the base e , or Napierian logarithm)
10. $\ln 1 = 0$
11. $\ln e = 1$
12. $\ln(xy) = \ln x + \ln y$
13. $\ln(x/y) = \ln x - \ln y$
14. $\ln(x^z) = z \ln x$
15. $e^{\ln x} = x$
16. $a^x = e^{x \ln a}$
17. $\log_a x = \log_b x / \log_b a$ (change from base a to base b)
18. $\log_{10} x = \ln x / \log_{10} e$ or $\ln x = 2.30258509 \log_{10} x$

Graphs of e^x and $\ln x$ are shown in Figure 2.5. The fact that each function is the inverse of the other can be seen by observing that each graph is the reflection of the other in the line $y = x$.

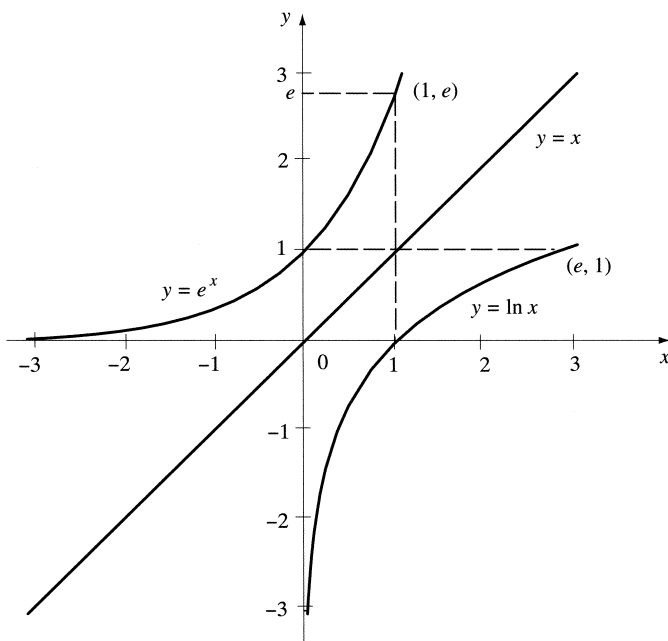

Figure 2.5.

2.2.2 The Number e

2.2.2.1 Definitions

1. $e = \lim_{n \rightarrow \infty} \left(1 + \frac{1}{n}\right)^n$
2. $e = \sum_{k=0}^{\infty} \frac{1}{k!} = 1 + \frac{1}{1!} + \frac{1}{2!} + \frac{1}{3!} + \dots$

To fifteen decimal places $e = 2.718281828459045$. A direct consequence of 2.2.2.1.1 and 2.2.2.1.2 is that for real a :

3. $e^a = \lim_{n \rightarrow \infty} \left(1 + \frac{a}{n}\right)^n$
4. $e^a = \sum_{k=0}^{\infty} \frac{a^k}{k!} = 1 + a + \frac{a^2}{2!} + \frac{a^3}{3!} + \dots$

2.3 THE EXPONENTIAL FUNCTION

2.3.1 Series Representations

2.3.1.1

1. $e^x = \sum_{k=0}^{\infty} \frac{x^k}{k!} = 1 + \frac{x}{1!} + \frac{x^2}{2!} + \frac{x^3}{3!} + \dots$
2. $e^{-x} = \sum_{k=0}^{\infty} (-1)^k \frac{x^k}{k!} = 1 - \frac{x}{1!} + \frac{x^2}{2!} - \frac{x^3}{3!} + \dots$
3. $e^{-x^2} = \sum_{k=0}^{\infty} (-1)^k \frac{x^{2k}}{k!} = 1 - \frac{x^2}{1!} + \frac{x^4}{2!} - \frac{x^6}{3!} + \dots$
4. $\frac{x}{e^x - 1} = 1 - \frac{x}{2} + \sum_{k=1}^{\infty} B_{2k} \frac{x^{2k}}{(2k)!} \quad [x < 2\pi]$ (see 1.3.1.1.1)

2.3.1.2

1. $e^{\sin x} = 1 + x + \frac{x^2}{2} - \frac{x^4}{8} - \frac{x^5}{15} - \frac{x^6}{240} + \frac{x^7}{90} + \dots$
2. $e^{\cos x} = e \left(1 - \frac{x^2}{2} + \frac{x^4}{6} - \frac{31x^6}{720} + \frac{379x^8}{40320} - \dots\right)$
3. $e^{\tan x} = 1 + x + \frac{x^2}{2} + \frac{x^3}{2} + \frac{3x^4}{8} + \frac{37x^5}{120} + \frac{59x^6}{240} + \dots$
4. $e^{\sec x} = e \left(1 + \frac{x^2}{2} + \frac{x^4}{3} + \frac{151x^6}{720} + \frac{5123x^8}{40320} \dots\right)$
5. $e^{x \sec x} = 1 + x + \frac{x^2}{2} + \frac{2x^3}{3} + \frac{13x^4}{24} + \frac{7x^5}{15} + \dots$

2.3.1.3

1. $e^{\arcsin x} = 1 + x + \frac{x^2}{2} + \frac{x^3}{3} + \frac{5x^4}{24} + \frac{x^5}{6} + \dots$
2. $e^{\arccos x} = e^{\pi/2} \left(1 - x + \frac{x^2}{2} - \frac{x^3}{3} + \frac{5x^4}{24} - \frac{x^5}{6} \dots \right)$
3. $e^{\arctan x} = 1 + x + \frac{x^2}{2!} - \frac{x^3}{6} - \frac{7x^4}{24} + \frac{x^5}{24} + \dots$
4. $e^{\sinh x} = 1 + x + \frac{x^2}{2} + \frac{x^3}{3} + \frac{5x^4}{24} + \frac{x^5}{10} + \frac{37x^6}{720} + \dots$
5. $e^{\cosh x} = e \left(1 + \frac{x^2}{2} + \frac{x^4}{6} + \frac{31x^6}{720} + \frac{379x^8}{40320} + \dots \right)$
6. $e^{\tanh x} = 1 + x + \frac{x^2}{2} - \frac{x^3}{6} - \frac{7x^4}{24} - \frac{x^5}{40} - \dots$
7. $e^{\operatorname{arcsinh} x} = x + \sqrt{x^2 + 1} = 1 + x + \frac{x^2}{2} - \frac{x^4}{8} + \frac{x^6}{16} - \frac{5x^8}{128} + \dots$
8. $e^{\operatorname{arctanh} x} = \left(\frac{1+x}{1-x} \right)^{1/2} = 1 + x + \frac{x^2}{2} + \frac{x^3}{2} + \frac{3x^4}{8} + \frac{3x^5}{8} + \dots$

2.4 TRIGONOMETRIC IDENTITIES

2.4.1 Trigonometric Functions

2.4.1.1 Basic Definitions

1. $\sin x = \frac{1}{2i} (e^{ix} - e^{-ix})$
2. $\cos x = \frac{1}{2} (e^{ix} + e^{-ix})$
3. $\tan x = \frac{\sin x}{\cos x}$
4. $\csc x = \frac{1}{\sin x}$
5. $\sec x = \frac{1}{\cos x}$
6. $\cot x = \frac{1}{\tan x}$ (also $\operatorname{ctn} x$)

Graphs of these functions are shown in Figure 2.6.

2.4.1.2 Even, Odd, and Periodic Functions

A function $f(x)$ is said to be an **even** function if it is such that $f(-x) = f(x)$ and to be an **odd** function if it is such that $f(-x) = -f(x)$. In general, an arbitrary function $g(x)$ defined for all x is neither even nor odd, although it can always be represented as the sum of an even function $h(x)$ and an odd function $k(x)$ by writing

$$g(x) = h(x) + k(x),$$

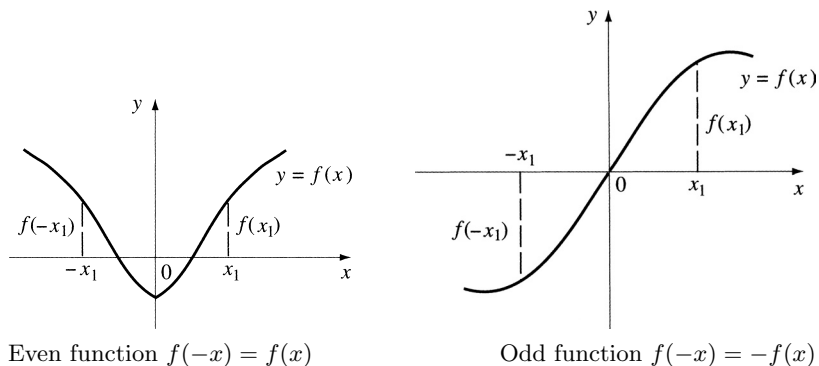

where

$$h(x) = \frac{1}{2}(g(x) + g(-x)), \quad k(x) = \frac{1}{2}(g(x) - g(-x)).$$

The product of two *even* or two *odd* functions is an *even* function, whereas the product of an *even* and an *odd* function is an *odd* function.

A function $f(x)$ is said to be **periodic** with **period** X if

$$f(x + X) = f(x),$$

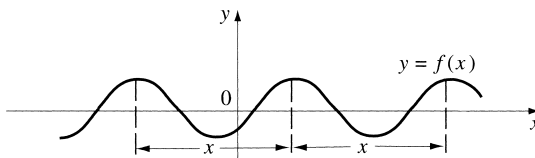

and X is the *smallest* number for which this is true.

2.4.1.3 Basic Relationships

1. $\sin(-x) = -\sin x$ (odd function)
2. $\cos(-x) = \cos x$ (even function)
3. $\tan(-x) = -\tan x$ (odd function)
4. $\csc(-x) = -\csc x$ (odd function)
5. $\sec(-x) = \sec x$ (even function)
6. $\cot(-x) = -\cot x$ (odd function)

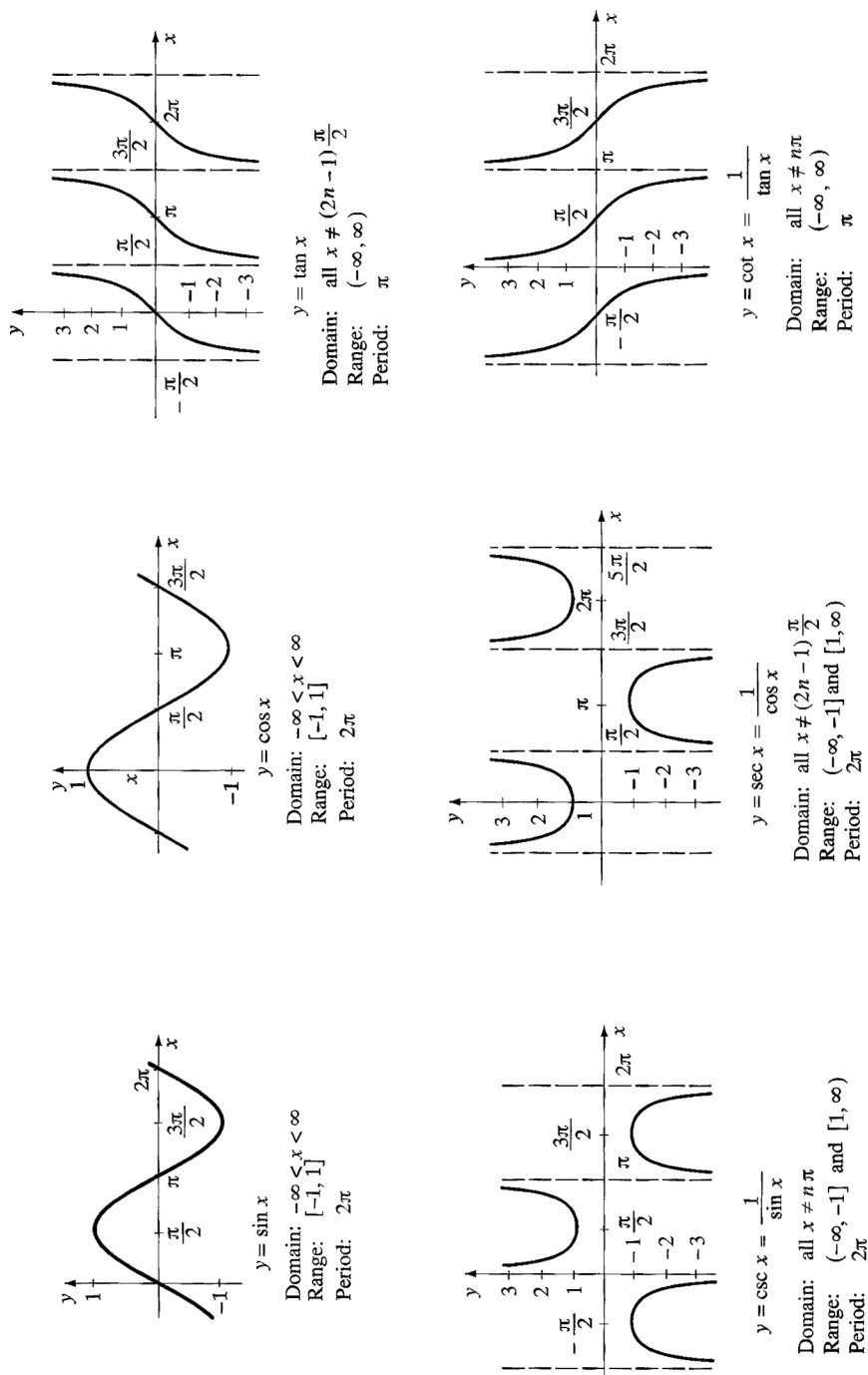

Figure 2.6. Graphs of trigonometric functions.

7. $\sin(x + 2\pi) = \sin x$ (periodic with period 2π)
8. $\cos(x + 2\pi) = \cos x$ (periodic with period 2π)
9. $\tan(x + \pi) = \tan x$ (periodic with period π)
10. $\sin(x + \pi) = -\sin x$
11. $\cos(x + \pi) = -\cos x$
12. $\cot\left(\frac{\pi}{2} - x\right) = \tan x$
13. $\csc\left(\frac{\pi}{2} - x\right) = \sec x$
14. $\sec\left(\frac{\pi}{2} - x\right) = \csc x$
15. $\sin^2 x + \cos^2 x = 1$
16. $\sec^2 x = 1 + \tan^2 x$
17. $\csc^2 x = 1 + \cot^2 x$
18. $\sin x = \pm\sqrt{(1 - \cos^2 x)}$
19. $\cos x = \pm\sqrt{(1 - \sin^2 x)}$
20. $\tan x = \pm\sqrt{(\sec^2 x - 1)}$

The choice of sign in entries 2.4.1.3.18 to 20 is determined by the quadrant in which the argument x is located. For x in the first quadrant the sine, cosine, and tangent functions are all positive, whereas for x in the second, third, and fourth quadrants only the sine, tangent, and cosine functions, respectively, are positive.

2.4.1.4 Sines and Cosines of Sums and Differences

1. $\sin(x + y) = \sin x \cos y + \cos x \sin y$
2. $\sin(x - y) = \sin x \cos y - \cos x \sin y$
3. $\cos(x + y) = \cos x \cos y - \sin x \sin y$
4. $\cos(x - y) = \cos x \cos y + \sin x \sin y$
5. $\sin x \cos y = \frac{1}{2}\{\sin(x + y) + \sin(x - y)\}$
6. $\cos x \cos y = \frac{1}{2}\{\cos(x + y) + \cos(x - y)\}$
7. $\sin x \sin y = \frac{1}{2}\{\cos(x - y) - \cos(x + y)\}$
8. $\sin^2 x - \sin^2 y = \sin(x + y) \sin(x - y)$
9. $\cos^2 x - \cos^2 y = \sin(x + y) \sin(y - x)$
10. $\cos^2 x - \sin^2 y = \cos(x + y) \cos(x - y)$

11. $\sin x + \sin y = 2 \sin \frac{1}{2}(x + y) \cos \frac{1}{2}(x - y)$
12. $\sin x - \sin y = 2 \sin \frac{1}{2}(x - y) \cos \frac{1}{2}(x + y)$
13. $\cos x + \cos y = 2 \cos \frac{1}{2}(x + y) \cos \frac{1}{2}(x - y)$
14. $\cos x - \cos y = 2 \sin \frac{1}{2}(x + y) \sin \frac{1}{2}(y - x)$
15. $\sin(x + iy) = \sin x \cosh y + i \cos x \sinh y$
16. $\sin(x - iy) = \sin x \cosh y - i \cos x \sinh y$
17. $\cos(x + iy) = \cos x \cosh y - i \sin x \sinh y$
18. $\cos(x - iy) = \cos x \cosh y + i \sin x \sinh y$

2.4.1.5 Tangents and Cotangents of Sums and Differences

1. $\tan(x + y) = \frac{\tan x + \tan y}{1 - \tan x \tan y}$
2. $\tan(x - y) = \frac{\tan x - \tan y}{1 + \tan x \tan y}$
3. $\cot(x + y) = \frac{\cot x \cot y - 1}{\cot x + \cot y}$
4. $\cot(x - y) = \frac{\cot x \cot y + 1}{\cot y - \cot x}$
5. $\tan x + \tan y = \frac{\sin(x + y)}{\cos x \cos y}$
6. $\tan x - \tan y = \frac{\sin(x - y)}{\cos x \cos y}$
7. $\tan x = \cot x - 2 \cot 2x$ (from 2.4.1.5.3 with $y = x$)
8. $\tan(x + iy) = \frac{\sin 2x + i \sinh 2y}{\cos 2x + \cosh 2y}$
9. $\tan(x - iy) = \frac{\sin 2x - i \sinh 2y}{\cos 2x + \cosh 2y}$
10. $\cot(x + iy) = \frac{1 + i \coth y \cot x}{\cot x - i \coth y}$
11. $\cot(x + iy) = \frac{1 - i \coth y \cot x}{\cot x + i \coth y}$

2.4.1.6 Sines, Cosines, and Tangents of Multiple Angles

1. $\sin 2x = 2 \sin x \cos x$
2. $\sin 3x = 3 \sin x - 4 \sin^3 x$

3. $\sin 4x = \cos x (4 \sin x - 8 \sin^3 x)$
4. $\sin nx = n \cos^{n-1} x \sin x - \binom{n}{3} \cos^{n-3} x \sin^3 x + \binom{n}{5} \cos^{n-5} x \sin^5 x + \dots$
 $= \sin x \left[2^{n-1} \cos^{n-1} x - \binom{n-2}{1} 2^{n-3} x \cos^{n-3} x + \binom{n-3}{2} 2^{n-5} \cos^{n-5} x \right.$
 $\left. - \binom{n-4}{3} 2^{n-7} \cos^{n-7} x + \dots \right] \quad [n = 2, 3, \dots, \text{ and } \binom{m}{k} = 0, k > m]$
5. $\cos 2x = 2 \cos^2 x - 1$
6. $\cos 3x = 4 \cos^3 x - 3 \cos x$
7. $\cos 4x = 8 \cos^4 x - 8 \cos^2 x + 1$
8. $\cos nx = \cos^n x - \binom{n}{2} \cos^{n-2} x \sin^2 x + \binom{n}{4} \cos^{n-4} x \sin^4 x - \dots$
 $= 2^{n-1} \cos^n x - \frac{n}{1} 2^{n-3} \cos^{n-2} x + \frac{n}{2} \binom{n-3}{1} 2^{n-5} \cos^{n-4} x$
 $- \frac{n}{3} \binom{n-4}{2} 2^{n-7} \cos^{n-6} x + \dots \quad [n = 2, 3, \dots, \text{ and } \binom{m}{k} = 0, k > m]$
9. $\tan 2x = \frac{2 \tan x}{1 - \tan^2 x}$
10. $\tan 3x = \frac{3 \tan x - \tan^3 x}{1 - 3 \tan^2 x}$
11. $\tan 4x = \frac{4 \tan x - 4 \tan^3 x}{1 - 6 \tan^2 x + \tan^4 x}$
12. $\tan 5x = \frac{5 \tan x - 10 \tan^3 x + \tan^5 x}{1 - 10 \tan^2 x + 5 \tan^4 x}$
13. $\sum_{k=1}^n \sin kx = \frac{1}{2} \cot x - \frac{\cos[(n + \frac{1}{2})x]}{2 \sin(\frac{1}{2}x)}$
14. $\sum_{k=1}^n \cos kx = \frac{\sin[(n + \frac{1}{2})x]}{2 \sin(\frac{1}{2}x)} - \frac{1}{2}$
15. $\sum_{k=1}^n \sin kx = \frac{\sin[\frac{1}{2}(n+1)x] \sin(\frac{1}{2}nx)}{\sin[\frac{1}{2}x]}$
16. $\sum_{k=0}^{n-1} \sin(x + ky) = \sin x + \sin(x + y) + \sin(x + 2y) + \dots + \sin[x + (n-1)y]$
 $= \frac{\sin[x + \frac{1}{2}(n-1)y] \sin(\frac{1}{2}ny)}{\sin(\frac{1}{2}y)}$
17. $\sum_{k=0}^{n-1} \cos(x + ky) = \cos x + \cos(x + y) + \cos(x + 2y) + \dots + \cos[x + (n-1)y]$
 $= \frac{\cos[x + \frac{1}{2}(n-1)y] \sin(\frac{1}{2}ny)}{\sin(\frac{1}{2}y)}$

Results 13 and 14 are called the **Lagrange trigonometric identities**. Result 15 follows from result 13 after using **2.4.1.7**.

2.4.1.7 Powers of Sines, Cosines, and Tangents in Terms of Multiple Angles

1. $\sin^2 x = \frac{1}{2} (1 - \cos 2x)$
2. $\sin^3 x = \frac{1}{4} (3 \sin x - \sin 3x)$
3. $\sin^4 x = \frac{1}{8} (3 - 4 \cos 2x + \cos 4x)$
4. $\sin^{2n-1} x = \frac{1}{2^{2n-2}} \sum_{k=0}^{n-1} (-1)^{n+k-1} \binom{2n-1}{k} \sin(2n-2k-1)x \quad [n = 1, 2, \dots]$
5. $\sin^{2n} x = \frac{1}{2^{2n}} \left\{ \sum_{k=0}^{n-1} (-1)^{n-k} 2 \binom{2n}{k} \cos 2(n-k)x + \binom{2n}{n} \right\} \quad [n = 1, 2, \dots]$
6. $\cos^2 x = \frac{1}{2} (1 + \cos 2x)$
7. $\cos^3 x = \frac{1}{4} (3 \cos x + \cos 3x)$
8. $\cos^4 x = \frac{1}{8} (3 + 4 \cos 2x + \cos 4x)$
9. $\cos^{2n-1} x = \frac{1}{2^{2n-2}} \sum_{k=0}^{n-1} \binom{2n-1}{k} \cos(2n-2k-1)x \quad [n = 1, 2, \dots]$
10. $\cos^{2n} x = \frac{1}{2^{2n}} \left\{ \sum_{k=0}^{n-1} 2 \binom{2n}{k} \cos 2(n-k)x + \binom{2n}{n} \right\} \quad [n = 1, 2, \dots]$
11. $\tan^2 x = \frac{1 - \cos 2x}{1 + \cos 2x}$
12. $\tan^3 x = \frac{3 \sin x - \sin 3x}{3 \cos x + \cos 3x}$
13. $\tan^4 x = \frac{3 - 4 \cos 2x + \cos 4x}{3 + 4 \cos 2x + \cos 4x}$
14. For $\tan^n x$ use $\tan^n x = \sin^n x / \cos^n x$ with 2.4.1.7.4 and 2.4.1.7.9 or 2.4.1.7.5 and 2.4.1.7.10.

2.4.1.8 Half Angle Representations of Trigonometric Functions

1. $\sin \frac{x}{2} = \pm \left(\frac{1 - \cos x}{2} \right)^{1/2} \quad [+ \text{ sign if } 0 < x < 2\pi \text{ and } - \text{ sign if } 2\pi < x < 4\pi]$
2. $\cos \frac{x}{2} = \pm \left(\frac{1 + \cos x}{2} \right)^{1/2} \quad [+ \text{ sign if } -\pi < x < \pi \text{ and } - \text{ sign if } \pi < x < 3\pi]$

$$3. \quad \tan \frac{x}{2} = \frac{\sin x}{1 + \cos x} = \frac{1 - \cos x}{\sin x}$$

$$4. \quad \cot \frac{x}{2} = \frac{1 + \cos x}{\sin x} = \frac{\sin x}{1 - \cos x}$$

$$5. \quad \sin x = 2 \sin \frac{x}{2} \cos \frac{x}{2}$$

$$6. \quad \cos x = \cos^2 \frac{x}{2} - \sin^2 \frac{x}{2}$$

$$7. \quad \tan x = \frac{2 \tan \frac{x}{2}}{1 - \tan^2 \frac{x}{2}} = \frac{2 \cot \frac{x}{2}}{\csc^2 \frac{x}{2} - 2}$$

2.4.1.9 Sum of Multiples of $\sin x$ and $\cos x$

1. $A \sin x + B \cos x = R \sin(x + \theta)$, where $R = (A^2 + B^2)^{1/2}$ with $\theta = \arctan B/A$ when $A > 0$ and $\theta = \pi + \arctan B/A$ when $A < 0$.
2. $A \cos x + B \sin x = R \cos(x - \theta)$, where $R = (A^2 + B^2)^{1/2}$ with $\theta = \arctan B/A$ when $A > 0$ and $\theta = \pi + \arctan B/A$ when $A < 0$.

Here R is the amplitude of the resulting sinusoid and θ is the phase angle.

2.4.1.10 Quotients of $\sin(nx)$ and $\cos(nx)$ Divided by $\sin^n x$ and $\cos^n x$

1. $\frac{\cos 2x}{\cos^2 x} = 1 - \tan^2 x$
2. $\frac{\cos 3x}{\cos^3 x} = 1 - 3 \tan^2 x$
3. $\frac{\cos 4x}{\cos^4 x} = 1 - 6 \tan^2 x + \tan^4 x$
4. $\frac{\cos 5x}{\cos^5 x} = 1 - 10 \tan^2 x + 5 \tan^4 x$
5. $\frac{\cos 6x}{\cos^6 x} = 1 - 15 \tan^2 x + 15 \tan^4 x - \tan^6 x$
6. $\frac{\sin 2x}{\cos^2 x} = 2 \tan x$
7. $\frac{\sin 3x}{\cos^3 x} = 3 \tan x - \tan^3 x$
8. $\frac{\sin 4x}{\cos^4 x} = 4 \tan x - 4 \tan^3 x$
9. $\frac{\sin 5x}{\cos^5 x} = 5 \tan x - 10 \tan^3 x + \tan^5 x$
10. $\frac{\sin 6x}{\cos^6 x} = 6 \tan x - 20 \tan^3 x + 6 \tan^5 x$
11. $\frac{\cos 2x}{\sin^2 x} = \cot^2 x - 1$
12. $\frac{\cos 3x}{\sin^3 x} = \cot^3 x - 3 \cot x$
13. $\frac{\cos 4x}{\sin^4 x} = \cot^4 x - 6 \cot^2 x + 1$
14. $\frac{\cos 5x}{\sin^5 x} = \cot^5 x - 10 \cot^3 x + 5 \cot x$
15. $\frac{\cos 6x}{\sin^6 x} = \cot^6 x - 15 \cot^4 x + 15 \cot^2 x - 1$
16. $\frac{\sin 2x}{\sin^2 x} = 2 \cot x$

17. $\frac{\sin 3x}{\sin^3 x} = 3 \cot^2 x - 1$

18. $\frac{\sin 4x}{\sin^4 x} = 4 \cot^3 x - 4 \cot x$

19. $\frac{\sin 5x}{\sin^5 x} = 5 \cot^4 x - 10 \cot^2 x + 1$

20. $\frac{\sin 6x}{\sin^6 x} = 6 \cot^5 x - 20 \cot^3 x + 6 \cot x$

2.5 HYPERBOLIC IDENTITIES

2.5.1 Hyperbolic Functions

2.5.1.1 Basic Definitions

1. $\sinh x = \frac{1}{2} (e^x - e^{-x})$

2. $\cosh x = \frac{1}{2} (e^x + e^{-x})$

3. $\tanh x = \frac{\sinh x}{\cosh x}$

4. $\operatorname{csch} x = \frac{1}{\sinh x}$

5. $\operatorname{sech} x = \frac{1}{\cosh x}$

6. $\operatorname{coth} x = \frac{1}{\tanh x}$

Other notations are also in use for these *same* hyperbolic functions. Equivalent notations are $\sinh, \operatorname{sh}; \cosh, \operatorname{ch}; \tanh, \operatorname{th}; \operatorname{csch}, \operatorname{csh}; \operatorname{sech}, \operatorname{sch}; \operatorname{coth}, \operatorname{ctnh}, \operatorname{cth}$. Graphs of these functions are shown in Figure 2.7.

2.5.1.2 Basic Relationships

1. $\sinh(-x) = -\sinh x$ (odd function)

2. $\cosh(-x) = \cosh x$ (even function)

3. $\tanh(-x) = -\tanh x$ (odd function)

4. $\operatorname{csch}(-x) = -\operatorname{csch}(x)$ (odd function)

5. $\operatorname{sech}(-x) = \operatorname{sech} x$ (even function)

6. $\operatorname{coth}(-x) = -\operatorname{coth} x$ (odd function)

7. $\cosh^2 x - \sinh^2 x = 1$

8. $\operatorname{sech}^2 x = 1 - \tanh^2 x$

9. $\operatorname{csch}^2 x = \operatorname{coth}^2 x - 1$

10. $\sinh x = \begin{cases} \sqrt{(\cosh^2 x - 1)}, & [x > 0] \\ -\sqrt{(\cosh^2 x - 1)}, & [x < 0] \end{cases}$

11. $\cosh x = \sqrt{(1 + \sinh^2 x)}$

12. $\tanh x = \begin{cases} \sqrt{(1 - \operatorname{sech}^2 x)}, & [x > 0] \\ -\sqrt{(1 - \operatorname{sech}^2 x)}, & [x < 0] \end{cases}$

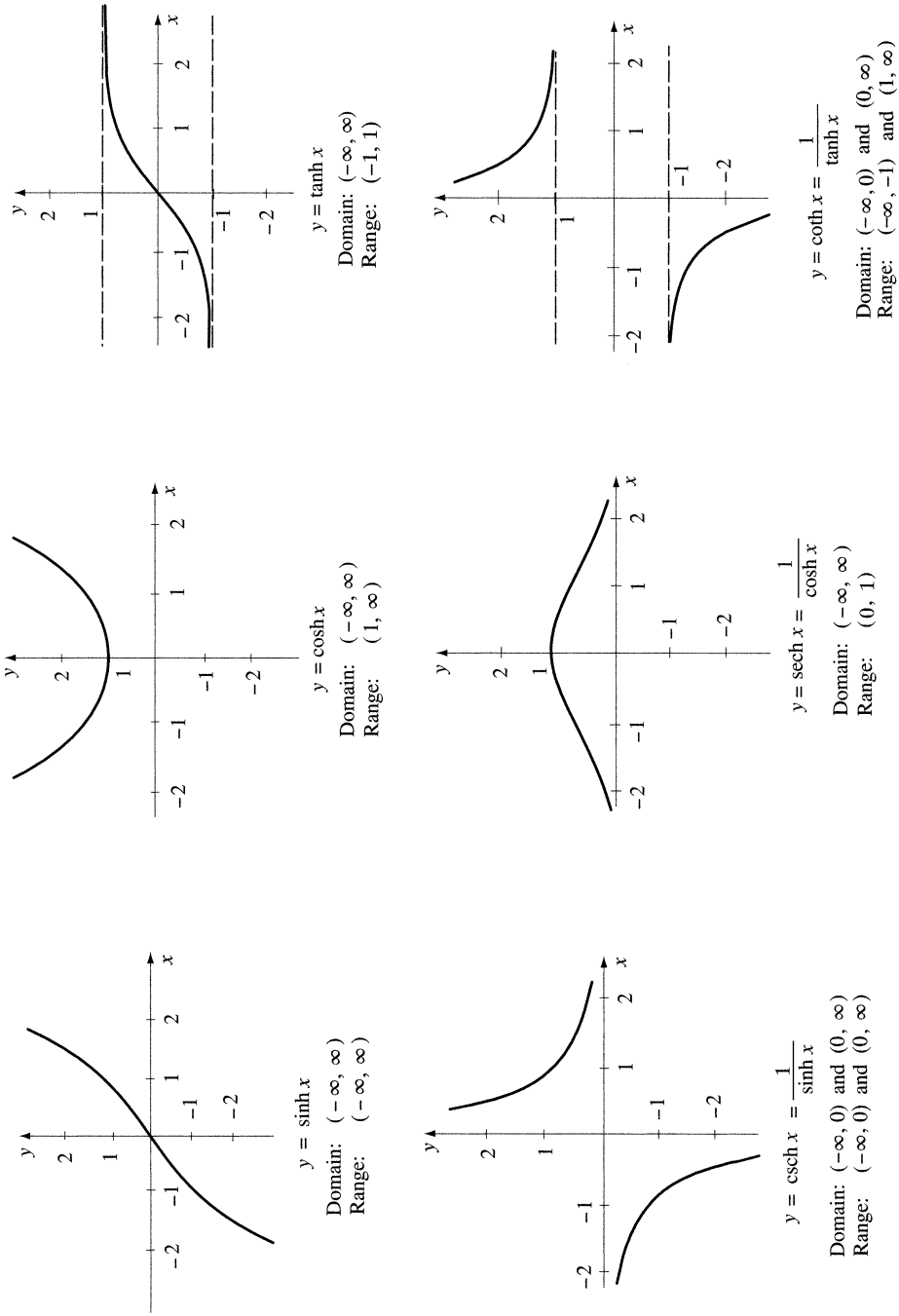

Figure 2.7. Graphs of hyperbolic functions.

2.5.1.3 Hyperbolic Sines and Cosines of Sums and Differences

1. $\sinh(x + y) = \sinh x \cosh y + \cosh x \sinh y$
2. $\sinh(x - y) = \sinh x \cosh y - \cosh x \sinh y$
3. $\cosh(x + y) = \cosh x \cosh y + \sinh x \sinh y$
4. $\cosh(x - y) = \cosh x \cosh y - \sinh x \sinh y$
5. $\sinh x \cosh y = \frac{1}{2}\{\sinh(x + y) + \sinh(x - y)\}$
6. $\cosh x \cosh y = \frac{1}{2}\{\cosh(x + y) + \cosh(x - y)\}$
7. $\sinh x \sinh y = \frac{1}{2}\{\cosh(x + y) - \cosh(x - y)\}$
8. $\sinh^2 x - \sinh^2 y = \sinh(x + y) \sinh(x - y)$
9. $\sinh^2 x + \cosh^2 y = \cosh(x + y) \cosh(x - y)$
10. $\sinh x + \sinh y = 2 \sinh \frac{1}{2}(x + y) \cosh \frac{1}{2}(x - y)$
11. $\sinh x - \sinh y = 2 \sinh \frac{1}{2}(x - y) \cosh \frac{1}{2}(x + y)$
12. $\cosh x + \cosh y = 2 \cosh \frac{1}{2}(x + y) \cosh \frac{1}{2}(x - y)$
13. $\cosh x - \cosh y = 2 \sinh \frac{1}{2}(x + y) \sinh \frac{1}{2}(x - y)$
14. $\cosh x - \sinh x = 1 / (\sinh x + \cosh x)$
15. $(\sinh x + \cosh x)^n = \sinh nx + \cosh nx$
16. $(\sinh x - \cosh x)^n = \sinh nx - \cosh nx$
17. $\sinh(x + iy) = \sinh x \cos y + i \cosh x \sin y$
18. $\sinh(x - iy) = \sinh x \cos y - i \cosh x \sin y$
19. $\cosh(x + iy) = \cosh x \cos y + i \sinh x \sin y$
20. $\cosh(x - iy) = \cosh x \cos y - i \sinh x \sin y$

2.5.1.4 Hyperbolic Tangents and Cotangents of Sums and Differences

1. $\tanh(x + y) = \frac{\tanh x + \tanh y}{1 + \tanh x \tanh y}$
2. $\tanh(x - y) = \frac{\tanh x - \tanh y}{1 - \tanh x \tanh y}$
3. $\coth(x + y) = \frac{\coth x \coth y + 1}{\coth y + \coth x}$

4. $\coth(x - y) = \frac{\coth x \coth y - 1}{\coth y - \coth x}$
5. $\tanh x + \tanh y = \frac{\sinh(x + y)}{\cosh x \cosh y}$
6. $\tanh x - \tanh y = \frac{\sinh(x - y)}{\cosh x \cosh y}$
7. $\tanh x = 2 \coth 2x - \coth x$ (from 2.5.1.4.3 with $y = x$)
8. $\tanh(x + iy) = \frac{\sinh 2x + i \sin 2y}{\cosh 2x + \cos 2y}$
9. $\tanh(x - iy) = \frac{\sinh 2x - \sin 2y}{\cosh 2x + \cos 2y}$
10. $\coth(x + iy) = \frac{\cosh x \cos y + i \sinh x \sin y}{\sinh x \cos y + i \cosh x \sin y}$
11. $\coth(x + iy) = \frac{\cosh x \cos y - i \sinh x \sin y}{\sinh x \cos y - i \cosh x \sin y}$

2.5.1.5 Hyperbolic Sines, Cosines, and Tangents of Multiple Arguments

1. $\sinh 2x = 2 \sinh x \cosh x$
2. $\sinh 3x = 3 \sinh x + 4 \sinh^3 x$
3. $\sinh 4x = \cosh x (4 \sinh x + 8 \sinh^3 x)$
4. $\sinh nx = \sum_{k=1}^{[(n+1)/2]} \binom{n}{2k-1} \sinh^{2k-1} x \cosh^{n-2k+1} x$
 $[n = 2, 3, \dots, \text{with } [(n+1)/2] \text{ denoting the integral part of } (n+1)/2]$
5. $\cosh 2x = 2 \cosh^2 x - 1$
6. $\cosh 3x = 4 \cosh^3 x - 3 \cosh x$
7. $\cosh 4x = 8 \cosh^4 x - 8 \cosh^2 x + 1$
8. $\cosh nx = 2^{n-1} \cosh^n x + n \sum_{k=1}^{[n/2]} (-1)^k \frac{1}{k} \binom{n-k-1}{k-1} 2^{n-2k-1} \cosh^{n-2k} x$
 $[n = 2, 3, \dots \text{ with } [n/2] \text{ denoting the integral part of } n/2]$

$$9. \quad \tanh 2x = \frac{2 \tanh x}{1 + \tanh^2 x}$$

$$10. \quad \tanh 3x = \frac{\tanh^3 x + 3 \tanh x}{1 + 3 \tanh^2 x}$$

$$11. \quad \tanh 4x = \frac{4 \tanh^3 x + 4 \tanh x}{1 + 6 \tanh^2 x + \tanh^4 x}$$

2.5.1.6 Powers of Hyperbolic Sines, Cosines, and Tangents in Terms of Multiple Arguments

1. $\sinh^2 x = \frac{1}{2} (\cosh 2x - 1)$
2. $\sinh^3 x = \frac{1}{4} (\sinh 3x - 3 \sinh x)$
3. $\sinh^4 x = \frac{1}{8} (3 - 4 \cosh 2x + \cosh 4x)$
4. $\sinh^{2n-1} x = \frac{(-1)^{n-1}}{2^{2n-2}} \sum_{k=0}^{n-1} (-1)^{n+k-1} \binom{2n-1}{k} \sinh (2n - 2k - 1) x \quad [n = 1, 2, \dots]$
5. $\sinh^{2n} x = \frac{(-1)^n}{2^{2n}} \left\{ \sum_{k=0}^{n-1} (-1)^{n-k} 2 \binom{2n}{k} \cosh 2(n - k) x + \binom{2n}{n} \right\} \quad [n = 1, 2, \dots]$
6. $\cosh^2 x = \frac{1}{2} (1 + \cosh 2x)$
7. $\cosh^3 x = \frac{1}{4} (3 \cosh x + \cosh 3x)$
8. $\cosh^4 x = \frac{1}{8} (3 + 4 \cosh 2x + \cosh 4x)$
9. $\cosh^{2n-1} x = \frac{1}{2^{2n-2}} \sum_{k=0}^{n-1} \binom{2n-1}{k} \cosh (2n - 2k - 1) x \quad [n = 1, 2, \dots]$
10. $\cosh^{2n} x = \frac{1}{2^{2n}} \left\{ \sum_{k=0}^{n-1} 2 \binom{2n}{k} \cosh 2(n - k) x + \binom{2n}{n} \right\} \quad [n = 1, 2, \dots]$
11. $\tanh^2 x = \frac{\cosh 2x - 1}{1 + \cosh 2x}$
12. $\tanh^3 x = \frac{\sinh 3x - 3 \sinh x}{3 \cosh x + \cosh 3x}$
13. $\tanh^4 x = \frac{3 - 4 \cosh 2x + \cosh 4x}{3 + 4 \cosh 2x + \cosh 4x}$
14. For $\tanh^n x$ use $\tanh^n x = \sinh^n x / \cosh^n x$ with 2.5.1.6.4 and 2.5.1.6.9, or 2.5.1.6.5 and 2.5.1.6.10.

2.5.1.7 Half-Argument Representations of Hyperbolic Functions

1. $\sinh \frac{x}{2} = \pm \left(\frac{\cosh x - 1}{2} \right)^{1/2}$ [+ sign if $x > 0$ and - sign if $x < 0$]
2. $\cosh \frac{x}{2} = \left(\frac{1 + \cosh x}{2} \right)^{1/2}$
3. $\tanh \frac{x}{2} = \frac{\sinh x}{1 + \cosh x} = \frac{\cosh x - 1}{\sinh x}$
4. $\coth \frac{x}{2} = \frac{\sinh x}{\cosh x - 1} = \frac{\cosh x + 1}{\sinh x}$
5. $\sinh x = 2 \sinh \frac{x}{2} \cosh \frac{x}{2}$
6. $\cosh x = \cosh^2 \frac{x}{2} + \sinh^2 \frac{x}{2}$
7. $\tanh x = \frac{2 \tanh \frac{x}{2}}{1 + \tanh^2 \frac{x}{2}} = \frac{2 \coth \frac{x}{2}}{\operatorname{csch}^2 \frac{x}{2} + 2}$

2.6 THE LOGARITHM

2.6.1 Series Representations

2.6.1.1

1. $\ln(1+x) = x - \frac{1}{2}x^2 + \frac{1}{3}x^3 - \frac{1}{4}x^4 + \dots = \sum_{k=1}^{\infty} (-1)^{k+1} \frac{x^k}{k}$ [$-1 < x \leq 1$]
2. $\ln(1-x) = -\left[x + \frac{x^2}{2} + \frac{x^3}{3} + \frac{x^4}{4} + \dots \right] = -\sum_{k=1}^{\infty} \frac{x^k}{k}$ [$-1 \leq x < 1$]
3. $\ln 2 = 1 - \frac{1}{2} + \frac{1}{3} - \frac{1}{4} + \frac{1}{5} - \dots$

2.6.1.2

1. $\ln x = (x-1) - \frac{1}{2}(x-1)^2 + \frac{1}{3}(x-1)^3 - \dots = \sum_{k=1}^{\infty} (-1)^{k+1} \frac{(x-1)^k}{k}$ [$0 < x \leq 2$]
2. $\ln x = 2 \left[\frac{x-1}{x+1} + \frac{1}{3} \left(\frac{x-1}{x+1} \right)^3 + \frac{1}{5} \left(\frac{x-1}{x+1} \right)^5 + \dots \right]$
 $= 2 \sum_{k=1}^{\infty} \frac{1}{2k-1} \left(\frac{x-1}{x+1} \right)^{2k-1}$ [$0 < x$]

$$3. \ln x = \frac{x-1}{x} + \frac{1}{2} \left(\frac{x-1}{x} \right)^2 + \frac{1}{3} \left(\frac{x-1}{x} \right)^3 + \dots = \sum_{k=1}^{\infty} \frac{1}{k} \left(\frac{x-1}{x} \right)^k \quad \left[x \geq \frac{1}{2} \right]$$

2.6.1.3

$$1. \ln \left(\frac{1+x}{1-x} \right) = 2 \sum_{k=1}^{\infty} \frac{1}{2k-1} x^{2k-1} = 2 \operatorname{arctanh} x \quad [x^2 < 1]$$

$$2. \ln \left(\frac{x+1}{x-1} \right) = 2 \sum_{k=1}^{\infty} \frac{1}{(2k-1)x^{2k-1}} = 2 \operatorname{arccoth} x \quad [x^2 > 1]$$

$$3. \ln \left(\frac{x}{x-1} \right) = \sum_{k=1}^{\infty} \frac{1}{kx^k} \quad [x \leq -1 \text{ or } x > 1]$$

$$4. \ln \left(\frac{1}{1-x} \right) = \sum_{k=1}^{\infty} \frac{x^k}{k} \quad [-1 \leq x < 1]$$

$$5. \left(\frac{1-x}{x} \right) \ln \left(\frac{1}{1-x} \right) = 1 - \sum_{k=1}^{\infty} \frac{x^k}{k(k+1)} \quad [-1 \leq x < 1]$$

$$6. \left(\frac{1}{1-x} \right) \ln \left(\frac{1}{1-x} \right) = \sum_{k=1}^{\infty} \left\{ x^k \sum_{n=1}^k \frac{1}{n} \right\} \quad [x^2 < 1]$$

2.6.1.4

$$1. \ln(1 + \sqrt{1+x^2}) = \ln 2 + \frac{1 \cdot 1}{2 \cdot 2} x^2 + \frac{1 \cdot 1 \cdot 3}{2 \cdot 4 \cdot 4} x^4 + \frac{1 \cdot 1 \cdot 3 \cdot 5}{2 \cdot 4 \cdot 6 \cdot 6} x^6 - \dots$$

$$= \ln 2 - \sum_{k=1}^{\infty} (-1)^k \frac{(2k-1)!}{2^{2k} (k!)^2} x^{2k} \quad [x^2 \leq 1]$$

$$2. \ln(1 + \sqrt{1+x^2}) = \ln x + \frac{1}{x} - \frac{1}{2 \cdot 3x^3} + \frac{1 \cdot 3}{2 \cdot 4 \cdot 5x^5} - \dots$$

$$= \ln x + \frac{1}{x} + \sum_{k=1}^{\infty} (-1)^k \frac{(2k-1)!}{2^{2k-1} \cdot k! (k-1)! (2k+1)} x^{2k+1} \quad [x^2 \geq 1]$$

2.6.1.5

$$1. \ln \sin x = \ln x - \frac{x^2}{6} - \frac{x^4}{180} - \frac{x^6}{2835} - \dots$$

$$= \ln x + \sum_{k=1}^{\infty} \frac{(-1)^k 2^{2k-1} B_{2k} x^{2k}}{k (2k)!} \quad [0 < x < \pi]$$

$$2. \ln \cos x = -\frac{x^2}{2} - \frac{x^4}{12} - \frac{x^6}{45} - \frac{17x^8}{2520} - \dots$$

$$= -\sum_{k=1}^{\infty} \frac{2^{2k-1} (2^{2k} - 1) |B_{2k}|}{k (2k)!} x^{2k} = -\frac{1}{2} \sum_{k=1}^{\infty} \frac{\sin^{2k} x}{k} \quad \left[x^2 < \frac{\pi^2}{4} \right]$$

$$\begin{aligned} 3. \quad \ln \tan x &= \ln x + \frac{x^2}{3} + \frac{7}{90}x^4 + \frac{62}{2835}x^6 + \frac{127}{18,900}x^8 + \cdots \\ &= \ln x + \sum_{k=1}^{\infty} (-1)^{k+1} \frac{(2^{2k-1} - 1) 2^{2k} B_{2k} x^{2k}}{k (2k)!} \quad \left[0 < x < \frac{\pi}{2} \right] \end{aligned}$$

2.7 INVERSE TRIGONOMETRIC AND HYPERBOLIC FUNCTIONS

2.7.1 Domains of Definition and Principal Values

Other notations are also in use for the *same* inverse trigonometric and hyperbolic functions. Equivalent notations are \arcsin , \sin^{-1} ; \arccos , \cos^{-1} ; \arctan , \tan^{-1} , arctg ; arccot , \cot^{-1} ; arcsinh , \sinh^{-1} , arsh ; arccosh , \cosh^{-1} , arch ; arctanh , \tanh^{-1} , arth ; arcoth , \coth^{-1} , arth . Graphs of these functions are shown in Figures 2.8 and 2.9.

<i>Function</i>	<i>Inverse function</i>	<i>Principal value</i>	<i>Domain</i>
$x = \sin y$	$y = \arcsin x$	$-\frac{\pi}{2} \leq \arcsin x \leq \frac{\pi}{2}$	$-1 \leq x \leq 1$
$x = \cos y$	$y = \arccos x$	$0 \leq \arccos x \leq \pi$	$-1 \leq x \leq 1$
$x = \tan y$	$y = \arctan x$	$-\frac{\pi}{2} < \arctan x < \frac{\pi}{2}$	$-\infty < x < \infty$
$x = \cot y$	$y = \text{arccot } x$	$0 < \text{arccot } x < \pi$	$-\infty < x < \infty$
$x = \sinh y$	$y = \text{arcsinh } x$	$-\infty < \text{arcsinh } x < \infty$	$-\infty < x < \infty$
$x = \cosh y$	$y = \text{arccosh } x$	$0 \leq \text{arccosh } x < \infty$	$1 \leq x < \infty$
$x = \tanh y$	$y = \text{arctanh } x$	$-\infty < \text{arctanh } x < \infty$	$-1 < x < 1$
$x = \coth y$	$y = \text{arcoth } x$	$\begin{cases} -\infty < \text{arcoth } x \leq 0 \\ 0 \leq \text{arcoth } x < \infty \end{cases}$	$\begin{cases} -\infty < x < -1 \\ 1 < x < \infty \end{cases}$

2.7.2 Functional Relations

2.7.2.1 Relationship Between Trigonometric and Inverse Trigonometric Functions

$$\begin{aligned} 1. \quad \arcsin(\sin x) &= x - 2n\pi \quad \left[2n\pi - \frac{1}{2}\pi \leq x \leq 2n\pi + \frac{1}{2}\pi \right] \\ &= -x + (2n+1)\pi \quad \left[(2n+1)\pi - \frac{1}{2}\pi \leq x \leq (2n+1)\pi + \frac{1}{2}\pi \right] \end{aligned}$$

$$\begin{aligned} 2. \quad \arccos(\cos x) &= x - 2n\pi \quad [2n\pi \leq x \leq (2n+1)\pi] \\ &= -x + 2(n+1)\pi \quad [(2n+1)\pi \leq x \leq 2(n+1)\pi] \end{aligned}$$

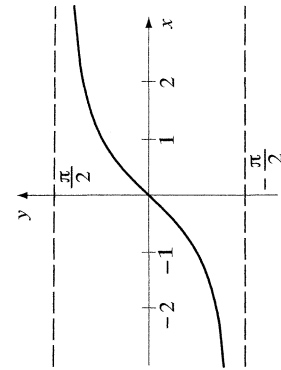

$y = \arctan x$
 Domain: $(-\infty, \infty)$
 Range: $(-\pi/2, \pi/2)$

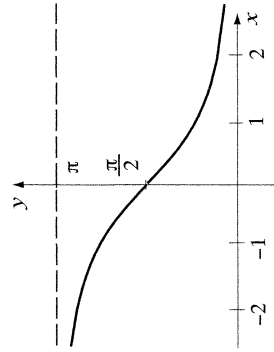

$y = \operatorname{arccot} x$
 Domain: $(-\infty, \infty)$
 Range: $(0, \pi)$

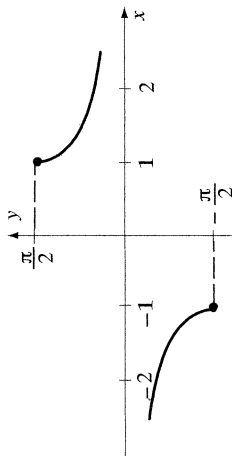

$y = \operatorname{arcsec} x$
 Domain: $(-\infty, -1]$ and $[1, \infty)$
 Range: $[2\pi/2, 0)$ and $(0, \pi/2]$

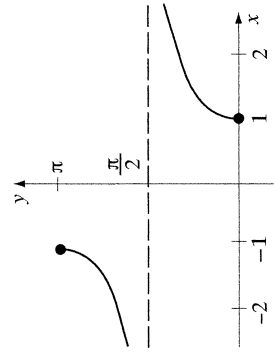

$y = \operatorname{arccsc} x$
 Domain: $(-\infty, -1]$ and $[1, \infty)$
 Range: $[0, \pi/2)$ and $(\pi/2, \pi]$

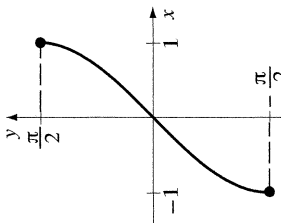

$y = \arcsin x$
 Domain: $[-1, 1]$
 Range: $[-\pi/2, \pi/2]$

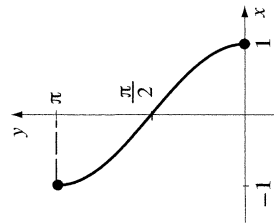

$y = \arccos x$
 Domain: $[-1, 1]$
 Range: $(0, \pi)$

Figure 2.8. Graphs of inverse trigonometric functions.

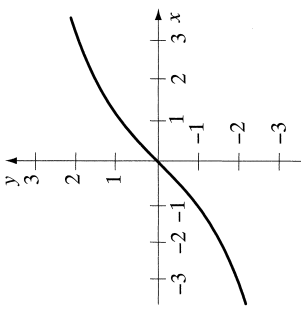

$y = \operatorname{arsinh} x$
 Domain: $(-\infty, \infty)$
 Range: $(-\infty, \infty)$

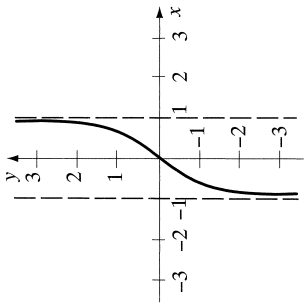

$y = \operatorname{artanh} x$
 Domain: $(-1, 1)$
 Range: $(-\infty, \infty)$

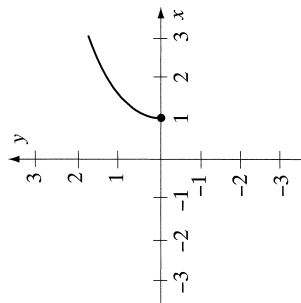

$y = \operatorname{arcosh} x$
 Domain: $[1, \infty)$
 Range: $[0, \infty)$

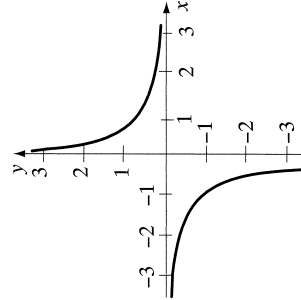

$y = \operatorname{arcsch} x$
 Domain: $(-\infty, 0)$ and $(0, \infty)$
 Range: $(-\infty, 0)$ and $(0, \infty)$

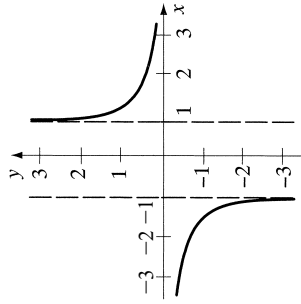

$y = \operatorname{arcoth} x$
 Domain: $(-\infty, -1)$ and $(1, \infty)$
 Range: $(-\infty, 0)$ and $(0, \infty)$

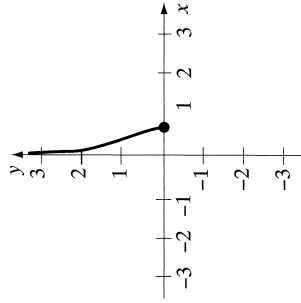

$y = \operatorname{arcsech} x$
 Domain: $(0, 1]$
 Range: $[0, \infty)$

Figure 2.9. Graphs of inverse hyperbolic functions.

$$3. \quad \arctan(\tan x) = x - n\pi \quad \left[n\pi - \frac{1}{2}\pi < x < n\pi + \frac{1}{2}\pi \right]$$

$$4. \quad \operatorname{arccot}(\cot x) = x - n\pi \quad [n\pi < x < (n+1)\pi]$$

2.7.2.2 Relationships Between Inverse Trigonometric Functions, Inverse Hyperbolic Functions, and the Logarithm

$$1. \quad \arcsin z = \frac{1}{i} \ln(iz + \sqrt{1-z^2}) = \frac{1}{i} \operatorname{arcsinh}(iz)$$

$$2. \quad \arccos z = \frac{1}{i} \ln(z + \sqrt{z^2-1}) = \frac{1}{i} \operatorname{arccosh} z$$

$$3. \quad \arctan z = \frac{1}{2i} \ln\left(\frac{1+iz}{1-iz}\right) = \frac{1}{i} \operatorname{arctanh}(iz)$$

$$4. \quad \operatorname{arccot} z = \frac{1}{2i} \ln\left(\frac{iz-1}{iz+1}\right) = i \operatorname{arccoth}(iz)$$

$$5. \quad \operatorname{arcsinh} z = \ln(z + \sqrt{z^2+1}) = \frac{1}{i} \arcsin(iz)$$

$$6. \quad \operatorname{arccosh} z = \ln(z + \sqrt{z^2-1}) = i \arccos z$$

$$7. \quad \operatorname{arctanh} z = \frac{1}{2} \ln\left(\frac{1+z}{1-z}\right) = \frac{1}{i} \arctan(iz)$$

$$8. \quad \operatorname{arccoth} z = \frac{1}{2} \ln\left(\frac{z+1}{z-1}\right) = \frac{1}{i} \operatorname{arccot}(-iz)$$

2.7.2.3 Relationships Between Different Inverse Trigonometric Functions

$$1. \quad \arcsin x + \arccos x = \frac{\pi}{2}$$

$$2. \quad \operatorname{arctg} x + \operatorname{arctg} x = \frac{\pi}{2}$$

2.7.2.4

$$1. \quad \arcsin x = \arccos \sqrt{1-x^2} \quad [0 \leq x \leq 1]$$

$$= -\arccos \sqrt{1-x^2} \quad [-1 \leq x \leq 0]$$

$$2. \quad \arcsin x = \arctan \frac{x}{\sqrt{1-x^2}} \quad [x^2 < 1]$$

$$\begin{aligned}
 3. \quad \arcsin x &= \operatorname{arccot} \frac{\sqrt{1-x^2}}{x} \quad [0 < x \leq 1] \\
 &= \operatorname{arccot} \frac{\sqrt{1-x^2}}{x} - \pi \quad [-1 \leq x < 0]
 \end{aligned}$$

$$\begin{aligned}
 4. \quad \arccos x &= \arcsin \sqrt{1-x^2} \quad [0 \leq x \leq 1] \\
 &= \pi - \arcsin \sqrt{1-x^2} \quad [-1 \leq x \leq 0]
 \end{aligned}$$

$$\begin{aligned}
 5. \quad \arccos x &= \arctan \frac{\sqrt{1-x^2}}{x} \quad [0 < x \leq 1] \\
 &= \pi + \operatorname{arccot} \frac{\sqrt{1-x^2}}{x} \quad [-1 \leq x < 0]
 \end{aligned}$$

$$6. \quad \arccos x = \operatorname{arccot} \frac{x}{\sqrt{1-x^2}} \quad [-1 \leq x < 1]$$

$$7. \quad \arctan x = \arcsin \frac{x}{\sqrt{1+x^2}} \quad [-\infty < x < \infty]$$

$$\begin{aligned}
 8. \quad \arctan x &= \arccos \frac{1}{\sqrt{1+x^2}} \quad [x \geq 0] \\
 &= -\arccos \frac{1}{\sqrt{1+x^2}} \quad [x \leq 0]
 \end{aligned}$$

$$\begin{aligned}
 9. \quad \arctan x &= \operatorname{arccot} \frac{1}{x} \quad [x > 0] \\
 &= -\operatorname{arccot} \frac{1}{x} - \pi \quad [x < 0]
 \end{aligned}$$

$$\begin{aligned}
 10. \quad \arctan x &= \arcsin \frac{1}{\sqrt{1+x^2}} \quad [x > 0] \\
 &= \pi - \arcsin \frac{1}{\sqrt{1+x^2}} \quad [x < 0]
 \end{aligned}$$

$$11. \quad \operatorname{arccot} x = \arccos \frac{x}{\sqrt{1+x^2}}$$

$$\begin{aligned}
 12. \quad \operatorname{arccot} x &= \arctan \frac{1}{x} \quad [x > 0] \\
 &= \pi + \arctan \frac{1}{x} \quad [x < 0]
 \end{aligned}$$

2.7.2.5 Relationships Between the Inverse Hyperbolic Functions

$$1. \quad \operatorname{arsinh} x = \operatorname{arccosh} \sqrt{x^2 + 1} = \operatorname{arctanh} \frac{x}{\sqrt{x^2 + 1}}$$

2. $\operatorname{arccosh} x = \operatorname{arcsinh} \sqrt{x^2 - 1} = \operatorname{arctanh} \frac{\sqrt{x^2 - 1}}{x}$
3. $\operatorname{arctanh} x = \operatorname{arcsinh} \frac{x}{\sqrt{1 - x^2}} = \operatorname{arccosh} \frac{1}{\sqrt{1 - x^2}} = \operatorname{arccoth} \frac{1}{x}$
4. $\operatorname{arcsinh} x \pm \operatorname{arcsinh} y = \operatorname{arcsinh} \left(x\sqrt{1 + y^2} \pm y\sqrt{1 + x^2} \right)$
5. $\operatorname{arccosh} x \pm \operatorname{arccosh} y = \operatorname{arccosh} \left(xy \pm \sqrt{(x^2 - 1)(y^2 - 1)} \right)$
6. $\operatorname{arctanh} x \pm \operatorname{arctanh} y = \operatorname{arctanh} \frac{x \pm y}{1 \pm xy}$

2.8 SERIES REPRESENTATIONS OF TRIGONOMETRIC AND HYPERBOLIC FUNCTIONS

2.8.1 Trigonometric Functions

2.8.1.1

1. $\sin x = x - \frac{x^3}{3!} + \frac{x^5}{5!} - \frac{x^7}{7!} + \cdots = \sum_{k=0}^{\infty} (-1)^k \frac{x^{2k+1}}{(2k+1)!}$
2. $\cos x = 1 - \frac{x^2}{2!} + \frac{x^4}{4!} - \frac{x^6}{6!} + \cdots = \sum_{k=0}^{\infty} (-1)^k \frac{x^{2k}}{(2k)!}$
3. $\tan x = x + \frac{x^3}{3} + \frac{2}{15}x^5 + \frac{17}{315}x^7 + \cdots = \sum_{k=1}^{\infty} (-1)^{k+1} \frac{2^{2k}(2^{2k}-1)}{(2k)!} B_{2k} x^{2k-1}$
 $\left[|x| < \frac{\pi}{2}; \text{ see 1.3.1.4.3} \right]$
4. $\csc x = \frac{1}{x} + \frac{x}{6} + \frac{7}{360}x^3 + \frac{31}{51120}x^5 + \cdots$
 $= \frac{1}{x} + \sum_{k=1}^{\infty} \frac{2(2^{2k-1}-1)|B_{2k}|}{(2k)!} x^{2k-1} \quad [|x| < \pi]$
5. $\sec x = 1 + \frac{x^2}{2} + \frac{5}{24}x^4 + \frac{61}{720}x^6 + \cdots$
 $= 1 + \sum_{k=1}^{\infty} \frac{E_{2k}}{(2k)!} x^{2k} \quad \left[|x| < \frac{\pi}{2}; \text{ see 1.3.1.1.5} \right]$
6. $\cot x = \frac{1}{x} - \frac{x}{3} - \frac{x^3}{45} - \frac{2x^5}{945} - \cdots$
 $= \frac{1}{x} - \sum_{k=1}^{\infty} \frac{2^{2k}|B_{2k}|}{(2k)!} x^{2k-1} \quad [|x| < \pi]$

$$7. \quad \sin^2 x = x^2 - \frac{x^4}{3} + \frac{2x^6}{45} - \frac{x^8}{315} + \cdots = \sum_{k=1}^{\infty} (-1)^{k+1} \frac{2^{2k-1} x^{2k}}{(2k)!}$$

$$8. \quad \cos^2 x = 1 - x^2 + \frac{x^4}{3} - \frac{2x^6}{45} + \frac{x^8}{315} - \cdots = 1 - \sum_{k=1}^{\infty} (-1)^{k+1} \frac{2^{2k-1} x^{2k}}{(2k)!}$$

$$9. \quad \tan^2 x = x^2 + \frac{2x^4}{3} + \frac{17}{45}x^6 + \frac{62}{315}x^8 + \cdots \quad \left[|x| < \frac{\pi}{2}\right]$$

2.8.2 Hyperbolic Functions

2.8.2.1

$$1. \quad \sinh x = x + \frac{x^3}{3!} + \frac{x^5}{5!} + \frac{x^7}{7!} + \cdots = \sum_{k=0}^{\infty} \frac{x^{2k+1}}{(2k+1)!}$$

$$2. \quad \cosh x = 1 + \frac{x^2}{2!} + \frac{x^4}{4!} + \frac{x^6}{6!} + \cdots = \sum_{k=0}^{\infty} \frac{x^{2k}}{(2k)!}$$

$$3. \quad \tanh x = x - \frac{x^3}{3} + \frac{2}{15}x^5 - \frac{17}{315}x^7 + \cdots = \sum_{k=1}^{\infty} \frac{2^{2k} (2^{2k} - 1)}{(2k)!} B_{2k} x^{2k-1} \quad \left[|x| < \frac{\pi}{2}\right]$$

$$4. \quad \operatorname{csch} x = \frac{1}{x} - \frac{x}{6} + \frac{7}{360}x^3 - \frac{31}{15120}x^5 + \cdots = \frac{1}{x} - \sum_{k=1}^{\infty} \frac{2(2^{2k-1} - 1) B_{2k}}{(2k)!} x^{2k-1} \quad [|x| < \pi]$$

$$5. \quad \operatorname{sech} x = 1 - \frac{x^2}{2!} + \frac{5}{4!}x^4 - \frac{61}{6!}x^6 + \cdots = 1 + \sum_{k=1}^{\infty} \frac{E_{2k}}{(2k)!} x^{2k} \quad \left[|x| < \frac{\pi}{2}\right]$$

$$6. \quad \operatorname{coth} x = \frac{1}{x} + \frac{x}{3} - \frac{x^3}{45} + \frac{2}{945}x^5 - \cdots = \frac{1}{x} + \sum_{k=1}^{\infty} \frac{2^{2k} B_{2k}}{(2k)!} x^{2k-1} \quad [|x| < \pi]$$

$$7. \quad \sinh^2 x = x^2 + \frac{x^4}{3} + \frac{2x^6}{45} + \frac{x^8}{315} + \cdots = \sum_{k=1}^{\infty} \frac{2^{2k-1} x^{2k}}{(2k)!}$$

$$8. \quad \cosh^2 x = 1 + x^2 + \frac{x^4}{3} + \frac{2x^6}{45} + \frac{x^8}{315} + \cdots = 1 + \sum_{k=1}^{\infty} \frac{2^{2k-1} x^{2k}}{(2k)!}$$

$$9. \quad \tanh^2 x = x^2 - \frac{2x^4}{3} + \frac{17}{45}x^6 - \frac{62}{315}x^8 + \cdots$$

2.8.3 Inverse Trigonometric Functions

2.8.3.1

$$1. \quad \arcsin x = x + \frac{1}{2 \cdot 3}x^3 + \frac{1 \cdot 3}{2 \cdot 4 \cdot 5}x^5 + \frac{1 \cdot 3 \cdot 5}{2 \cdot 4 \cdot 6 \cdot 7}x^7 + \dots$$

$$= \sum_{k=0}^{\infty} \frac{(2k)! x^{2k+1}}{2^{2k} (k!)^2 (2k+1)} \quad [|x| < 1]$$

$$2. \quad \arccos x = \frac{\pi}{2} - \left(x + \frac{x^3}{2 \cdot 3} + \frac{1 \cdot 3}{2 \cdot 4 \cdot 5}x^5 + \frac{1 \cdot 3 \cdot 5}{2 \cdot 4 \cdot 6 \cdot 7}x^7 + \dots \right)$$

$$= \frac{\pi}{2} - \sum_{k=0}^{\infty} \frac{(2k)! x^{2k+1}}{2^{2k} (k!)^2 (2k+1)} \quad [|x| < 1]$$

$$3. \quad \arctan x = x - \frac{x^3}{3} + \frac{x^5}{5} - \frac{x^7}{7} + \dots = \sum_{k=0}^{\infty} \frac{(-1)^k x^{2k+1}}{2k+1} \quad [|x| < 1]$$

[obtained by integrating $1/(1+x^2)$; see 0.7.3]

$$4. \quad \arctan x = \frac{\pi}{2} - \frac{1}{x} + \frac{1}{3x^3} - \frac{1}{5x^5} + \frac{1}{7x^7} - \dots = \frac{\pi}{2} - \sum_{k=0}^{\infty} (-1)^k \frac{1}{(2k+1)x^{2k+1}} \quad [x^2 \geq 1]$$

$$5. \quad \arctan x = \frac{x}{\sqrt{1+x^2}} \left\{ 1 + \frac{1}{6} \left(\frac{x^2}{1+x^2} \right) + \frac{3}{40} \left(\frac{x^2}{1+x^2} \right)^2 \right. \\ \left. + \frac{5}{112} \left(\frac{x^2}{1+x^2} \right)^3 + \dots \right\}$$

$$= \frac{x}{\sqrt{1+x^2}} \sum_{k=0}^{\infty} \frac{(2k)!}{2^{2k} (k!)^2 (2k+1)} \left(\frac{x^2}{1+x^2} \right)^k \quad [x^2 < \infty]$$

$$6. \quad \operatorname{arcsec} x = \frac{\pi}{2} - \frac{1}{x} - \frac{1}{2 \cdot 3x^3} - \frac{1 \cdot 3}{2 \cdot 4 \cdot 5x^5} - \dots = \frac{\pi}{2} - \sum_{k=0}^{\infty} \frac{(2k)! x^{-(2k+1)}}{(k!)^2 2^{2k} (2k+1)} \quad [x^2 > 1]$$

$$7. \quad \operatorname{arccsc} x = \frac{1}{x} + \frac{1}{2 \cdot 3x^3} + \frac{1 \cdot 3}{2 \cdot 4 \cdot 5x^5} + \dots = \sum_{k=0}^{\infty} \frac{(2k)! x^{-(2k+1)}}{(k!)^2 2^{2k} (2k+1)} \quad [x^2 > 1]$$

2.8.4 Inverse Hyperbolic Functions

2.8.4.1

$$1. \quad \operatorname{arsinh} x = x - \frac{1}{2 \cdot 3}x^3 + \frac{1 \cdot 3}{2 \cdot 4 \cdot 5}x^5 - \dots = \sum_{k=0}^{\infty} (-1)^k \frac{(2k)! x^{2k+1}}{2^{2k} (k!)^2 (2k+1)}$$

$$= \ln \left[x + \sqrt{(x^2+1)} \right] \quad [|x| \leq 1]$$

2. $\operatorname{arcsinh} x = \ln 2x + \frac{1}{2} \frac{1}{2x^2} - \frac{1 \cdot 3}{2 \cdot 4} \frac{1}{4x^4} + \cdots = \ln 2x + \sum_{k=1}^{\infty} (-1)^{k+1} \frac{(2k)!}{2^{2k} (k!)^2} \frac{x^{-2k}}{2k} \quad [x \geq 1]$
3. $\operatorname{arcsinh} x = -\ln |2x| - \frac{1}{2} \cdot \frac{1}{2x^2} + \frac{1 \cdot 3}{2 \cdot 4} \frac{1}{4x^4} - \cdots$
 $= -\ln |2x| - \sum_{k=1}^{\infty} (-1)^{k+1} \frac{(2k)!}{2^{2k} (k!)^2} \frac{x^{-2k}}{2k} \quad [x < -1]$
4. $\operatorname{arccosh} x = \ln 2x - \frac{1}{2} \frac{1}{2x^2} - \frac{1 \cdot 3}{2 \cdot 4} \frac{1}{4x^4} - \cdots = \ln 2x - \sum_{k=1}^{\infty} \frac{(2k)!}{2^{2k} (k!)^2} \frac{x^{-2k}}{2k}$
 $= \ln \left[x + \sqrt{(x^2 - 1)} \right] \quad [x \geq 1]$
5. $\operatorname{arctanh} x = x + \frac{x^3}{3} + \frac{x^5}{5} + \frac{x^7}{7} + \cdots = \sum_{k=0}^{\infty} \frac{x^{2k+1}}{2k+1}$
 $= \frac{1}{2} \ln \left(\frac{1+x}{1-x} \right) \quad [|x| < 1]$
6. $\operatorname{arccoth} x = \frac{1}{x} + \frac{1}{3x^3} + \frac{1}{5x^5} + \frac{1}{7x^7} + \cdots = \sum_{k=0}^{\infty} \frac{1}{(2k+1)x^{2k+1}}$
 $= \frac{1}{2} \ln \left(\frac{x+1}{x-1} \right) \quad [|x| > 1]$

2.9 USEFUL LIMITING VALUES AND INEQUALITIES INVOLVING ELEMENTARY FUNCTIONS

2.9.1 Logarithmic Functions

1. $\frac{x}{1+x} < \ln(1+x) < x \quad [x \neq 0, -1 < x]$
2. $x < -\ln(1-x) < \frac{x}{1-x} \quad [x \neq 0, x < 1]$
3. $\lim_{x \rightarrow \infty} [x^{-\alpha} \ln x] = 0 \quad [\alpha > 0]$
4. $\lim_{x \rightarrow 0} [x^{\alpha} \ln x] = 0 \quad [\alpha > 0]$

2.9.2 Exponential Functions

1. $1+x \leq e^x$
2. $e^x < \frac{1}{1-x} \quad [x < 1]$

3. $\left(1 + \frac{x}{n}\right)^n < e^x \quad [n > 0]$
4. $\frac{x}{1+x} < 1 - e^{-x} < x \quad [-1 < x]$
5. $x < e^x - 1 < \frac{x}{1-x} \quad [x < 1]$
6. $\lim_{x \rightarrow \infty} (x^\alpha e^{-x}) = 0$
7. $\lim_{n \rightarrow \infty} \left(1 + \frac{x}{n}\right)^n = e^x$

2.9.3 Trigonometric and Hyperbolic Functions

1. $\frac{\sin x}{x} > \frac{2}{\pi} \quad [|x| < \pi/2]$
2. $\sin x \leq x \leq \tan x \quad [0 \leq x < \pi/2]$
3. $\cos x \leq \frac{\sin x}{x} \leq 1 \quad [0 \leq x \leq \pi]$
4. $\cot x \leq \frac{1}{x} \leq \operatorname{cosec} x \quad [0 \leq x \leq \pi/2]$

If $z = x + iy$, then:

5. $|\sinh y| \leq |\sin z| \leq \cosh y$
6. $|\sinh y| \leq |\cos z| \leq \cosh y$
7. $|\sin z| \leq \sinh |z|$
8. $|\cos z| \leq \cosh |z|$
9. $\sin |x| \leq |\cosh z| \leq \cosh x$
10. $\sinh |x| \leq |\sinh z| \leq \cosh x$
11. $\lim_{x \rightarrow 0} \left(\frac{\sin kx}{x} \right) = k$
12. $\lim_{x \rightarrow 0} \left(\frac{\tan kx}{x} \right) = k$
13. $\lim_{n \rightarrow \infty} \left(n \sin \frac{x}{n} \right) = x$
14. $\lim_{n \rightarrow \infty} \left(n \tan \frac{x}{n} \right) = x$

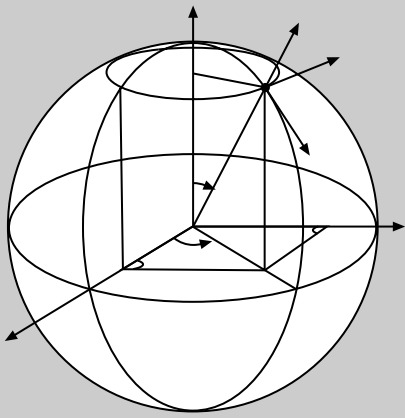

Chapter 3

Derivatives of Elementary Functions

3.1 DERIVATIVES OF ALGEBRAIC, LOGARITHMIC, AND EXPONENTIAL FUNCTIONS

3.1.1

Let $u(x)$ be a differentiable function with respect to x , and α , a and k be constants.

$$1. \quad \frac{d}{dx}[x^\alpha] = \alpha x^{\alpha-1}$$

$$2. \quad \frac{d}{dx}[u^\alpha] = \alpha u^{\alpha-1} \frac{du}{dx}$$

$$3. \quad \frac{d}{dx}[x^{1/2}] = \frac{1}{2x^{1/2}}$$

$$4. \quad \frac{d}{dx}[u^{1/2}] = \frac{1}{2u^{1/2}} \frac{du}{dx}$$

$$5. \quad \frac{d}{dx}[x^{-\alpha}] = -\frac{\alpha}{x^{\alpha+1}}$$

$$6. \quad \frac{d}{dx}[u^{-\alpha}] = -\frac{\alpha}{u^{\alpha+1}} \frac{du}{dx}$$

$$7. \quad \frac{d}{dx}[\ln x] = \frac{1}{x}$$

$$8. \quad \frac{d}{dx}[\ln u] = \frac{1}{u} \frac{du}{dx}$$

$$9. \quad \frac{d^n}{dx^n}[\ln x] = \frac{(-1)^{n-1} (n-1)!}{x^n}$$

$$10. \quad \frac{d^2}{dx^2}[\ln u] = -\frac{1}{u^2} \left(\frac{du}{dx}\right)^2 + \frac{1}{u} \frac{d^2 u}{dx^2}$$

$$11. \quad \frac{d}{dx}[x \ln x] = \ln x + 1$$

$$12. \quad \frac{d}{dx}[x \ln u] = \ln u + \frac{x}{u} \frac{du}{dx}$$

$$13. \quad \frac{d}{dx}[x^n \ln x] = (n \ln x + 1)x^{n-1}$$

$$14. \quad \frac{d}{dx}[u \ln u] = (\ln u + 1) \frac{du}{dx}$$

15. $\frac{d}{dx}[e^x] = e^x$ 16. $\frac{d}{dx}[e^{kx}] = ke^{kx}$
 17. $\frac{d}{dx}[e^u] = e^u \frac{du}{dx}$ 18. $\frac{d}{dx}[a^x] = a^x \ln a$
 19. $\frac{d}{dx}[a^u] = a^u (\ln a) \frac{du}{dx}$ 20. $\frac{d}{dx}[x^x] = (1 + \ln x)x^x$

3.2 DERIVATIVES OF TRIGONOMETRIC FUNCTIONS

3.2.1

Let $u(x)$ be a differentiable function with respect to x .

1. $\frac{d}{dx}[\sin x] = \cos x$ 2. $\frac{d}{dx}[\sin u] = \cos u \frac{du}{dx}$
 3. $\frac{d}{dx}[\cos x] = -\sin x$ 4. $\frac{d}{dx}[\cos u] = -\sin u \frac{du}{dx}$
 5. $\frac{d}{dx}[\tan x] = \sec^2 x$ 6. $\frac{d}{dx}[\tan u] = \sec^2 u \frac{du}{dx}$
 7. $\frac{d}{dx}[\csc x] = -\csc x \cot x$ 8. $\frac{d}{dx}[\csc u] = -\csc u \cot u \frac{du}{dx}$
 9. $\frac{d}{dx}[\sec x] = \sec x \tan x$ 10. $\frac{d}{dx}[\sec u] = \sec u \tan u \frac{du}{dx}$
 11. $\frac{d}{dx}[\cot x] = -\csc^2 x$ 12. $\frac{d}{dx}[\cot u] = -\csc^2 u \frac{du}{dx}$
 13. $\frac{d^n}{dx^n}[\sin x] = \sin\left(x + \frac{1}{2}n\pi\right)$ 14. $\frac{d^n}{dx^n}[\cos x] = \cos\left(x + \frac{1}{2}n\pi\right)$

3.3 DERIVATIVES OF INVERSE TRIGONOMETRIC FUNCTIONS

3.3.1

Let $u(x)$ be a differentiable function with respect to x .

1. $\frac{d}{dx}\left[\arcsin \frac{x}{a}\right] = \frac{1}{(a^2 - x^2)^{1/2}} \quad \left[-\frac{\pi}{2} < \arcsin \frac{x}{a} < \frac{\pi}{2}\right]$
 2. $\frac{d}{dx}\left[\arcsin \frac{u}{a}\right] = \frac{1}{(a^2 - u^2)^{1/2}} \frac{du}{dx} \quad \left[-\frac{\pi}{2} < \arcsin \frac{u}{a} < \frac{\pi}{2}\right]$
 3. $\frac{d}{dx}\left[\arccos \frac{x}{a}\right] = \frac{-1}{(a^2 - x^2)^{1/2}} \quad \left[0 < \arccos \frac{x}{a} < \pi\right]$
 4. $\frac{d}{dx}\left[\arccos \frac{u}{a}\right] = \frac{-1}{(a^2 - u^2)^{1/2}} \frac{du}{dx} \quad \left[0 < \arccos \frac{u}{a} < \pi\right]$

5. $\frac{d}{dx} \left[\arctan \frac{x}{a} \right] = \frac{a}{a^2 + x^2}$
6. $\frac{d}{dx} \left[\arctan \frac{u}{a} \right] = \frac{a}{a^2 + u^2} \frac{du}{dx}$
7. $\frac{d}{dx} \left[\operatorname{arccsc} \frac{x}{a} \right] = \frac{-a}{x(x^2 - a^2)^{1/2}} \quad \left[0 < \operatorname{arccsc} \frac{x}{a} < \frac{\pi}{2} \right]$
8. $\frac{d}{dx} \left[\operatorname{arccsc} \frac{x}{a} \right] = \frac{a}{x(x^2 - a^2)^{1/2}} \quad \left[-\frac{\pi}{2} < \operatorname{arccsc} \frac{x}{a} < 0 \right]$
9. $\frac{d}{dx} \left[\operatorname{arccsc} \frac{u}{a} \right] = \frac{-a}{u(u^2 - a^2)^{1/2}} \frac{du}{dx} \quad \left[0 < \operatorname{arccsc} \frac{u}{a} < \frac{\pi}{2} \right]$
10. $\frac{d}{dx} \left[\operatorname{arccsc} \frac{u}{a} \right] = \frac{a}{u(u^2 - a^2)^{1/2}} \frac{du}{dx} \quad \left[-\frac{\pi}{2} < \operatorname{arccsc} \frac{u}{a} < 0 \right]$
11. $\frac{d}{dx} \left[\operatorname{arcsec} \frac{x}{a} \right] = \frac{a}{x(x^2 - a^2)^{1/2}} \quad \left[0 < \operatorname{arcsec} \frac{x}{a} < \frac{\pi}{2} \right]$
12. $\frac{d}{dx} \left[\operatorname{arcsec} \frac{x}{a} \right] = \frac{-a}{x(x^2 - a^2)^{1/2}} \quad \left[\frac{\pi}{2} < \operatorname{arcsec} \frac{x}{a} < \pi \right]$
13. $\frac{d}{dx} \left[\operatorname{arcsec} \frac{u}{a} \right] = \frac{a}{u(u^2 - a^2)^{1/2}} \frac{du}{dx} \quad \left[0 < \operatorname{arcsec} \frac{u}{a} < \frac{\pi}{2} \right]$
14. $\frac{d}{dx} \left[\operatorname{arcsec} \frac{u}{a} \right] = \frac{-a}{u(u^2 - a^2)^{1/2}} \frac{du}{dx} \quad \left[\frac{\pi}{2} < \operatorname{arcsec} \frac{u}{a} < \pi \right]$

3.4 DERIVATIVES OF HYPERBOLIC FUNCTIONS

3.4.1

Let $u(x)$ be a differentiable function with respect to x .

1. $\frac{d}{dx} [\sinh x] = \cosh x$
2. $\frac{d}{dx} [\sinh u] = \cosh u \frac{du}{dx}$
3. $\frac{d}{dx} [\cosh x] = \sinh x$
4. $\frac{d}{dx} [\cosh u] = \sinh u \frac{du}{dx}$
5. $\frac{d}{dx} [\tanh x] = \operatorname{sech}^2 x$
6. $\frac{d}{dx} [\tanh u] = \operatorname{sech}^2 u \frac{du}{dx}$
7. $\frac{d}{dx} [\operatorname{csch} x] = -\operatorname{csch} x \coth x$
8. $\frac{d}{dx} [\operatorname{csch} u] = -\operatorname{csch} u \coth u \frac{du}{dx}$
9. $\frac{d}{dx} [\operatorname{sech} x] = -\operatorname{sech} x \tanh x$
10. $\frac{d}{dx} [\operatorname{sech} u] = -\operatorname{sech} u \tanh u \frac{du}{dx}$
11. $\frac{d}{dx} [\operatorname{coth} x] = -\operatorname{csch}^2 x + 2\delta(x)$
12. $\frac{d}{dx} [\operatorname{coth} u] = -[\operatorname{csch}^2 u + 2\delta(u)] \frac{du}{dx}$

The delta function occurs because of the discontinuity in the coth function at the origin.

3.5 DERIVATIVES OF INVERSE HYPERBOLIC FUNCTIONS

3.5.1

Let $u(x)$ be a differentiable function with respect to x

1. $\frac{d}{dx} \left[\operatorname{arcsinh} \frac{x}{a} \right] = \frac{1}{(x^2 + a^2)^{1/2}}$
2. $\frac{d}{dx} \left[\operatorname{arcsinh} \frac{u}{a} \right] = \frac{1}{(u^2 + a^2)^{1/2}} \frac{du}{dx}$
3. $\frac{d}{dx} \left[\operatorname{arcosh} \frac{x}{a} \right] = \frac{1}{(x^2 - a^2)^{1/2}} \left[\frac{x}{a} > 1, \operatorname{arcosh} \frac{x}{a} > 0 \right]$
4. $\frac{d}{dx} \left[\operatorname{arcosh} \frac{x}{a} \right] = \frac{-1}{(x^2 - a^2)^{1/2}} \left[\frac{x}{a} > 1, \operatorname{arcosh} \frac{x}{a} < 0 \right]$
5. $\frac{d}{dx} \left[\operatorname{arcosh} \frac{u}{a} \right] = \frac{1}{(u^2 - a^2)^{1/2}} \frac{du}{dx} \left[\frac{u}{a} > 1, \operatorname{arcosh} \frac{u}{a} > 0 \right]$
6. $\frac{d}{dx} \left[\operatorname{arcosh} \frac{u}{a} \right] = \frac{-1}{(u^2 - a^2)^{1/2}} \frac{du}{dx} \left[\frac{u}{a} > 1, \operatorname{arcosh} \frac{u}{a} < 0 \right]$
7. $\frac{d}{dx} \left[\operatorname{artanh} \frac{x}{a} \right] = \frac{a}{a^2 - x^2} \quad [x^2 < a^2]$
8. $\frac{d}{dx} \left[\operatorname{artanh} \frac{u}{a} \right] = \frac{a}{a^2 - u^2} \frac{du}{dx} \quad [u^2 < a^2]$
9. $\frac{d}{dx} \left[\operatorname{arcsch} \frac{x}{a} \right] = \frac{-a}{|x| (x^2 + a^2)^{1/2}} \quad [x \neq 0]$
10. $\frac{d}{dx} \left[\operatorname{arcsch} \frac{u}{a} \right] = \frac{-a}{|u| (u^2 + a^2)^{1/2}} \frac{du}{dx} \quad [u \neq 0]$
11. $\frac{d}{dx} \left[\operatorname{arcsech} \frac{x}{a} \right] = \frac{-a}{x (a^2 - x^2)^{1/2}} \quad \left[0 < \frac{x}{a} < 1, \operatorname{arcsech} \frac{x}{a} > 0 \right]$
12. $\frac{d}{dx} \left[\operatorname{arcsech} \frac{x}{a} \right] = \frac{a}{x (a^2 - x^2)^{1/2}} \quad \left[0 < \frac{x}{a} < 1, \operatorname{arcsech} \frac{x}{a} < 0 \right]$
13. $\frac{d}{dx} \left[\operatorname{arcsech} \frac{u}{a} \right] = \frac{-a}{u (a^2 - u^2)^{1/2}} \frac{du}{dx} \quad \left[0 < \frac{u}{a} < 1, \operatorname{arcsech} \frac{u}{a} > 0 \right]$
14. $\frac{d}{dx} \left[\operatorname{arcsech} \frac{u}{a} \right] = \frac{a}{u (a^2 - u^2)^{1/2}} \frac{du}{dx} \quad \left[0 < \frac{u}{a} < 1, \operatorname{arcsech} \frac{u}{a} < 0 \right]$
15. $\frac{d}{dx} \left[\operatorname{arcoth} \frac{x}{a} \right] = \frac{a}{a^2 - x^2} \quad [x^2 > a^2]$
16. $\frac{d}{dx} \left[\operatorname{arcoth} \frac{u}{a} \right] = \frac{a}{a^2 - u^2} \frac{du}{dx} \quad [u^2 > a^2]$

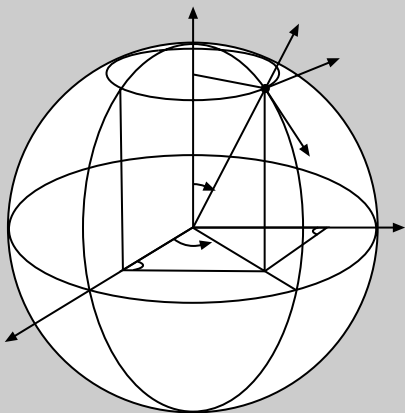

Chapter 4

Indefinite Integrals of Algebraic Functions

4.1 ALGEBRAIC AND TRANSCENDENTAL FUNCTIONS

4.1.1 Definitions

4.1.1.1

A function $f(x)$ is said to be **algebraic** if a polynomial $P(x, y)$ in the two variables x, y can be found with the property that $P(x, f(x)) = 0$ for all x for which $f(x)$ is defined. Thus, the function

$$f(x) = x^2 - (1 - x^4)^{1/2}$$

is an *algebraic function*, because the polynomial

$$P(x, y) = y^2 - 2x^2y + 2x^4 - 1$$

has the necessary property.

Functions that are not algebraic are called **transcendental functions**. Examples of transcendental functions are

$$f(x) = \sin x, \quad f(x) = e^x + \ln x, \quad \text{and} \quad f(x) = \tan x + (1 - x^2)^{1/2}.$$

A fundamental difference between algebraic and transcendental functions is that whereas algebraic functions can only have a finite number of zeros, a transcendental function can have an infinite number. Thus, for example, $\sin x$ has zeros at $x = \pm n\pi$, $n = 0, 1, 2, \dots$

Transcendental functions arise in many different ways, one of which is as a result of integrating algebraic functions in, for example, the following cases:

$$\int \frac{dx}{x} = \ln x, \quad \int \frac{dx}{(x^2 - a^2)^{1/2}} = \ln \left| x + (x^2 - a^2)^{1/2} \right|, \quad \text{and}$$

$$\int \frac{dx}{x^2 + a^2} = \frac{1}{a} \arctan\left(\frac{x}{a}\right).$$

Within the class of algebraic functions there is an important and much simpler subclass called **rational functions**. A function $f(x)$ is said to be a **rational function** if

$$f(x) = \frac{P(x)}{Q(x)},$$

where $P(x)$ and $Q(x)$ are both polynomials (see 1.7.1.1). These simple algebraic functions can be integrated by first expressing their integrands in terms of partial fractions (see 1.7), and then integrating the result term by term. Hereafter, for convenience of reference, indefinite integrals will be classified according to their integrands as rational functions, nonrational (irrational) algebraic functions, or transcendental functions.

4.2 INDEFINITE INTEGRALS OF RATIONAL FUNCTIONS

4.2.1 Integrands Involving x^n

4.2.1.1

$$1. \quad \int dx = x$$

$$2. \quad \int x dx = \frac{1}{2}x^2$$

$$3. \quad \int x^2 dx = \frac{1}{3}x^3$$

$$4. \quad \int x^n dx = \frac{x^{n+1}}{n+1} \quad [n \neq -1]$$

$$5. \quad \int \frac{dx}{x} = \ln|x|$$

$$6. \quad \int \frac{dx}{x^2} = -\frac{1}{x}$$

$$7. \quad \int \frac{dx}{x^3} = -\frac{1}{2x^2}$$

$$8. \quad \int \frac{dx}{x^n} = -\frac{1}{(n-1)x^{n-1}} \quad [n \neq 1]$$

4.2.2 Integrands Involving $a + bx$

4.2.2.1

$$1. \quad \int (a + bx)^n dx = \frac{(a + bx)^{n+1}}{b(n+1)} \quad [n \neq -1]$$

$$2. \quad \int \frac{dx}{a + bx} = \frac{1}{b} \ln|a + bx|$$

$$3. \int \frac{dx}{(a+bx)^2} = -\frac{1}{b(a+bx)}$$

$$4. \int \frac{dx}{(a+bx)^3} = -\frac{1}{2b(a+bx)^2}$$

$$5. \int \frac{dx}{(a+bx)^n} = -\frac{1}{b(n-1)(a+bx)^{n-1}} \quad [n \neq 1]$$

4.2.2.2

$$1. \int \frac{x dx}{a+bx} = \frac{x}{b} - \frac{a}{b^2} \ln|a+bx| \quad (\text{see 4.2.2.6.1})$$

$$2. \int \frac{x dx}{(a+bx)^2} = -\frac{x}{b(a+bx)} + \frac{1}{b^2} \ln|a+bx| \quad (\text{see 4.2.2.6.2})$$

$$3. \int \frac{x dx}{(a+bx)^3} = -\left(\frac{x}{b} + \frac{a}{2b^2}\right) \frac{1}{(a+bx)^2}$$

$$4. \int \frac{x dx}{(a+bx)^n} = \frac{x}{b(2-n)(a+bx)^{n-1}} - \frac{a}{b(2-n)} \int \frac{dx}{(a+bx)^n}$$

[reduction formula for $n \neq 2$]

4.2.2.3

$$1. \int \frac{x^2 dx}{a+bx} = \frac{x^2}{2b} - \frac{ax}{b^2} + \frac{a^2}{b^3} \ln|a+bx| \quad (\text{see 4.2.2.6.1})$$

$$2. \int \frac{x^2 dx}{(a+bx)^2} = \frac{x}{b^2} - \frac{a^2}{b^3(a+bx)} - \frac{2a}{b^3} \ln|a+bx| \quad (\text{see 4.2.2.6.2})$$

$$3. \int \frac{x^2 dx}{(a+bx)^3} = \left(\frac{2ax}{b^2} + \frac{3a^2}{2b^3}\right) \frac{1}{(a+bx)^2} + \frac{1}{b^3} \ln|a+bx|$$

$$4. \int \frac{x^2 dx}{(a+bx)^n} = \frac{x^2}{b(3-n)(a+bx)^{n-1}} - \frac{2a}{b(3-n)} \int \frac{x dx}{(a+bx)^n}$$

[reduction formula for $n \neq 3$]

4.2.2.4

$$1. \int \frac{x^3 dx}{a+bx} = \frac{x^3}{3b} - \frac{ax^2}{2b^2} + \frac{a^2x}{b^3} - \frac{a^3}{b^4} \ln|a+bx| \quad (\text{see 4.2.2.6.1})$$

$$2. \int \frac{x^3 dx}{(a+bx)^2} = \frac{x^2}{2b^2} - \frac{2ax}{b^3} + \frac{a^3}{b^4(a+bx)} + \frac{3a^2}{b^4} \ln|a+bx| \quad (\text{see 4.2.2.6.2})$$

$$3. \int \frac{x^3 dx}{(a+bx)^3} = \left(\frac{x^3}{b} + \frac{2ax^2}{b^2} - \frac{2a^2x}{b^3} - \frac{5a^3}{2b^4} \right) \frac{1}{(a+bx)^2} - \frac{3a}{b^4} \ln|a+bx|$$

$$4. \int \frac{x^3 dx}{(a+bx)^n} = \frac{x^3}{b(4-n)(a+bx)^{n-1}} - \frac{3a}{b(4-n)} \int \frac{x^2 dx}{(a+bx)^n}$$

[reduction formula for $n \neq 4$]

4.2.2.5

For arbitrary positive integers m, n the following reduction formula applies:

$$1. \int \frac{x^m dx}{(a+bx)^n} = \frac{-x^m}{b(m+1-n)(a+bx)^{n-1}} - \frac{ma}{b(m+1-n)} \int \frac{x^{m-1} dx}{(a+bx)^n}$$

For $m = n - 1$ the above reduction formula can be replaced with

$$2. \int \frac{x^{n-1} dx}{(a+bx)^n} = \frac{x^{n-1}}{b(n-1)(a+bx)^{n-1}} + \frac{1}{b} \int \frac{x^{n-2} dx}{(a+bx)^{n-1}}$$

4.2.2.6

$$1. \int \frac{x^n dx}{a+bx} = \frac{x^n}{nb} - \frac{ax^{n-1}}{(n-1)b^2} + \frac{a^2x^{n-2}}{(n-2)b^3} - \dots + (-1)^{n-1} \frac{a^{n-1}x}{1 \cdot b^n} + \frac{(-1)^n a^n}{b^{n+1}} \ln|a+bx|$$

$$2. \int \frac{x^n dx}{(a+bx)^2} = \sum_{k=1}^{n-1} (-1)^{k-1} \frac{ka^{k-1}x^{n-k}}{(n-k)b^{k+1}} + (-1)^{n-1} \frac{a^n}{b^{n+1}(a+bx)} + (-1)^{n+1} \frac{na^{n-1}}{b^{n+1}} \ln|a+bx|$$

4.2.2.7

$$1. \int \frac{dx}{x(a+bx)} = -\frac{1}{a} \ln \left| \frac{a+bx}{x} \right|$$

$$2. \int \frac{dx}{x(a+bx)^2} = \frac{1}{a(a+bx)} - \frac{1}{a^2} \ln \left| \frac{a+bx}{x} \right|$$

$$3. \int \frac{dx}{x(a+bx)^3} = \left(\frac{3}{2a} + \frac{bx}{a^2} \right) \frac{1}{(a+bx)^2} - \frac{1}{a^3} \ln \left| \frac{a+bx}{x} \right|$$

$$4. \int \frac{dx}{x(a+bx)^n} = \frac{1}{a(n-1)(a+bx)^{n-1}} + \frac{1}{a} \int \frac{dx}{x(a+bx)^{n-1}} \quad [\text{reduction formula for } n \neq 1]$$

4.2.2.8

$$1. \int \frac{dx}{x^2(a+bx)} = -\frac{1}{ax} + \frac{b}{a^2} \ln \left| \frac{a+bx}{x} \right|$$

$$2. \int \frac{dx}{x^2(a+bx)^2} = -\left(\frac{1}{ax} + \frac{2b}{a^2}\right) \frac{1}{(a+bx)} + \frac{2b}{a^3} \ln \left| \frac{a+bx}{x} \right|$$

$$3. \int \frac{dx}{x^2(a+bx)^3} = -\left(\frac{1}{ax} + \frac{9b}{2a^2} + \frac{3b^2x}{a^3}\right) \frac{1}{(a+bx)^2} + \frac{3b}{a^4} \ln \left| \frac{a+bx}{x} \right|$$

$$4. \int \frac{dx}{x^2(a+bx)^n} = \frac{-1}{ax(a+bx)^{n-1}} - \frac{nb}{a} \int \frac{dx}{x(a+bx)^n} \quad [\text{reduction formula}]$$

4.2.3 Integrands Involving Linear Factors

4.2.3.1

Integrals of the form

$$\int \frac{x^m dx}{(x-a)^n(x-b)^r \cdots (x-q)^s}$$

can be integrated by first expressing the integrand in terms of partial fractions (see 1.7), and then integrating the result term by term.

4.2.3.2

$$1. \int \left(\frac{a+bx}{c+dx} \right) dx = \frac{bx}{d} + \left(\frac{ad-bc}{d^2} \right) \ln|c+dx|$$

$$2. \int \frac{dx}{(x-a)(x-b)} = \frac{1}{(a-b)} \ln \left| \frac{x-a}{x-b} \right| \quad [a \neq b]$$

$$3. \int \frac{x dx}{(x-a)(x-b)} = \frac{a}{(a-b)} \ln|x-a| - \frac{b}{(a-b)} \ln|x-b| \quad [a \neq b]$$

$$4. \int \frac{dx}{(x-a)^2(x-b)} = \frac{-1}{(x-a)(a-b)} - \frac{1}{(a-b)^2} \ln \left| \frac{x-a}{x-b} \right| \quad [a \neq b]$$

$$5. \int \frac{dx}{(x-a)^2(x-b)^2} = \frac{a+b-2x}{(x-a)(x-b)(a-b)^2} - \frac{2}{(a-b)^3} \ln \left| \frac{x-a}{x-b} \right| \quad [a \neq b]$$

6. $\int \frac{x dx}{(x-a)^2(x-b)} = \frac{-a}{(x-a)(a-b)} + \frac{b}{(a-b)^2} \ln \left| \frac{x-b}{x-a} \right| \quad [a \neq b]$
7. $\int \frac{x dx}{(x-a)^2(x-b)^2} = \frac{2ab - (a+b)x}{(x-a)(x-b)(a-b)^2} + \frac{(a+b)}{(a-b)^3} \ln \left| \frac{x-b}{x-a} \right| \quad [a \neq b]$
8. $\int \frac{x^2 dx}{(x-a)^2(x-b)^2} = \frac{ab(a+b) - (a^2+b^2)x}{(x-a)(x-b)(a-b)^2} + \frac{2ab}{(a-b)^3} \ln \left| \frac{x-b}{x-a} \right| \quad [a \neq b]$

4.2.4 Integrands Involving $a^2 \pm b^2x^2$

4.2.4.1

1. $\int \frac{dx}{a^2 + b^2x^2} = \frac{1}{ab} \arctan\left(\frac{bx}{a}\right) \quad \left[-\frac{\pi}{2} < \arctan\left(\frac{bx}{a}\right) < \frac{\pi}{2}\right]$
2. $\int \frac{dx}{(a^2 + b^2x^2)^2} = \frac{x}{2a^2(a^2 + b^2x^2)} + \frac{1}{2a^3b} \arctan\left(\frac{bx}{a}\right) \quad \left[-\frac{\pi}{2} < \arctan\left(\frac{bx}{a}\right) < \frac{\pi}{2}\right]$
3. $\int \frac{dx}{(a^2 + b^2x^2)^3} = \frac{x(5a^2 + 3b^2x^2)}{8a^4(a^2 + b^2x^2)^2} + \frac{3}{8a^5b} \arctan\left(\frac{bx}{a}\right) \quad \left[-\frac{\pi}{2} < \arctan\left(\frac{bx}{a}\right) < \frac{\pi}{2}\right]$
4. $\int \frac{dx}{(a^2 + b^2x^2)^n} = \frac{x}{2(n-1)a^2(a^2 + b^2x^2)^{n-1}} + \frac{(2n-3)}{2(n-1)a^2} \int \frac{dx}{(a^2 + b^2x^2)^{n-1}} \quad [\text{reduction formula } n > 1]$

4.2.4.2

1. $\int \frac{x dx}{a^2 + b^2x^2} = \frac{1}{2b^2} \ln(a^2 + b^2x^2)$
2. $\int \frac{x dx}{(a^2 + b^2x^2)^2} = \frac{-1}{2b^2(a^2 + b^2x^2)}$
3. $\int \frac{x dx}{(a^2 + b^2x^2)^3} = \frac{-1}{4b^2(a^2 + b^2x^2)^2}$
4. $\int \frac{x dx}{(a^2 + b^2x^2)^n} = \frac{-1}{2(n-1)b^2(a^2 + b^2x^2)^{n-1}} \quad [n \neq 1]$

4.2.4.3

1. $\int \frac{x^2 dx}{a^2 + b^2x^2} = \frac{x}{b^2} - \frac{a}{b^3} \arctan\left(\frac{bx}{a}\right) \quad \left[-\frac{\pi}{2} < \arctan\left(\frac{bx}{a}\right) < \frac{\pi}{2}\right]$

$$2. \int \frac{x^2 dx}{(a^2 + b^2x^2)^2} = \frac{-x}{2b^2(a^2 + b^2x^2)} + \frac{1}{2ab^3} \arctan\left(\frac{bx}{a}\right) \quad \left[-\frac{\pi}{2} < \arctan\left(\frac{bx}{a}\right) < \frac{\pi}{2}\right]$$

$$3. \int \frac{x^2 dx}{(a^2 + b^2x^2)^3} = \frac{x(b^2x^2 - a^2)}{8a^2b^2(a^2 + b^2x^2)^2} + \frac{1}{8a^3b^3} \arctan\left(\frac{bx}{a}\right) \quad \left[-\frac{\pi}{2} < \arctan\left(\frac{bx}{a}\right) < \frac{\pi}{2}\right]$$

4.2.4.4

$$1. \int \frac{x^3 dx}{a^2 + b^2x^2} = \frac{x^2}{2b^2} - \frac{a^2}{2b^4} \ln(a^2 + b^2x^2)$$

$$2. \int \frac{x^3 dx}{(a^2 + b^2x^2)^2} = \frac{a^2}{2b^4(a^2 + b^2x^2)} + \frac{1}{2b^4} \ln(a^2 + b^2x^2)$$

$$3. \int \frac{x^3 dx}{(a^2 + b^2x^2)^3} = \frac{-(a^2 + 2b^2x^2)}{4b^3(a^2 + b^2x^2)^2}$$

$$4. \int \frac{x^3 dx}{(a^2 + b^2x^2)^n} = \frac{-[a^2 + (n-1)b^2x^2]}{2(n-1)(n-2)b^4(a^2 + b^2x^2)^{n-1}} \quad [n > 2]$$

4.2.4.5

$$1. \int \frac{dx}{a^2 - b^2x^2} = -\frac{1}{2ab} \ln \left| \frac{bx - a}{bx + a} \right|$$

$$2. \int \frac{dx}{(a^2 - b^2x^2)^2} = \frac{x}{2a^2(a^2 - b^2x^2)} - \frac{1}{4a^3b} \ln \left| \frac{bx - a}{bx + a} \right|$$

$$3. \int \frac{dx}{(a^2 - b^2x^2)^3} = \frac{x(5a^2 - 3b^2x^2)}{8a^4(a^2 - b^2x^2)^2} - \frac{3}{16a^5b} \ln \left| \frac{bx - a}{bx + a} \right|$$

$$4. \int \frac{dx}{(a^2 - b^2x^2)^n} = \frac{x}{2(n-1)a^2(a^2 - b^2x^2)^{n-1}} + \frac{(2n-3)}{2(n-1)a^2} \\ \times \int \frac{dx}{(a^2 - b^2x^2)^{n-1}} \quad [\text{reduction formula for } n > 1]$$

4.2.4.6

$$1. \int \frac{x dx}{(a^2 - b^2x^2)} = -\frac{1}{2b^2} \ln|a^2 - b^2x^2|$$

$$2. \int \frac{x dx}{(a^2 - b^2x^2)^2} = \frac{1}{2b^2(a^2 - b^2x^2)}$$

$$3. \int \frac{x \, dx}{(a^2 - b^2 x^2)^3} = \frac{1}{4b^2 (a^2 - b^2 x^2)^2}$$

$$4. \int \frac{x \, dx}{(a^2 - b^2 x^2)^n} = \frac{1}{2(n-1)b^2 (a^2 - b^2 x^2)^{n-1}}$$

4.2.4.7

$$1. \int \frac{x^2 \, dx}{a^2 - b^2 x^2} = -\frac{x^2}{b^2} - \frac{a}{2b^3} \ln \left| \frac{bx - a}{bx + a} \right|$$

$$2. \int \frac{x^2 \, dx}{(a^2 - b^2 x^2)^2} = \frac{x}{2b^2 (a^2 - b^2 x^2)} + \frac{1}{4ab^3} + \ln \left| \frac{bx - a}{bx + a} \right|$$

$$3. \int \frac{x^2 \, dx}{(a^2 - b^2 x^2)^3} = \frac{x(a^2 + b^2 x^2)}{8a^2 b^2 (a^2 - b^2 x^2)^2} + \frac{1}{16a^3 b^3} \ln \left| \frac{bx - a}{bx + a} \right|$$

4.2.4.8

$$1. \int \frac{x^3 \, dx}{a^2 - b^2 x^2} = -\frac{x^2}{2b^2} - \frac{a^2}{2b^4} \ln |a^2 - b^2 x^2|$$

$$2. \int \frac{x^3 \, dx}{(a^2 - b^2 x^2)^2} = \frac{a^2}{2b^4 (a^2 - b^2 x^2)} + \frac{1}{2b^4} \ln |a^2 - b^2 x^2|$$

$$3. \int \frac{x^3 \, dx}{(a^2 - b^2 x^2)^3} = \frac{2b^2 x^2 - a^2}{4b^4 (a^2 - b^2 x^2)^2}$$

4.2.4.9

$$1. \int \frac{dx}{a^2 + x^2} = \frac{1}{a} \arctan \frac{x}{a}$$

$$2. \int \frac{dx}{x(a^2 + x^2)} = \frac{1}{2a^2} \ln \left(\frac{x^2}{a^2 + x^2} \right)$$

$$3. \int \frac{dx}{x^2(a^2 + x^2)} = -\frac{1}{a^2 x} - \frac{1}{a^3} \arctan \frac{x}{a}$$

$$4. \int \frac{dx}{x^3(a^2 + x^2)} = -\frac{1}{2a^2 x^2} - \frac{1}{2a^4} \ln \left(\frac{x^2}{a^2 + x^2} \right)$$

$$5. \int \frac{dx}{x^4(a^2 + x^2)} = -\frac{1}{3a^2 x^3} + \frac{1}{a^4 x} + \frac{1}{a^5} \arctan \frac{x}{a}$$

$$6. \int \frac{dx}{x(a^2 + x^2)^2} = \frac{1}{2a^2(a^2 + x^2)} + \frac{1}{2a^4} \ln \left(\frac{x^2}{a^2 + x^2} \right)$$

$$7. \int \frac{dx}{x^2(a^2 + x^2)^2} = -\frac{1}{a^4x} - \frac{x}{2a^4(a^2 + x^2)} - \frac{3}{2a^5} \arctan \frac{x}{a}$$

$$8. \int \frac{dx}{(a^2 - x^2)} = \frac{1}{2a} \ln \left| \frac{a+x}{a-x} \right|$$

$$9. \int \frac{dx}{x(a^2 - x^2)} = \frac{1}{2a^2} \ln \left| \frac{x^2}{a^2 - x^2} \right|$$

$$10. \int \frac{dx}{x^2(a^2 - x^2)} = -\frac{1}{a^2x} + \frac{1}{2a^3} \ln \left| \frac{a+x}{a-x} \right|$$

$$11. \int \frac{dx}{x^3(a^2 - x^2)} = -\frac{1}{2a^2x^2} + \frac{1}{2a^4} \ln \left| \frac{x^2}{a^2 - x^2} \right|$$

$$12. \int \frac{dx}{x^4(a^2 - x^2)} = -\frac{1}{3a^2x^3} - \frac{1}{a^4x} + \frac{1}{2a^5} \ln \left| \frac{a+x}{a-x} \right|$$

$$13. \int \frac{dx}{x(a^2 - x^2)^2} = \frac{1}{2a^2(a^2 - x^2)} + \frac{1}{2a^4} \ln \left| \frac{x^2}{a^2 - x^2} \right|$$

$$14. \int \frac{dx}{x^2(a^2 - x^2)^2} = -\frac{1}{a^4x} + \frac{x}{2a^4(a^2 - x^2)} + \frac{3}{4a^3} \ln \left| \frac{a+x}{a-x} \right|$$

4.2.4.10

The change of variable $x^2 = u$ reduces integrals of the form

$$\int \frac{x^{2m+1} dx}{(a^2 \pm b^2x^2)^n}$$

to the simple form

$$\frac{1}{2} \int \frac{u^m du}{(a^2 \pm b^2u)^n},$$

as listed in 4.2.2.

4.2.4.11

The change of variable $x^2 = u$ reduces integrals of the form

$$\int \frac{x^{2m+1} dx}{(a^4 \pm b^4x^4)^n}$$

to the simpler form

$$\frac{1}{2} \int \frac{u^m du}{(a^4 \pm b^4 u^2)^n},$$

as listed in 4.2.4.1–4.2.4.8.

4.2.5 Integrands Involving $a + bx + cx^2$

Notation: $R = a + bx + cx^2$, $\Delta = 4ac - b^2$

4.2.5.1

$$\begin{aligned} 1. \quad \int \frac{dx}{R} &= \frac{1}{\sqrt{-\Delta}} \ln \left| \frac{\sqrt{-\Delta} - (b + 2cx)}{(b + 2cx) + \sqrt{-\Delta}} \right| \\ &= \frac{-2}{\sqrt{-\Delta}} \operatorname{arctanh} \left(\frac{b + 2cx}{\sqrt{-\Delta}} \right) \quad [\Delta < 0] \\ &= \frac{-2}{b + 2cx} \quad [\Delta = 0] \\ &= \frac{2}{\sqrt{\Delta}} \arctan \left(\frac{b + 2cx}{\sqrt{\Delta}} \right) \quad [\Delta > 0] \end{aligned}$$

$$2. \quad \int \frac{dx}{R^2} = \frac{b + 2cx}{\Delta R} + \frac{2c}{\Delta} \int \frac{dx}{R}$$

$$3. \quad \int \frac{dx}{R^3} = \left(\frac{b + 2cx}{\Delta} \right) \left(\frac{1}{2R^2} + \frac{3c}{\Delta R} \right) + \frac{6c^2}{\Delta^2} \int \frac{dx}{R}$$

$$\begin{aligned} 4. \quad \int \frac{dx}{R^{n+1}} &= \frac{b + 2cx}{n\Delta R^n} + \frac{(4n - 2)c}{n\Delta} \int \frac{dx}{R^n} \\ &= \frac{(b + 2cx)}{2n + 1} \sum_{k=0}^{n-1} \frac{2k(2n + 1)(2n - 1)(2n - 3) \cdots (2n - 2k + 1) c^k}{n(n - 1) \cdots (n - k) \Delta^{k+1} R^{n-k}} \\ &\quad + \frac{2^n (2n - 1)!! c^n}{n! \Delta^n} \int \frac{dx}{R} \end{aligned}$$

[general reduction formula: **double factorial** $(2n - 1)!! = 1 \cdot 3 \cdot 5 \cdots (2n - 1)$]

4.2.5.2

$$1. \quad \int \frac{x dx}{R} = \frac{1}{2c} \ln R - \frac{b}{2c} \int \frac{dx}{R}$$

$$2. \int \frac{x \, dx}{R^2} = -\left(\frac{2a + bx}{\Delta R}\right) - \frac{b}{\Delta} \int \frac{dx}{R}$$

$$3. \int \frac{x \, dx}{R^3} = -\left(\frac{2a + bx}{2\Delta R^2}\right) - \frac{3b(b + 2cx)}{2\Delta^2 R} - \frac{3bc}{\Delta^2} \int \frac{dx}{R}$$

$$4. \int \frac{x^2 \, dx}{R^2} = \frac{x}{c} - \frac{b}{2c^2} \ln R + \left(\frac{b^2 - 2ac}{2c^2}\right) \int \frac{dx}{R}$$

$$5. \int \frac{x^2 \, dx}{R^2} = \frac{ab + (b^2 - 2ac)x}{c\Delta R} + \frac{2a}{\Delta} \int \frac{dx}{R}$$

$$6. \int \frac{x^2 \, dx}{R^3} = \frac{ab + (b^2 - 2ac)x}{2c\Delta R^2} + \frac{(2ac + b^2)(b + 2cx)}{2c\Delta^2 R} + \frac{(2ac + b^2)}{\Delta^2} \int \frac{dx}{R}$$

$$7. \int \frac{x^m \, dx}{R^n} = \frac{-x^{m-1}}{(2n - m - 1)cR^{n-1}} - \frac{(n - m)b}{(2n - m - 1)c} \int \frac{x^{m-1} \, dx}{R^n} \\ + \frac{(m - 1)a}{(2n - m - 1)c} \int \frac{x^{m-2} \, dx}{R^n} \quad \text{[general reduction formula: } m \neq 2n - 1]$$

$$8. \int \frac{x^{2n-1} \, dx}{R^n} = \frac{1}{c} \int \frac{x^{2n-3} \, dx}{R^{n-1}} - \frac{a}{c} \int \frac{x^{2n-3} \, dx}{R^n} - \frac{b}{c} \int \frac{x^{2n-2} \, dx}{R^n}$$

[general reduction formula:
case $m = 2n - 1$ in 4.2.5.2.7]

4.2.5.3

$$1. \int \frac{dx}{xR} = \frac{1}{2a} \ln \frac{x^2}{R} - \frac{b}{2a} \int \frac{dx}{R}$$

$$2. \int \frac{dx}{xR^2} = \frac{1}{2a^2} \ln \frac{x^2}{R} + \frac{1}{2aR} \left[1 - \frac{b(b + 2cx)}{\Delta}\right] - \frac{b}{2a^2} \left(1 + \frac{2ac}{\Delta}\right) \int \frac{dx}{R}$$

$$3. \int \frac{dx}{x^2 R} = -\frac{b}{2a^2} \ln \frac{x^2}{R} - \frac{1}{ax} + \frac{(b^2 - 2ac)}{2a^2} \int \frac{dx}{R}$$

$$4. \int \frac{dx}{x^m R^n} = \frac{-1}{(m - 1)ax^{m-1}R^{n-1}} - \frac{b(m + n - 2)}{a(m - 1)} \int \frac{dx}{x^{m-1}R^n} \\ - \frac{c(m + 2n - 3)}{a(m - 1)} \int \frac{dx}{x^{m-2}R^n} \quad \text{[general reduction formula]}$$

4.2.6 Integrands Involving $a + bx^3$

Notation: $\alpha = (a/b)^{1/3}$

4.2.6.1

$$1. \int \frac{dx}{a + bx^3} = \frac{\alpha}{3a} \left\{ \frac{1}{2} \ln \left| \frac{(x + \alpha)^2}{x^2 - \alpha x + \alpha^2} \right| + \sqrt{3} \arctan \left(\frac{x\sqrt{3}}{2\alpha - x} \right) \right\}$$

$$= \frac{\alpha}{3a} \left\{ \frac{1}{2} \ln \left| \frac{(x + \alpha)^2}{x^2 - \alpha x + \alpha^2} \right| + \sqrt{3} \arctan \left(\frac{2x - \alpha}{\alpha\sqrt{3}} \right) \right\}$$

$$2. \int \frac{x dx}{a + bx^3} = -\frac{1}{3b\alpha} \left\{ \frac{1}{2} \ln \left| \frac{(x + \alpha)^2}{x^2 - \alpha x + \alpha^2} \right| - \sqrt{3} \arctan \left(\frac{2x - \alpha}{\alpha\sqrt{3}} \right) \right\}$$

$$3. \int \frac{x^2 dx}{a + bx^3} = \frac{1}{3b} \ln |1 + (x/\alpha)^3| = \frac{1}{3b} \ln |a + bx^3|$$

$$4. \int \frac{x^3 dx}{a + bx^3} = \frac{x}{b} - \frac{a}{b} \int \frac{dx}{a + bx^3}$$

$$5. \int \frac{dx}{(a + bx^3)^2} = \frac{x}{3a(a + bx^3)} + \frac{2}{3a} \int \frac{dx}{a + bx^3}$$

$$6. \int \frac{x dx}{(a + bx^3)^2} = \frac{x^2}{3a(a + bx^3)} + \frac{1}{3a} \int \frac{x dx}{a + bx^3}$$

$$7. \int \frac{x^n dx}{(a + bx^3)^m} = \frac{x^{n-2}}{(n+1-3m)b(a + bx^3)^{m-1}}$$

$$- \frac{a(n-2)}{b(n+1-3m)} \int \frac{x^{n-3} dx}{(a + bx^3)^m}$$

$$= \frac{x^{n+1}}{3a(m-1)(a + bx^3)^{m-1}} - \frac{(n+4-3m)}{3a(m-1)} \int \frac{x^n dx}{(a + bx^3)^{m-1}}$$

[general reduction formula]

$$8. \int \frac{dx}{x^n(a + bx^3)^m} = -\frac{1}{(n-1)ax^{n-1}(a + bx^3)^{m-1}}$$

$$- \frac{b(3m+n-4)}{a(n-1)} \int \frac{dx}{x^{n-3}(a + bx^3)^m}$$

$$= \frac{1}{3a(m-1)x^{n-1}(a + bx^3)^{m-1}} + \frac{(n+3m-4)}{3a(m-1)}$$

$$\times \int \frac{dx}{x^n(a + bx^3)^{m-1}} \quad \text{[general reduction formula]}$$

4.2.7 Integrands Involving $a + bx^4$ Notation: $\alpha = (a/b)^{1/4}$, $\alpha' = (-a/b)^{1/4}$ **4.2.7.1**

$$1. \int \frac{dx}{a + bx^4} = \frac{\alpha}{4a\sqrt{2}} \left\{ \ln \left| \frac{x^2 + \alpha x\sqrt{2} + \alpha^2}{x^2 - \alpha x\sqrt{2} + \alpha^2} \right| + 2 \arctan \left(\frac{\alpha x\sqrt{2}}{\alpha^2 - x^2} \right) \right\} \quad [ab > 0]$$

[see 4.2.7.1.3]

$$= \frac{\alpha'}{4a} \left\{ \ln \left| \frac{x + \alpha'}{x - \alpha'} \right| + 2 \arctan \left(\frac{x}{\alpha'} \right) \right\} \quad [ab < 0]$$

[see 4.2.7.1.4]

$$2. \int \frac{x dx}{a + bx^4} = \frac{1}{2\sqrt{ab}} \arctan \left(x^2 \sqrt{\frac{b}{a}} \right) \quad [ab > 0]$$

[see 4.2.7.1.5]

$$= \frac{1}{4i\sqrt{ab}} \ln \left| \frac{a + x^2 i\sqrt{ab}}{a - x^2 i\sqrt{ab}} \right| \quad [ab < 0]$$

[see 4.2.7.1.6]

$$3. \int \frac{dx}{a^4 + x^4} = \frac{1}{4a^3\sqrt{2}} \ln \left| \frac{x^2 + ax\sqrt{2} + a^2}{x^2 - ax\sqrt{2} + a^2} \right| + \frac{1}{2a^3\sqrt{2}} \arctan \left(\frac{ax\sqrt{2}}{a^2 - x^2} \right)$$

[special case of 4.2.7.1.1]

$$4. \int \frac{dx}{a^4 - x^4} = -\frac{1}{4a^3} \ln \left| \frac{a + x}{a - x} \right| - \frac{1}{2a^3} \arctan \left(\frac{x}{a} \right)$$

[special case of 4.2.7.1.1]

$$5. \int \frac{x dx}{a^4 + x^4} = \frac{1}{2a^2} \arctan \left(\frac{x^2}{a^2} \right)$$

[special case of 4.2.7.1.2]

$$6. \int \frac{x dx}{a^4 - x^4} = \frac{1}{4a^2} \ln \left| \frac{a^2 + x^2}{a^2 - x^2} \right|$$

[special case of 4.2.7.1.2]

$$7. \int \frac{x^2 dx}{a + bx^4} = \frac{1}{4b\alpha\sqrt{2}} \left\{ \ln \left| \frac{x^2 - \alpha x\sqrt{2} + \alpha^2}{x^2 + \alpha x\sqrt{2} + \alpha^2} \right| + 2 \arctan \left(\frac{\alpha x\sqrt{2}}{\alpha^2 - x^2} \right) \right\} \quad [ab > 0]$$

$$= -\frac{1}{4b\alpha'} \left\{ \ln \left| \frac{(x + \alpha')}{x - \alpha'} \right| - 2 \arctan \left(\frac{x}{\alpha'} \right) \right\} \quad [ab < 0]$$

$$8. \int \frac{x^2 dx}{a^4 + x^4} = -\frac{1}{4a\sqrt{2}} \ln \left| \frac{x^2 + ax\sqrt{2} + a^2}{x^2 - ax\sqrt{2} + a^2} \right| + \frac{1}{2a\sqrt{2}} \arctan \left(\frac{ax\sqrt{2}}{a^2 - x^2} \right)$$

[special case of 4.2.7.1.7]

$$9. \int \frac{x^2 dx}{a^4 - x^4} = \frac{1}{4a} \ln \left| \frac{a + x}{a - x} \right| - \frac{1}{2a} \arctan \left(\frac{x}{a} \right)$$

[special case of 4.2.7.1.7]

$$10. \int \frac{dx}{x(a+bx^4)} = \frac{1}{a} \ln|x| - \frac{1}{4a} \ln|a+bx^4|$$

$$11. \int \frac{dx}{x^2(a+bx^4)} = -\frac{1}{ax} - \frac{b}{a} \int \frac{x^2 dx}{a+bx^4}$$

$$12. \int \frac{x^n dx}{(a+bx^4)^m} = \frac{x^{n+1}}{4a(m-1)(a+bx^4)^{m-1}} + \frac{(4m-n-5)}{4a(m-1)} \int \frac{x^n dx}{(a+bx^4)^{m-1}}$$

$$= \frac{x^{n-3}}{(n+1-4m)b(a+bx^4)^{m-1}} - \frac{(n-3)a}{b(n+1-4m)} \int \frac{x^{n-4} dx}{(a+bx^4)^m}$$

[general reduction formula]

$$13. \int \frac{dx}{x^n(a+bx^4)^m} = -\frac{1}{(n-1)ax^{n-1}(a+bx^4)^{m-1}} - \frac{b(4m+n-5)}{(n-1)a} \int \frac{dx}{x^{n-4}(a+bx^4)^m}$$

[general reduction formula: $n \neq 1$]

$$14. \int \frac{dx}{x(a+bx^4)^m} = \frac{1}{a} \int \frac{dx}{x(a+bx^4)^{m-1}} - \frac{b}{a} \int \frac{x^3 dx}{(a+bx^4)^m}$$

[general reduction formula:
case $n = 1$ in 4.2.7.1.12]

4.3 NONRATIONAL ALGEBRAIC FUNCTIONS

4.3.1 Integrands Containing $a + bx^k$ and \sqrt{x}

4.3.1.1

$$1. \int x^{n/2} dx = \frac{2}{n+2} x^{(n+2)/2} \quad [n = 0, 1, \dots]$$

$$2. \int \frac{dx}{x^{n/2}} = -\frac{2}{(n-2)x^{(n-2)/2}} \quad [n = 0, 1, \dots]$$

4.3.1.2

$$1. \int \frac{dx}{x^{1/2}(a+bx)} = \frac{2}{\sqrt{ab}} \arctan\left(\left(\frac{bx}{a}\right)^{1/2}\right) \quad [ab > 0]$$

$$= \frac{1}{i\sqrt{ab}} \ln \left| \frac{a-bx+2i\sqrt{abx}}{a+bx} \right|, \quad [ab < 0]$$

$$2. \int \frac{dx}{x^{1/2}(a+bx)^2} = \frac{x^{1/2}}{a(a+bx)} + \frac{1}{2a} \int \frac{dx}{x^{1/2}(a+bx)}$$

3.
$$\int \frac{dx}{x^{1/2}(a+bx)^3} = x^{1/2} \left\{ \frac{1}{2a(a+bx)^2} + \frac{3}{4a^2(a+bx)} \right\} + \frac{3}{8a^2} \int \frac{dx}{x^{1/2}(a+bx)}$$
4.
$$\int \frac{x^{1/2}dx}{a+bx} = \frac{2x^{1/2}}{b} - \frac{a}{b} \int \frac{dx}{x^{1/2}(a+bx)}$$
5.
$$\int \frac{x^{1/2}dx}{(a+bx)^2} = -\frac{x^{1/2}}{b(a+bx)} + \frac{1}{2b} \int \frac{dx}{x^{1/2}(a+bx)}$$
6.
$$\int \frac{x^{1/2}dx}{(a+bx)^3} = x^{1/2} \left\{ -\frac{1}{2b(a+bx)^2} + \frac{1}{4ab(a+bx)} \right\} + \frac{1}{8ab} \int \frac{dx}{x^{1/2}(a+bx)}$$
7.
$$\int \frac{x^{3/2}dx}{a+bx} = 2x^{1/2} \left\{ \frac{x}{3b} - \frac{a}{b^2} \right\} + \frac{a^2}{b^2} \int \frac{dx}{x^{1/2}(a+bx)}$$
8.
$$\int \frac{x^{(2m+1)/2}dx}{(a+bx)} = 2x^{1/2} \sum_{k=0}^m \frac{(-1)^k a^k x^{m-k}}{(2m-2k+1)b^{k+1}} + (-1)^{m+1} \frac{a^{m+1}}{b^{m+1}} \int \frac{dx}{x^{1/2}(a+bx)}$$
9.
$$\int \frac{x^{3/2}dx}{(a+bx)^2} = \frac{2x^{3/2}}{b(a+bx)} - \frac{3a}{b} \int \frac{x^{1/2}dx}{(a+bx)^2}$$
10.
$$\int \frac{x^{3/2}dx}{(a+bx)^3} = -\frac{2x^{3/2}}{b(a+bx)^2} + \frac{3a}{b} \int \frac{x^{1/2}dx}{(a+bx)^3}$$
11.
$$\int \frac{x^{5/2}dx}{a+bx} = 2x^{1/2} \left(\frac{x^2}{5b} - \frac{ax}{3b^2} + \frac{a^2}{b^3} \right) - \frac{a^3}{b^3} \int \frac{dx}{x^{1/2}(a+bx)}$$
12.
$$\int \frac{x^{5/2}dx}{(a+bx)^2} = \frac{2x^{1/2}}{(a+bx)} \left(\frac{x^2}{3b} - \frac{5ax}{3b^2} \right) + \frac{5a^2}{b^2} \int \frac{x^{1/2}dx}{(a+bx)^2}$$
13.
$$\int \frac{x^{5/2}dx}{(a+bx)^3} = \frac{2x^{1/2}}{(a+bx)^2} \left(\frac{x^2}{b} + \frac{5ax}{b^2} \right) - \frac{15a^2}{b^2} \int \frac{x^{1/2}dx}{(a+bx)^3}$$
14.
$$\int \frac{dx}{x^{1/2}(a+bx)^2} = \frac{x^{1/2}}{a(a+bx)} + \frac{1}{2a} \int \frac{dx}{x^{1/2}(a+bx)}$$
15.
$$\int \frac{dx}{x^{1/2}(a+bx)^3} = x^{1/2} \left\{ \frac{1}{2a(a+bx)^2} + \frac{3}{4a^2(a+bx)} \right\} + \frac{3}{8a^2} \int \frac{dx}{x^{1/2}(a+bx)}$$
16.
$$\int \frac{dx}{x^{3/2}(a+bx)} = -\frac{2}{ax^{1/2}} - \frac{2}{a^{1/2}} \left(\frac{b}{a} \right)^{1/2} \arctan \left[\left(\frac{bx}{a} \right)^{1/2} \right]$$

$$17. \int \frac{dx}{x^{3/2}(a+bx)^2} = -\frac{(2a+3bx)}{a^2x^{1/2}(a+bx)} - \frac{3}{a^2} \left(\frac{b}{a}\right)^{1/2} \arctan\left[\left(\frac{bx}{a}\right)^{1/2}\right]$$

$$18. \int \frac{dx}{x^{3/2}(a+bx)^3} = -\frac{(8a^2+25abx+15b^2x^2)}{4a^3x^{1/2}(a+bx)^2} - \frac{15}{4a^3} \left(\frac{b}{a}\right)^{1/2} \arctan\left[\left(\frac{bx}{a}\right)^{1/2}\right]$$

4.3.1.3

Notation: $\alpha = (a/b)^{1/4}$, $\alpha' = (-a/b)^{1/4}$

$$1. \int \frac{dx}{x^{1/2}(a+bx^2)} = \frac{1}{b\alpha^3\sqrt{2}} \left\{ \ln \left| \frac{x + \alpha\sqrt{2x} + \alpha^2}{(a+bx^2)^{1/2}} \right| + \arctan\left(\frac{\alpha\sqrt{2x}}{\alpha^2-x}\right) \right\} \quad \left[\frac{a}{b} > x^2 > 0\right]$$

$$= \frac{1}{2b\alpha^3} \left\{ \ln \left| \frac{\alpha' - x^{1/2}}{\alpha' + x^{1/2}} \right| - 2 \arctan\left(\frac{x^{1/2}}{\alpha'}\right) \right\} \quad \left[-\frac{a}{b} > x^2 < 0\right]$$

$$2. \int \frac{x^{1/2} dx}{a+bx^2} = \frac{1}{b\alpha\sqrt{2}} \left\{ -\ln \left| \frac{x + \alpha\sqrt{2x} + \alpha^2}{(a+bx^2)^{1/2}} \right| + \arctan\left(\frac{\alpha\sqrt{2x}}{\alpha^2-x}\right) \right\} \quad \left[\frac{a}{b} > x^2 > 0\right]$$

$$= \frac{1}{2b\alpha'} \left\{ \ln \left| \frac{\alpha' - x^{1/2}}{\alpha' + x^{1/2}} \right| + 2 \arctan\left(\frac{x^{1/2}}{\alpha'}\right) \right\} \quad \left[-\frac{a}{b} > x^2 < 0\right]$$

$$3. \int \frac{x^{3/2} dx}{a+bx^2} = \frac{2x^{1/2}}{b} - \frac{a}{b} \int \frac{dx}{x^{1/2}(a+bx^2)}$$

$$4. \int \frac{x^{5/2} dx}{a+bx^2} = \frac{2x^{3/2}}{3b} - \frac{a}{b} \int \frac{x^{1/2} dx}{a+bx^2}$$

$$5. \int \frac{x^{1/2} dx}{(a+bx^2)^2} = \frac{x^{3/2}}{2a(a+bx^2)} + \frac{1}{4a} \int \frac{x^{1/2} dx}{(a+bx^2)}$$

$$6. \int \frac{dx}{x^{1/2}(a+bx^2)^2} = \frac{x^{1/2}}{2a(a+bx^2)} + \frac{3}{4a} \int \frac{dx}{x^{1/2}(a+bx^2)}$$

$$7. \int \frac{dx}{x^{1/2}(a+bx^2)^3} = x^{1/2} \left(\frac{1}{4a(a+bx^2)^2} + \frac{7}{16a^2(a+bx^2)} \right) + \frac{21}{32a^2} \int \frac{dx}{x^{1/2}(a+bx^2)}$$

4.3.2 Integrands Containing $(a+bx)^{1/2}$

4.3.2.1

$$1. \int \frac{dx}{(a+bx)^{1/2}} = \frac{2}{b} (a+bx)^{1/2}$$

2.
$$\int \frac{x dx}{(a+bx)^{1/2}} = \frac{2}{b^2} (a+bx)^{1/2} \left\{ \frac{1}{3} (a+bx) - a \right\}$$
3.
$$\int \frac{x^2 dx}{(a+bx)^{1/2}} = \frac{2}{b^3} (a+bx)^{1/2} \left\{ \frac{1}{5} (a+bx)^2 - \frac{2}{3} a(a+bx) + a^2 \right\}$$
4.
$$\int \frac{dx}{(a+bx)^{3/2}} = -\frac{2}{b(a+bx)^{1/2}}$$
5.
$$\int \frac{x dx}{(a+bx)^{3/2}} = \frac{2(2a+bx)}{b^2(a+bx)^{1/2}}$$
6.
$$\int \frac{x^2 dx}{(a+bx)^{3/2}} = \frac{2}{b^3(a+bx)^{1/2}} \left(\frac{1}{3} (a+bx)^2 - 2a(a+bx) - a^2 \right)$$
7.
$$\int \frac{x^3 dx}{(a+bx)^{3/2}} = \frac{2(b^3x^3 - 2ab^2x^2 + 8a^2bx + 16a^3)}{5b^4(a+bx)^{1/2}}$$
8.
$$\int \frac{dx}{x(a+bx)^{1/2}} = \frac{1}{\sqrt{a}} \ln \left| \frac{(a+bx)^{1/2} - \sqrt{a}}{(a+bx)^{1/2} + \sqrt{a}} \right| \quad [a > 0]$$

$$= \frac{2}{\sqrt{-a}} \arctan \frac{(a+bx)^{1/2}}{\sqrt{-a}} \quad [a < 0]$$
9.
$$\int \frac{dx}{x(a+bx)^{3/2}} = \frac{2}{a(a+bx)^{1/2}} + \frac{1}{a} \int \frac{dx}{x(a+bx)^{1/2}}$$
10.
$$\int \frac{dx}{x(a+bx)^{3/2}} = \frac{2}{a(a+bx)^{1/2}} + \frac{1}{a^2} \int \frac{dx}{x(a+bx)^{1/2}}$$
11.
$$\int \frac{dx}{x^n(a+bx)^{1/2}} = -\frac{(a+bx)^{1/2}}{(n-1)ax^{n-1}} - \frac{(2n-3)}{(2n-2)} \left(\frac{b}{a} \right) \int \frac{dx}{x^{n-1}(a+bx)^{1/2}}$$
12.
$$\int (a+bx)^{1/2} dx = \frac{2}{3b} (a+bx)^{3/2}$$
13.
$$\int (a+bx)^{3/2} dx = \frac{2}{5b} (a+bx)^{5/2}$$
14.
$$\int (a+bx)^{n/2} dx = \frac{2(a+bx)^{(n+2)/2}}{b(n+2)}$$
15.
$$\int x(a+bx)^{1/2} dx = \frac{2}{b^2} \left\{ \frac{1}{5} (a+bx)^{5/2} - \frac{a}{3} (a+bx)^{3/2} \right\}$$

16. $\int x(a+bx)^{3/2} dx = \frac{2}{b^2} \left\{ \frac{1}{7}(a+bx)^{7/2} - \frac{a}{5}(a+bx)^{5/2} \right\}$
17. $\int \frac{(a+bx)^{1/2}}{x} dx = 2(a+bx)^{1/2} + a \int \frac{dx}{x(a+bx)^{1/2}}$
18. $\int \frac{(a+bx)^{3/2}}{x} dx = \frac{2}{3}(a+bx)^{3/2} + 2a(a+bx)^{1/2} + a^2 \int \frac{dx}{x(a+bx)^{1/2}}$
19. $\int \frac{(a+bx)^{1/2}}{x^2} dx = -\frac{(a+bx)^{1/2}}{x} + \frac{b}{2} \int \frac{dx}{x(a+bx)^{1/2}}$
20. $\int \frac{(a+bx)^{1/2}}{x^3} dx = -\frac{(2a+bx)(a+bx)^{1/2}}{4ax^2} - \frac{b^2}{8a} \int \frac{dx}{x(a+bx)^{1/2}}$
21. $\int \frac{(a+bx)^{(2m-1)/2}}{x^n} dx = -\frac{(a+bx)^{(2m+1)/2}}{(n-1)ax^{n-1}} + \frac{(2m-2n+3)}{2(n-1)} \left(\frac{b}{a}\right)$
 $\times \int \frac{(a+bx)^{(2m-1)/2}}{x^{n-1}} dx \quad [n \neq 1]$

4.3.3 Integrands Containing $(a+cx^2)^{1/2}$

$$I_1 = \int \frac{dx}{(a+cx^2)^{1/2}},$$

where

$$I_1 = \frac{1}{\sqrt{c}} \ln \left| x\sqrt{c} + (a+cx^2)^{1/2} \right| \quad [c > 0]$$

$$= \frac{1}{\sqrt{-c}} \arcsin \left(x\sqrt{\frac{-c}{a}} \right) \quad [c < 0, a > 0]$$

$$I_2 = \int \frac{dx}{x(a+cx^2)^{1/2}},$$

where

$$I_2 = \frac{1}{2\sqrt{a}} \ln \left| \frac{(a+cx^2)^{1/2} - \sqrt{a}}{(a+cx^2)^{1/2} + \sqrt{a}} \right| \quad [a > 0, c > 0]$$

$$= \frac{1}{2\sqrt{a}} \ln \left| \frac{\sqrt{a} - (a+cx^2)^{1/2}}{\sqrt{a} + (a+cx^2)^{1/2}} \right| \quad [a > 0, c < 0]$$

$$= \frac{1}{\sqrt{-a}} \operatorname{arcsec} \left(x\sqrt{\frac{-c}{a}} \right) = \frac{1}{\sqrt{-a}} \arccos \left(\frac{1}{x} \sqrt{\frac{-a}{c}} \right) \quad [a < 0, c > 0]$$

4.3.3.1

$$1. \int (a + cx^2)^{3/2} dx = \frac{1}{4}x(a + cx^2)^{3/2} + \frac{3}{8}ax(a + cx^2)^{1/2} + \frac{3}{8}a^2I_1$$

$$2. \int (a + cx^2)^{1/2} dx = \frac{1}{2}x(a + cx^2)^{1/2} + \frac{1}{2}aI_1$$

$$3. \int \frac{dx}{(a + cx^2)^{1/2}} = I_1$$

$$4. \int \frac{dx}{(a + cx^2)^{3/2}} = \frac{1}{a} \frac{x}{(a + cx^2)^{1/2}}$$

$$5. \int \frac{dx}{(a + cx^2)^{(2n+1)/2}} = \frac{1}{a^n} \sum_{k=0}^{n-1} \frac{(-1)^k}{2k+1} \binom{n-1}{k} \frac{c^k x^{2k+1}}{(a + cx^2)^{(2k+1)/2}}$$

$$6. \int \frac{x dx}{(a + cx^2)^{(2n+1)/2}} = -\frac{1}{(2n-1)c(a + cx^2)^{(2n-1)/2}}$$

$$7. \int \frac{x^2 dx}{(a + cx^2)^{(2n+1)/2}} = \frac{1}{a^{n-1}} \sum_{k=0}^{n-2} \frac{(-1)^k}{2k+3} \binom{n-2}{k} \frac{c^k x^{2k+3}}{(a + cx^2)^{(2k+3)/2}}$$

$$8. \int \frac{x^3 dx}{(a + cx^2)^{(2n+1)/2}} = -\frac{1}{(2n-3)c^2(a + cx^2)^{(2n-3)/2}} + \frac{a}{(2n-1)c^2(a + cx^2)^{(2n-1)/2}}$$

$$9. \int x^2(a + cx^2)^{1/2} dx = \frac{1}{4c}x(a + cx^2)^{3/2} - \frac{1}{8c}ax(a + cx^2)^{1/2} - \frac{1}{8} \frac{a^2}{c}I_1$$

$$10. \int \frac{x^2}{(a + cx^2)^{1/2}} dx = \frac{1}{2c}x(a + cx^2)^{1/2} - \frac{1}{2} \frac{a}{c}I_1$$

$$11. \int \frac{x^2}{(a + cx^2)^{3/2}} dx = \frac{-x}{c(a + cx^2)^{1/2}} + \frac{1}{c}I_1$$

$$12. \int \frac{x^2}{(a + cx^2)^{5/2}} dx = \frac{x^3}{3a(a + cx^2)^{3/2}}$$

$$13. \int \frac{(a + cx^2)^{3/2}}{x} dx = \frac{1}{3}(a + cx^2)^{3/2} + a(a + cx^2)^{1/2} + a^2I_2$$

$$14. \int \frac{(a + cx^2)^{1/2}}{x} dx = (a + cx^2)^{1/2} + aI_2$$

$$15. \int \frac{dx}{x(a+cx^2)^{1/2}} = I_2$$

$$16. \int \frac{dx}{x(a+cx^2)^{(2n+1)/2}} = \frac{1}{a^n} I_2 + \sum_{k=0}^{n-1} \frac{1}{(2k+1)a^{n-k}(a+cx^2)^{(2k+1)/2}}$$

$$17. \int \frac{(a+cx^2)^{1/2}}{x^2} dx = -\frac{(a+cx^2)^{1/2}}{x} + cI_1$$

$$18. \int \frac{(a+cx^2)^{3/2}}{x} dx = -\frac{(a+cx^2)^{3/2}}{x} + \frac{3}{2}cx(a+cx^2)^{1/2} + \frac{3}{2}aI_1$$

$$19. \int \frac{(a+cx^2)^{1/2}}{x^3} dx = -\frac{(a+cx^2)^{1/2}}{2x^2} + \frac{c}{2}I_2$$

$$20. \int \frac{(a+cx^2)^{3/2}}{x^3} dx = -\frac{(a+cx^2)^{3/2}}{2x^2} + \frac{3}{2}c(a+cx^2)^{1/2} + \frac{3}{2}acI_2$$

$$21. \int \frac{dx}{x^3(a+cx^2)^{1/2}} = -\frac{(a+cx^2)^{1/2}}{2ax^2} - \frac{c}{2a}I_2$$

$$22. \int \frac{dx}{x^3(a+cx^2)^{3/2}} = -\frac{1}{2ax^2(a+cx^2)^{1/2}} - \frac{3c}{2a^2(a+cx^2)^{1/2}} - \frac{3c}{2a^2}I_2$$

4.3.4 Integrands Containing $(a+bx+cx^2)^{1/2}$

Notation: $R = a+bx+cx^2$, $\Delta = 4ac - b^2$

4.3.4.1

1.
$$\int \frac{dx}{R^{1/2}} = \frac{1}{\sqrt{c}} \ln|2(cR)^{1/2} + 2cx + b| \quad [c > 0]$$

$$= \frac{1}{\sqrt{c}} \operatorname{arcsinh}\left(\frac{2cx+b}{\Delta^{1/2}}\right) \quad [c > 0, \Delta > 0]$$

$$= \frac{-1}{\sqrt{-c}} \arcsin\left(\frac{2cx+b}{(-\Delta)^{1/2}}\right) \quad [c < 0, \Delta < 0]$$

$$= \frac{1}{\sqrt{c}} \ln|2cx+b| \quad [c > 0, \Delta = 0]$$
2.
$$\int \frac{x dx}{R^{1/2}} = \frac{R^{1/2}}{c} - \frac{b}{2c} \int \frac{dx}{R^{1/2}}$$

3.
$$\int \frac{x^2 dx}{R^{1/2}} = \left(\frac{x}{2c} - \frac{3b}{4c^2} \right) R^{1/2} + \left(\frac{3b^2}{8c^2} - \frac{a}{2c} \right) \int \frac{dx}{R^{1/2}}$$
4.
$$\int \frac{x^3 dx}{R^{1/2}} = \left(\frac{x^2}{3c} - \frac{5bx}{12c^2} + \frac{5b^2}{8c^3} - \frac{2a}{3c^2} \right) R^{1/2} - \left(\frac{5b^3}{16c^3} - \frac{3ab}{4c^2} \right) \int \frac{dx}{R^{1/2}}$$
5.
$$\int R^{1/2} dx = \frac{(2cx + b)}{4c} R^{1/2} + \frac{\Delta}{8c} \int \frac{dx}{R^{1/2}}$$
6.
$$\int x R^{1/2} dx = \frac{R^{3/2}}{3c} - \frac{(2cx + b)b}{8c^2} R^{1/2} - \frac{b\Delta}{16c^2} \int \frac{dx}{R^{1/2}}$$
7.
$$\begin{aligned} \int x^2 R^{1/2} dx &= \left(\frac{x}{4c} - \frac{5b}{24c^2} \right) R^{3/2} + \left(\frac{5b^2}{16c^2} - \frac{a}{4c} \right) \frac{(2cx + b) R^{1/2}}{4c} \\ &\quad + \left(\frac{5b^2}{16c^2} - \frac{a}{4c} \right) \frac{\Delta}{8c} \int \frac{dx}{R^{1/2}} \end{aligned}$$
8.
$$\int R^{3/2} dx = \left(\frac{R}{8c} + \frac{3\Delta}{64c^2} \right) (2cx + b) R^{1/2} + \frac{3\Delta^2}{128c^2} \int \frac{dx}{R^{1/2}}$$
9.
$$\int x R^{3/2} dx = \frac{R^{5/2}}{5c} - (2cx + b) \left(\frac{b}{16c^2} R^{3/2} + \frac{3\Delta b}{128c^3} R^{1/2} \right) - \frac{3\Delta^2 b}{256c^3} \int \frac{dx}{R^{1/2}}$$
10.
$$\begin{aligned} \int \frac{dx}{x R^{1/2}} &= -\frac{1}{\sqrt{a}} \ln \left| \frac{2a + bx + 2(aR)^{1/2}}{x} \right| \quad [a > 0] \\ &= \frac{1}{\sqrt{-a}} \arcsin \left(\frac{2a + bx}{x(b^2 - 4ac)^{1/2}} \right) \quad [a < 0, \Delta < 0] \\ &= \frac{1}{\sqrt{-a}} \arctan \left(\frac{2a + bx}{2\sqrt{-a}R^{1/2}} \right) \quad [a < 0] \\ &= -\frac{1}{\sqrt{-a}} \operatorname{arcsinh} \left(\frac{2a + bx}{x\Delta^{1/2}} \right) \quad [a < 0, \Delta > 0] \\ &= -\frac{1}{\sqrt{a}} \operatorname{arctanh} \left(\frac{2a + bx}{2\sqrt{a}R^{1/2}} \right) \quad [a > 0] \\ &= \frac{1}{\sqrt{a}} \ln \left| \frac{x}{2a + bx} \right| \quad [a > 0, \Delta = 0] \\ &= -\frac{2(bx + cx^2)^{1/2}}{bx} \quad [a = 0, b \neq 0] \end{aligned}$$

$$11. \int \frac{dx}{xR^{(2n+1)/2}} = \frac{1}{(2n-1)aR^{(2n-1)/2}} - \frac{b}{2a} \int \frac{dx}{R^{(2n+1)/2}} + \frac{1}{a} \int \frac{dx}{xR^{(2n-1)/2}}$$

$$12. \int \frac{dx}{x^m R^{(2n+1)/2}} = -\frac{1}{(m-1)ax^{m-1}R^{(2n-1)/2}} - \frac{(2n+2m-3)b}{2(m-1)a} \\ \times \int \frac{dx}{x^{m-1}R^{(2n+1)/2}} - \frac{(2n+m-2)c}{(m-1)a} \int \frac{dx}{x^{m-2}R^{(2n+1)/2}}$$

$$13. \int \frac{dx}{x^2 R^{1/2}} = -\frac{R^{1/2}}{ax} - \frac{b}{2a} \int \frac{dx}{xR^{1/2}}$$

$$14. \int \frac{dx}{x^2 (bx + cx^2)^{1/2}} = \frac{2}{3} \left(-\frac{1}{bx^2} + \frac{2c}{b^2x} \right) (bx + cx^2)^{1/2}$$

$$15. \int \frac{dx}{x^3 R^{1/2}} = \left(-\frac{1}{2ax^2} + \frac{3b}{4a^2x} \right) R^{1/2} + \left(\frac{3b^2}{8a^2} - \frac{c}{2a} \right) \int \frac{dx}{xR^{1/2}}$$

$$16. \int \frac{dx}{x^3 (bx + cx^2)^{1/2}} = \frac{2}{5} \left(-\frac{1}{bx^3} + \frac{4c}{3b^2x^2} - \frac{8c^2}{3b^3x} \right) (bx + cx^2)^{1/2}$$

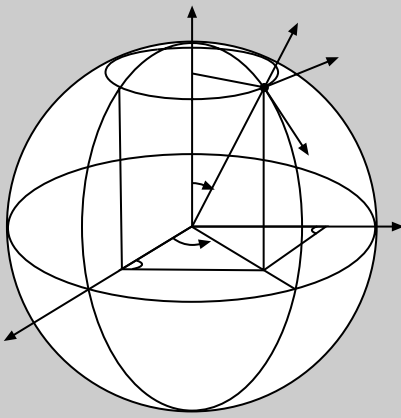

Chapter 5

Indefinite Integrals of Exponential Functions

5.1 BASIC RESULTS

5.1.1 Indefinite Integrals Involving e^{ax}

5.1.1.1

$$\begin{aligned} 1. \quad \int e^x dx &= e^x & 2. \quad \int e^{-x} dx &= -e^{-x} \\ 3. \quad \int e^{ax} dx &= \frac{1}{a}e^{ax} & 4. \quad \int a^x dx &= \int e^{x \ln a} dx = \frac{a^x}{\ln a} \end{aligned}$$

5.1.1.2

As in 5.1.1.1.4, when e^{ax} occurs in an integrand it should be replaced by $a^x = e^{x \ln a}$ (see 2.2.1).

5.1.2 Integrals Involving the Exponential Functions Combined with Rational Functions of x

5.1.2.1 Positive Powers of x

$$\begin{aligned} 1. \quad \int x e^{ax} dx &= e^{ax} \left(\frac{x}{a} - \frac{1}{a^2} \right) \\ 2. \quad \int x^2 e^{ax} dx &= e^{ax} \left(\frac{x^2}{a} - \frac{2x}{a^2} + \frac{2}{a^3} \right) \end{aligned}$$

3. $\int x^3 e^{ax} dx = e^{ax} \left(\frac{x^3}{a} - \frac{3x^2}{a^2} + \frac{6x}{a^3} - \frac{6}{a^4} \right)$
4. $\int x^4 e^{ax} dx = e^{ax} \left(\frac{x^4}{a} - \frac{4x^3}{a^2} + \frac{12x^2}{a^3} - \frac{24x}{a^4} + \frac{24}{a^5} \right)$
5. $\int x^m e^{ax} dx = \frac{x^m e^{ax}}{a} - \frac{m}{a} \int x^{m-1} e^{ax} dx$
6. $\int P_m(x) e^{ax} dx = \frac{e^{ax}}{a} \sum_{k=0}^m (-1)^k \frac{P^{(k)}(x)}{a^k},$

where $P_m(x)$ is a polynomial in x of degree m and $P^{(k)}(x)$ is the k 'th derivative of $P_m(x)$ with respect to x .

5.1.2.2

The **exponential integral** function $Ei(x)$, defined by

1. $Ei(x) = \int \frac{e^x}{x} dx,$

is a transcendental function with the series representation

2. $Ei(x) = \ln|x| + \frac{x}{1!} + \frac{x^2}{2 \cdot 2!} + \frac{x^3}{3 \cdot 3!} + \cdots + \frac{x^k}{k \cdot k!} + \cdots \quad [x^2 < \infty].$

When $Ei(x)$ is tabulated, 5.1.2.2.1, with x replaced by the dummy variable t , is integrated over $-\infty < t \leq x$. The principal value of the integral is used and to the series 5.1.2.2.2 must then be added the Euler constant γ .

5.1.2.3 Negative Powers of x

1. $\int \frac{e^{ax}}{x} dx = Ei(ax)$
2. $\int \frac{e^{ax}}{x^2} dx = -\frac{e^{ax}}{x} + aEi(ax)$
3. $\int \frac{e^{ax}}{x^3} dx = -\frac{e^{ax}}{2x^2} - \frac{ae^{ax}}{2x} + \frac{a^2}{2} Ei(ax)$
4. $\int \frac{e^{ax}}{x^n} dx = -\frac{e^{ax}}{(n-1)x^{n-1}} - \frac{ae^{ax}}{(n-1)(n-2)x^{n-2}} - \cdots - \frac{a^{n-2}e^{ax}}{(n-1)!x} + \frac{a^{n-1}}{(n-1)!} Ei(ax)$

5.1.2.4 Integrands Involving $(a + be^{mx})^{-1}$

1. $\int \frac{dx}{1 + e^x} = \ln\left(\frac{e^x}{1 + e^x}\right) = x - \ln(1 + e^x)$
2. $\int \frac{dx}{a + be^{mx}} = \frac{1}{am} [mx - \ln(a + be^{mx})]$
3. $\int \frac{e^{mx}}{a + be^{mx}} dx = \frac{1}{mb} \ln(a + be^{mx})$
4. $\int \frac{e^{2mx}}{a + be^{mx}} dx = \frac{1}{mb} e^{mx} - \frac{a}{mb^2} \ln(a + be^{mx})$
5. $\int \frac{e^{3mx}}{a + be^{mx}} dx = \frac{1}{2mb} e^{2mx} - \frac{a}{mb^2} e^{mx} + \frac{a^2}{mb^3} \ln(a + be^{mx})$

5.1.2.5 Integrands Involving $xe^{ax}(1 + ax)^{-m}$

1. $\int \frac{xe^x dx}{(1 + x)^2} = \frac{e^x}{1 + x}$
2. $\int \frac{xe^{ax} dx}{(1 + ax)^2} = \frac{e^{ax}}{a^2(1 + ax)}$

5.1.3 Integrands Involving the Exponential Functions Combined with Trigonometric Functions

5.1.3.1

1. $\int e^{ax} \sin bx dx = \frac{e^{ax}}{a^2 + b^2} (a \sin bx - b \cos bx)$
2. $\int e^{ax} \sin^2 bx dx = \frac{e^{ax}}{a(a^2 + 4b^2)} (a^2 \sin^2 bx - 2ab \sin bx \cos bx + 2b^2)$
3. $\int e^{ax} \sin^3 bx dx = \frac{e^{ax}}{(a^2 + b^2)(a^2 + 9b^2)} \times \{a \sin bx [(a^2 + b^2) \sin^2 bx + 6b^2] - 3b \cos bx [(a^2 + b^2) \sin^2 bx + 2b^2]\}$
4. $\int e^{ax} \cos bx dx = \frac{e^{ax}}{a^2 + b^2} (a \cos bx + b \sin bx)$
5. $\int e^{ax} \cos^2 bx dx = \frac{e^{ax}}{a(a^2 + 4b^2)} (a^2 \cos^2 bx + 2ab \sin bx \cos bx + 2b^2)$

$$\begin{aligned}
 6. \quad \int e^{ax} \cos^3 bx \, dx &= \frac{e^{ax}}{(a^2 + b^2)(a^2 + 9b^2)} \\
 &\quad \times [a(a^2 + b^2) \cos^3 bx + 3b(a^2 + b^2) \sin bx \cos^2 bx \\
 &\quad + 6ab^2 \cos bx + 6b^3 \sin bx]
 \end{aligned}$$

$$\begin{aligned}
 7. \quad \int e^{ax} \sin^n bx \, dx &= \frac{1}{a^2 + n^2 b^2} \left[(a \sin bx - nb \cos bx) e^{ax} \sin^{n-1} bx \right. \\
 &\quad \left. + n(n-1)b^2 \int e^{ax} \sin^{n-2} bx \, dx \right]
 \end{aligned}$$

$$\begin{aligned}
 8. \quad \int e^{ax} \cos^n bx \, dx &= \frac{1}{a^2 + n^2 b^2} \left[(a \cos bx + nb \sin bx) e^{ax} \cos^{n-1} bx \right. \\
 &\quad \left. + n(n-1)b \int e^{ax} \cos^{n-2} bx \, dx \right]
 \end{aligned}$$

As an alternative to using the recurrence relations 5.1.3.1.7 and 8, integrals of this type may be evaluated entirely in terms of exponential functions by substituting either $\cos bx = (e^{ibx} + e^{-ibx})/2$, or $\sin bx = (e^{ibx} - e^{-ibx})/(2i)$.

For example,

$$\begin{aligned}
 \int e^{ax} \cos^2 bx \, dx &= \int e^{ax} [(e^{ibx} + e^{-ibx})/2]^2 \, dx \\
 &= \frac{1}{4} \int [e^{(a+i2b)x} + 2e^{ax} + e^{(a-i2b)x}] \, dx \\
 &= \frac{e^{ax}}{2a} + \frac{e^{ax}}{4} \left[\frac{e^{i2bx}}{(a+i2b)} + \frac{e^{-i2bx}}{(a-i2b)} \right] \\
 &= \frac{1}{2a} e^{ax} + \frac{e^{ax}}{2(a^2 + 4b^2)} [a \cos 2bx + 2b \sin 2bx],
 \end{aligned}$$

where the arbitrary additive constant of integration has been omitted.

Notice that this method of integration produces a different form of result compared to the one given in 5.1.3.1.5. That the two results are identical can be seen by substituting $\cos 2bx = 2 \cos^2 bx - 1$, $\sin 2bx = 2 \sin bx \cos bx$ and then combining the terms.

We remark that 5.1.3.1.2 can be deduced directly from 5.1.3.1.5 and, conversely, by using the fact that

$$\int e^{ax} [\cos^2 bx + \sin^2 bx] \, dx = \int e^{ax} \, dx = \frac{1}{a} e^{ax},$$

so

$$\int e^{ax} \sin^2 bx \, dx = \frac{1}{a} e^{ax} - \int e^{ax} \cos^2 bx \, dx,$$

where again the arbitrary additive constant of integration has been omitted.

To evaluate integrals of the form $\int e^{ax} \sin (bx \pm c) dx$ and $\int e^{ax} \cos (bx \pm c) dx$, use the identities

$$\begin{aligned}\sin (bx \pm c) &= \cos c \sin bx \pm \sin c \cos bx \\ \cos (bx \pm c) &= \cos c \cos bx \mp \sin c \sin bx,\end{aligned}$$

to simplify the integrands and then use 5.1.3.1.1 and 4.

To evaluate integrals of the form $\int e^{ax} \sin bx \sin cx \, dx$, $\int e^{ax} \sin bx \cos cx \, dx$, and $\int e^{ax} \cos bx \cos cx \, dx$, use the identities

$$\begin{aligned}\sin bx \sin cx &= \frac{1}{2} [\cos (b - c) x - \cos (b + c) x], \\ \sin bx \cos cx &= \frac{1}{2} [\sin (b + c) x + \sin (b - c) x], \\ \cos bx \cos cx &= \frac{1}{2} [\cos (b + c) x + \cos (b - c) x],\end{aligned}$$

to simplify the integrands and then use 5.1.3.1.1 and 4.

9. $\int x e^{ax} \sin bx \, dx = \frac{e^{ax}}{a^2 + b^2} \left[\left(ax - \frac{a^2 - b^2}{a^2 + b^2} \right) \sin bx - \left(bx - \frac{2ab}{a^2 + b^2} \right) \cos bx \right]$
10. $\int x e^{ax} \cos bx \, dx = \frac{e^{ax}}{a^2 + b^2} \left[\left(ax - \frac{a^2 - b^2}{a^2 + b^2} \right) \cos bx + \left(bx - \frac{2ab}{a^2 + b^2} \right) \sin bx \right]$
11. $\int x^n e^{ax} \sin bx \, dx = e^{ax} \sum_{k=1}^{n+1} \frac{(-1)^{k+1} n! x^{n-k+1}}{(n-k+1)! (a^2 + b^2)^{k/2}} \sin (bx + kt)$
12. $\int x^n e^{ax} \cos bx \, dx = e^{ax} \sum_{k=1}^{n+1} \frac{(-1)^{k+1} n! x^{n-k+1}}{(n-k+1)! (a^2 + b^2)^{k/2}} \cos (bx + kt)$

where

$$\sin t = \frac{-b}{(a^2 + b^2)^{1/2}} \quad \text{and} \quad \cos t = \frac{a}{(a^2 + b^2)^{1/2}}.$$

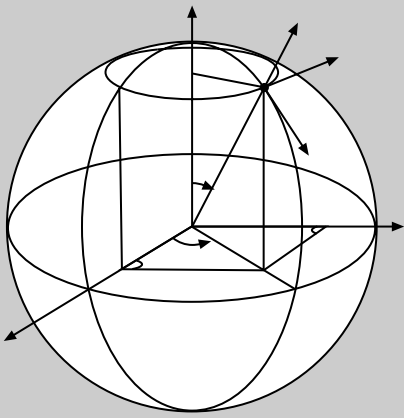

Chapter 6

Indefinite Integrals of Logarithmic Functions

6.1 COMBINATIONS OF LOGARITHMS AND POLYNOMIALS

6.1.1 The Logarithm

6.1.1.1 Integrals Involving $\ln^m(ax)$

$$1. \int \ln x \, dx = x \ln x - x$$

$$2. \int \ln(ax) \, dx = x \ln(ax) - x$$

$$3. \int \ln^2(ax) \, dx = x \ln^2(ax) - 2x \ln(ax) + 2x$$

$$4. \int \ln^3(ax) \, dx = x \ln^3(ax) - 3x \ln^2(ax) + 6x \ln(ax) - 6x$$

$$5. \int \ln^4(ax) \, dx = x \ln^4(ax) - 4x \ln^3(ax) + 12x \ln^2(ax) - 24x \ln(ax) + 24x$$

$$6. \int \ln^m(ax) \, dx = x \ln^m(ax) - m \int \ln^{m-1}(ax) \, dx$$

$$= \frac{x}{m+1} \sum_{k=0}^m (-1)^k (m+1) m(m-1) \cdots (m-k+1) \ln^{m-k}(ax) \quad [m > 0]$$

6.1.2 Integrands Involving Combinations of $\ln(ax)$ and Powers of x

6.1.2.1 Integrands Involving $x^m \ln^n(ax)$

$$1. \int x \ln(ax) dx = \frac{x^2}{2} \ln(ax) - \frac{x^2}{4}$$

$$2. \int x^2 \ln(ax) dx = \frac{x^3}{3} \ln(ax) - \frac{x^3}{9}$$

$$3. \int x^3 \ln(ax) dx = \frac{x^4}{4} \ln(ax) - \frac{x^4}{16}$$

$$4. \int x^n \ln(ax) dx = x^{n+1} \left[\frac{\ln(ax)}{n+1} - \frac{1}{(n+1)^2} \right] \quad [n > 0]$$

$$5. \int x^n \ln^2(ax) dx = x^{n+1} \left[\frac{\ln^2(ax)}{n+1} - \frac{2 \ln(ax)}{(n+1)^2} + \frac{2}{(n+1)^3} \right]$$

$$6. \int x^n \ln^3(ax) dx = x^{n+1} \left[\frac{\ln^3(ax)}{n+1} - \frac{3 \ln^2(ax)}{(n+1)^2} + \frac{6 \ln(ax)}{(n+1)^3} - \frac{6}{(n+1)^4} \right]$$

$$7. \int x^n \ln^m(ax) dx = \frac{x^{n+1}}{m+1} \sum_{k=0}^m (-1)^k \frac{(m+1)m(m-1)\cdots(m-k+1) \ln^{m-k}(ax)}{(n+1)^{k+1}} \quad [n > 0, m > 0]$$

6.1.2.2 Integrands Involving $\ln^m(ax)/x^n$

$$1. \int \frac{\ln(ax)}{x} dx = \frac{1}{2} \{\ln(ax)\}^2$$

$$2. \int \frac{\ln(ax)}{x^2} dx = -\frac{1}{x} [\ln(ax) + 1]$$

$$3. \int \frac{\ln(ax)}{x^3} dx = -\frac{1}{2x^2} \left[\ln(ax) + \frac{1}{2} \right]$$

$$4. \int \frac{\ln^2(ax)}{x} dx = \frac{\ln(a^3 x^3)}{3}$$

$$5. \int \frac{\ln^2(ax)}{x^2} dx = -\frac{1}{x} [\ln(a^2 x^2) + 2 \ln(ax) + 2]$$

6. $\int \frac{\ln^2(ax)}{x^3} dx = -\frac{1}{2x^2} \left[\ln^2(ax) + \ln(ax) + \frac{1}{2} \right]$
7. $\int \frac{\ln^n(ax)}{x^m} dx = \frac{-1}{(n+1)x^{m-1}} \sum_{k=0}^n \frac{(n+1)n(n-1)\cdots(n-k+1)\ln^{n-k}(ax)}{(m-1)^{k+1}} \quad [m > 1]$
8. $\int \frac{\ln^n(ax)}{x} dx = \frac{\ln^{n+1}(ax)}{n+1}$

6.1.2.3 Integrands Involving $[x \ln^m(ax)]^{-1}$

1. $\int \frac{dx}{x \ln(ax)} = \ln|\ln(ax)|$
2. $\int \frac{dx}{x \ln^m(ax)} = \frac{-1}{(m-1)\ln^{m-1}(ax)} \quad [m > 1]$

6.1.3 Integrands Involving $(a + bx)^m \ln^n x$

6.1.3.1 Integrands Involving $(a + bx)^m \ln x$

1. $\int (a + bx) \ln x dx = \left[\frac{(a + bx)^2}{2b} - \frac{a^2}{2b} \right] \ln x - \left(ax + \frac{1}{4}bx^2 \right)$
2. $\int (a + bx)^2 \ln x dx = \frac{1}{3b} \left[(a + bx)^3 - a^3 \right] \ln x - \left(a^2x + \frac{abx^2}{2} + \frac{b^2x^3}{9} \right)$
3. $\int (a + bx)^3 \ln x dx = \frac{1}{4b} \left[(a + bx)^4 - a^4 \right] \ln x - \left(a^3x + \frac{3}{4}a^2bx^2 + \frac{1}{3}ab^2x^3 + \frac{1}{16}b^3x^4 \right)$
4. $\int (a + bx)^m \ln x dx = \frac{1}{(m+1)b} \left[(a + bx)^{m+1} - a^{m+1} \right] \ln x - \sum_{k=0}^m \frac{\binom{m}{k} a^{m-k} b^k x^{k+1}}{(k+1)^2}$

To integrate expressions of the form $(a + bx)^m \ln(cx)$, use the fact that

$$(a + bx)^m \ln(cx) = (a + bx)^m \ln c + (a + bx)^m \ln x$$

to reexpress the integral in terms of 6.1.3.1.1–4.

6.1.3.2 Integrands Involving $\ln x/(a + bx)^m$

1.
$$\int \frac{\ln x \, dx}{(a + bx)^2} = \frac{-\ln x}{b(a + bx)} + \frac{1}{ab} \ln\left(\frac{x}{a + bx}\right)$$
2.
$$\int \frac{\ln x \, dx}{(a + bx)^3} = \frac{-\ln x}{2b(a + bx)^2} + \frac{1}{2ab(a + bx)} + \frac{1}{2a^2b} \ln\left(\frac{x}{a + bx}\right)$$
3.
$$\int \frac{\ln x \, dx}{(a + bx)^m} = \frac{1}{b(m-1)} \left[-\frac{\ln x}{(a + bx)^{m-1}} + \int \frac{dx}{x(a + bx)^{m-1}} \right] \quad [m > 1]$$
4.
$$\int \frac{\ln x \, dx}{(a + bx)^{1/2}} = \frac{2}{b} \left\{ (\ln x - 2)(a + bx)^{1/2} - 2a^{1/2} \ln \left[\frac{(a + bx)^{1/2} - a^{1/2}}{x^{1/2}} \right] \right\} \quad [a > 0]$$

$$= \frac{2}{b} \left\{ (\ln x - 2)(a + bx)^{1/2} - 2(-a)^{1/2} \arctan \left[\left(\frac{a + bx}{-a} \right)^{1/2} \right] \right\} \quad [a < 0]$$

To integrate expressions of the form $\ln(cx)/(a + bx)^m$, use the fact that

$$\ln(cx)/(a + bx)^m = \ln c/(a + bx)^m + \ln x/(a + bx)^m$$

to reexpress the integral in terms of 6.1.3.2.1–4.

6.1.3.3 Integrands Involving $x^m \ln(a + bx)$

1.
$$\int \ln(a + bx) \, dx = \frac{1}{b} (a + bx) \ln(a + bx) - x$$
2.
$$\int x \ln(a + bx) \, dx = \frac{1}{2} \left(x^2 - \frac{a^2}{b^2} \right) \ln(a + bx) - \frac{1}{2} \left(\frac{x^2}{2} - \frac{ax}{b} \right)$$
3.
$$\int x^2 \ln(a + bx) \, dx = \frac{1}{3} \left(x^3 + \frac{a^3}{b^3} \right) \ln(a + bx) - \frac{1}{3} \left(\frac{x^3}{3} - \frac{ax^2}{2b} + \frac{a^2x}{b^2} \right)$$
4.
$$\int x^3 \ln(a + bx) \, dx = \frac{1}{4} \left(x^4 - \frac{a^4}{b^4} \right) \ln(a + bx) - \frac{1}{4} \left(\frac{x^4}{4} - \frac{ax^3}{3b} + \frac{a^2x^2}{2b^2} - \frac{a^3x}{b^3} \right)$$
5.
$$\int x^m \ln(a + bx) \, dx = \frac{1}{m+1} \left[x^{m+1} - \frac{(-a)^{m+1}}{b^{m+1}} \right] \ln(a + bx)$$

$$+ \frac{1}{m+1} \sum_{k=1}^{m+1} \frac{(-1)^k x^{m-k+2} a^{k-1}}{(m-k+2) b^{k-1}}$$

6.1.3.4 Integrands Involving $\ln(a + bx)/x^m$

1.
$$\int \frac{\ln(a + bx)}{x} dx = \ln|a| \ln|x| + \sum_{k=1}^{\infty} \frac{(-1)^{k+1}}{k^2} \left(\frac{bx}{a}\right)^k \quad [|bx| < |a|]$$

$$= \frac{1}{2} \ln^2 |bx| + \sum_{k=1}^{\infty} \frac{(-1)^k}{k^2} \left(\frac{a}{bx}\right)^2 \quad [|bx| > |a|]$$
2.
$$\int \frac{\ln(a + bx)}{x^2} dx = \frac{b}{a} \ln x - \left(\frac{1}{x} + \frac{b}{a}\right) \ln(a + bx)$$
3.
$$\int \frac{\ln(a + bx)}{x^3} dx = \frac{b^2}{2a^2} \ln x + \frac{1}{2} \left(\frac{b^2}{a^2} - \frac{1}{x^2}\right) \ln(a + bx) - \frac{b}{2ax}$$

6.1.4 Integrands Involving $\ln(x^2 \pm a^2)$ **6.1.4.1**

1.
$$\int \ln(x^2 + a^2) dx = x \ln(x^2 + a^2) - 2x + 2a \arctan \frac{x}{a}$$
2.
$$\int x \ln(x^2 + a^2) dx = \frac{1}{2} [(x^2 + a^2) \ln(x^2 + a^2) - x^2]$$
3.
$$\int x^2 \ln(x^2 + a^2) dx = \frac{1}{3} \left[x^3 \ln(x^2 + a^2) - \frac{2}{3} x^3 + 2a^2 x - 2a^3 \arctan \frac{x}{a} \right]$$
4.
$$\int x^3 \ln(x^2 + a^2) dx = \frac{1}{4} \left[(x^4 - a^4) \ln(x^2 + a^2) - \frac{x^4}{2} + a^2 x^2 \right]$$
5.
$$\int x^{2n} \ln(x^2 + a^2) dx = \frac{1}{2n+1} \left\{ x^{2n+1} \ln(x^2 + a^2) + (-1)^n 2a^{2n+1} \arctan \frac{x}{a} \right. \\ \left. - 2 \sum_{k=0}^n \frac{(-1)^{n-k}}{2k+1} a^{2n-2k} x^{2k+1} \right\}$$
6.
$$\int x^{2n+1} \ln(x^2 + a^2) dx = \frac{1}{2n+2} \left\{ (x^{2n+2} + (-1)^n a^{2n+2}) \ln(x^2 + a^2) \right. \\ \left. + \sum_{k=1}^{n+1} \frac{(-1)^{n-k}}{k} a^{2n-2k+2} x^{2k} \right\}$$
7.
$$\int \ln|x^2 - a^2| dx = x \ln|x^2 - a^2| - 2x + a \ln \left| \frac{x+a}{x-a} \right|$$

8. $\int x \ln |x^2 - a^2| dx = \frac{1}{2} \{ (x^2 - a^2) \ln |x^2 - a^2| - x^2 \}$
9. $\int x^2 \ln |x^2 - a^2| dx = \frac{1}{3} \left\{ x^3 \ln |x^2 - a^2| - \frac{2}{3} x^3 - 2a^2 x + a^3 \ln \left| \frac{x+a}{x-a} \right| \right\}$
10. $\int x^3 \ln |x^2 - a^2| dx = \frac{1}{4} \left\{ (x^4 - a^4) \ln |x^2 - a^2| - \frac{x^4}{2} - a^2 x^2 \right\}$
11. $\int x^{2n} \ln |x^2 - a^2| dx = \frac{1}{2n+1} \left\{ x^{2n+1} \ln |x^2 - a^2| + a^{2n+1} \ln \left| \frac{x+a}{x-a} \right| - 2 \sum_{k=0}^n \frac{1}{2k+1} a^{2n-2k} x^{2k+1} \right\}$
12. $\int x^{2n+1} \ln |x^2 - a^2| dx = \frac{1}{2n+2} \left\{ (x^{2n+2} - a^{2n+2}) \ln |x^2 - a^2| - \sum_{k=1}^{n+1} \frac{1}{k} a^{2n-2k+2} x^{2k} \right\}$

6.1.5 Integrands Involving $x^m \ln [x + (x^2 \pm a^2)^{1/2}]$

6.1.5.1

1. $\int \ln [x + (x^2 + a^2)^{1/2}] dx = x \ln [x + (x^2 + a^2)^{1/2}] - (x^2 + a^2)^{1/2}$
2. $\int x \ln [x + (x^2 + a^2)^{1/2}] dx = \frac{1}{4} (2x^2 + a^2) \ln [x + (x^2 + a^2)^{1/2}] - \frac{1}{4} x (x^2 + a^2)^{1/2}$
3. $\int x^2 \ln [x + (x^2 + a^2)^{1/2}] dx = \frac{x^3}{3} \ln [x + (x^2 + a^2)^{1/2}] - \frac{1}{9} (x^2 + a^2)^{3/2} + \frac{a^2}{3} (x^2 + a^2)^{1/2}$
4. $\int x^3 \ln [x + (x^2 + a^2)^{1/2}] dx = \frac{1}{32} (8x^4 - 3a^4) \ln [x + (x^2 + a^2)^{1/2}] + \frac{1}{32} (3a^2 x - 2x^3) (x^2 + a^2)^{1/2}$
5. $\int \ln [x + (x^2 - a^2)^{1/2}] dx = x \ln [x + (x^2 - a^2)^{1/2}] - (x^2 - a^2)^{1/2}$

$$6. \int x \ln [x + (x^2 - a^2)^{1/2}] dx = \frac{1}{4} (2x^2 - a^2) \ln [x + (x^2 - a^2)^{1/2}] - \frac{1}{4} x (x^2 - a^2)^{1/2}$$

$$7. \int x^2 \ln [x + (x^2 - a^2)^{1/2}] dx = \frac{x^3}{3} \ln [x + (x^2 - a^2)^{1/2}] \\ - \frac{1}{9} (x^2 - a^2)^{3/2} - \frac{a^2}{3} (x^2 - a^2)^{1/2}$$

$$8. \int x^3 \ln [x + (x^2 - a^2)^{1/2}] dx = \frac{1}{32} (8x^4 - 3a^4) \ln [x + (x^2 - a^2)^{1/2}] \\ - \frac{1}{32} (2x^3 + 3a^2x) (x^2 - a^2)^{1/2}$$

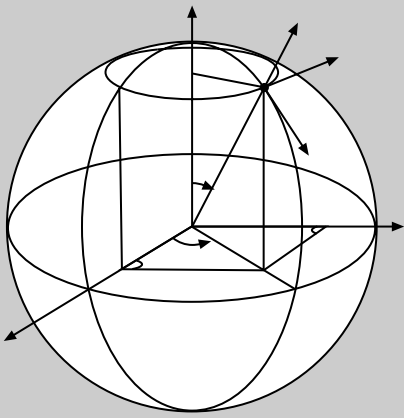

Chapter 7

Indefinite Integrals of Hyperbolic Functions

7.1 BASIC RESULTS

7.1.1 Integrands Involving $\sinh(a + bx)$ and $\cosh(a + bx)$

7.1.1.1

1. $\int \sinh(a + bx) dx = \frac{1}{b} \cosh(a + bx)$
2. $\int \cosh(a + bx) dx = \frac{1}{b} \sinh(a + bx)$
3. $\int \tanh(a + bx) dx = \int \frac{\sinh(a + bx)}{\cosh(a + bx)} dx = \frac{1}{b} \ln [\cosh(a + bx)]$
 $= \frac{1}{b} \ln [\exp(2a + 2bx) + 1] - x$
4. $\int \operatorname{sech}(a + bx) dx = \int \frac{dx}{\cosh(a + bx)} = \frac{2}{b} \arctan[\exp(a + bx)]$
5. $\int \operatorname{csch}(a + bx) dx = \int \frac{dx}{\sinh(a + bx)} = \frac{1}{b} \ln \left| \tanh \frac{1}{2} (a + bx) \right|$
 $= \frac{1}{b} \ln \left| \frac{\exp(a + bx) - 1}{\exp(a + bx) + 1} \right|$

$$\begin{aligned}
 6. \quad \int \coth(a + bx) dx &= \int \frac{\cosh(a + bx)}{\sinh(a + bx)} dx = \frac{1}{b} \ln|\sinh(a + bx)| \\
 &= \frac{1}{b} |\exp(2a + 2bx) - 1| - x
 \end{aligned}$$

7.2 INTEGRANDS INVOLVING POWERS OF $\sinh(bx)$ OR $\cosh(bx)$

7.2.1 Integrands Involving Powers of $\sinh(bx)$

7.2.1.1

$$\begin{aligned}
 1. \quad \int \sinh(bx) dx &= \frac{1}{b} \cosh(bx) \\
 2. \quad \int \sinh^2(bx) dx &= \frac{1}{4b} \sinh(2bx) - \frac{1}{2}x \\
 3. \quad \int \sinh^3(bx) dx &= \frac{1}{12b} \cosh(3bx) - \frac{3}{4b} \cosh(bx) \\
 4. \quad \int \sinh^4(bx) dx &= \frac{1}{32b} \sinh(4bx) - \frac{1}{4b} \sinh(2bx) + \frac{3}{8}x \\
 5. \quad \int \sinh^5(bx) dx &= \frac{1}{80b} \cosh(5bx) - \frac{5}{48b} \cosh(3bx) + \frac{5}{8b} \cosh(bx) \\
 6. \quad \int \sinh^6(bx) dx &= \frac{1}{192b} \sinh(6bx) - \frac{3}{64b} \sinh(4bx) + \frac{15}{64b} \sinh(2bx) - \frac{5}{16}x
 \end{aligned}$$

To evaluate integrals of the form $\int \sinh^m(a + bx) dx$, make the change of variable $a + bx = u$, and then use the result

$$\int \sinh^m(a + bx) dx = \frac{1}{b} \int \sinh^m u du,$$

together with 7.2.1.1.1–6.

7.2.2 Integrands Involving Powers of $\cosh(bx)$

7.2.2.1

$$\begin{aligned}
 1. \quad \int \cosh(bx) dx &= \frac{1}{b} \sinh(bx) \\
 2. \quad \int \cosh^2(bx) dx &= \frac{1}{4b} \sinh(2bx) + \frac{x}{2}
 \end{aligned}$$

3. $\int \cosh^3(bx) dx = \frac{1}{12b} \sinh(3bx) + \frac{3}{4b} \sinh(bx)$
4. $\int \cosh^4(bx) dx = \frac{1}{32b} \sinh(4bx) + \frac{1}{4b} \sinh(2bx) + \frac{3}{8}x$
5. $\int \cosh^5(bx) dx = \frac{1}{80b} \sinh(5bx) + \frac{5}{48b} \sinh(3bx) + \frac{5}{8b} \sinh(bx)$
6. $\int \cosh^6(bx) dx = \frac{1}{192b} \sinh(6bx) + \frac{3}{64b} \sinh(4bx) + \frac{15}{64b} \sinh(2bx) + \frac{5}{16}x$

To evaluate integrals of the form $\int \cosh^m(a + bx) dx$, make the change of variable $a + bx = u$, and then use the result

$$\int \cosh^m(a + bx) dx = \frac{1}{b} \int \cosh^m u du,$$

together with 7.2.2.1.1–6.

7.3 INTEGRANDS INVOLVING $(a + bx)^m \sinh(cx)$ OR $(a + bx)^m \cosh(cx)$

7.3.1 General Results

7.3.1.1

1. $\int (a + bx) \sinh(cx) dx = \frac{1}{c} (a + bx) \cosh(cx) - \frac{b}{c^2} \sinh(cx)$
2. $\int (a + bx)^2 \sinh(cx) dx = \frac{1}{c} \left((a + bx)^2 + \frac{2b^2}{c^2} \right) \cosh(cx) - \frac{2b(a + bx)}{c^2} \sinh(cx)$
3. $\int (a + bx)^3 \sinh(cx) dx = \left(\frac{a + bx}{c} \right) \left((a + bx)^2 + \frac{6b^2}{c^2} \right) \cosh(cx) - \frac{3b}{c^2} \left((a + bx)^2 + \frac{2b^2}{c^2} \right) \sinh(cx)$
4. $\int (a + bx)^4 \sinh(cx) dx = \frac{1}{c} \left((a + bx)^4 + \frac{12b^2}{c^2} (a + bx)^2 + \frac{24b^4}{c^4} \right) \cosh(cx) - \frac{4b(a + bx)}{c^2} \left((a + bx)^2 + \frac{6b^2}{c^2} \right) \sinh(cx)$
5. $\int (a + bx) \cosh(cx) dx = \frac{1}{c} (a + bx) \sinh(cx) - \frac{b}{c^2} \cosh(cx)$

$$6. \int (a + bx)^2 \cosh(cx) dx = \frac{1}{c} \left((a + bx)^2 + \frac{2b^2}{c^2} \right) \sinh(cx) - \frac{2b(a + bx)}{c^2} \cosh(cx)$$

$$7. \int (a + bx)^3 \cosh(cx) dx = \left(\frac{a + bx}{c} \right) \left((a + bx)^2 + \frac{6b^2}{c^2} \right) \sinh(cx) \\ - \frac{3b}{c^2} \left((a + bx)^2 + \frac{2b^2}{c^2} \right) \cosh(cx)$$

$$8. \int (a + bx)^4 \cosh(cx) dx = \frac{1}{c} \left((a + bx)^4 + \frac{12b^2}{c^2} (a + bx)^2 + \frac{24b^4}{c^2} \right) \sinh(cx) \\ - \frac{4b(a + bx)}{c^2} \left((a + bx)^2 + \frac{6b^2}{c^2} \right) \cosh(cx)$$

7.3.1.2 Special Cases $a = 0$, $b = c = 1$

$$1. \int x \sinh x dx = x \cosh x - \sinh x$$

$$2. \int x^2 \sinh x dx = (x^2 + 2) \cosh x - 2x \sinh x$$

$$3. \int x^3 \sinh x dx = (x^3 + 6x) \cosh x - (3x^2 + 6) \sinh x$$

$$4. \int x^4 \sinh x dx = (x^4 + 12x^2 + 24) \cosh x - 4x(x^2 + 6) \sinh x$$

$$5. \int x^n \sinh x dx = x^n \cosh x - n \int x^{n-1} \cosh x dx$$

$$6. \int x \cosh x dx = x \sinh x - \cosh x$$

$$7. \int x^2 \cosh x dx = (x^2 + 2) \sinh x - 2x \cosh x$$

$$8. \int x^3 \cosh x dx = (x^3 + 6x) \sinh x - (3x^2 + 6) \cosh x$$

$$9. \int x^4 \cosh x dx = (x^4 + 12x^2 + 24) \sinh x - 4x(x^2 + 6) \cosh x$$

$$10. \int x^n \cosh x dx = x^n \sinh x - n \int x^{n-1} \sinh x dx$$

7.4 INTEGRANDS INVOLVING $x^m \sinh^n x$ OR $x^m \cosh^n x$ **7.4.1 Integrands Involving $x^m \sinh^n x$** **7.4.1.1**

$$1. \int x \sinh^2 x \, dx = \frac{1}{4}x \sinh 2x - \frac{1}{8} \cosh 2x - \frac{1}{4}x^2$$

$$2. \int x^2 \sinh^2 x \, dx = \frac{1}{4} \left(x^2 + \frac{1}{2} \right) \sinh 2x - \frac{1}{4}x \cosh 2x - \frac{1}{6}x^3$$

$$3. \int x \sinh^3 x \, dx = \frac{3}{4} \sinh x - \frac{1}{36} \sinh 3x - \frac{3}{4}x \cosh x + \frac{1}{12}x \cosh 3x$$

$$4. \int x^2 \sinh^3 x \, dx = - \left(\frac{3x^2}{4} + \frac{3}{2} \right) \cosh x + \left(\frac{x^2}{12} + \frac{1}{54} \right) \cosh 3x + \frac{3}{2}x \sinh x - \frac{1}{18}x \sinh 3x$$

7.4.2 Integrands Involving $x^m \cosh^n x$ **7.4.2.1**

$$1. \int x \cosh^2 x \, dx = \frac{1}{4}x \sinh 2x - \frac{1}{8} \cosh 2x + \frac{1}{4}x^2$$

$$2. \int x^2 \cosh^2 x \, dx = \frac{1}{4} \left(x^2 + \frac{1}{2} \right) \sinh 2x - \frac{1}{4}x \cosh 2x + \frac{1}{6}x^3$$

$$3. \int x \cosh^3 x \, dx = -\frac{3}{4} \cosh x - \frac{1}{36} \cosh 3x + \frac{3}{4}x \sinh x + \frac{1}{12}x \sinh 3x$$

$$4. \int x^2 \cosh^3 x \, dx = \left(\frac{3x^2}{4} + \frac{3}{2} \right) \sinh x + \left(\frac{x^2}{12} + \frac{1}{54} \right) \sinh 3x - \frac{3}{2}x \cosh x - \frac{1}{18}x \cosh 3x$$

7.5 INTEGRANDS INVOLVING $x^m \sinh^{-n} x$ OR $x^m \cosh^{-n} x$ **7.5.1 Integrands Involving $x^m \sinh^{-n} x$** **7.5.1.1**

$$1. \int \frac{dx}{\sinh x} = \ln \left| \tanh \frac{x}{2} \right|$$

$$2. \int \frac{x dx}{\sinh x} = \sum_{k=0}^{\infty} \frac{(2-2^{2k}) B_{2k}}{(2k+1)(2k)!} x^{2k+1} \quad [|x| < \pi] \quad (\text{see 1.3.1.1})$$

$$3. \int \frac{x^n dx}{\sinh x} = \sum_{k=0}^{\infty} \frac{(2-2^{2k}) B_{2k}}{(2k+n)(2k)!} x^{2k+n} \quad [|x| < \pi] \quad (\text{see 1.3.1.1})$$

$$4. \int \frac{dx}{\sinh^2 x} = -\coth x$$

$$5. \int \frac{x dx}{\sinh^2 x} = -x \coth x + \ln|\sinh x|$$

$$6. \int \frac{dx}{\sinh^3 x} = -\frac{\cosh x}{2 \sinh^2 x} - \frac{1}{2} \ln \left| \tanh \frac{x}{2} \right|$$

$$7. \int \frac{x dx}{\sinh^3 x} = -\frac{x \cosh x}{2 \sinh^2 x} - \frac{1}{2 \sinh x} - \frac{1}{2} \int \frac{x dx}{\sinh x}$$

$$8. \int \frac{dx}{\sinh^4 x} = \coth x - \frac{1}{3} \coth^3 x$$

7.5.2 Integrands Involving $x^m \cosh^{-n} x$

7.5.2.1

$$1. \int \frac{dx}{\cosh x} = \arctan(\sinh x) = 2 \arctan e^x$$

$$2. \int \frac{x dx}{\cosh x} = \sum_{k=0}^{\infty} \frac{E_{2k}}{(2k+2)(2k)!} x^{2k+2} \quad \left[|x| < \frac{\pi}{2} \right] \quad (\text{see 1.3.1.1})$$

$$3. \int \frac{x^n dx}{\cosh x} = \sum_{k=0}^{\infty} \frac{E_{2k}}{(2k+n+1)(2k)!} x^{2k+n+1} \quad \left[|x| < \frac{\pi}{2} \right] \quad (\text{see 1.3.1.1})$$

$$4. \int \frac{dx}{\cosh^2 x} = \tanh x$$

$$5. \int \frac{x dx}{\cosh^2 x} = x \tanh x - \ln(\cosh x)$$

$$6. \int \frac{dx}{\cosh^3 x} = \frac{\sinh x}{2 \cosh^2 x} + \frac{1}{2} \arctan(\sinh x)$$

$$7. \int \frac{x dx}{\cosh^3 x} = \frac{x \sinh x}{2 \cosh^2 x} + \frac{1}{2 \cosh x} + \frac{1}{2} \int \frac{x dx}{\cosh x}$$

$$8. \int \frac{dx}{\cosh^4 x} = \tanh x - \frac{1}{3} \tanh^3 x$$

7.6 INTEGRANDS INVOLVING $(1 \pm \cosh x)^{-m}$ **7.6.1 Integrands Involving $(1 \pm \cosh x)^{-1}$** **7.6.1.1**

1.
$$\int \frac{dx}{1 + \cosh x} = \tanh \frac{x}{2}$$

2.
$$\int \frac{dx}{1 - \cosh x} = \coth \frac{x}{2}$$

3.
$$\int \frac{x dx}{1 + \cosh x} = x \tanh \frac{x}{2} - 2 \ln \left(\cosh \frac{x}{2} \right)$$

4.
$$\int \frac{x dx}{1 - \cosh x} = x \coth \frac{x}{2} - 2 \ln \left| \sinh \frac{x}{2} \right|$$

5.
$$\int \frac{\cosh x dx}{1 + \cosh x} = x - \tanh \frac{x}{2}$$

6.
$$\int \frac{\cosh x dx}{1 - \cosh x} = \coth \frac{x}{2} - x$$

7.6.2 Integrands Involving $(1 \pm \cosh x)^{-2}$ **7.6.2.1**

1.
$$\int \frac{dx}{(1 + \cosh x)^2} = \frac{1}{2} \tanh \frac{x}{2} - \frac{1}{6} \tanh^3 \frac{x}{2}$$

2.
$$\int \frac{dx}{(1 - \cosh x)^2} = \frac{1}{2} \coth \frac{x}{2} - \frac{1}{6} \coth^3 \frac{x}{2}$$

3.
$$\int \frac{x \sinh x dx}{(1 + \cosh x)^2} = -\frac{x}{\cosh x + 1} + \tanh \frac{x}{2}$$

4.
$$\int \frac{x \sinh x dx}{(1 - \cosh x)^2} = -\frac{x}{\cosh x - 1} - \coth \frac{x}{2}$$

7.7 INTEGRANDS INVOLVING $\sinh(ax) \cosh^{-n} x$ OR $\cosh(ax) \sinh^{-n} x$ **7.7.1 Integrands Involving $\sinh(ax) \cosh^{-n} x$** **7.7.1.1**

1.
$$\int \frac{\sinh 2x}{\cosh^n x} dx = \left(\frac{2}{2-n} \right) \cosh^{2-n} x \quad [n \neq 2]$$

2. $\int \frac{\sinh 2x}{\cosh^2 x} dx = 2 \ln(\cosh x) \quad [\text{case } n = 2]$
3. $\int \frac{\sinh 3x}{\cosh^n x} dx = \left(\frac{4}{3-n}\right) \cosh^{3-n} x - \left(\frac{1}{1-n}\right) \cosh^{1-n} x \quad [n \neq 1, 3]$
4. $\int \frac{\sinh 3x}{\cosh x} dx = 2 \sinh^2 x - \ln(\cosh x) \quad [\text{case } n = 1]$
5. $\int \frac{\sinh 3x}{\cosh^3 x} dx = -\frac{1}{2} \tanh^2 x + 4 \ln(\cosh x) \quad [\text{case } n = 3]$

7.7.2 Integrands Involving $\cosh(ax) \sinh^{-n} x$

7.7.2.1

1. $\int \frac{\cosh 2x}{\sinh x} dx = 2 \cosh x + \ln \left| \tanh \frac{x}{2} \right|$
2. $\int \frac{\cosh 2x}{\sinh^2 x} dx = -\coth x + 2x$
3. $\int \frac{\cosh 2x}{\sinh^3 x} dx = -\frac{\cosh x}{2 \sinh^2 x} + \frac{3}{2} \ln \left| \tanh \frac{x}{2} \right|$
4. $\int \frac{\cosh 3x}{\sinh^n x} dx = \left(\frac{4}{3-n}\right) \sinh^{3-n} x + \left(\frac{1}{1-n}\right) \sinh^{1-n} x \quad [n \neq 1, 3]$
5. $\int \frac{\cosh 3x}{\sinh x} dx = 2 \sinh^2 x + \ln |\sinh x| \quad [\text{case } n = 1]$
6. $\int \frac{\cosh 3x}{\sinh^3 x} dx = -\frac{1}{2} \coth^2 x + 4 \ln |\sinh x| \quad [\text{case } n = 3]$

7.8 INTEGRANDS INVOLVING $\sinh(ax + b)$ AND $\cosh(cx + d)$

7.8.1 General Case

7.8.1.1

1. $\int \sinh(ax + b) \sinh(cx + d) dx = \frac{1}{2(a+c)} \sinh[(a+c)x + b+d]$

$$- \frac{1}{2(a-c)} \sinh[(a-c)x + b-d] \quad [a^2 \neq c^2]$$

$$2. \int \sinh(ax + b) \cosh(cx + d) dx = \frac{1}{2(a+c)} \cosh[(a+c)x + b + d] \\ + \frac{1}{2(a-c)} \cosh[(a-c)x + b - d] \quad [a^2 \neq c^2]$$

$$3. \int \cosh(ax + b) \cosh(cx + d) dx = \frac{1}{2(a+c)} \sinh[(a+c)x + b + d] \\ + \frac{1}{2(a-c)} \sinh[(a-c)x + b - d] \quad [a^2 \neq c^2]$$

7.8.2 Special Case $a = c$

7.8.2.1

$$1. \int \sinh(ax + b) \sinh(ax + d) dx = -\frac{1}{2}x \cosh(b - d) + \frac{1}{4a} \sinh(2ax + b + d)$$

$$2. \int \sinh(ax + b) \cosh(ax + d) dx = \frac{1}{2}x \sinh(b - d) + \frac{1}{4a} \cosh(2ax + b + d)$$

$$3. \int \cosh(ax + b) \cosh(ax + d) dx = \frac{1}{2}x \cosh(b - d) + \frac{1}{4a} \sinh(2ax + b + d)$$

7.8.3 Integrands Involving $\sinh^p x \cosh^q x$

7.8.3.1

$$1. \int \frac{\sinh^{2m} x}{\cosh x} dx = \sum_{k=1}^m \frac{(-1)^{m+k}}{2k-1} \sinh^{2k-1} x + (-1)^m \arctan(\sinh x) \quad [m \geq 1]$$

$$2. \int \frac{\sinh^{2m+1} x}{\cosh x} dx = \sum_{k=1}^m \frac{(-1)^{m+k}}{2k} \sinh^{2k} x + (-1)^m \ln(\cosh x) \quad [m \geq 1]$$

$$3. \int \frac{dx}{\sinh^{2m} x \cosh x} = \sum_{k=1}^m \frac{(-1)^k \operatorname{cosech}^{2m-2k+1} x}{2m-2k+1} + (-1)^m \arctan(\sinh x) \quad [m \geq 1]$$

$$4. \int \frac{dx}{\sinh^{2m+1} x \cosh x} = \sum_{k=1}^m \frac{(-1)^k \operatorname{cosech}^{2m-2k+2} x}{2m-2k+2} + (-1)^m \ln|\tanh x|$$

$$5. \int \frac{\cosh^{2m} x}{\sinh x} dx = \sum_{k=1}^m \frac{\cosh^{2k-1} x}{2k-1} + \ln \left| \tanh \frac{x}{2} \right|$$

6. $\int \frac{\cosh^{2m+1} x}{\sinh x} dx = \sum_{k=1}^m \frac{\cosh^{2k} x}{2k} + \ln|\sinh x|$
7. $\int \frac{dx}{\sinh x \cosh^{2m} x} = \sum_{k=1}^m \frac{\operatorname{sech}^{2m-2k+1} x}{2m-2k+1} + \ln \left| \tanh \frac{x}{2} \right|$
8. $\int \frac{dx}{\sinh x \cosh^{2m+1} x} = \sum_{k=1}^m \frac{\operatorname{sech}^{2m-2k+2} x}{2m-2k+2} + \ln \left| \tanh \frac{x}{2} \right|$

7.9 INTEGRANDS INVOLVING $\tanh kx$ AND $\coth kx$

7.9.1 Integrands involving $\tanh kx$

7.9.1.1

1. $\int \tanh kx dx = \frac{1}{k} \ln(\cosh kx)$
2. $\int \tanh^2 kx dx = x - \frac{1}{k} \tanh kx$
3. $\int \tanh^3 kx dx = \frac{1}{k} \ln(\cosh kx) - \frac{1}{2k} \tanh^2 kx$
4. $\int \tanh^{2n} kx dx = x - \frac{1}{k} \sum_{k=1}^n \frac{\tanh^{2n-2k+1} kx}{2n-2k+1}$
5. $\int \tanh^{2n+1} kx dx = \frac{1}{k} \ln(\cosh kx) - \frac{1}{k} \sum_{k=1}^n \frac{\tanh^{2n-2k+2} kx}{2n-2k+2}$

7.9.2 Integrands Involving $\coth kx$

7.9.2.1

1. $\int \coth kx dx = \frac{1}{k} \ln|\sinh kx|$
2. $\int \coth^2 kx dx = x - \frac{1}{k} \coth kx$
3. $\int \coth^3 kx dx = \frac{1}{k} \ln|\sinh kx| - \frac{1}{2k} \coth^2 kx$
4. $\int \coth^{2n} kx dx = x - \frac{1}{k} \sum_{k=1}^n \frac{\coth^{2n-2k+1} kx}{2n-2k+1}$

$$5. \int \coth^{2n+1} kx \, dx = \frac{1}{k} \ln|\sinh kx| - \frac{1}{k} \sum_{k=1}^n \frac{\coth^{2n-2k+2} kx}{2n - 2k + 2}$$

7.10 INTEGRANDS INVOLVING $(a + bx)^m \sinh kx$ OR $(a + bx)^m \cosh kx$

7.10.1 Integrands Involving $(a + bx)^m \sinh kx$

7.10.1.1

$$1. \int (a + bx) \sinh kx \, dx = \frac{1}{k}(a + bx) \cosh kx - \frac{b}{k^2} \sinh kx$$

$$2. \int (a + bx)^2 \sinh kx \, dx = \frac{1}{k} \left((a + bx)^2 + \frac{2b^2}{k^2} \right) \cosh kx - \frac{2b(a + bx)}{k^2} \sinh kx$$

$$3. \int (a + bx)^3 \sinh kx \, dx = \frac{(a + bx)}{k} \left((a + bx)^2 + \frac{6b^2}{k^2} \right) \cosh kx \\ - \frac{3b}{k^2} \left((a + bx)^2 + \frac{2b^2}{k^2} \right) \sinh kx$$

7.10.2 Integrands Involving $(a + bx)^m \cosh kx$

7.10.2.1

$$1. \int (a + bx) \cosh kx \, dx = \frac{1}{k}(a + bx) \sinh kx - \frac{b}{k^2} \cosh kx$$

$$2. \int (a + bx)^2 \cosh kx \, dx = \frac{1}{k} \left((a + bx)^2 + \frac{2b^2}{k^2} \right) \sinh kx - \frac{2b(a + bx)}{k^2} \cosh kx$$

$$3. \int (a + bx)^3 \cosh kx \, dx = \frac{(a + bx)}{k} \left((a + bx)^2 + \frac{6b^2}{k^2} \right) \sinh kx \\ - \frac{3b}{k^2} \left((a + bx)^2 + \frac{2b^2}{k^2} \right) \cosh kx$$

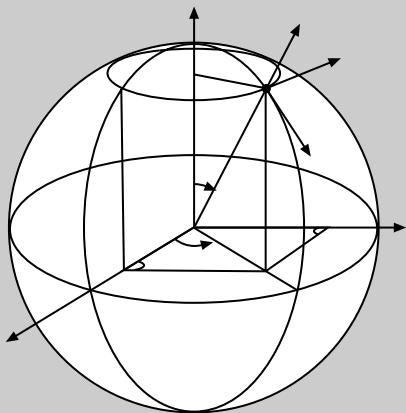

Chapter 8

Indefinite Integrals Involving Inverse Hyperbolic Functions

8.1 BASIC RESULTS

8.1.1 Integrands Involving Products of x^n and $\operatorname{arcsinh}(x/a)$ or $\operatorname{arccosh}(x/c)$

8.1.1.1 Integrands Involving Products x^n and $\operatorname{arcsinh}(x/a)$

1. $\int \operatorname{arcsinh} \frac{x}{a} dx = x \operatorname{arcsinh} \frac{x}{a} - (x^2 + a^2)^{1/2} \quad [a > 0]$
2. $\int x \operatorname{arcsinh} \frac{x}{a} dx = \frac{1}{4} (2x^2 + a^2) \operatorname{arcsinh} \frac{x}{a} - \frac{1}{4} x (x^2 + a^2)^{1/2} \quad [a > 0]$
3. $\int x^2 \operatorname{arcsinh} \frac{x}{a} dx = \frac{1}{3} x^3 \operatorname{arcsinh} \frac{x}{a} + \frac{1}{9} (2a^2 - x^2) (x^2 + a^2)^{1/2} \quad [a > 0]$
4. $\int x^3 \operatorname{arcsinh} \frac{x}{a} dx = \frac{1}{32} (8x^4 - 3a^4) \operatorname{arcsinh} \frac{x}{a} + \frac{1}{32} (3a^2 x - 2x^3) (x^2 + a^2)^{1/2} \quad [a > 0]$
5. $\int x^n \operatorname{arcsinh} \frac{x}{a} dx = \frac{x^{n+1}}{n+1} \operatorname{arcsinh} \frac{x}{a} - \frac{1}{n+1} \int \frac{x^{n+1} dx}{(x^2 + a^2)^{1/2}} \quad (\text{see 4.3.3})$

8.1.1.2 Integrands Involving $x^n \operatorname{arccosh}(x/a)$

1. $\int \operatorname{arccosh} \frac{x}{a} dx = x \operatorname{arccosh} \frac{x}{a} - (x^2 + a^2)^{1/2} \quad [\operatorname{arccosh}(x/a) > 0]$
 $= x \operatorname{arccosh} \frac{x}{a} + (x^2 - a^2)^{1/2} \quad [\operatorname{arccosh}(x/a) < 0]$

2. $\int x \operatorname{arccosh} \frac{x}{a} dx$
- $$= \frac{1}{4} (2x^2 - a^2) \operatorname{arccosh} \frac{x}{a} - \frac{1}{4} x (x^2 - a^2)^{1/2} \quad [\operatorname{arccosh} (x/a) > 0]$$
- $$= \frac{1}{4} (2x^2 - a^2) \operatorname{arccosh} \frac{x}{a} + \frac{1}{4} x (x^2 - a^2)^{1/2} \quad [\operatorname{arccosh} (x/a) < 0]$$
3. $\int x^2 \operatorname{arccosh} \frac{x}{a} dx$
- $$= \frac{1}{3} x^3 \operatorname{arccosh} \frac{x}{a} - \frac{1}{9} (2a^2 + x^2) (x^2 - a^2)^{1/2} \quad [\operatorname{arccosh} (x/a) > 0]$$
- $$= \frac{1}{3} x^3 \operatorname{arccosh} \frac{x}{a} + \frac{1}{9} (2a^2 + x^2) (x^2 - a^2)^{1/2} \quad [\operatorname{arccosh} (x/a) < 0]$$
4. $\int x^3 \operatorname{arccosh} \frac{x}{a} dx$
- $$= \frac{1}{32} (8x^4 - 3a^4) \operatorname{arccosh} \frac{x}{a} - \frac{1}{32} (3a^2 x + 2x^3) (x^2 - a^2)^{1/2} \quad [\operatorname{arccosh} (x/a) > 0]$$
- $$= \frac{1}{32} (8x^4 - 3a^4) \operatorname{arccosh} \frac{x}{a} + \frac{1}{32} (3a^2 x + 2x^3) (x^2 - a^2)^{1/2} \quad [\operatorname{arccosh} (x/a) < 0]$$
5. $\int x^n \operatorname{arccosh} \frac{x}{a} dx = \frac{x^{n+1}}{n+1} \operatorname{arccosh} \frac{x}{a} - \frac{1}{n+1} \int \frac{x^{n+1} dx}{(x^2 - a^2)^{1/2}}$
- [$\operatorname{arccosh} (x/a) > 0, n \neq -1$] (see 4.3.3)
- $$= \frac{x^{n+1}}{n+1} \operatorname{arccosh} \frac{x}{a} + \frac{1}{n+1} \int \frac{x^{n+1} dx}{(x^2 - a^2)^{1/2}}$$
- [$\operatorname{arccosh} (x/a) < 0, n \neq -1$] (see 4.3.3)

8.2 INTEGRANDS INVOLVING $x^{-n} \operatorname{arcsinh} (x/a)$ OR $x^{-n} \operatorname{arccosh} (x/a)$

8.2.1 Integrands Involving $x^{-n} \operatorname{arcsinh} (x/a)$

8.2.1.1

$$1. \int \frac{1}{x} \operatorname{arcsinh} \frac{x}{a} dx = \frac{x}{a} - \frac{1}{2 \cdot 3 \cdot 3} \frac{x^3}{a^3} + \frac{1 \cdot 3}{2 \cdot 4 \cdot 5 \cdot 5} \frac{x^5}{a^5} - \frac{1 \cdot 3 \cdot 5}{2 \cdot 4 \cdot 6 \cdot 7 \cdot 7} \frac{x^7}{a^7} + \cdots \quad [x^2 < a^2]$$

$$2. \int \frac{1}{x^2} \operatorname{arcsinh} \frac{x}{a} dx = -\frac{1}{x} \operatorname{arcsinh} \frac{x}{a} - \frac{1}{a} \ln \left| \frac{a + (x^2 + a^2)^{1/2}}{x} \right|$$

3.
$$\int \frac{1}{x^3} \operatorname{arcsinh} \frac{x}{a} dx = -\frac{1}{2x^2} \operatorname{arcsinh} \frac{x}{a} - \frac{1}{2ax} \left(1 + \frac{x^2}{a^2}\right)^{1/2}$$
4.
$$\int \frac{1}{x^4} \operatorname{arcsinh} \frac{x}{a} dx = -\frac{1}{3x^3} \operatorname{arcsinh} \frac{x}{a} + \frac{1}{6a^3} \operatorname{arcsinh}(a/x) - \frac{1}{6ax^2} \left(1 + \frac{x^2}{a^2}\right)^{1/2}$$
5.
$$\int \frac{1}{x^n} \operatorname{arcsinh} \frac{x}{a} dx = -\frac{1}{(n-1)x^{n-1}} \operatorname{arcsinh} \frac{x}{a} + \frac{1}{n-1} \int \frac{dx}{x^{n-1}(x^2+a^2)^{1/2}} \quad (\text{see 4.3.3})$$

8.2.2 Integrands Involving $x^{-n} \operatorname{arccosh}(x/a)$

8.2.2.1

1.
$$\int \frac{1}{x} \operatorname{arccosh} \frac{x}{a} dx$$

$$= \frac{1}{2} \left(\ln \frac{2x}{a} \right)^2 + \frac{1}{2^3} \frac{a^2}{x^2} + \frac{1 \cdot 3}{2 \cdot 4^3} \frac{a^4}{x^4} + \frac{1 \cdot 3 \cdot 5}{2 \cdot 4 \cdot 6^3} \frac{a^6}{x^6} + \dots \quad [\operatorname{arccosh}(x/a) > 0]$$

$$= - \left[\frac{1}{2} \left(\ln \frac{2x}{a} \right)^2 + \frac{1}{2^3} \frac{a^2}{x^2} + \frac{1 \cdot 3}{2 \cdot 4^3} \frac{a^4}{x^4} + \frac{1 \cdot 3 \cdot 5}{2 \cdot 4 \cdot 6^3} \frac{a^6}{x^6} + \dots \right] \quad [\operatorname{arccosh}(x/a) < 0]$$
2.
$$\int \frac{1}{x^2} \operatorname{arccosh} \frac{x}{a} dx = -\frac{1}{x} \operatorname{arccosh} \frac{x}{a} - \frac{1}{a} \arcsin(a/x)$$
3.
$$\int \frac{1}{x^3} \operatorname{arccosh} \frac{x}{a} dx = -\frac{1}{2x^2} \operatorname{arccosh} \frac{x}{a} + \frac{1}{2ax} \left(\frac{x^2}{a^2} - 1 \right)^{1/2} \quad [x^2 > a^2]$$
4.
$$\int \frac{1}{x^4} \operatorname{arccosh} \frac{x}{a} dx = -\frac{1}{3x^3} \operatorname{arccosh} \frac{x}{a} - \frac{1}{6a^3} \arcsin(a/x) + \frac{1}{6ax^2} \left(\frac{x^2}{a^2} - 1 \right)^{1/2} \quad [x^2 > a^2]$$
5.
$$\int \frac{1}{x^n} \operatorname{arccosh} \frac{x}{a} dx = -\frac{1}{(n-1)x^{n-1}} \operatorname{arccosh} \frac{x}{a} + \frac{1}{n-1} \int \frac{dx}{x^{n-1}(x^2-a^2)^{1/2}}$$

$$[\operatorname{arccosh}(x/a) > 0, n \neq 1] \quad (\text{see 4.3.3})$$

$$- \frac{1}{(n-1)x^{n-1}} \operatorname{arccosh} \frac{x}{a} - \frac{1}{n-1} \int \frac{dx}{x^{n-1}(x^2-a^2)^{1/2}}$$

$$[\operatorname{arccosh}(x/a) < 0, n \neq 1] \quad (\text{see 4.3.3})$$

8.3 INTEGRANDS INVOLVING $x^n \operatorname{arctanh}(x/a)$ OR $x^n \operatorname{arccoth}(x/a)$

8.3.1 Integrands Involving $x^n \operatorname{arctanh}(x/a)$

- $\int \operatorname{arctanh} \frac{x}{a} dx = x \operatorname{arctanh} \frac{x}{a} + \frac{1}{2} a \ln(a^2 - x^2) \quad [x^2 < a^2]$
- $\int x \operatorname{arctanh} \frac{x}{a} dx = \frac{1}{2} (x^2 - a^2) \operatorname{arctanh} \frac{x}{a} + \frac{1}{2} ax \quad [x^2 < a^2]$
- $\int x^2 \operatorname{arctanh} \frac{x}{a} dx = \frac{1}{3} x^3 \operatorname{arctanh} \frac{x}{a} + \frac{1}{6} ax^2 + \frac{1}{6} a^3 \ln(a^2 - x^2) \quad [x^2 < a^2]$
- $\int x^3 \operatorname{arctanh} \frac{x}{a} dx = \frac{1}{4} (x^4 - a^4) \operatorname{arctanh} \frac{x}{a} + \frac{1}{12} ax^3 + \frac{1}{4} a^3 x \quad [x^2 < a^2]$
- $\int x^4 \operatorname{arctanh} \frac{x}{a} dx = \frac{1}{5} x^5 \operatorname{arctanh} \frac{x}{a} + \frac{1}{20} ax^2 (2a^2 + x^2) + \frac{1}{10} a^5 \ln(x^2 - a^2) \quad [x^2 < a^2]$
- $\int x^n \operatorname{arctanh} \frac{x}{a} dx = -\frac{1}{(n-1)x^{n-1}} \operatorname{arctanh} \frac{x}{a} + \frac{a}{n-1} \int \frac{dx}{x^{n-1}(a^2 - x^2)}$
 $[x^2 < a^2, n \neq 1] \quad (\text{see 4.2.4.9})$

8.3.2 Integrands Involving $x^n \operatorname{arccoth}(x/a)$

8.3.2.1

- $\int \operatorname{arccoth} \frac{x}{a} dx = x \operatorname{arccoth} \frac{x}{a} + \frac{1}{2} a \ln(x^2 - a^2) \quad [a^2 < x^2]$
- $\int x \operatorname{arccoth} \frac{x}{a} dx = \frac{1}{2} (x^2 - a^2) \operatorname{arccoth} \frac{x}{a} + \frac{1}{2} ax \quad [a^2 < x^2]$
- $\int x^2 \operatorname{arccoth} \frac{x}{a} dx = \frac{1}{3} x^3 \operatorname{arccoth} \frac{x}{a} + \frac{1}{6} ax^2 + \frac{1}{6} a^3 \ln(x^2 - a^2) \quad [a^2 < x^2]$
- $\int x^3 \operatorname{arccoth} \frac{x}{a} dx = \frac{1}{4} (x^4 - a^4) \operatorname{arccoth} \frac{x}{a} + \frac{1}{12} ax^3 + \frac{1}{4} a^3 x \quad [a^2 < x^2]$
- $\int x^4 \operatorname{arccoth} \frac{x}{a} dx = \frac{1}{5} x^5 \operatorname{arccoth} \frac{x}{a} + \frac{1}{20} ax^2 (2a^2 + x^2) + \frac{1}{10} a^5 \ln(x^2 - a^2) \quad [a^2 < x^2]$
- $\int x^n \operatorname{arccoth} \frac{x}{a} dx = \frac{x^{n+1}}{n+1} \operatorname{arccoth} \frac{x}{a} - \frac{a}{n+1} \int \frac{x^{n+1} dx}{a^2 - x^2} \quad [a^2 < x^2, n \neq -1] \quad (\text{see 4.2.4})$

8.4 INTEGRANDS INVOLVING $x^{-n} \operatorname{arctanh}(x/a)$ OR $x^{-n} \operatorname{arccoth}(x/a)$ **8.4.1 Integrands Involving $x^{-n} \operatorname{arctanh}(x/a)$** **8.4.1.1**

1. $\int \frac{1}{x} \operatorname{arctanh} \frac{x}{a} dx = \frac{x}{a} + \frac{x^3}{3^2 a^3} + \frac{x^5}{5^2 a^5} + \frac{x^7}{7^2 a^7} + \cdots \quad [x^2 < a^2]$
2. $\int \frac{1}{x^2} \operatorname{arctanh} \frac{x}{a} dx = -\frac{1}{x} \operatorname{arctanh} \frac{x}{a} - \frac{1}{2a} \ln \left(\frac{a^2 - x^2}{x^2} \right) \quad [x^2 < a^2]$
3. $\int \frac{1}{x^3} \operatorname{arctanh} \frac{x}{a} dx = \frac{1}{2} \left(\frac{1}{a^2} - \frac{1}{x^2} \right) \operatorname{arctanh} \frac{x}{a} - \frac{1}{2ax} \quad [x^2 < a^2]$
4. $\int \frac{1}{x^n} \operatorname{arctanh} \frac{x}{a} dx = -\frac{1}{(n-1)x^{n-1}} \operatorname{arctanh} \frac{x}{a} + \frac{a}{n-1} \int \frac{dx}{x^{n-1}(a^2 - x^2)} \quad [x^2 < a^2, n \neq 1]$ (see 4.2.4.9)

8.4.2 Integrands Involving $x^{-n} \operatorname{arccoth}(x/a)$

1. $\int \frac{1}{x} \operatorname{arccoth} \frac{x}{a} dx = -\frac{a}{x} - \frac{a^3}{3^2 x^3} - \frac{a^5}{5^2 x^5} - \frac{a^7}{7^2 x^7} - \cdots \quad [a^2 < x^2]$
2. $\int \frac{1}{x^2} \operatorname{arccoth} \frac{x}{a} dx = -\frac{1}{x} \operatorname{arccoth} \frac{x}{a} - \frac{1}{2a} \ln \left(\frac{x^2 - a^2}{x^2} \right) \quad [a^2 < x^2]$
3. $\int \frac{1}{x^3} \operatorname{arccoth} \frac{x}{a} dx = \frac{1}{2} \left(\frac{1}{a^2} - \frac{1}{x^2} \right) \operatorname{arccoth} \frac{x}{a} - \frac{1}{2ax} \quad [a^2 < x^2]$
4. $\int \frac{1}{x^n} \operatorname{arccoth} \frac{x}{a} dx = -\frac{1}{(n-1)x^{n-1}} \operatorname{arccoth} \frac{x}{a} + \frac{a}{n-1} \int \frac{dx}{x^{n-1}(a^2 - x^2)} \quad [a^2 < x^2, n \neq 1]$ (see 4.2.4.9)

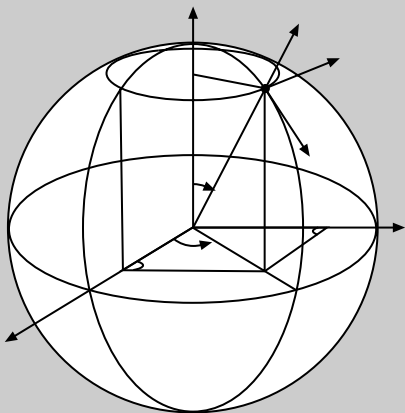

Chapter 9

Indefinite Integrals of Trigonometric Functions

9.1 BASIC RESULTS

9.1.1 Simplification by Means of Substitutions

9.1.1.1

Integrals of the form $\int R(\sin x, \cos x, \tan x, \cot x) dx$, in which R is a rational function in terms of the functions $\sin x$, $\cos x$, $\tan x$, and $\cot x$, but in which x does not appear explicitly, can always be reduced to an integral of a rational function of t by means of the substitution $t = \tan(x/2)$. In terms of this substitution it follows that

$$t = \tan \frac{x}{2}, \quad \sin x = \frac{2t}{1+t^2}, \quad \cos x = \frac{1-t^2}{1+t^2}, \quad \tan x = \frac{2t}{1-t^2},$$

$$\cot x = \frac{1-t^2}{2t}, \quad \text{and} \quad dx = \frac{2dt}{1+t^2}.$$

Thus, for example,

$$\begin{aligned} \int \frac{\cos x dx}{2 + \sin x} &= \int \frac{(1-t^2) dt}{(1+t^2)(1+t+t^2)} \\ &= - \int \frac{2t dt}{1+t^2} + \int \frac{(1+2t) dt}{1+t+t^2} \end{aligned}$$

$$\begin{aligned}
&= -\ln(1+t^2) + \ln(1+t+t^2) + C \\
&= \ln\left(\frac{1+t+t^2}{1+t^2}\right) + C = \ln\left(1 + \frac{t}{1+t^2}\right) + C \\
&= \ln\left(1 + \frac{1}{2}\sin x\right) + C.
\end{aligned}$$

Since this can be written

$$\ln\left[\frac{1}{2}(2 + \sin x)\right] + C = \ln(2 + \sin x) + \ln\frac{1}{2} + C,$$

the term $\ln\frac{1}{2}$ can be combined with the arbitrary constant C , showing that the required indefinite integral can either be written as

$$\ln\left(1 + \frac{1}{2}\sin x\right) + C \quad \text{or as} \quad \ln(2 + \sin x) + C.$$

Other substitutions that are useful in special cases are listed below.

1. If

$$R(\sin x, \cos x) = -R(-\sin x, \cos x),$$

setting $t = \cos x$ and using the results

$$\sin x = (1-t^2)^{1/2} \quad \text{and} \quad dx = \frac{dt}{(1-t^2)^{1/2}}$$

gives

$$\int R(\sin x, \cos x) dx = \int R\left((1-t^2)^{1/2}, t\right) \frac{dt}{(1-t^2)^{1/2}}.$$

2. If

$$R(\sin x, \cos x) = -R(\sin x, -\cos x),$$

setting $t = \sin x$ and using the results

$$\cos x = (1-t^2)^{1/2} \quad \text{and} \quad dx = \frac{dt}{(1-t^2)^{1/2}}$$

gives

$$\int R(\sin x, \cos x) dx = \int R\left(t, (1-t^2)^{1/2}\right) \frac{dt}{(1-t^2)^{1/2}}.$$

3. If

$$R(\sin x, \cos x) = R(-\sin x, -\cos x),$$

setting $t = \tan x$ and using the results

$$\sin x = \frac{t}{(1+t^2)^{1/2}}, \quad \cos x = \frac{1}{(1+t^2)^{1/2}}, \quad dx = \frac{dt}{1+t^2}$$

gives

$$\int R(\sin x, \cos x) dx = \int R\left(\frac{t}{(1+t^2)^{1/2}}, \frac{1}{(1+t^2)^{1/2}}\right) \frac{dt}{1+t^2}.$$

9.2 INTEGRANDS INVOLVING POWERS OF x AND POWERS OF $\sin x$ OR $\cos x$

9.2.1 Integrands Involving $x^n \sin^m x$

9.2.1.1

1. $\int \sin x dx = -\cos x$
2. $\int \sin^2 x dx = -\frac{1}{4} \sin 2x + \frac{1}{2}x = -\frac{1}{2} \sin x \cos x + \frac{1}{2}x$
3. $\int \sin^3 x dx = \frac{1}{12} \cos 3x - \frac{3}{4} \cos x = \frac{1}{3} \cos^3 x - \cos x$
4. $\int \sin^4 x dx = \frac{1}{32} \sin 4x - \frac{1}{4} \sin 2x + \frac{3}{8}x$
 $= -\frac{1}{4} \sin^3 x \cos x - \frac{3}{8} \sin x \cos x + \frac{3}{8}x$
5. $\int \sin^5 x dx = -\frac{1}{80} \cos 5x + \frac{5}{48} \cos 3x - \frac{5}{8} \cos x$
 $= -\frac{1}{5} \sin^4 x \cos x + \frac{4}{15} \cos^3 x - \frac{4}{5} \cos x$
6. $\int \sin^{2n} x dx = \frac{1}{2^{2n}} \binom{2n}{n} x + \frac{(-1)^n}{2^{2n-1}} \sum_{k=0}^{n-1} (-1)^k \binom{2n}{k} \frac{\sin(2n-2k)x}{2n-2k}$
7. $\int \sin^{2n+1} x dx = \frac{1}{2^{2n}} (-1)^{n+1} \sum_{k=0}^n (-1)^k \binom{2n+1}{k} \frac{\cos(2n+1-2k)x}{2n+1-2k}$

$$8. \int x \sin x \, dx = \sin x - x \cos x$$

$$9. \int x^2 \sin x \, dx = 2x \sin x - (x^2 - 2) \cos x$$

$$10. \int x^3 \sin x \, dx = (3x^2 - 6) \sin x - (x^3 - 6x) \cos x$$

$$11. \int x^4 \sin x \, dx = (4x^3 - 24x) \sin x - (x^4 - 12x^2 + 24) \cos x$$

$$12. \int x^{2n} \sin x \, dx = (2n)! \left\{ \sum_{k=0}^n (-1)^{k+1} \frac{x^{2n-2k}}{(2n-2k)!} \cos x \right. \\ \left. + \sum_{k=0}^{n-1} (-1)^k \frac{x^{2n-2k-1}}{(2n-2k-1)!} \sin x \right\}$$

$$13. \int x^{2n+1} \sin x \, dx = (2n+1)! \left\{ \sum_{k=0}^n (-1)^{k+1} \frac{x^{2n-2k+1}}{(2n-2k+1)!} \cos x \right. \\ \left. + \sum_{k=0}^n (-1)^k \frac{x^{2n-2k}}{(2n-2k)!} \sin x \right\}$$

$$14. \int \sin^2 x \, dx = \frac{1}{2}x - \frac{1}{4} \sin 2x$$

$$15. \int x \sin^2 x \, dx = \frac{1}{4}x^2 - \frac{1}{4}x \sin 2x - \frac{1}{8} \cos 2x$$

$$16. \int x^2 \sin^2 x \, dx = \frac{1}{6}x^3 - \frac{1}{4}x \cos 2x - \frac{1}{4} \left(x^2 - \frac{1}{2} \right) \sin 2x$$

$$17. \int x^m \sin^n x \, dx = \frac{x^{m-1} \sin^{n-1} x}{n^2} [m \sin x - nx \cos x] + \left(\frac{n-1}{n} \right) \int x^m \sin^{n-2} x \, dx \\ - \frac{m(m-1)}{n^2} \int x^{m-2} \sin^n x \, dx$$

9.2.2 Integrands Involving $x^{-n} \sin^m x$

9.2.2.1

$$1. \int \frac{\sin x}{x} \, dx = x - \frac{x^3}{3 \cdot 3!} + \frac{x^5}{5 \cdot 5!} - \frac{x^7}{7 \cdot 7!} + \cdots$$

$$2. \int \frac{\sin x}{x^2} \, dx = -\frac{\sin x}{x} + \int \frac{\cos x}{x} \, dx$$

3.
$$\int \frac{\sin x}{x^3} dx = -\frac{\sin x}{2x^2} - \frac{\cos x}{2x} - \frac{1}{2} \int \frac{\sin x}{x} dx$$
4.
$$\int \frac{\sin x}{x^n} dx = -\frac{\sin x}{(n-1)x^{n-1}} - \frac{\cos x}{(n-1)(n-2)x^{n-2}} - \frac{1}{(n-1)(n-2)} \int \frac{\sin x}{x^{n-2}} dx \quad [n > 2]$$
5.
$$\int \frac{\sin^m x}{x^n} dx = -\frac{\sin^{m-1} x [(n-2)\sin x + mx \cos x]}{(n-1)(n-2)x^{n-1}} - \frac{m^2}{(n-1)(n-2)} \\ \times \int \frac{\sin^m x}{x^{n-2}} dx + \frac{m(m-1)}{(n-1)(n-2)} \int \frac{\sin^{m-2} x}{x^{n-2}} dx \quad [n \neq 1, 2]$$

9.2.3 Integrands Involving $x^n \sin^{-m} x$

9.2.3.1

1.
$$\int \frac{dx}{\sin x} = \ln \left| \tan \frac{x}{2} \right| = -\frac{1}{2} \ln \left(\frac{1 + \cos x}{1 - \cos x} \right) \quad [|x| < \pi]$$
2.
$$\int \frac{dx}{\sin^2 x} = -\cot x \quad [|x| < \pi]$$
3.
$$\int \frac{dx}{\sin^3 x} = -\frac{\cos x}{2\sin^2 x} + \frac{1}{2} \ln \left| \tan \frac{x}{2} \right| \quad [|x| < \pi]$$
4.
$$\int \frac{dx}{\sin^n x} = -\frac{\cos x}{(n-1)\sin^{n-1} x} + \left(\frac{n-2}{n-1} \right) \int \frac{dx}{\sin^{n-2} x} \quad [|x| < \pi, n > 1]$$
5.
$$\int \frac{x dx}{\sin x} = x + \sum_{k=1}^{\infty} (-1)^{k+1} \frac{2(2^{2k-1} - 1)}{(2k+1)(2k)!} B_{2k} x^{2k+1} \quad [|x| < \pi]$$
6.
$$\int \frac{x^2 dx}{\sin x} = \frac{x^2}{2} + \sum_{k=1}^{\infty} (-1)^{k+1} \frac{2(2^{2k-1} - 1)}{(2k+2)(2k)!} B_{2k} x^{2k+2} \quad [|x| < \pi]$$
7.
$$\int \frac{x^n dx}{\sin x} = \frac{x^n}{n} + \sum_{k=1}^{\infty} (-1)^{k+1} \frac{2(2^{2k-1} - 1)}{(2k+n)(2k)!} B_{2k} x^{2k+n} \quad [|x| < \pi, n > 0]$$
8.
$$\int \frac{x^n dx}{\sin^2 x} = -x^n \cot x + \left(\frac{n}{n-1} \right) x^{n-1} + n \sum_{k=1}^{\infty} (-1)^k \frac{2^{2k} x^{n+2k-1}}{(n+2k-1)(2k)!} B_{2k} \\ [|x| < \pi, n > 1]$$

9.2.4 Integrands Involving $x^n \cos^m x$

9.2.4.1

$$1. \int \cos x \, dx = \sin x$$

$$2. \int \cos^2 x \, dx = \frac{1}{4} \sin 2x + \frac{1}{2}x = \frac{1}{2} \sin x \cos x + \frac{1}{2}x$$

$$3. \int \cos^3 x \, dx = \frac{1}{12} \sin 3x + \frac{3}{4} \sin x = \sin x - \frac{1}{3} \sin^3 x$$

$$4. \int \cos^4 x \, dx = \frac{1}{32} \sin 4x + \frac{1}{4} \sin 2x + \frac{3}{8}x = \frac{1}{4} \sin x \cos^3 x + \frac{3}{8} \sin x \cos x + \frac{3}{8}x$$

$$5. \int \cos^5 x \, dx = \frac{1}{80} \sin 5x + \frac{5}{48} \sin 3x + \frac{5}{8} \sin x \\ = \frac{1}{5} \cos^4 x \sin x - \frac{4}{15} \sin^3 x + \frac{4}{5} \sin x$$

$$6. \int \cos^{2n} x \, dx = \frac{1}{2^{2n}} \binom{2n}{n} x + \frac{1}{2^{2n-1}} \sum_{k=0}^{n-1} \binom{2n}{k} \frac{\sin(2n-2k)x}{2n-2k}$$

$$7. \int \cos^{2n+1} x \, dx = \frac{1}{2^{2n}} \sum_{k=0}^n \binom{2n+1}{k} \frac{\sin(2n-2k+1)x}{2n-2k+1}$$

$$8. \int x \cos x \, dx = \cos x + x \sin x$$

$$9. \int x^2 \cos x \, dx = 2x \cos x + (x^2 - 2) \sin x$$

$$10. \int x^3 \cos x \, dx = (3x^2 - 6) \cos x + (x^3 - 6x) \sin x$$

$$11. \int x^4 \cos x \, dx = (4x^3 - 24x) \cos x + (x^4 - 12x^2 + 24) \sin x$$

$$12. \int x^{2n} \cos x \, dx = (2n)! \left\{ \sum_{k=0}^n (-1)^k \frac{x^{2n-2k}}{(2n-2k)!} \sin x + \sum_{k=0}^{n-1} (-1)^k \frac{x^{2n-2k-1}}{(2n-2k-1)!} \cos x \right\}$$

$$13. \int x^{2n+1} \cos x \, dx = (2n+1)! \left\{ \sum_{k=0}^n (-1)^k \frac{x^{2n-2k+1}}{(2n-2k+1)!} \sin x \right. \\ \left. + \sum_{k=0}^n (-1)^k \frac{x^{2n-2k}}{(2n-2k)!} \cos x \right\}$$

$$14. \int \cos^2 x \, dx = \frac{1}{2}x + \frac{1}{4} \sin 2x$$

$$15. \int x \cos^2 x \, dx = \frac{1}{4}x^2 + \frac{1}{4}x \sin 2x + \frac{1}{8} \cos 2x$$

$$16. \int x^2 \cos^2 x \, dx = \frac{1}{6}x^3 + \frac{1}{4}x \cos 2x + \frac{1}{4} \left(x^2 - \frac{1}{2} \right) \sin 2x$$

$$17. \int x^m \cos^n x \, dx = \frac{x^{m-1} \cos^{n-1} x}{n^2} [m \cos x + nx \sin x] + \left(\frac{n-1}{n} \right) \int x^m \cos^{n-2} x \, dx \\ - \frac{m(m-1)}{n^2} \int x^{m-2} \cos^n x \, dx$$

9.2.5 Integrands Involving $x^{-n} \cos^m x$

9.2.5.1

$$1. \int \frac{\cos x}{x} \, dx = \ln |x| - \frac{x^2}{2.2!} + \frac{x^4}{4.4!} - \frac{x^6}{6.6!} + \dots$$

$$2. \int \frac{\cos x}{x^2} \, dx = -\frac{\cos x}{x} - \int \frac{\sin x}{x} \, dx$$

$$3. \int \frac{\cos x}{x^3} \, dx = -\frac{\cos x}{2x^2} + \frac{\sin x}{2x} - \frac{1}{2} \int \frac{\cos x}{x} \, dx$$

$$4. \int \frac{\cos x}{x^n} \, dx = -\frac{\cos x}{(n-1)x^{n-1}} + \frac{\sin x}{(n-1)(n-2)x^{n-2}} - \frac{1}{(n-1)(n-2)} \int \frac{\cos x}{x^{n-2}} \, dx \quad [n > 2]$$

$$5. \int \frac{\cos^m x}{x^n} \, dx = -\frac{\cos^{m-1} x [(n-2) \cos x - mx \sin x]}{(n-1)(n-2)x^{n-1}} - \frac{m^2}{(n-1)(n-2)} \int \frac{\cos^m x}{x^{n-2}} \, dx \\ + \frac{m(m-1)}{(n-1)(n-2)} \int \frac{\cos^{m-2} x}{x^{n-2}} \, dx \quad [n \neq 1, 2]$$

9.2.6 Integrands Involving $x^n \cos^{-m} x$

9.2.6.1

$$1. \int \frac{dx}{\cos x} = \ln |\sec x + \tan x| = \ln \left| \tan \left(\frac{\pi}{4} + \frac{x}{2} \right) \right| = \frac{1}{2} \ln \left(\frac{1 + \sin x}{1 - \sin x} \right) \quad \left[|x| < \frac{\pi}{2} \right]$$

$$2. \int \frac{dx}{\cos^2 x} = \tan x \quad \left[|x| < \frac{\pi}{2} \right]$$

3. $\int \frac{dx}{\cos^3 x} = \frac{1}{2} \frac{\sin x}{\cos^2 x} + \frac{1}{2} \ln \left| \tan \left(\frac{\pi}{4} + \frac{x}{2} \right) \right| \quad \left[|x| < \frac{\pi}{2} \right]$
4. $\int \frac{dx}{\cos^n x} = \frac{\sin x}{(n-1) \cos^{n-1} x} + \left(\frac{n-2}{n-1} \right) \int \frac{dx}{\cos^{n-2} x} \quad \left[|x| < \frac{\pi}{2}, n > 1 \right]$
5. $\int \frac{x dx}{\cos x} = \sum_{k=0}^{\infty} \frac{|E_{2k}| x^{2k+2}}{(2k+2)(2k)!} \quad \left[|x| < \frac{\pi}{2} \right]$
6. $\int \frac{x^2 dx}{\cos x} = \sum_{k=0}^{\infty} \frac{|E_{2k}| x^{2k+3}}{(2k+3)(2k)!} \quad \left[|x| < \frac{\pi}{2}, n > 0 \right]$
7. $\int \frac{x^n dx}{\cos x} = \sum_{k=0}^{\infty} \frac{|E_{2k}| x^{2k+n+1}}{(2k+n+1)(2k)!} \quad \left[|x| < \frac{\pi}{2}, n > 0 \right]$
8. $\int \frac{x^n}{\cos^2 x} dx = x^n \tan x + n \sum_{k=1}^{\infty} (-1)^k \frac{2^{2k} (2^{2k} - 1) x^{2k+n-1}}{(2k+n-1)(2k)!} B_{2k} \quad \left[|x| < \frac{\pi}{2}, n > 1 \right]$

9.2.7 Integrands Involving $x^n \sin x / (a + b \cos x)^m$ or $x^n \cos x / (a + b \sin x)^m$

9.2.7.1

1. $\int \frac{dx}{1 + \sin x} = -\tan \left(\frac{\pi}{4} - \frac{x}{2} \right)$
2. $\int \frac{dx}{1 - \sin x} = \tan \left(\frac{\pi}{4} + \frac{x}{2} \right)$
3. $\int \frac{x dx}{1 + \sin x} = -x \tan \left(\frac{\pi}{4} - \frac{x}{2} \right) + 2 \ln \left[\cos \left(\frac{\pi}{4} - \frac{x}{2} \right) \right]$
4. $\int \frac{x dx}{1 - \sin x} = x \cot \left(\frac{\pi}{4} - \frac{x}{2} \right) + 2 \ln \left[\sin \left(\frac{\pi}{4} - \frac{x}{2} \right) \right]$
5. $\int \frac{x dx}{1 + \cos x} = x \tan \frac{x}{2} + 2 \ln \left[\cos \frac{x}{2} \right]$
6. $\int \frac{x dx}{1 - \cos x} = -x \cot \frac{x}{2} + 2 \ln \left[\sin \frac{x}{2} \right]$
7. $\int \frac{x \cos x dx}{(1 + \sin x)^2} = -\frac{x}{1 + \sin x} + \tan \left(\frac{x}{2} - \frac{\pi}{4} \right)$

- $$8. \int \frac{x \cos x \, dx}{(1 - \sin x)^2} = \frac{x}{1 - \sin x} + \tan\left(\frac{x}{2} + \frac{\pi}{4}\right)$$
- $$9. \int \frac{x \sin x \, dx}{(1 + \cos x)^2} = \frac{x}{1 + \cos x} - \tan \frac{x}{2}$$
- $$10. \int \frac{x \sin x \, dx}{(1 - \cos x)^2} = -\frac{x}{1 - \cos x} - \cot \frac{x}{2}$$
- $$11. \int \frac{dx}{a + b \sin x} = \frac{2}{(a^2 - b^2)^{1/2}} \arctan \left[\frac{a \tan \frac{x}{2} + b}{(a^2 - b^2)^{1/2}} \right] \quad [a^2 > b^2]$$
- $$= \frac{1}{(b^2 - a^2)^{1/2}} \ln \left[\frac{a \tan \frac{x}{2} + b - (b^2 - a^2)^{1/2}}{a \tan \frac{x}{2} + b + (b^2 - a^2)^{1/2}} \right] \quad [a^2 < b^2]$$
- $$12. \int \frac{dx}{a + b \cos x} = \frac{2}{\sqrt{a^2 - b^2}} \arctan \frac{(a - b) \tan x/2}{\sqrt{a^2 - b^2}} \quad [a^2 > b^2]$$
- $$= \frac{1}{\sqrt{b^2 - a^2}} \ln \left| \frac{(b - a) \tan x/2 + \sqrt{b^2 - a^2}}{(b - a) \tan x/2 - \sqrt{b^2 - a^2}} \right| \quad [b^2 > a^2]$$
- $$= \frac{2}{\sqrt{b^2 - a^2}} \operatorname{atanh} \frac{(b - a) \tan x/2}{\sqrt{b^2 - a^2}} \quad [b^2 > a^2, |(b - a) \tan x/2| < \sqrt{b^2 - a^2}]$$
- $$= \frac{2}{\sqrt{b^2 - a^2}} \operatorname{arccoth} \frac{(b - a) \tan x/2}{\sqrt{b^2 - a^2}} \quad [b^2 > a^2, |(b - a) \tan x/2| > \sqrt{b^2 - a^2}]$$
- $$13. \int \frac{x^n \sin x \, dx}{(a + b \cos x)^m} = \frac{x^n}{(m - 1)b(a + b \cos x)^{m-1}} - \frac{n}{(m - 1)b} \int \frac{x^{n-1} dx}{(a + b \cos x)^{m-1}} \quad [m \neq 1]$$
- $$14. \int \frac{x^n \cos x \, dx}{(a + b \sin x)^m} = -\frac{x^n}{(m - 1)b(a + b \sin x)^{m-1}} + \frac{n}{(m - 1)b} \int \frac{x^{n-1} dx}{(a + b \sin x)^{m-1}} \quad [m \neq 1]$$

9.3 INTEGRANDS INVOLVING $\tan x$ AND/OR $\cot x$

9.3.1 Integrands Involving $\tan^n x$ or $\tan^n x / (\tan x \pm 1)$

9.3.1.1

$$1. \int \tan x \, dx = -\ln \cos x$$

$$2. \int \tan^2 x \, dx = \tan x - x$$

$$3. \int \tan^3 x \, dx = \frac{1}{2} \tan^2 x + \ln |\cos x|$$

$$4. \int \tan^4 x \, dx = \frac{1}{3} \tan^3 x - \tan x + x$$

$$5. \int \tan^{2n} x \, dx = \sum_{k=1}^n (-1)^{k-1} \frac{\tan^{2n-2k+1} x}{(2n-2k+1)} + (-1)^n x$$

$$6. \int \tan^{2n+1} x \, dx = \sum_{k=1}^n (-1)^{k-1} \frac{\tan^{2n-2k+2} x}{(2n-2k+2)} - (-1)^n \ln |\cos x|$$

$$7. \int \frac{dx}{\tan x + 1} = \int \frac{\cot x \, dx}{1 + \cot x} = \frac{1}{2}x + \frac{1}{2} \ln |\sin x + \cos x|$$

$$8. \int \frac{dx}{\tan x - 1} = \int \frac{\cot x \, dx}{1 - \cot x} = -\frac{1}{2}x + \frac{1}{2} \ln |\sin x - \cos x|$$

$$9. \int \frac{\tan x \, dx}{\tan x + 1} = \int \frac{dx}{1 + \cot x} = \frac{1}{2}x - \frac{1}{2} \ln |\sin x + \cos x|$$

$$10. \int \frac{\tan x \, dx}{\tan x - 1} = \int \frac{dx}{1 - \cot x} = \frac{1}{2}x + \frac{1}{2} \ln |\sin x - \cos x|$$

9.3.2 Integrands Involving $\cot^n x$ or $\tan x$ and $\cot x$

9.3.2.1

$$1. \int \cot x \, dx = \ln |\sin x|$$

$$2. \int \cot^2 x \, dx = -\cot x - x$$

$$3. \int \cot^3 x \, dx = -\frac{1}{2} \cot^2 x - \ln |\sin x|$$

$$4. \int \cot^4 x \, dx = -\frac{1}{3} \cot^3 x + \cot x + x$$

$$5. \int \cot^n x \, dx = -\frac{\cot^{n-1} x}{n-1} - \int \cot^{n-2} x \, dx \quad [n \neq 1]$$

$$6. \int (1 + \tan^2 x) \cot x \, dx = \ln |\tan x|$$

$$7. \int (1 + \tan^2 x) \cot^2 x \, dx = -\cot x$$

$$8. \int (1 + \tan^2 x) \cot^3 x \, dx = -\frac{1}{2} \cot^2 x$$

$$9. \int (1 + \tan^2 x) \cot^n x \, dx = -\frac{\cot^{n-1} x}{n-1}$$

9.4 INTEGRANDS INVOLVING $\sin x$ AND $\cos x$

9.4.1 Integrands Involving $\sin^m x \cos^n x$

9.4.1.1

$$1. \int \sin x \cos x \, dx = \frac{1}{2} \sin^2 x$$

$$2. \int \sin x \cos^2 x \, dx = -\frac{1}{4} \left[\frac{1}{3} \cos 3x + \cos x \right] = -\frac{1}{3} \cos^3 x$$

$$3. \int \sin x \cos^4 x \, dx = -\frac{1}{5} \cos^5 x$$

$$4. \int \sin^2 x \cos x \, dx = -\frac{1}{4} \left[\frac{1}{3} \sin 3x - \sin x \right] = \frac{1}{3} \sin^3 x$$

$$5. \int \sin^2 x \cos^2 x \, dx = -\frac{1}{8} \left[\frac{1}{4} \sin 4x - x \right]$$

$$6. \int \sin^2 x \cos^3 x \, dx = -\frac{1}{16} \left[\frac{1}{5} \sin 5x + \frac{1}{3} \sin 3x - 2 \sin x \right]$$

$$7. \int \sin^2 x \cos^4 x \, dx = \frac{1}{16} x + \frac{1}{64} \sin 2x - \frac{1}{64} \sin 4x - \frac{1}{192} \sin 6x$$

$$8. \int \sin^3 x \cos x \, dx = \frac{1}{8} \left(\frac{1}{4} \cos 4x - \cos 2x \right) = \frac{1}{4} \sin^4 x$$

$$9. \int \sin^3 x \cos^2 x \, dx = \frac{1}{16} \left(\frac{1}{5} \cos 5x - \frac{1}{3} \cos 3x - 2 \cos x \right)$$

$$10. \int \sin^3 x \cos^3 x \, dx = \frac{1}{32} \left(\frac{1}{6} \cos 6x - \frac{3}{2} \cos 2x \right)$$

9.4.2 Integrands Involving $\sin^{-n} x$

9.4.2.1

$$1. \int \frac{dx}{\sin x} = \ln \left| \tan \frac{x}{2} \right|$$

$$2. \int \frac{dx}{\sin^2 x} = -\cot x$$

3. $\int \frac{dx}{\sin^3 x} = -\frac{1}{2} \frac{\cos x}{\sin^2 x} + \frac{1}{2} \ln \left| \tan \frac{x}{2} \right|$
4. $\int \frac{dx}{\sin^4 x} = -\frac{\cos x}{3 \sin^3 x} - \frac{2}{3} \cot x$
5. $\int \frac{dx}{\sin^5 x} = -\frac{\cos x}{4 \sin^4 x} - \frac{3 \cos x}{8 \sin^2 x} + \frac{3}{8} \ln \left| \tan \frac{x}{2} \right|$

9.4.3 Integrands Involving $\cos^{-n} x$

9.4.3.1

1. $\int \frac{dx}{\cos x} = \ln \left| \tan \left(\frac{\pi}{4} + \frac{x}{2} \right) \right| = \frac{1}{2} \ln \left(\frac{1 + \sin x}{1 - \sin x} \right)$
2. $\int \frac{dx}{\cos^2 x} = \tan x$
3. $\int \frac{dx}{\cos^3 x} = \frac{1}{2} \frac{\sin x}{\cos^2 x} + \frac{1}{2} \ln \left| \tan \left(\frac{\pi}{4} + \frac{x}{2} \right) \right|$
4. $\int \frac{dx}{\cos^4 x} = \frac{\sin x}{3 \cos^3 x} + \frac{2}{3} \tan x$
5. $\int \frac{dx}{\cos^5 x} = \frac{\sin x}{4 \cos^4 x} + \frac{3 \sin x}{8 \cos^2 x} + \frac{3}{8} \ln \left| \tan \left(\frac{\pi}{4} + \frac{x}{2} \right) \right|$

9.4.4 Integrands Involving $\sin^m x / \cos^n x$ or $\cos^m x / \sin^n x$

9.4.4.1

1. $\int \frac{\sin x}{\cos x} dx = -\ln |\cos x|$
2. $\int \frac{\sin x}{\cos^2 x} dx = \frac{1}{\cos x}$
3. $\int \frac{\sin x}{\cos^3 x} dx = \frac{1}{2 \cos^2 x}$
4. $\int \frac{\sin x}{\cos^4 x} dx = \frac{1}{3 \cos^3 x}$
5. $\int \frac{\sin x}{\cos^n x} dx = \frac{1}{(n-1) \cos^{n-1} x}$
6. $\int \frac{\sin^2 x}{\cos x} dx = -\sin x + \ln \left| \tan \left(\frac{\pi}{4} + \frac{x}{2} \right) \right|$

7. $\int \frac{\sin^2 x}{\cos^2 x} dx = \tan x - x$
8. $\int \frac{\sin^2 x}{\cos^3 x} dx = \frac{\sin x}{2 \cos^2 x} - \frac{1}{2} \ln \left| \tan \left(\frac{\pi}{4} + \frac{x}{2} \right) \right|$
9. $\int \frac{\sin^2 x}{\cos^4 x} dx = \frac{1}{3} \tan^3 x$
10. $\int \frac{\sin^3 x}{\cos x} dx = -\frac{1}{2} \sin^2 x - \ln |\cos x|$
11. $\int \frac{\sin^3 x}{\cos^2 x} dx = \cos x + \frac{1}{\cos x}$
12. $\int \frac{\sin^3 x}{\cos^3 x} dx = \frac{1}{2 \cos^2 x} + \ln |\cos x|$
13. $\int \frac{\sin^3 x}{\cos^4 x} dx = -\frac{1}{\cos x} + \frac{1}{3 \cos^3 x}$
14. $\int \frac{\sin^4 x}{\cos x} dx = -\frac{1}{3} \sin^3 x - \sin x + \ln \left| \tan \left(\frac{\pi}{4} + \frac{x}{2} \right) \right|$
15. $\int \frac{\sin^4 x}{\cos^2 x} dx = \tan x + \frac{1}{2} \sin x \cos x - \frac{3}{2} x$
16. $\int \frac{\sin^4 x}{\cos^3 x} dx = \frac{\sin x}{2 \cos^2 x} + \sin x - \frac{3}{2} \ln \left| \tan \left(\frac{\pi}{4} + \frac{x}{2} \right) \right|$
17. $\int \frac{\sin^4 x}{\cos^4 x} dx = \frac{1}{3} \tan^3 x - \tan x + x$
18. $\int \frac{\cos x}{\sin x} dx = \ln |\sin x|$
19. $\int \frac{\cos x}{\sin^2 x} dx = -\frac{1}{\sin x}$
20. $\int \frac{\cos x}{\sin^3 x} dx = -\frac{1}{2 \sin^2 x}$
21. $\int \frac{\cos x}{\sin^4 x} dx = -\frac{1}{3 \sin^3 x}$
22. $\int \frac{\cos x}{\sin^n x} dx = -\frac{1}{(n-1) \sin^{n-1} x}$

23. $\int \frac{\cos^2 x}{\sin x} dx = \cos x + \ln \left| \tan \frac{x}{2} \right|$
24. $\int \frac{\cos^2 x}{\sin^2 x} dx = -\cot x - x$
25. $\int \frac{\cos^2 x}{\sin^3 x} dx = -\frac{\cos x}{2 \sin^2 x} - \frac{1}{2} \ln \left| \tan \frac{x}{2} \right|$
26. $\int \frac{\cos^2 x}{\sin^4 x} dx = -\frac{1}{3} \cot^3 x$
27. $\int \frac{\cos^3 x}{\sin x} dx = \frac{1}{2} \cos^2 x + \ln |\sin x|$
28. $\int \frac{\cos^3 x}{\sin^2 x} dx = -\sin x - \frac{1}{\sin x}$
29. $\int \frac{\cos^3 x}{\sin^3 x} dx = -\frac{1}{2 \sin^2 x} - \ln |\sin x|$
30. $\int \frac{\cos^3 x}{\sin^4 x} dx = \frac{1}{\sin x} - \frac{1}{3 \sin^3 x}$
31. $\int \frac{\cos^4 x}{\sin x} dx = \frac{1}{3} \cos^3 x + \cos x + \ln \left| \tan \frac{x}{2} \right|$
32. $\int \frac{\cos^4 x}{\sin^2 x} dx = -\cot x - \frac{1}{2} \sin x \cos x - \frac{3}{2} x$
33. $\int \frac{\cos^4 x}{\sin^3 x} dx = -\frac{\cos x}{2 \sin^2 x} - \cos x - \frac{3}{2} \ln \left| \tan \frac{x}{2} \right|$
34. $\int \frac{\cos^4 x}{\sin^4 x} dx = -\frac{1}{3} \cot^3 x + \cot x + x$

9.4.5 Integrands Involving $\sin^{-m} x \cos^{-n} x$

9.4.5.1

1. $\int \frac{dx}{\sin x \cos x} = \ln(\tan x)$
2. $\int \frac{dx}{\sin x \cos^2 x} = \frac{1}{\cos x} + \ln \left| \tan \frac{x}{2} \right|$
3. $\int \frac{dx}{\sin x \cos^3 x} = \frac{1}{2 \cos^2 x} + \ln |\tan x|$

4. $\int \frac{dx}{\sin x \cos^4 x} = \frac{1}{\cos x} + \frac{1}{3 \cos^3 x} + \ln \left| \tan \frac{x}{2} \right|$
5. $\int \frac{dx}{\sin^2 x \cos x} = \ln \left| \tan \left(\frac{\pi}{4} + \frac{x}{2} \right) \right| - \operatorname{cosec} x$
6. $\int \frac{dx}{\sin^2 x \cos^2 x} = -2 \cot 2x$
7. $\int \frac{dx}{\sin^2 x \cos^3 x} = \left(\frac{1}{2 \cos^2 x} - \frac{3}{2} \right) \frac{1}{\sin x} + \frac{3}{2} \ln \left| \tan \left(\frac{\pi}{4} + \frac{x}{2} \right) \right|$
8. $\int \frac{dx}{\sin^2 x \cos^4 x} = \frac{1}{3 \sin x \cos^3 x} - \frac{8}{3} \cot 2x$
9. $\int \frac{dx}{\sin^{2m} x \cos^{2n} x} = \sum_{k=0}^{m+n-1} \binom{m+n-1}{k} \frac{\tan^{2k-2m+1} x}{(2k-2m+1)}$
10. $\int \frac{dx}{\sin^{2m+1} x \cos^{2n+1} x} = \sum_{k=0}^{m+n} \binom{m+n}{k} \frac{\tan^{2k-2m} x}{(2k-2m)} + \binom{m+n}{m} \ln |\tan x|$

9.5 INTEGRANDS INVOLVING SINES AND COSINES WITH LINEAR ARGUMENTS AND POWERS OF x

9.5.1 Integrands Involving Products of $(ax + b)^n$, $\sin(cx + d)$, and/or $\cos(px + q)$

9.5.1.1

1. $\int \sin(ax + b) dx = -\frac{1}{a} \cos(ax + b)$
2. $\int \cos(ax + b) dx = \frac{1}{a} \sin(ax + b)$
3. $\int \sin(ax + b) \sin(cx + d) dx = \frac{\sin[(a-c)x + b-d]}{2(a-c)} - \frac{\sin[(a+c)x + b+d]}{2(a+c)} \quad [a^2 \neq c^2]$
4. $\int \sin(ax + b) \cos(cx + d) dx = -\frac{\cos[(a-c)x + b-d]}{2(a-c)} - \frac{\cos[(a+c)x + b+d]}{2(a+c)} \quad [a^2 \neq c^2]$

$$5. \int \cos(ax + b) \cos(cx + d) dx = \frac{\sin[(a - c)x + b - d]}{2(a - c)} + \frac{\sin[(a + c)x + b + d]}{2(a + c)} \quad [a^2 \neq c^2]$$

Special case $a = c$.

$$6. \int \sin(ax + b) \sin(ax + d) dx = \frac{x}{2} \cos(b - d) - \frac{\sin(2ax + b + d)}{4a}$$

$$7. \int \sin(ax + b) \cos(ax + d) dx = \frac{x}{2} \sin(b - d) - \frac{\cos(2ax + b + d)}{4a}$$

$$8. \int \cos(ax + b) \cos(ax + d) dx = \frac{x}{2} \cos(b - d) + \frac{\sin(2ax + b + d)}{4a}$$

$$9. \int (a + bx) \sin kx dx = -\frac{1}{k} (a + bx) \cos kx + \frac{b}{k^2} \sin kx$$

$$10. \int (a + bx) \cos kx dx = \frac{1}{k} (a + bx) \sin kx + \frac{b}{k^2} \cos kx$$

$$11. \int (a + bx)^2 \sin kx dx = \frac{1}{k} \left[\frac{2b^2}{k^2} - (a + bx)^2 \right] \cos kx + \frac{2b(a + bx)}{k^2} \sin kx$$

$$12. \int (a + bx)^2 \cos kx dx = \frac{1}{k} \left[(a + bx)^2 - \frac{2b^2}{k^2} \right] \sin kx + \frac{2b(a + bx)}{k^2} \cos kx$$

9.5.2 Integrands Involving $x^n \sin^m x$ or $x^n \cos^m x$

9.5.2.1

$$1. \int x \sin x dx = \sin x - x \cos x$$

$$2. \int x \cos x dx = \cos x + x \sin x$$

$$3. \int x^2 \sin x dx = 2x \sin x - (x^2 - 2) \cos x$$

$$4. \int x^2 \cos x dx = 2x \cos x + (x^2 - 2) \sin x$$

$$5. \int x^3 \sin x dx = (3x^2 - 6) \sin x - (x^3 - 6x) \cos x$$

6. $\int x^3 \cos x \, dx = (3x^2 - 6) \cos x + (x^3 - 6x) \sin x$
7. $\int x^n \sin x \, dx = -x^n \cos x + n \int x^{n-1} \cos x \, dx$
8. $\int x^n \cos x \, dx = x^n \sin x - n \int x^{n-1} \sin x \, dx$
9. $\int x \sin^2 x \, dx = \frac{1}{4}x^2 - \frac{1}{4}x \sin 2x - \frac{1}{8} \cos 2x$
10. $\int x \cos^2 x \, dx = \frac{1}{4}x^2 + \frac{1}{4}x \sin 2x + \frac{1}{8} \cos 2x$
11. $\int x^2 \sin^2 x \, dx = \frac{1}{6}x^3 - \frac{1}{4}x \cos 2x - \frac{1}{4} \left(x^2 - \frac{1}{2} \right) \sin 2x$
12. $\int x^2 \cos^2 x \, dx = \frac{1}{6}x^3 + \frac{1}{4}x \cos 2x + \frac{1}{4} \left(x^2 - \frac{1}{2} \right) \sin 2x$
13. $\int x \sin^3 x \, dx = \frac{3}{4} \sin x - \frac{1}{36} \sin 3x - \frac{3}{4}x \cos x + \frac{1}{12}x \cos 3x$
14. $\int x \cos^3 x \, dx = \frac{3}{4} \cos x + \frac{1}{36} \cos 3x + \frac{3}{4}x \sin x + \frac{1}{12}x \sin 3x$
15. $\int x^2 \sin^3 x \, dx = - \left(\frac{3}{4}x^2 - \frac{3}{2} \right) \cos x + \left(\frac{x^2}{12} - \frac{1}{54} \right) \cos 3x + \frac{3}{2}x \sin x - \frac{1}{18}x \sin 3x$
16. $\int x^2 \cos^3 x \, dx = \left(\frac{3}{4}x^2 - \frac{3}{2} \right) \sin x + \left(\frac{x^2}{12} - \frac{1}{54} \right) \sin 3x + \frac{3}{2}x \cos x + \frac{1}{18}x \cos 3x$

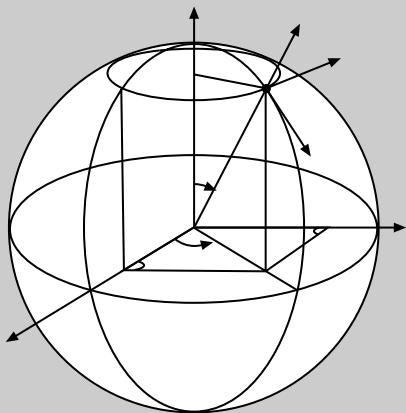

Chapter 10

Indefinite Integrals of Inverse Trigonometric Functions

10.1 INTEGRANDS INVOLVING POWERS OF x AND POWERS OF INVERSE TRIGONOMETRIC FUNCTIONS

10.1.1 Integrands Involving $x^n \arcsin^m(x/a)$

10.1.1.1

1. $\int \arcsin \frac{x}{a} dx = \arcsin \frac{x}{a} + (a^2 - x^2)^{1/2} \quad [|x/a| \leq 1]$
2. $\int \arcsin^2 \frac{x}{a} dx = x \arcsin^2 \frac{x}{a} + 2(a^2 - x^2)^{1/2} \arcsin \frac{x}{a} - 2x \quad [|x/a| \leq 1]$
3. $\int \arcsin^3 \frac{x}{a} dx = x \arcsin^3 \frac{x}{a} + 3(a^2 - x^2)^{1/2} \arcsin^2 \frac{x}{a} - 6x \arcsin \frac{x}{a} - 6(a^2 - x^2)^{1/2} \quad [|x/a| \leq 1]$
4. $\int \arcsin^n \frac{x}{a} dx = x \arcsin^n \frac{x}{a} + n(a^2 - x^2)^{1/2} \arcsin^{n-1} \frac{x}{a} - n(n-1) \int \arcsin^{n-2} \frac{x}{a} dx \quad [|x/a| \leq 1, n \neq 1]$
5. $\int x \arcsin \frac{x}{a} dx = \left(\frac{x^2}{2} - \frac{a^2}{4}\right) \arcsin \frac{x}{a} + \frac{x}{4} (a^2 - x^2)^{1/2} \quad [|x/a| \leq 1]$
6. $\int x^2 \arcsin \frac{x}{a} dx = \frac{x^3}{3} \arcsin \frac{x}{a} + \frac{1}{9} (x^2 + 2a^2) (a^2 - x^2)^{1/2} \quad [|x/a| \leq 1]$

$$7. \int x^3 \arcsin \frac{x}{a} dx = \left(\frac{x^4}{4} - \frac{3a^4}{32} \right) \arcsin \frac{x}{a} + \frac{1}{32} (2x^3 + 3a^2x) (a^2 - x^2)^{1/2} \quad [|x/a| \leq 1]$$

$$8. \int x^n \arcsin \frac{x}{a} dx = \frac{x^{n+1}}{n+1} \arcsin \frac{x}{a} - \frac{1}{n+1} \int \frac{x^{n+1} dx}{(a^2 - x^2)^{1/2}} \quad [|x/a| \leq 1]$$

10.1.2 Integrands Involving $x^{-n} \arcsin(x/a)$

10.1.2.1

$$1. \int \frac{1}{x} \arcsin \frac{x}{a} dx = \sum_{k=0}^{\infty} \frac{(2k-1)!!}{(2k)!! (2k+1)^2} \left(\frac{x}{a} \right)^{2k+1} \quad \begin{aligned} & [|x/a| < 1, (2k)!! = 2 \cdot 4 \cdot 6 \cdots (2k) \\ & (2k-1)!! = 1 \cdot 3 \cdot 5 \cdots (2k-1)] \end{aligned}$$

$$2. \int \frac{1}{x^2} \arcsin \frac{x}{a} dx = -\frac{1}{x} \arcsin \frac{x}{a} - \frac{1}{a} \ln \left| \frac{a + (a^2 - x^2)^{1/2}}{x} \right| \quad [|x/a| < 1]$$

$$3. \int \frac{1}{x^3} \arcsin \frac{x}{a} dx = -\frac{1}{2x^2} \arcsin \frac{x}{a} - \frac{(a^2 - x^2)^{1/2}}{2a^2x} \quad [|x/a| < 1]$$

$$4. \int \frac{1}{x^n} \arcsin \frac{x}{a} dx = \frac{-1}{(n-1)x^{n-1}} \arcsin \frac{x}{a} + \frac{1}{n-1} \int \frac{dx}{x^{n-1}(a^2 - x^2)^{1/2}} \quad [|x/a| < 1, n \neq 1]$$

10.1.3 Integrands Involving $x^n \arccos^m(x/a)$

10.1.3.1

$$1. \int \arccos \frac{x}{a} dx = x \arccos \frac{x}{a} - (a^2 - x^2)^{1/2} \quad [|x/a| \leq 1]$$

$$2. \int \arccos^2 \frac{x}{a} dx = x \arccos^2 \frac{x}{a} - 2(a^2 - x^2)^{1/2} \arccos \frac{x}{a} - 2x \quad [|x/a| \leq 1]$$

$$3. \int \arccos^3 \frac{x}{a} dx = x \arccos^3 \frac{x}{a} - 3(a^2 - x^2)^{1/2} \arccos^2 \frac{x}{a} - 6x \arccos \frac{x}{a} + 6(a^2 - x^2)^{1/2} \quad [|x/a| \leq 1]$$

$$4. \int \arccos^n \frac{x}{a} dx = x \arccos^n \frac{x}{a} - n(a^2 - x^2)^{1/2} \arccos^{n-1} \frac{x}{a} - n(n-1) \int \arccos^{n-2} \frac{x}{a} dx \quad [|x/a| \leq 1, n \neq 1]$$

$$5. \int x \arccos \frac{x}{a} dx = \left(\frac{x^2}{2} - \frac{a^2}{4} \right) \arccos \frac{x}{a} - \frac{x}{4} (a^2 - x^2)^{1/2} \quad [|x/a| < 1]$$

$$6. \int x^2 \arccos \frac{x}{a} dx = \frac{x^3}{3} \arccos \frac{x}{a} - \frac{1}{9} (x^2 + 2a^2) (a^2 - x^2)^{1/2} \quad [|x/a| \leq 1]$$

$$7. \int x^3 \arccos \frac{x}{a} dx = \left(\frac{x^4}{4} - \frac{3a^4}{32} \right) \arccos \frac{x}{a} - \frac{1}{32} (2x^3 + 3a^2x) (a^2 - x^2)^{1/2} \quad [|x/a| \leq 1]$$

$$8. \int x^n \arccos \frac{x}{a} dx = \frac{x^{n+1}}{n+1} \arccos \frac{x}{a} + \frac{1}{n+1} \int \frac{x^{n+1} dx}{(a^2 - x^2)^{1/2}} \quad [|x/a| \leq 1, n \neq -1]$$

10.1.4 Integrands Involving $x^{-n} \arccos(x/a)$

10.1.4.1

$$1. \int \frac{1}{x} \arccos \frac{x}{a} dx = \frac{\pi}{2} \ln|x| - \sum_{k=0}^{\infty} \frac{(2k-1)!!}{(2k)!! (2k+1)^2} \left(\frac{x}{a} \right)^{2k+1}$$

$$[|x/a| < 1, (2k)!! = 2 \cdot 4 \cdot 6 \cdots (2k), (2k-1)!! = 1 \cdot 3 \cdot 5 \cdots (2k-1)]$$

$$2. \int \frac{1}{x^2} \arccos \frac{x}{a} dx = -\frac{1}{x} \arccos \frac{x}{a} + \frac{1}{a} \ln \left| \frac{a + (a^2 - x^2)^{1/2}}{x} \right| \quad [|x/a| \leq 1]$$

$$3. \int \frac{1}{x^3} \arccos \frac{x}{a} dx = -\frac{1}{2x^2} \arccos \frac{x}{a} + \frac{(a^2 - x^2)^{1/2}}{2a^2x} \quad [|x/a| \leq 1]$$

$$4. \int \frac{1}{x^n} \arccos \frac{x}{a} dx = \frac{-1}{(n-1)x^{n-1}} \arccos \frac{x}{a} - \frac{1}{n-1} \int \frac{dx}{x^{n-1} (a^2 - x^2)^{1/2}}$$

$$[|x/a| \leq 1, n \neq 1]$$

10.1.5 Integrands Involving $x^n \arctan(x/a)$

10.1.5.1

$$1. \int \arctan \frac{x}{a} dx = x \arctan \frac{x}{a} - \frac{a}{2} \ln(x^2 + a^2)$$

$$2. \int x \arctan \frac{x}{a} dx = \frac{1}{2} (x^2 + a^2) \arctan \frac{x}{a} - \frac{1}{2} ax$$

$$3. \int x^2 \arctan \frac{x}{a} dx = \frac{1}{3} x^3 \arctan \frac{x}{a} - \frac{1}{6} ax^2 + \frac{1}{6} a^3 \ln(x^2 + a^2)$$

$$4. \int x^3 \arctan \frac{x}{a} dx = \frac{1}{4} (x^4 - a^4) \arctan \frac{x}{a} - \frac{1}{12} ax^3 + \frac{1}{4} a^3 x$$

$$5. \int x^n \arctan \frac{x}{a} dx = \frac{x^{n+1}}{n+1} \arctan \frac{x}{a} - \frac{a}{n+1} \int \frac{x^{n+1} dx}{x^2 + a^2}$$

10.1.6 Integrands Involving $x^{-n} \arctan(x/a)$

10.1.6.1

$$1. \int \frac{1}{x} \arctan \frac{x}{a} dx = \sum_{k=0}^{\infty} \frac{(-1)^k}{(2k+1)^2} \left(\frac{x}{a} \right)^{2k+1} \quad [|x/a| < 1]$$

$$\begin{aligned}
 &= \frac{\pi}{2} \ln|x| + \sum_{k=0}^{\infty} \frac{(-1)^k}{(2k+1)^2} \left(\frac{a}{x}\right)^{2k+1} && [x/a > 1] \\
 &= -\frac{\pi}{2} \ln|x| + \sum_{k=0}^{\infty} \frac{(-1)^k}{(2k+1)^2} \left(\frac{a}{x}\right)^{2k+1} && [x/a < -1]
 \end{aligned}$$

2. $\int \frac{1}{x^2} \arctan \frac{x}{a} dx = -\frac{1}{x} \arctan \frac{x}{a} + \frac{1}{2a} \ln\left(\frac{x^2}{x^2+a^2}\right)$
3. $\int \frac{1}{x^3} \arctan \frac{x}{a} dx = -\frac{1}{2} \left(\frac{1}{x^2} + \frac{1}{a^2}\right) \arctan \frac{x}{a} - \frac{1}{2ax}$
4. $\int \frac{1}{x^n} \arctan \frac{x}{a} dx = -\frac{1}{(n-1)x^{n-1}} \arctan \frac{x}{a} + \frac{a}{n-1} \int \frac{dx}{x^{n-1}(x^2+a^2)}$ $[n \neq 1]$

10.1.7 Integrands Involving $x^n \operatorname{arccot}(x/a)$

10.1.7.1

1. $\int \operatorname{arccot} \frac{x}{a} dx = x \operatorname{arccot} \frac{x}{a} + \frac{1}{2}a \ln(x^2+a^2)$
2. $\int x \operatorname{arccot} \frac{x}{a} dx = \frac{1}{2}(x^2+a^2) \operatorname{arccot} \frac{x}{a} + \frac{1}{2}ax$
3. $\int x^2 \operatorname{arccot} \frac{x}{a} dx = \frac{1}{3}x^3 \operatorname{arccot} \frac{x}{a} + \frac{1}{6}ax^2 - \frac{1}{6}a^3 \ln(x^2+a^2)$
4. $\int x^3 \operatorname{arccot} \frac{x}{a} dx = \frac{1}{4}(x^4-a^4) \operatorname{arccot} \frac{x}{a} + \frac{1}{12}ax^3 - \frac{1}{4}a^3x$
5. $\int x^n \operatorname{arccot} \frac{x}{a} dx = \frac{x^{n+1}}{n+1} \operatorname{arccot} \frac{x}{a} + \frac{a}{n+1} \int \frac{x^{n+1} dx}{x^2+a^2}$

10.1.8 Integrands Involving $x^{-n} \operatorname{arccot}(x/a)$

10.1.8.1

1. $\int \frac{1}{x} \operatorname{arccot} \frac{x}{a} dx = \frac{\pi}{2} \ln|x| - \sum_{k=0}^{\infty} \frac{(-1)^k}{(2k+1)^2} \left(\frac{x}{a}\right)^{2k+1}$ $[|x/a| < 1]$
 $= -\sum_{k=0}^{\infty} \frac{(-1)^k}{(2k+1)^2} \left(\frac{a}{x}\right)^{2k+1}$ $[x/a > 1]$
 $= \pi \ln|x| - \sum_{k=0}^{\infty} \frac{(-1)^k}{(2k+1)^2} \left(\frac{a}{x}\right)^{2k+1}$ $[x/a < -1]$
2. $\int \frac{1}{x^2} \operatorname{arccot} \frac{x}{a} dx = -\frac{1}{x} \operatorname{arccot} \frac{x}{a} - \frac{1}{2a} \ln\left(\frac{x^2}{x^2+a^2}\right)$
3. $\int \frac{1}{x^3} \operatorname{arccot} \frac{x}{a} dx = -\frac{1}{2} \left(\frac{1}{x^2} + \frac{1}{a^2}\right) \operatorname{arccot} \frac{x}{a} + \frac{1}{2ax}$

$$4. \int \frac{1}{x^n} \operatorname{arccot} \frac{x}{a} dx = \frac{-1}{(n-1)x^{n-1}} \operatorname{arccot} \frac{x}{a} - \frac{a}{n-1} \int \frac{dx}{x^{n-1}(x^2+a^2)} \quad [n \neq 1]$$

10.1.9 Integrands Involving Products of Rational Functions and $\operatorname{arccot}(x/a)$

10.1.9.1

1. $\int \frac{1}{(x^2+a^2)} \operatorname{arccot} \frac{x}{a} dx = -\frac{1}{2a} \operatorname{arccot}^2 \frac{x}{a}$
2. $\int \left(\frac{x^2}{x^2+a^2} \right) \operatorname{arccot} \frac{x}{a} dx = x \operatorname{arccot} \frac{x}{a} + \frac{1}{2}a \ln(x^2+a^2) + \frac{1}{2}a \operatorname{arccot}^2 \frac{x}{a}$
3. $\int \frac{1}{(x^2+a^2)^2} \operatorname{arccot} \frac{x}{a} dx = \frac{x}{2a^2(x^2+a^2)} \operatorname{arccot} \frac{x}{a} - \frac{1}{4a^3} \operatorname{arccot}^2 \frac{x}{a} - \frac{1}{4a(x^2+a^2)}$
4. $\int \frac{1}{(x^2+a^2)} \operatorname{arccot}^n \frac{x}{a} dx = -\frac{1}{(n+1)a} \operatorname{arccot}^{n+1} \left(\frac{x}{a} \right)$

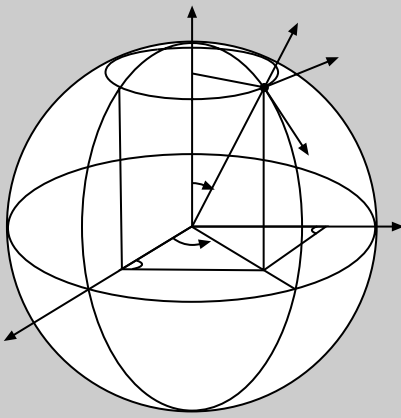

Chapter 11

The Gamma, Beta, Pi, and Psi Functions, and the Incomplete Gamma Functions

11.1 THE EULER INTEGRAL. LIMIT AND INFINITE PRODUCT REPRESENTATIONS FOR THE GAMMA FUNCTION $\Gamma(x)$. THE INCOMPLETE GAMMA FUNCTIONS $\Gamma(\alpha, x)$ AND $\gamma(\alpha, x)$

11.1.1 Definitions and Notation

11.1.1.1

The **gamma function**, denoted by $\Gamma(x)$, provides a generalization of factorial n to the case in which n is not an integer. It is defined by the **Euler integral**:

$$1. \quad \Gamma(x) = \int_0^{\infty} t^{x-1} e^{-t} dt = \int_0^1 [\ln(1/t)]^{x-1} dt.$$

and for the integral values of x has the property that

$$2. \quad \Gamma(n+1) = 1 \cdot 2 \cdot 3 \cdots (n-1)n = n!$$

and, in particular,

$$3. \quad \Gamma(1) = \Gamma(2) = 1.$$

A related notation defines the **pi function** $\Pi(x)$ as

$$4. \quad \Pi(x) = \Gamma(x+1) = \int_0^{\infty} t^x e^{-t} dt.$$

It follows from this that when n is an integer

$$5. \quad \Pi(n) = n! \quad \text{and} \quad \Pi(n) = n\Pi(n-1).$$

Alternative definitions of the gamma function are the Euler definition in terms of a limit

$$6. \quad \Gamma(x) = \lim_{n \rightarrow \infty} \frac{n!n^x}{x(x+1)\cdots(x+n)} \quad [n \neq 0, -1, -2, \dots]$$

and the Weierstrass infinite product representation

$$7. \quad \frac{1}{\Gamma(x)} = xe^{\gamma x} \prod_{n=1}^{\infty} \left[\left(1 + \frac{x}{n}\right) e^{-x/n} \right],$$

where γ is **Euler's constant** (also known as the **Euler–Mascheroni constant**) defined as

$$\gamma = \lim_{n \rightarrow \infty} \left(1 + \frac{1}{2} + \frac{1}{3} + \cdots + \frac{1}{n} - \ln n \right) = 0.57721566 \dots$$

The symbol C is also used to denote this constant instead of γ .

11.1.2 Special Properties of $\Gamma(x)$

11.1.2.1

The two most important recurrence formulas involving the gamma function are

1. $\Gamma(x+1) = x\Gamma(x)$
2. $\Gamma(x+n) = (x+n-1)(x+n-2)\cdots(x+1)\Gamma(x+1)$.

The **reflection formula** for the gamma function is

$$3. \quad \Gamma(x)\Gamma(1-x) = -x\Gamma(-x)\Gamma(x) = \pi \operatorname{cosec} \pi x$$

$$4. \quad \Gamma(x)\Gamma(-x) = -\frac{\pi}{x \sin \pi x}$$

$$5. \quad \Gamma\left(\frac{1}{2} + x\right)\Gamma\left(\frac{1}{2} - x\right) = \frac{\pi}{\cos \pi x}.$$

6. A result involving $\Gamma(2n)$ is

$$\Gamma(2n) = \pi^{-1/2} 2^{2n-1} \Gamma(n)\Gamma\left(n + \frac{1}{2}\right).$$

When working with series it is sometimes useful to express the binomial coefficient $\binom{n}{m}$ in terms of the gamma function by using the result

$$7. \quad \binom{n}{m} = \frac{n!}{m!(n-m)!} = \frac{\Gamma(n+1)}{\Gamma(m+1)\Gamma(n-m+1)}.$$

11.1.3 Asymptotic Representations of $\Gamma(x)$ and $n!$

11.1.3.1

The **Stirling formulas** that yield asymptotic approximations to $\Gamma(x)$ and $n!$ for large values of x and n , respectively, are

$$1. \quad \Gamma(x) \sim e^{-x} x^{x-(1/2)} (2\pi)^{1/2} \left(1 + \frac{1}{12x} + \frac{1}{288x^2} - \frac{139}{51840x^3} - \dots \right) \quad [x \gg 0]$$

$$2. \quad n! \sim (2\pi)^{1/2} n^{n+(1/2)} e^{-n} \quad [n \gg 0].$$

Two other useful asymptotic results are

$$3. \quad \Gamma(ax+b) \sim (2\pi)^{1/2} e^{-ax} (ax)^{ax+b-(1/2)} \quad [x \gg 0, a > 0]$$

$$4. \quad \ln \Gamma(x) \sim \left(x - \frac{1}{2}\right) \ln x - x + \frac{1}{2} \ln(2\pi) + \sum_{n=1}^{\infty} \frac{B_{2n}}{2n(2n-1)x^{2n-1}} \quad [x \gg 0].$$

11.1.4 Special Values of $\Gamma(x)$

11.1.4.1

$$1. \quad \Gamma(1/4) = 3.62560990 \dots$$

$$2. \quad \Gamma(1/2) = \pi^{1/2} = 1.77245385 \dots$$

$$3. \quad \Gamma(3/4) = 1.22541670 \dots$$

$$4. \quad \Gamma(3/2) = \frac{1}{2}\pi^{1/2} = 0.88622692 \dots$$

$$5. \quad \Gamma\left(n + \frac{1}{4}\right) = \frac{1 \cdot 5 \cdot 9 \cdot 13 \cdots (4n-3)}{4^n} \Gamma(1/4)$$

$$6. \quad \Gamma\left(n + \frac{1}{2}\right) = \frac{1 \cdot 3 \cdot 5 \cdot 7 \cdots (2n-1)}{2^n} \Gamma(1/2)$$

$$7. \quad \Gamma\left(n + \frac{3}{4}\right) = \frac{3 \cdot 7 \cdot 11 \cdot 15 \cdots (4n-1)}{4^n} \Gamma(3/4)$$

$$8. \quad \Gamma\left(\frac{1}{2}\right) \Gamma\left(-\frac{1}{2}\right) = -2\pi$$

11.1.5 The Gamma Function in the Complex Plane

11.1.5.1

For complex $z = x + iy$, the gamma function is defined as

$$1. \quad \Gamma(z) = \int_0^{\infty} t^{z-1} e^{-t} dt \quad [\operatorname{Re}\{z\} > 0].$$

The following properties hold for $\Gamma(z)$:

2. $\Gamma(\bar{z}) = \overline{\Gamma(z)}$
3. $\ln \Gamma(\bar{z}) = \overline{\ln \Gamma(z)}$
4. $\arg \Gamma(z+1) = \arg \Gamma(z) + \arctan \frac{y}{x}$
5. $|\Gamma(z)| \leq |\Gamma(x)|$

11.1.6 The Psi (Digamma) Function

11.1.6.1

The **psi function**, written $\psi(z)$ and also called the **digamma function**, is defined as

1. $\psi(z) = \frac{d}{dz} [\ln \Gamma(z)] = \Gamma'(z)/\Gamma(z).$

The psi function has the following properties:

2. $\psi(z+1) = \psi(z) + \frac{1}{z}$ (recurrence formula)
3. $\psi(1-z) = \psi(z) + \pi \cot \pi z$ (reflection formula)
4. $\psi(\bar{z}) = \overline{\psi(z)}$
5. $\psi(1) = -\gamma$
6. $\psi(n) = -\gamma + \sum_{k=1}^{n-1} 1/k \quad [n \geq 2]$
7. $\psi\left(\frac{1}{2}\right) = -\gamma - 2 \ln 2 = -1.96351002 \dots$
8. $\psi\left(n + \frac{1}{2}\right) = -\gamma - 2 \ln 2 + 2 \left(1 + \frac{1}{3} + \frac{1}{5} + \dots + \frac{1}{2n-1}\right) \quad [n \geq 1]$
9. $\psi(z+n) = \frac{1}{(n-1)+z} + \frac{1}{(n-2)+z} + \dots + \frac{1}{2+z} + \frac{1}{1+z} + \psi(z+1)$
10. $\psi(x) = \sum_{n=1}^{\infty} \left(\frac{1}{n} - \frac{1}{x-1+n}\right) - \gamma$
11. $\psi(z) \sim \ln z - \frac{1}{2z} - \sum_{n=1}^{\infty} \frac{B_{2n}}{2n z^{2n}} \quad [z \rightarrow \infty \text{ in } |\arg z| < \pi]$

Care must be exercised when using the psi function in conjunction with other reference sources because on occasions, instead of the definition used in 11.1.6.1.1, $\psi(z)$ is defined as $d[\ln \Gamma(z+1)]/dz$.

11.1.7 The Beta Function

11.1.7.1

The **beta function**, denoted by $B(x, y)$, is defined as

$$1. \quad B(x, y) = \int_0^1 t^{x-1} (1-t)^{y-1} dt = \int_0^\infty \frac{t^{x-1}}{(1+t)^{x+y}} dt \quad [x > 0, y > 0].$$

$B(x, y)$ has the following properties:

$$2. \quad B(x, y) = \frac{\Gamma(x)\Gamma(y)}{\Gamma(x+y)} \quad [x > 0, y > 0]$$

$$3. \quad B(x, y) = B(y, x) \quad (\text{symmetry})$$

$$4. \quad B(m, n) = \frac{(m-1)!(n-1)!}{(m+n-1)!} \quad (m, n \text{ nonnegative integers})$$

$$5. \quad B(x, y)B(x+y, w) = B(y, w)B(y+w, x)$$

$$6. \quad \frac{1}{B(m, n)} = m \binom{n+m-1}{n-1} = n \binom{n+m-1}{m-1} \quad [m, n = 1, 2, \dots]$$

11.1.8 Graph of $\Gamma(x)$ and Tabular Values of $\Gamma(x)$ and $\ln \Gamma(x)$

11.1.8.1

Figure 11.1 shows the behavior of $\Gamma(x)$ for $-4 < x < 4$. The gamma function becomes infinite at $x = 0, -1, -2, \dots$

Table 11.1 lists numerical values of $\Gamma(x)$ and $\ln \Gamma(x)$ for $0 \leq x \leq 2$. If required, the table may be extended by using these results:

- $\Gamma(x+1) = x\Gamma(x)$,
- $\ln \Gamma(x+1) = \ln x + \ln \Gamma(x)$.

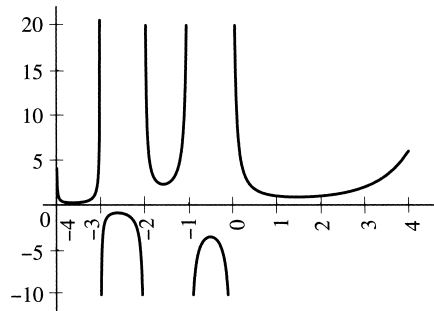

Figure 11.1. Graph of $\Gamma(x)$ for $-4 < x < 4$.

11.1.9 The Incomplete Gamma Function

The incomplete **gamma function** takes the two forms

$$1. \quad \gamma(\alpha, x) = \int_0^x t^{\alpha-1} e^{-t} dt \quad [\operatorname{Re} \alpha > 0]$$

$$2. \quad \Gamma(\alpha, x) = \int_x^\infty t^{\alpha-1} e^{-t} dt \quad [\operatorname{Re} \alpha > 0],$$

where these two forms of the function are related to the gamma function $\Gamma(\alpha)$ by the result

$$3. \quad \Gamma(\alpha) = \gamma(\alpha, x) + \Gamma(\alpha, x).$$

Special cases

$$4. \quad \gamma(1+n, x) = n! \left[1 - e^{-x} \left(\sum_{m=0}^n \frac{x^m}{m!} \right) \right] \quad [n = 0, 1, \dots]$$

$$5. \quad \Gamma(n+1, x) = n! e^{-x} \sum_{m=0}^n \frac{x^m}{m!} \quad [n = 0, 1, \dots]$$

$$6. \quad \Gamma(-n, x) = \frac{(-1)^n}{n!} \left[\operatorname{Ei}(-x) - e^{-x} \sum_{m=0}^{n-1} (-1)^m \frac{m!}{x^{m+1}} \right] \quad [n = 1, 2, \dots]$$

Series representations

$$7. \quad \gamma(\alpha, x) = \sum_{n=0}^{\infty} \frac{(-1)^n x^{\alpha+n}}{n!(\alpha+n)} \quad [\alpha \neq 0, -1, -2, \dots]$$

$$8. \quad \Gamma(\alpha, x) = \Gamma(\alpha) - \sum_{n=0}^{\infty} \frac{(-1)^n x^{\alpha+n}}{n!(\alpha+n)} \quad [\alpha \neq 0, -1, -2, \dots]$$

Functional relations

$$9. \quad \frac{\Gamma(\alpha+n, x)}{\Gamma(\alpha+n)} = \frac{\Gamma(\alpha, x)}{\Gamma(\alpha)} + e^{-x} \sum_{s=0}^{n-1} \frac{x^{\alpha+s}}{\Gamma(\alpha+s+1)}$$

$$10. \quad \Gamma(\alpha)\Gamma(\alpha+n, x) - \Gamma(\alpha+n)\Gamma(\alpha, x) = \Gamma(\alpha+n)\gamma(\alpha, x) - \Gamma(\alpha)\Gamma(\alpha+n, x)$$

Definite integrals

$$11. \quad \int_0^\infty \exp(-\beta x^n \pm \alpha) dx = \frac{e^{\pm\alpha}}{n\beta^{1/n}} \Gamma(1/n) \quad [\beta > 0, n > 0]$$

$$12. \quad \int_0^u \exp(-\beta x^n \pm \alpha) dx = \frac{e^{\pm\alpha}}{n\beta^{1/n}} \gamma(1/n, \beta u^n) \quad [\beta > 0, n > 0]$$

13. $\int_u^\infty \exp(-\beta x^n \pm \alpha) dx = \frac{e^{\pm\alpha}}{n\beta^{1/n}} \Gamma(1/n, \beta u^n) \quad [\beta > 0, n > 0]$
14. $\int_0^\infty \frac{\exp(-\beta x^n)}{x^m} dx = \frac{\Gamma(z)}{n\beta^z}, \quad \text{with } z = (1 - m)/n > 0 \quad [\beta > 0, n > 0]$
15. $\int_0^u \frac{\exp(-\beta x^n)}{x^m} dx = \frac{\gamma(z, \beta u^n)}{n\beta^z}, \quad \text{with } z = (1 - m)/n > 0 \quad [\beta > 0, n > 0]$
16. $\int_u^\infty \frac{\exp(-\beta x^n)}{x^m} dx = \frac{\Gamma(z, \beta u^n)}{n\beta^z}, \quad \text{with } z = (1 - m)/n > 0 \quad [\beta > 0, n > 0]$

Table 11.1. Tables of $\Gamma(x)$ and $\ln \Gamma(x)$

x	$\Gamma(x)$	$\ln \Gamma(x)$	x	$\Gamma(x)$	$\ln \Gamma(x)$
0	∞	∞	0.46	1.925227	0.655044
0.01	99.432585	4.599480	0.47	1.884326	0.633570
0.02	49.442210	3.900805	0.48	1.845306	0.612645
0.03	32.784998	3.489971	0.49	1.808051	0.592250
0.04	24.460955	3.197078	0.50	1.772454	0.572365
0.05	19.470085	2.968879	0.51	1.738415	0.552974
0.06	16.145727	2.781655	0.52	1.705844	0.534060
0.07	13.773601	2.622754	0.53	1.674656	0.515608
0.08	11.996566	2.484620	0.54	1.644773	0.497603
0.09	10.616217	2.362383	0.55	1.616124	0.480031
0.10	9.513508	2.252713	0.56	1.588641	0.462879
0.11	8.612686	2.153236	0.57	1.562263	0.446135
0.12	7.863252	2.062200	0.58	1.536930	0.429787
0.13	7.230242	1.978272	0.59	1.512590	0.413824
0.14	6.688686	1.900417	0.60	1.489192	0.398234
0.15	6.220273	1.827814	0.61	1.466690	0.383008
0.16	5.811269	1.759799	0.62	1.445038	0.368136
0.17	5.451174	1.695831	0.63	1.424197	0.353608
0.18	5.131821	1.635461	0.64	1.404128	0.339417
0.19	4.846763	1.578311	0.65	1.384795	0.325552

(Continues)

Table 11.1. (*Continued*)

x	$\Gamma(x)$	$\ln \Gamma(x)$	x	$\Gamma(x)$	$\ln \Gamma(x)$
0.20	4.590844	1.524064	0.66	1.366164	0.312007
0.21	4.359888	1.472446	0.67	1.348204	0.298773
0.22	4.150482	1.423224	0.68	1.330884	0.285843
0.23	3.959804	1.376194	0.69	1.314177	0.273210
0.24	3.785504	1.331179	0.70	1.298055	0.260867
0.25	3.625610	1.288023	0.71	1.282495	0.248808
0.26	3.478450	1.246587	0.72	1.267473	0.237025
0.27	3.342604	1.206750	0.73	1.252966	0.225514
0.28	3.216852	1.168403	0.74	1.238954	0.214268
0.29	3.100143	1.131448	0.75	1.225417	0.203281
0.30	2.991569	1.095798	0.76	1.212335	0.192549
0.31	2.890336	1.061373	0.77	1.199692	0.182065
0.32	2.795751	1.028101	0.78	1.187471	0.171826
0.33	2.707206	0.995917	0.79	1.175655	0.161825
0.34	2.624163	0.964762	0.80	1.164230	0.152060
0.35	2.546147	0.934581	0.81	1.153181	0.142524
0.36	2.472735	0.905325	0.82	1.142494	0.133214
0.37	2.403550	0.876947	0.83	1.132157	0.124125
0.38	2.338256	0.849405	0.84	1.122158	0.115253
0.39	2.276549	0.822661	0.85	1.112484	0.106595
0.40	2.218160	0.796678	0.86	1.103124	0.098147
0.41	2.162841	0.771422	0.87	1.094069	0.089904
0.42	2.110371	0.746864	0.88	1.085308	0.081864
0.43	2.060549	0.722973	0.89	1.076831	0.074022
0.44	2.013193	0.699722	0.90	1.068629	0.066376
0.45	1.968136	0.677087	0.91	1.060693	0.058923
0.92	1.053016	0.051658	1.37	0.889314	-0.117305
0.93	1.045588	0.044579	1.38	0.888537	-0.118179

(Continues)

Table 11.1. (*Continued*)

x	$\Gamma(x)$	$\ln \Gamma(x)$	x	$\Gamma(x)$	$\ln \Gamma(x)$
0.94	1.038403	0.037684	1.39	0.887854	-0.118948
0.95	1.031453	0.030969	1.40	0.887264	-0.119613
0.96	1.024732	0.024431	1.41	0.886765	-0.120176
0.97	1.018232	0.018068	1.42	0.886356	-0.120637
0.98	1.011947	0.011877	1.43	0.886036	-0.120997
0.99	1.005872	0.005855	1.44	0.885805	-0.121258
1	1	0	1.45	0.885661	-0.121421
1.01	0.994326	-0.005690	1.46	0.885604	-0.121485
1.02	0.988844	-0.011218	1.47	0.885633	-0.121452
1.03	0.983550	-0.016587	1.48	0.885747	-0.121324
1.04	0.978438	-0.021798	1.49	0.885945	-0.121100
1.05	0.973504	-0.026853	1.50	0.886227	-0.120782
1.06	0.968744	-0.031755	1.51	0.886592	-0.120371
1.07	0.964152	-0.036506	1.52	0.887039	-0.119867
1.08	0.959725	-0.041108	1.53	0.887568	-0.119271
1.09	0.955459	-0.045563	1.54	0.888178	-0.118583
1.10	0.951351	-0.049872	1.55	0.888868	-0.117806
1.11	0.947396	-0.054039	1.56	0.889639	-0.116939
1.12	0.943590	-0.058063	1.57	0.890490	-0.115984
1.13	0.939931	-0.061948	1.58	0.891420	-0.114940
1.14	0.936416	-0.065695	1.59	0.892428	-0.113809
1.15	0.933041	-0.069306	1.60	0.893515	-0.112592
1.16	0.929803	-0.072782	1.61	0.894681	-0.111288
1.17	0.926700	-0.076126	1.62	0.895924	-0.109900
1.18	0.923728	-0.079338	1.63	0.897244	-0.108427
1.19	0.920885	-0.082420	1.64	0.898642	-0.106871
1.20	0.918169	-0.085374	1.65	0.900117	-0.105231
1.21	0.915576	-0.088201	1.66	0.901668	-0.103508

(Continues)

Table 11.1. (*Continued*)

x	$\Gamma(x)$	$\ln \Gamma(x)$	x	$\Gamma(x)$	$\ln \Gamma(x)$
1.22	0.913106	-0.090903	1.67	0.903296	-0.101704
1.23	0.910755	-0.093482	1.68	0.905001	-0.099819
1.24	0.908521	-0.095937	1.69	0.906782	-0.097853
1.25	0.906402	-0.098272	1.70	0.908639	-0.095808
1.26	0.904397	-0.100487	1.71	0.910572	-0.093683
1.27	0.902503	-0.102583	1.72	0.912581	-0.091479
1.28	0.900718	-0.104563	1.73	0.914665	-0.089197
1.29	0.899042	-0.106426	1.74	0.916826	-0.086838
1.30	0.897471	-0.108175	1.75	0.919063	-0.084401
1.31	0.896004	-0.109810	1.76	0.921375	-0.081888
1.32	0.894640	-0.111333	1.77	0.923763	-0.079300
1.33	0.893378	-0.112745	1.78	0.926227	-0.076636
1.34	0.892216	-0.114048	1.79	0.928767	-0.073897
1.35	0.891151	-0.115241	1.80	0.931384	-0.071084
1.36	0.890185	-0.116326	1.81	0.934076	-0.068197
1.82	0.936845	-0.065237	1.91	0.965231	-0.035388
1.83	0.939690	-0.062205	1.92	0.968774	-0.031724
1.84	0.942612	-0.059100	1.93	0.972397	-0.027991
1.85	0.945611	-0.055924	1.94	0.976099	-0.024191
1.86	0.948687	-0.052676	1.95	0.979881	-0.020324
1.87	0.951840	-0.049358	1.96	0.983743	-0.016391
1.88	0.955071	-0.045970	1.97	0.987685	-0.012391
1.89	0.958379	-0.042512	1.98	0.991708	-0.008326
1.90	0.961766	-0.038984	1.99	0.995813	-0.004196
			2	1	0

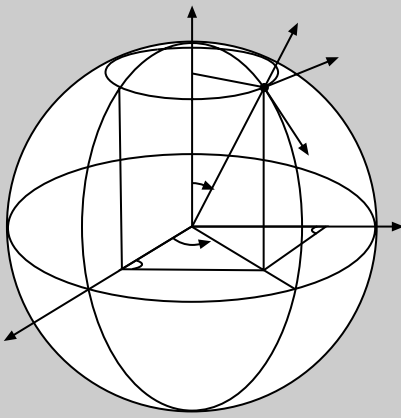

Chapter 12

Elliptic Integrals and Functions

12.1 ELLIPTIC INTEGRALS

12.1.1 Legendre Normal Forms

12.1.1.1

An **elliptic integral** is an integral of the form $\int R(x, \sqrt{P(x)})dx$, in which R is a rational function of its arguments and $P(x)$ is a third- or fourth-degree polynomial with distinct zeros. Every elliptic integral can be reduced to a sum of integrals expressible in terms of algebraic, trigonometric, inverse trigonometric, logarithmic, and exponential functions (the **elementary functions**), together with one or more of the following three special types of integral:

Elliptic integral of the first kind.

$$1. \int \frac{dx}{\sqrt{(1-x^2)(1-k^2x^2)}} \quad [k^2 < 1]$$

Elliptic integral of the second kind.

$$2. \int \frac{\sqrt{1-k^2x^2}}{\sqrt{1-x^2}} dx \quad [k^2 < 1]$$

Elliptic integral of the third kind.

$$3. \int \frac{dx}{(1-nx^2)\sqrt{(1-x^2)(1-k^2x^2)}} \quad [k^2 < 1]$$

These integrals are said to be expressed in the **Legendre normal form**. The number k is called the **modulus** of the elliptic integral, and the number $k' = \sqrt{1 - k^2}$ is called the **complementary modulus** of the elliptic integral. It is usual to set $k = \sin \alpha$, to call α the **modular angle**, and $m = k^2 = \sin^2 \alpha$ the **parameter**. In 12.1.1.1.3, the number n is called the **characteristic parameter** of the elliptic integral of the third kind.

For many purposes it is more convenient to work with the trigonometric forms of these integrals. These are obtained by setting $x = \sin \theta$, and then regarding the integrals as functions of their upper limits by evaluating them over the interval $[0, \varphi]$, thereby defining the **elliptic functions**, or **incomplete elliptic integrals**, $F(\varphi, k)$, $E(\varphi, k)$, and $\Pi(\varphi, k)$ as follows:

Incomplete elliptic integral of the first kind.

$$4. \quad F(\varphi, k) = \int_0^\varphi \frac{d\theta}{(1 - k^2 \sin^2 \theta)^{1/2}} = \int_0^{\sin \varphi} \frac{dx}{\sqrt{(1 - x^2)(1 - k^2 x^2)}}$$

Incomplete elliptic integral of the second kind.

$$5. \quad E(\varphi, k) = \int_0^\varphi (1 - k^2 \sin^2 \theta)^{1/2} d\theta = \int_0^{\sin \varphi} \frac{\sqrt{1 - k^2 x^2}}{\sqrt{1 - k^2}} dx \quad [k^2 < 1]$$

Incomplete elliptic integral of the third kind.

$$6. \quad \Pi(\varphi, n, k) = \int_0^\varphi \frac{d\theta}{(1 - n \sin^2 \theta)(1 - k^2 \sin^2 \theta)^{1/2}} \\ = \int_0^{\sin \varphi} \frac{dx}{(1 - nx^2)\sqrt{(1 - x^2)(1 - k^2 x^2)}} \quad [k^2 < 1]$$

When the integration in 12.1.1.1.4-5 is extended over the interval $0 \leq \theta \leq \pi/2$, the integrals are called **complete elliptic integrals**. The notation used for complete elliptic integrals is

$$7. \quad \mathbf{K}(k) = F\left(\frac{\pi}{2}, k\right) = \mathbf{K}'(k')$$

$$8. \quad \mathbf{E}(k) = E\left(\frac{\pi}{2}, k\right) = \mathbf{E}'(k')$$

$$9. \quad \mathbf{K}'(k) = F\left(\frac{\pi}{2}, k'\right) = \mathbf{K}(k')$$

$$10. \quad \mathbf{E}'(k) = E\left(\frac{\pi}{2}, k'\right) = \mathbf{E}(k')$$

Frequently the modulus k is omitted from this notation with the understanding that

$$\mathbf{K} \equiv \mathbf{K}(k), \quad \mathbf{K}' \equiv \mathbf{K}'(k), \quad \mathbf{E} = \mathbf{E}(k), \quad \mathbf{E}' = \mathbf{E}'(k).$$

12.1.2 Tabulations and Trigonometric Series Representations of Complete Elliptic Integrals

Abbreviated tabulations of complete elliptic integrals of the first and second kinds are given in Tables 12.1 and 12.2, with the respective arguments k^2 and the modular angle $\alpha(k = \sin \alpha)$.

Table 12.1. Short Table of Complete Elliptic Integrals of the First and Second Kinds with Argument k^2

$$\mathbf{K}(k) = \int_0^{\pi/2} (1 - k^2 \sin^2 t)^{-1/2} dt \quad \mathbf{K}'(k) = \int_0^{\pi/2} [1 - (1 - k^2) \sin^2 t]^{-1/2} dt$$

$$\mathbf{E}(k) = \int_0^{\pi/2} (1 - k^2 \sin^2 t)^{1/2} dt \quad \mathbf{E}'(k) = \int_0^{\pi/2} [1 - (1 - k^2) \sin^2 t]^{1/2} dt$$

k^2	$\mathbf{K}(k)$	$\mathbf{K}'(k)$	$\mathbf{E}(k)$	$\mathbf{E}'(k)$
0	1.570796	∞	1.570796	1
0.05	1.591003	2.908337	1.550973	1.060474
0.1	1.612441	2.578092	1.530758	1.104775
0.15	1.635257	2.389016	1.510122	1.143396
0.2	1.659624	2.257205	1.489035	1.17849
0.25	1.68575	2.156516	1.467462	1.211056
0.3	1.713889	2.075363	1.445363	1.241671
0.35	1.744351	2.007598	1.422691	1.270707
0.4	1.777519	1.949568	1.399392	1.298428
0.45	1.813884	1.898925	1.375402	1.325024
0.5	1.854075	1.854075	1.350644	1.350644
0.55	1.898925	1.813884	1.325024	1.375402
0.6	1.949568	1.777519	1.298428	1.399392
0.65	2.007598	1.744351	1.270707	1.422691
0.7	2.075363	1.713889	1.241671	1.445363
0.75	2.156516	1.68575	1.211056	1.467462
0.8	2.257205	1.659624	1.17849	1.489035
0.85	2.389016	1.635257	1.143396	1.510122
0.9	2.578092	1.612441	1.104775	1.530758
0.95	2.908337	1.591003	1.060474	1.550973
1	∞	1.570796	1	1.570796

When an analytical approximation is necessary, the following trigonometric series representations can be used.

- $$\mathbf{K} = \frac{\pi}{2} \left\{ 1 + \left(\frac{1}{2}\right)^2 k^2 + \left(\frac{1 \cdot 3}{2 \cdot 4}\right)^2 k^4 + \dots + \left[\frac{(2n-1)!!}{2^n n!}\right]^2 k^{2n} + \dots \right\}$$

Table 12.2. Short Table of Complete Elliptic Integrals of the First and Second Kinds with Argument Modular Angle α

$$\mathbf{K}(\alpha) = \int_0^{\pi/2} (1 - \sin^2 \alpha \sin^2 t)^{-1/2} dt \quad \mathbf{K}'(\alpha) = \int_0^{\pi/2} [1 - (1 - \sin^2 \alpha) \sin^2 t]^{-1/2} dt$$

$$\mathbf{E}(\alpha) = \int_0^{\pi/2} (1 - \sin^2 \alpha \sin^2 t)^{1/2} dt \quad \mathbf{E}'(\alpha) = \int_0^{\pi/2} [1 - (1 - \sin^2 \alpha) \sin^2 t]^{1/2} dt$$

α°	$\mathbf{K}(\alpha)$	$\mathbf{K}'(\alpha)$	$\mathbf{E}(\alpha)$	$\mathbf{E}'(\alpha)$
0	1.570796	∞	1.570796	1
5	1.573792	3.831742	1.567809	1.012664
10	1.582843	3.153385	1.558887	1.040114
15	1.598142	2.768063	1.544150	1.076405
20	1.620026	2.504550	1.523799	1.118378
25	1.648995	2.308787	1.498115	1.163828
30	1.685750	2.156516	1.467462	1.211056
35	1.731245	2.034715	1.432291	1.258680
40	1.786769	1.935581	1.393140	1.305539
45	1.854075	1.854075	1.350644	1.350644
50	1.935581	1.786769	1.305539	1.393140
55	2.034715	1.731245	1.258680	1.432291
60	2.156516	1.685750	1.211056	1.467462
65	2.308787	1.648995	1.163828	1.498115
70	2.504550	1.620026	1.118378	1.523799
75	2.768063	1.598142	1.076405	1.544150
80	3.153385	1.582843	1.040114	1.558887
85	3.831742	1.573792	1.012664	1.567809
90	∞	1.570796	1	1.570796

$$2. \quad \mathbf{K} = \frac{\pi}{1+k'} \left\{ 1 + \left(\frac{1}{2}\right)^2 \left(\frac{1-k'}{1+k'}\right)^2 + \left(\frac{1 \cdot 3}{2 \cdot 4}\right)^2 \left(\frac{1-k'}{1+k'}\right)^4 + \dots \right. \\ \left. + \left[\frac{(2n-1)!!}{2^n n!}\right]^2 \left(\frac{1-k'}{1+k'}\right)^{2n} + \dots \right\}$$

$$3. \quad \mathbf{K} = \ln\left(\frac{4}{k'}\right) + \left(\frac{1}{2}\right)^2 \left(\ln\left(\frac{4}{k'}\right) - \frac{2}{1 \cdot 2}\right) k'^2 \\ + \left(\frac{1 \cdot 3}{2 \cdot 4}\right)^2 \left(\ln\left(\frac{4}{k'}\right) - \frac{2}{1 \cdot 2} - \frac{2}{2 \cdot 3}\right) k'^4 + \dots \\ + \left(\frac{1 \cdot 3 \cdot 5}{2 \cdot 4 \cdot 6}\right)^2 \left(\ln\left(\frac{4}{k'}\right) - \frac{2}{1 \cdot 2} - \frac{2}{3 \cdot 4} - \frac{2}{5 \cdot 6}\right) k'^6 + \dots$$

$$4. \quad \mathbf{E} = \frac{\pi}{2} \left\{ 1 - \frac{1}{2^2} k^2 - \frac{1^2 \cdot 3}{2^2 \cdot 4} k^4 - \dots - \left[\frac{(2n-1)!!}{2^n n!} \right]^2 \frac{k^{2n}}{2n-1} - \dots \right\}$$

$$5. \quad \mathbf{E} = \frac{(1+k')\pi}{4} \left\{ 1 + \frac{1}{2^2} \left(\frac{1-k'}{1+k'} \right)^2 + \frac{1^2}{2^2 \cdot 4^2} \left(\frac{1-k'}{1+k'} \right)^4 + \dots \right. \\ \left. + \left[\frac{(2n-3)!!}{2^n n!} \right]^2 \left(\frac{1-k'}{1+k'} \right)^{2n} + \dots \right\}$$

$$6. \quad \mathbf{E} = 1 + \frac{1}{2} \left(\ln \left(\frac{4}{k'} \right) - \frac{2}{1 \cdot 2} \right) k'^2 + \frac{1^2 \cdot 3}{2^2 \cdot 4} \left(\ln \left(\frac{4}{k'} \right) - \frac{2}{1 \cdot 2} - \frac{1}{3 \cdot 4} \right) k'^4 \\ + \frac{1^2 \cdot 3^2 \cdot 5}{2^2 \cdot 4^2 \cdot 6} \left(\ln \left(\frac{4}{k'} \right) - \frac{2}{1 \cdot 2} - \frac{2}{3 \cdot 4} - \frac{2}{5 \cdot 6} \right) k'^6 + \dots$$

$$[(2n-1)!! = 1 \cdot 3 \cdot 5 \dots (2n-1)]$$

12.1.3 Tabulations and Trigonometric Series for $E(\varphi, k)$ and $F(\varphi, k)$

Abbreviated tabulations of incomplete elliptic integrals of the first and second kinds are given in Table 12.3, with the argument being the modular angle α ($k = \sin \alpha$). When an analytical approximation is necessary the following trigonometric series representations can be used. For small values of φ and k :

$$1. \quad F(\varphi, k) = \frac{2}{\pi} \mathbf{K} \varphi - \sin \varphi \cos \varphi \left(a_0 + \frac{2}{3} a_1 \sin^2 \varphi + \frac{2 \cdot 4}{3 \cdot 5} a_2 \sin^4 \varphi + \dots \right),$$

where

$$a_0 = \frac{2}{\pi} \mathbf{K} - 1, \quad a_n = a_{n-1} - \left[\frac{(2n-1)!!}{2^n n!} \right]^2 k^{2n}.$$

$$2. \quad E(\varphi, k) = \frac{2}{\pi} \mathbf{E} \varphi + \sin \varphi \cos \varphi \left(b_0 + \frac{2}{3} b_1 \sin^2 \varphi + \frac{2 \cdot 4}{3 \cdot 5} b_2 \sin^4 \varphi + \dots \right),$$

where

$$b_0 = 1 - \frac{2}{\pi} \mathbf{K}, \quad b_n = b_{n-1} - \left[\frac{(2n-1)!!}{2^n n!} \right]^2 \frac{k^{2n}}{2n-1}.$$

For k close to 1:

$$3. \quad F(\varphi, k) = \frac{2}{\pi} \mathbf{K}' \ln \tan \left(\frac{\varphi}{2} + \frac{\pi}{4} \right) - \frac{\tan \varphi}{\cos \varphi} \left(a'_0 - \frac{2}{3} a'_1 \tan^2 \varphi + \frac{2 \cdot 4}{3 \cdot 5} a'_2 \sin^4 \varphi - \dots \right),$$

where

$$a'_0 = \frac{2}{\pi} \mathbf{K}' - 1, \quad a'_n = a_{n-1} - \left[\frac{(2n-1)!!}{2^n n!} \right]^2 k'^{2n}.$$

Table 12.3. Short Table of Incomplete Elliptic Integrals of the First and Second Kinds with Argument Modular Angle α

		$F(\varphi, \alpha) = \int_0^\varphi (1 - \sin^2 \alpha \sin^2 t)^{-1/2} dt \quad [k = \sin \alpha]$									
		(α)									
(φ)		0°	10°	20°	30°	40°	50°	60°	70°	80°	90°
0°	0	0	0	0	0	0	0	0	0	0	0
10°	0.174533	0.174559	0.174636	0.174754	0.174899	0.175054	0.175200	0.175320	0.175399	0.175399	0.175426
20°	0.349066	0.349275	0.349880	0.350819	0.351989	0.353257	0.354472	0.355480	0.356146	0.356146	0.356379
30°	0.523599	0.524284	0.526284	0.529429	0.533427	0.537868	0.542229	0.545932	0.548425	0.548425	0.549306
40°	0.698132	0.699692	0.704287	0.711647	0.721262	0.732308	0.743581	0.753521	0.760426	0.760426	0.762910
50°	0.872665	0.875555	0.884162	0.898245	0.917255	0.940076	0.964652	0.987623	1.004439	1.004439	1.010683
60°	1.047198	1.051879	1.065969	1.089551	1.122557	1.164316	1.212597	1.261860	1.301353	1.301353	1.316958
70°	1.221730	1.228610	1.249526	1.285301	1.337228	1.406769	1.494411	1.595906	1.691815	1.691815	1.735415
80°	1.396263	1.405645	1.434416	1.484555	1.559734	1.665965	1.812530	2.011928	2.265272	2.265272	2.436246
90°	1.570796	1.582843	1.620026	1.685750	1.786769	1.935581	2.156516	2.504549	3.153384	3.153384	∞

		$E(\varphi, \alpha) = \int_0^\varphi (1 - \sin^2 \alpha \sin^2 t)^{1/2} dt \quad [k = \sin \alpha]$									
		(α)									
(φ)		0°	10°	20°	30°	40°	50°	60°	70°	80°	90°
0°	0	0	0	0	0	0	0	0	0	0	0
10°	0.174533	0.174506	0.174430	0.174312	0.174168	0.174015	0.173870	0.173752	0.173675	0.173675	0.173648
20°	0.349066	0.348857	0.348255	0.347329	0.346168	0.344963	0.343806	0.342858	0.342236	0.342236	0.342020
30°	0.523599	0.522915	0.520938	0.517882	0.514089	0.509995	0.506092	0.502868	0.500742	0.500742	0.500000
40°	0.698132	0.696578	0.692070	0.685060	0.676282	0.666705	0.657463	0.649737	0.644593	0.644593	0.642788
50°	0.872665	0.869790	0.861421	0.848317	0.831732	0.813383	0.795380	0.780066	0.769713	0.769713	0.766044
60°	1.047198	1.042550	1.028972	1.007556	0.980134	0.949298	0.918393	0.891436	0.872755	0.872755	0.866025
70°	1.221730	1.214913	1.194925	1.163177	1.122054	1.074998	1.026637	0.982976	0.951438	0.951438	0.939693
80°	1.396263	1.386979	1.359682	1.316058	1.258967	1.192553	1.122486	1.056482	1.005433	1.005433	0.984808
90°	1.570796	1.558887	1.523799	1.467462	1.393140	1.305539	1.211056	1.118378	1.040114	1.040114	1.000000

$$4. \quad E(\varphi, k) = \frac{2}{\pi}(\mathbf{K}' - \mathbf{E}') \ln \tan \left(\frac{\varphi}{2} + \frac{\pi}{4} \right) + \frac{\tan \varphi}{\cos \varphi} \left(b'_1 - \frac{2}{3} b'_2 \tan^2 \varphi + \frac{2 \cdot 4}{3 \cdot 5} b'_3 \tan^4 \varphi - \dots \right) \\ + \frac{1}{\sin \varphi} [1 - \cos \varphi \sqrt{1 - k^2 \sin^2 \varphi}],$$

where

$$b'_0 = \frac{2}{\pi}(\mathbf{K}' - \mathbf{E}'), \quad b'_n = b'_{n-1} - \left[\frac{(2n-3)!!}{2^{n-1}(n-1)!} \right]^2 \left(\frac{2n-1}{2n} \right) k'^{2n}.$$

12.2 JACOBIAN ELLIPTIC FUNCTIONS

12.2.1 The Functions $\operatorname{sn} u$, $\operatorname{cn} u$, and $\operatorname{dn} u$

12.2.1.1

The **Jacobian elliptic functions** are defined in terms of the elliptic integral

$$1. \quad u = \int_0^\varphi \frac{d\theta}{(1 - k^2 \sin^2 \theta)^{1/2}} = F(\varphi, k),$$

in which φ is called the **amplitude** of u and is written

$$2. \quad \varphi = \operatorname{am} u.$$

The Jacobian elliptic functions $\operatorname{sn} u$, $\operatorname{cn} u$, and $\operatorname{dn} u$ are defined as

$$3. \quad \operatorname{sn} u = \sin \varphi$$

$$4. \quad \operatorname{cn} u = \cos \varphi = (1 - \operatorname{sn}^2 u)^{1/2}$$

$$5. \quad \operatorname{dn} u = (1 - k^2 \sin^2 \varphi)^{1/2} = \Delta(\varphi) \quad (\text{the } \mathbf{\delta} \text{ amplitude})$$

In terms of the Legendre normal form of 12.2.1.1.1,

$$u = \int_0^x \frac{dv}{\sqrt{(1-v^2)(1-k^2v^2)}},$$

we have

$$6. \quad x = \sin \varphi = \operatorname{sn} u,$$

$$7. \quad \varphi = \operatorname{am} u = \arcsin(\operatorname{sn} u) = \arcsin x.$$

12.2.2 Basic Results

12.2.2.1 Even and Odd Properties and Special Values

$$1. \quad \operatorname{am}(-u) = -\operatorname{am} u \quad (\text{odd function})$$

$$2. \quad \operatorname{sn}(-u) = -\operatorname{sn} u \quad (\text{odd function})$$

$$3. \quad \text{cn}(-u) = \text{cn } u \quad (\text{even function})$$

$$4. \quad \text{dn}(-u) = \text{dn } u \quad (\text{even function})$$

$$5. \quad \text{am } 0 = 0$$

$$6. \quad \text{sn } 0 = 0$$

$$7. \quad \text{cn } 0 = 1$$

$$8. \quad \text{dn } 0 = 1$$

12.2.2.2 Identities

$$1. \quad \text{sn}^2 u + \text{cn}^2 u = 1$$

$$2. \quad \text{dn}^2 u + k^2 \text{sn}^2 u = 1$$

$$3. \quad \text{dn}^2 u - k^2 \text{cn}^2 u = 1 - k^2$$

12.2.2.3 Addition Formulas for Double and Half-Arguments

$$1. \quad \text{sn}(u \pm v) = \frac{\text{sn } u \text{ cn } v \text{ dn } v \pm \text{cn } u \text{ sn } v \text{ dn } u}{1 - k^2 \text{sn}^2 u \text{sn}^2 v}$$

$$2. \quad \text{cn}(u \pm v) = \frac{\text{cn } u \text{ cn } v \mp \text{sn } u \text{ dn } u \text{ sn } v \text{ dn } v}{1 - k^2 \text{sn}^2 u \text{sn}^2 v}$$

$$3. \quad \text{dn}(u \pm v) = \frac{\text{dn } u \text{ dn } v \mp k^2 \text{sn } u \text{ cn } u \text{ sn } v \text{ cn } v}{1 - k^2 \text{sn}^2 u \text{sn}^2 v}$$

$$4. \quad \text{sn}(2u) = \frac{2 \text{sn } u \text{ cn } u \text{ dn } u}{1 - k^2 \text{sn}^4 u}$$

$$5. \quad \text{cn}(2u) = \frac{\text{cn}^2 u - \text{sn}^2 u \text{ dn}^2 u}{1 - k^2 \text{sn}^4 u}$$

$$6. \quad \text{dn}(2u) = \frac{\text{dn}^2 u - k^2 \text{sn}^2 u \text{ cn}^2 u}{1 - k^2 \text{sn}^4 u}$$

$$7. \quad \text{sn}\left(\frac{1}{2}u\right) = \left(\frac{1 - \text{cn } u}{1 + \text{dn } u}\right)^{1/2}$$

$$8. \quad \text{cn}\left(\frac{1}{2}u\right) = \left(\frac{\text{cn } u + \text{dn } u}{1 + \text{dn } u}\right)^{1/2}$$

$$9. \quad \text{dn}\left(\frac{1}{2}u\right) = \left(\frac{\text{cn } u + \text{dn } u}{1 + \text{cn } u}\right)^{1/2}$$

12.2.2.4 Series Expansions of $\operatorname{sn} u$, $\operatorname{cn} u$, $\operatorname{dn} u$, and $\operatorname{am} u$ in Powers of u

Using the notation $pq(u | k^2)$ to signify that pq is a function of u and k^2 we have:

1. $\operatorname{sn}(u | k^2) = u - \frac{1}{3!}(1 + k^2)u^3 + \frac{1}{5!}(1 + 14k^2 + k^4)u^5 - \dots$
2. $\operatorname{cn}(u | k^2) = 1 - \frac{1}{2!}(1 + k^2)u^2 + \frac{1}{4!}(1 + 4k^2)u^4 - \frac{1}{6!}(1 + 44k^2 + 16k^4)u^6 + \dots$
3. $\operatorname{dn}(u | k^2) = 1 - \frac{1}{2!}k^2u^2 + \frac{1}{4!}k^2(4 + k^2)u^4 - \frac{1}{6!}k^2(16 + 44k^2 + k^4)u^6 + \dots$
4. $\operatorname{am}(u | k^2) = u - \frac{1}{3!}k^2u^3 + \frac{1}{5!}k^2(4 + k^2)u^5 - \frac{1}{7!}k^2(16 + 44k^2 + k^4)u^7 + \dots$
5. $\operatorname{sn}(u | 0) = \sin u$
6. $\operatorname{cn}(u | 0) = \cos u$
7. $\operatorname{dn}(u | 0) = 1$
8. $\operatorname{sn}(u | 1) = \tanh u$
9. $\operatorname{cn}(u | 1) = \operatorname{sech} u$
10. $\operatorname{dn}(u | 1) = \operatorname{sech} u$

12.3 DERIVATIVES AND INTEGRALS

12.3.1 Derivatives of $\operatorname{sn} u$, $\operatorname{cn} u$, and $\operatorname{dn} u$

12.3.1.1

1. $\frac{d}{du}[\operatorname{sn} u] = \operatorname{cn} u \operatorname{dn} u$
2. $\frac{d}{du}[\operatorname{cn} u] = -\operatorname{sn} u \operatorname{dn} u$
3. $\frac{d}{du}[\operatorname{dn} u] = -k^2 \operatorname{sn} u \operatorname{cn} u$

12.3.2 Integrals Involving $\operatorname{sn} u$, $\operatorname{cn} u$, and $\operatorname{dn} u$

12.3.2.1

1. $\int \operatorname{sn} u \operatorname{dn} u = \frac{1}{k}(\operatorname{dn} u - k \operatorname{cn} u)$

2. $\int \operatorname{cn} u \, du = \frac{1}{k} \arccos(\operatorname{dn} u)$
3. $\int \operatorname{dn} u \, du = \arcsin(\operatorname{sn} u) = \operatorname{am} u$
4. $\int \frac{du}{\operatorname{sn} u} = \ln \left| \frac{\operatorname{sn} u}{\operatorname{cn} u + \operatorname{dn} u} \right|$
5. $\int \frac{du}{\operatorname{cn} u} = \left(\frac{1}{1-k^2} \right) \ln \left| \frac{(1-k^2)\operatorname{sn} u + \operatorname{dn} u}{\operatorname{cn} u} \right|$
6. $\int \frac{du}{\operatorname{dn} u} = \left(\frac{1}{1-k^2} \right) \arctan \left| \frac{(1-k^2)\operatorname{sn} u - \operatorname{cn} u}{(1-k^2)\operatorname{sn} u + \operatorname{cn} u} \right|$

12.4 INVERSE JACOBIAN ELLIPTIC FUNCTIONS

12.4.1 Definitions

12.4.1.1 $\operatorname{sn}^{-1} u$, $\operatorname{cn}^{-1} u$, and $\operatorname{dn}^{-1} u$

Each Jacobian elliptic function is the inverse of an appropriate elliptic integral. Since $\varphi = \operatorname{am} u$ and

$$1. \quad u = \int_0^\varphi \frac{d\theta}{(1-k^2 \sin^2 \theta)^{1/2}} \quad [0 < \varphi \leq \pi/2],$$

it follows that

$$2. \quad \operatorname{am}^{-1} \varphi = \int_0^\varphi \frac{d\theta}{(1-k^2 \sin^2 \theta)^{1/2}} = F(\varphi, k).$$

Analogously,

$$3. \quad \operatorname{sn}^{-1} u = \int_0^u \frac{dx}{\sqrt{(1-x^2)(1-k^2x^2)}} = F(\arcsin x, k) \quad [0 < x \leq 1]$$

$$4. \quad \operatorname{cn}^{-1} u = \int_u^1 \frac{dx}{\sqrt{(1-x^2)(1-k^2+k^2x^2)}} = F(\arcsin \sqrt{1-x^2}, k) \quad [0 \leq x < 1]$$

$$5. \quad \operatorname{dn}^{-1} u = \int_u^1 \frac{dx}{\sqrt{(1-x^2)(x^2+k^2-1)}} = F(\arcsin \sqrt{(1-x^2)/k^2}, k) \quad [1-k^2 \leq x < 1]$$

12.4.1.2 Special Values

1. $\operatorname{sn}^{-1}(\varphi, 1) = \ln|\sec \varphi + \tan \varphi|$
2. $\operatorname{cn}^{-1}(u, 1) = \ln|(1+u)^{1/2}(1-u)^{-1/2}|$

$$3. \quad \operatorname{dn}^{-1}(u, 1) = \ln|[1 + (1 - u^2)^{1/2}]/u|$$

$$4. \quad \operatorname{sn}^{-1}(u, 0) = \arcsin u$$

$$5. \quad \operatorname{cn}^{-1}(u, 0) = \arccos u$$

12.4.1.3 Integrals of $\operatorname{sn}^{-1} u$, $\operatorname{cn}^{-1} u$, and $\operatorname{dn}^{-1} u$

$$1. \quad \int \operatorname{sn}^{-1} u \, du = u \operatorname{sn}^{-1} u + \frac{1}{k} \operatorname{cosh} \left[\frac{(1 - k^2 u^2)^{1/2}}{1 - k^2} \right]$$

$$2. \quad \int \operatorname{cn}^{-1} u \, du = u \operatorname{cn}^{-1} u - \frac{1}{k} \operatorname{arccosh}[(1 - k^2 + k^2 u^2)^{1/2}]$$

$$3. \quad \int \operatorname{dn}^{-1} u \, du = u \operatorname{dn}^{-1} u - \arcsin \left[\frac{(1 - u^2)^{1/2}}{k} \right]$$

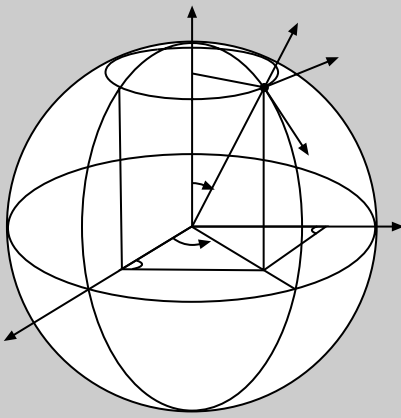

Chapter 13

Probability Distributions and Integrals, and the Error Function

13.1 DISTRIBUTIONS

13.1.1 Definitions

13.1.1.1 The Normal or Gaussian Probability Density Function

$$1. \quad f(x) = \frac{1}{\sigma\sqrt{2\pi}} \exp\left\{-\frac{1}{2}\left(\frac{x-\mu}{\sigma}\right)^2\right\},$$

is symmetrical about $x = \mu$ and such that

$$2. \quad \int_{-\infty}^{\infty} f(x) dx = \frac{1}{\sigma\sqrt{2\pi}} \int_{-\infty}^{\infty} \exp\left\{-\frac{1}{2}\left(\frac{x-\mu}{\sigma}\right)^2\right\} dx = 1.$$

The distribution has a **mean** of

$$3. \quad \mu = \int_{-\infty}^{\infty} xf(x) dx = \frac{1}{\sigma\sqrt{2\pi}} \int_{-\infty}^{\infty} x \exp\left\{-\frac{1}{2}\left(\frac{x-\mu}{\sigma}\right)^2\right\} dx$$

and a **variance** of

$$4. \quad \sigma^2 = \frac{1}{\sigma\sqrt{2\pi}} \int_{-\infty}^{\infty} (x-\mu)^2 \exp\left\{-\frac{1}{2}\left(\frac{x-\mu}{\sigma}\right)^2\right\} dx.$$

When the normal probability density $f(x)$ is standardized with zero mean ($\mu = 0$) and unit variance ($\sigma = 1$) the **normal probability distribution** $P(x)$, also denoted by $\Phi(x)$, is defined as

$$5. \quad P(x) = \frac{1}{\sqrt{2\pi}} \int_{-\infty}^x e^{-t^2/2} dt.$$

Related functions used in statistics are

$$6. \quad Q(x) = \frac{1}{\sqrt{2\pi}} \int_x^{\infty} e^{-t^2/2} dt = 1 - P(x) = P(-x)$$

$$7. \quad A(x) = \frac{1}{\sqrt{2\pi}} \int_{-x}^x e^{-t^2/2} dt = 2P(x) - 1.$$

Special values of $P(x)$, $Q(x)$, and $A(x)$ are

$$P(-\infty) = 0, \quad P(0) = 0.5, \quad P(\infty) = 1, \quad Q(-\infty) = 1, \quad Q(0) = 0.5,$$

$$Q(\infty) = 0, \quad A(0) = 0, \quad A(\infty) = 1.$$

An abbreviated tabulation of $P(x)$, $Q(x)$, and $A(x)$ is given in Table 13.1.

13.1.1.2

The **binomial distribution**, also called the **Bernoulli distribution**, is a discrete distribution that describes the behavior of n independent random variables, x_1, x_2, \dots, x_n , often called *experiments*, that can assume one of two different states, say A and B . Let the probability of occurrence of state A be p , in which case the probability of occurrence of state B will be $1 - p$. Then in a test of n trials, the probability $P(k)$ that state A will occur precisely k times is

$$P(k) = \binom{n}{k} p^k (1-p)^{n-k} = \frac{n!}{k!(n-k)!} p^k (1-p)^{n-k} \quad (k = 1, 2, \dots, n)$$

The **mean value** μ of the binomial distribution, also called the **mathematical expectation** and denoted by $E(x_n)$, is given by $\mu = E(x_n) = np$ and the **variance** of the binomial distribution is given by $\sigma^2 = np(1-p)$. A set of n independent random trials with the probability that the occurrence of event A is given by $P(k)$ is said to satisfy a binomial distribution.

A typical example of a set of trials described by a binomial distribution occurs when a coin is flipped n times. In this case if state A is the occurrence of “heads” and state B is the occurrence of “tails,” the probability of the occurrence of “heads” will only be $p = 0.5$ if the coin is unbiased; otherwise, $p \neq 0.5$.

When n is large, provided p and $1 - p$ are not too small, the binomial distribution can be approximated by the normal distribution in **13.1.1.1**, using as the mean $\mu = np$ and as the variance $\sigma^2 = np(1-p)$ to arrive at the approximation

$$\lim_{n \rightarrow \infty} P\left(\frac{x_n - \mu}{\sigma} \leq \kappa\right) = \frac{1}{\sqrt{2\pi}} \int_{-\infty}^{\kappa} \exp\left(-\frac{1}{2}s^2\right) ds.$$

This provides a good approximation when $p \approx 0.5$ and n is large, though the approximation is also used when p is not close to 0.5, provided both np and $n(1-p)$ exceed 4.

When either p or $1 - p$ are small, this approximation fails, and the binomial distribution must be approximated by the *Poisson distribution* (see **13.1.1.3**).

Table 13.1. Abbreviated Tabulation of $P(x)$, $Q(x)$, $A(x)$, and $\operatorname{erf} x$

x	$P(x)$	$Q(x)$	$A(x)$	$\operatorname{erf} x$
0	0.5	0.5	0	0
0.1	0.539828	0.460172	0.079656	0.112463
0.2	0.579260	0.420740	0.158519	0.222702
0.3	0.617911	0.382089	0.235823	0.328627
0.4	0.655422	0.344578	0.310843	0.428392
0.5	0.691462	0.308538	0.382925	0.520500
0.6	0.725747	0.274253	0.451494	0.603856
0.7	0.758036	0.241964	0.516073	0.677801
0.8	0.788145	0.211855	0.576289	0.742101
0.9	0.815940	0.184060	0.631880	0.796908
1.0	0.841345	0.158655	0.682689	0.842701
1.1	0.864334	0.135666	0.728668	0.880205
1.2	0.884930	0.115070	0.769861	0.910314
1.3	0.903199	0.096801	0.806399	0.934008
1.4	0.919243	0.080757	0.838487	0.952285
1.5	0.933193	0.066807	0.866386	0.966105
1.6	0.945201	0.054799	0.890401	0.976348
1.7	0.955435	0.044565	0.910869	0.983790
1.8	0.964070	0.035930	0.928139	0.989090
1.9	0.971284	0.028716	0.942567	0.992790
2.0	0.977250	0.022750	0.954500	0.995322
2.1	0.982136	0.017864	0.964271	0.997020
2.2	0.986097	0.013903	0.972193	0.998137
2.3	0.989276	0.010724	0.978552	0.998857
2.4	0.991802	0.008198	0.983605	0.999311
2.5	0.993790	0.006210	0.987581	0.999593
2.6	0.995339	0.004661	0.990678	0.999764
2.7	0.996533	0.003467	0.993066	0.999866
2.8	0.997445	0.002555	0.994890	0.999925
2.9	0.998134	0.001866	0.996268	0.999959
3.0	0.998650	0.001350	0.997300	0.999978
∞	1	0	1	1

13.1.1.3

The Poisson distribution is a discrete distribution of random variables x that are non-negative integers, where the probability that $x = k$, written $P(k)$ is given by

$$P(k) = \frac{\lambda^k}{k!} e^{-\lambda} \quad (\mu > 0, k = 0, 1, 2, \dots).$$

The number λ is called the *parameter* of the Poisson distribution, and its mean and variance are given by

$$\mu = \lambda \quad \text{and} \quad \sigma^2 = \lambda.$$

A typical application of the Poisson distribution is in the analysis of rare events, like floods or freak accidents.

13.1.2 Power Series Representations ($x \geq 0$)

13.1.2.1

$$1. \quad P(x) = \frac{1}{2} + \frac{1}{\sqrt{2\pi}} \left\{ x - \frac{x^3}{6} + \frac{x^5}{40} - \frac{x^7}{336} + \frac{x^9}{3456} - \cdots \right\}$$

$$= \frac{1}{2} + \frac{1}{\sqrt{2\pi}} \sum_{k=0}^{\infty} \frac{(-1)^k x^{2k+1}}{k! 2^k (2k+1)} \quad [x \geq 0]$$

$$2. \quad Q(x) = \frac{1}{2} - \frac{1}{\sqrt{2\pi}} \left\{ x - \frac{x^3}{6} + \frac{x^5}{40} - \frac{x^7}{336} + \frac{x^9}{3456} - \cdots \right\}$$

$$= \frac{1}{2} - \frac{1}{\sqrt{2\pi}} \sum_{k=0}^{\infty} \frac{(-1)^k x^{2k+1}}{k! 2^k (2k+1)} \quad [x \geq 0]$$

$$3. \quad A(x) = \sqrt{\frac{2}{\pi}} \left\{ x - \frac{x^3}{6} + \frac{x^5}{40} - \frac{x^7}{336} + \frac{x^9}{3456} - \cdots \right\}$$

$$= \sqrt{\frac{2}{\pi}} \sum_{k=0}^{\infty} \frac{(-1)^k x^{2k+1}}{k! 2^k (2k+1)} \quad [x \geq 0]$$

13.1.3 Asymptotic Expansions ($x \gg 0$)

13.1.3.1

$$1. \quad P(x) \sim 1 - \frac{1}{\sqrt{2\pi}} \frac{e^{-x^2/2}}{x} \left[1 - \frac{1}{x^2} + \frac{1 \cdot 3}{x^4} - \frac{1 \cdot 3 \cdot 5}{x^6} + \cdots \right. \\ \left. + \frac{(-1)^n 1 \cdot 3 \cdot 5 \cdots (2n-1)}{x^{2n}} \right] + R_n,$$

where the remainder (error) term R_n is such that $|R_n|$ is less than the magnitude of the first term to be neglected in the asymptotic expansion and of the same sign for $x \gg 0$.

$$2. \quad Q(x) \sim \frac{1}{\sqrt{2\pi}} \frac{e^{-x^2/2}}{x} \left[1 - \frac{1}{x^2} + \frac{1 \cdot 3}{x^4} - \frac{1 \cdot 3 \cdot 5}{x^6} + \cdots \right. \\ \left. + \frac{(-1)^n 1 \cdot 3 \cdot 5 \cdots (2n-1)}{x^{2n}} \right] + R_n,$$

where the remainder (error) term R_n is such that $|R_n|$ is less than the magnitude of the first term to be neglected in the asymptotic expansion and of the same sign for $x \gg 0$.

$$3. \quad A(x) \sim 1 - \sqrt{\frac{2}{\pi}} \frac{e^{-x^2/2}}{x} \left[1 - \frac{1}{x^2} + \frac{1 \cdot 3}{x^4} - \frac{1 \cdot 3 \cdot 5}{x^6} + \dots + \frac{(-1)^n 1 \cdot 3 \cdot 5 \cdots (2n-1)}{x^{2n}} \right] + R_n,$$

where the remainder (error) term R_n is such that $|R_n|$ is less than the magnitude of the first term to be neglected in the asymptotic expansion and of the same sign for $x \gg 0$.

13.2 THE ERROR FUNCTION

13.2.1 Definitions

13.2.1.1

The **error function** $\operatorname{erf} x$ occurs in probability theory and statistics and diffusion problems, and is defined as

$$1. \quad \operatorname{erf} x = \frac{2}{\sqrt{\pi}} \int_0^x e^{-t^2} dt,$$

and it obeys the **symmetry relation**

$$2. \quad \operatorname{erf}(-x) = -\operatorname{erf} x.$$

Special values of $\operatorname{erf} x$ are

$$3. \quad \operatorname{erf} 0 = 0 \quad \text{and} \quad \operatorname{erf} \infty = 1.$$

The **complementary error function** $\operatorname{erfc} x$ is defined as

$$4. \quad \operatorname{erfc} x = 1 - \operatorname{erf} x.$$

13.2.2 Power Series Representation

13.2.2.1

$$1. \quad \operatorname{erf} x = \frac{2}{\sqrt{\pi}} \left\{ x - \frac{x^3}{3} + \frac{x^5}{10} - \frac{x^7}{42} + \frac{x^9}{216} - \dots \right\} \\ = \frac{2}{\sqrt{\pi}} \sum_{k=0}^{\infty} \frac{(-1)^k x^{2k+1}}{k!(2k+1)}.$$

An abbreviated tabulation of $\operatorname{erf} x$ is given in Table 13.1.

13.2.3 Asymptotic Expansion ($x \gg 0$)

13.2.3.1

$$1. \quad \operatorname{erf} x \sim 1 - \frac{e^{-x^2}}{x\sqrt{\pi}} \left\{ 1 - \frac{1}{2x^2} + \frac{1 \cdot 3}{2^2 x^4} - \frac{1 \cdot 3 \cdot 5}{2^3 x^6} + \dots + \frac{(-1)^n (2n)!}{n! 2^{2n} x^{2n}} \right\} + R_n$$

where the remainder (error) term R_n is less than the magnitude of the first term to be neglected in the asymptotic expansion and of the same sign, for $x \gg 0$.

13.2.4 Connection Between $P(x)$ and $\operatorname{erf} x$

13.2.4.1

$$1. \quad P(x) = \frac{1}{2} \left[1 + \operatorname{erf} \frac{x}{\sqrt{2}} \right].$$

13.2.5 Integrals Expressible in Terms of $\operatorname{erf} x$

13.2.5.1

$$1. \quad \int_0^\infty e^{-t^2} \frac{\sin 2tx}{t} dt = \frac{1}{2} \pi \operatorname{erf} x$$

$$2. \quad \int_0^\infty e^{-t^2} \sin 2tx dx = \frac{1}{2} \sqrt{\pi} e^{-x^2} \operatorname{erf} x$$

13.2.6 Derivatives of $\operatorname{erf} x$

13.2.6.1

$$1. \quad \frac{d}{dx} [\operatorname{erf} x] = \frac{2}{\sqrt{\pi}} e^{-x^2}$$

$$2. \quad \frac{d^2}{dx^2} [\operatorname{erf} x] = -\frac{4}{\sqrt{\pi}} x e^{-x^2}$$

$$3. \quad \frac{d^3}{dx^3} [\operatorname{erf} x] = -\frac{1}{\sqrt{\pi}} (8x^2 - 4) e^{-x^2}$$

$$4. \quad \frac{d^4}{dx^4} [\operatorname{erf} x] = -\frac{8}{\sqrt{\pi}} (3 - 2x^2) x e^{-x^2}$$

13.2.7 Integrals of $\operatorname{erfc} x$

13.2.7.1

The n 'th repeated integral of $\operatorname{erfc} x$ arises in the study of diffusion and heat conduction and is denoted by $i^n \operatorname{erfc} x$, with

$$1. \quad i^n \operatorname{erfc} x = \int_x^\infty i^{n-1} \operatorname{erfc} t dt \quad [n = 0, 1, 2, \dots],$$

$$2. \quad i^{-1} \operatorname{erfc} x = \frac{2}{\sqrt{\pi}} e^{-x^2} \quad \text{and} \quad i^0 \operatorname{erfc} x = \operatorname{erfc} x.$$

In particular,

$$3. \quad i \operatorname{erfc} x = -\frac{1}{\pi} e^{-x^2} - x \operatorname{erfc} x$$

$$4. \quad i^2 \operatorname{erfc} x = -\frac{1}{4} (\operatorname{erfc} x - 2x i \operatorname{erfc} x)$$

and $i^n \operatorname{erfc} x$ satisfies the **recurrence relation**

$$5. \quad 2n i^n \operatorname{erfc} x = -i^{n-2} \operatorname{erfc} x + 2x i^{n-1} \operatorname{erfc} x \quad [n = 1, 2, 3, \dots].$$

13.2.8 Integral and Power Series Representation of $i^n \operatorname{erfc} x$

13.2.8.1

$$1. \quad i^n \operatorname{erfc} x = \frac{2}{\sqrt{\pi}} \int_x^\infty \frac{(t-x)^n}{n!} e^{-t^2} dt$$

$$2. \quad i^n \operatorname{erfc} x = \sum_{k=0}^{\infty} \frac{(-1)^k x^k}{2^{n-k} k! \Gamma\left(1 + \frac{n-k}{2}\right)}$$

13.2.9 Value of $i^n \operatorname{erfc} x$ at zero

13.2.9.1

$$1. \quad i^n \operatorname{erfc} 0 = \frac{1}{2^n \Gamma(1 + n/2)}$$

$$2. \quad i^0 \operatorname{erfc} 0 = 1, \quad i^1 \operatorname{erfc} 0 = 1/\sqrt{\pi}, \quad i^2 \operatorname{erfc} 0 = 1/4$$

$$i^3 \operatorname{erfc} 0 = 1/(6\sqrt{\pi}), \quad i^4 \operatorname{erfc} 0 = 1/32, \quad i^5 \operatorname{erfc} 0 = 1/(60\sqrt{\pi})$$

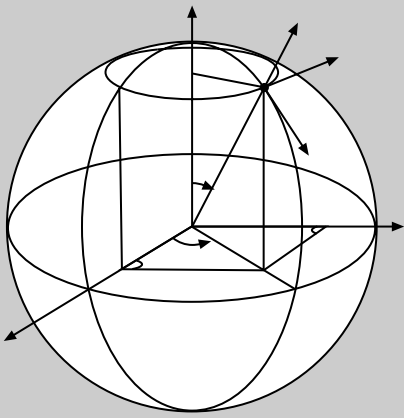

Chapter 14

Fresnel Integrals, Sine and Cosine Integrals

14.1 DEFINITIONS, SERIES REPRESENTATIONS, AND VALUES AT INFINITY

14.1.1 The Fresnel Integrals

14.1.1.1

The Fresnel integrals arise in diffraction problems and they are defined as

$$1. \quad C(x) = \int_0^x \cos\left(\frac{\pi}{2}t^2\right) dt$$

$$2. \quad S(x) = \int_0^x \sin\left(\frac{\pi}{2}t^2\right) dt$$

14.1.2 Series Representations

14.1.2.1

$$1. \quad C(x) = \sum_{n=0}^{\infty} \frac{(-1)^n (\pi/2)^{2n}}{(2n)!(4n+1)} x^{4n+1}$$

$$2. \quad C(x) = \cos\left(\frac{\pi}{2}x^2\right) \sum_{n=0}^{\infty} \frac{(-1)^n \pi^{2n}}{1 \cdot 3 \cdot 5 \cdots (4n+1)} x^{4n+1}$$

$$+ \sin\left(\frac{\pi}{2}x^2\right) \sum_{n=0}^{\infty} \frac{(-1)^n \pi^{2n+1}}{1 \cdot 3 \cdot 5 \cdots (4n+3)} x^{4n+3}$$

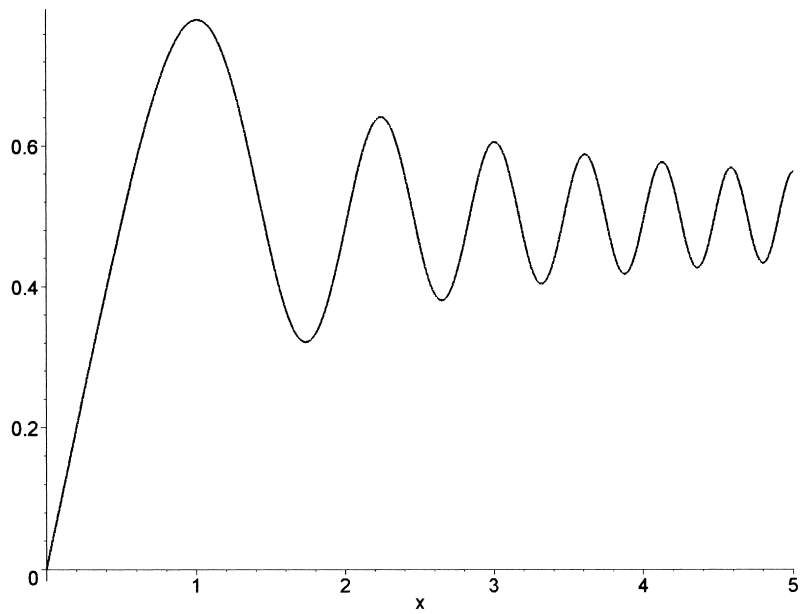

Figure 14.1. Fresnel integral $C(x)$.

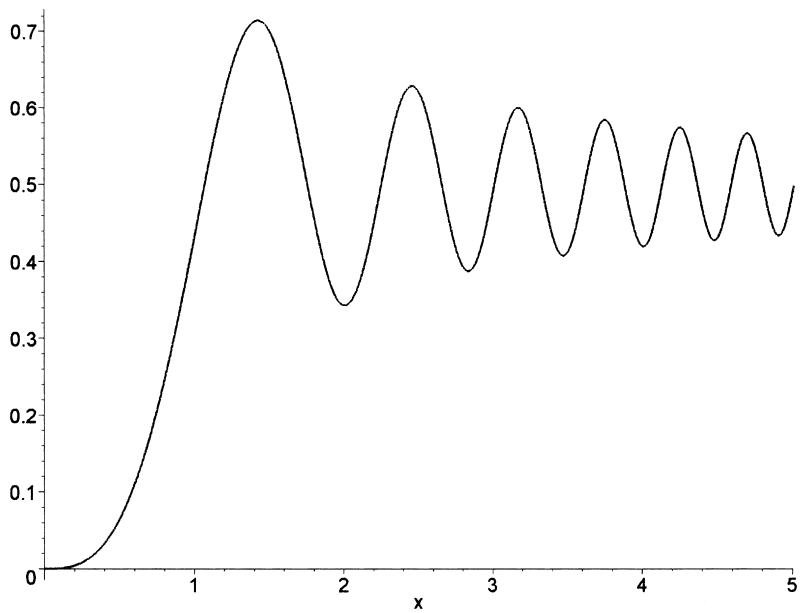

Figure 14.2. Fresnel integral $S(x)$.

$$3. \quad S(x) = \sum_{n=0}^{\infty} \frac{(-1)^n (\pi/2)^{2n+1}}{(2n+1)!(4n+3)} x^{4n+3}$$

$$4. \quad S(x) = -\cos\left(\frac{\pi}{2}x^2\right) \sum_{n=0}^{\infty} \frac{(-1)^n \pi^{2n+1}}{1 \cdot 3 \cdot 5 \cdots (4n+3)} x^{4n+3} \\ + \sin\left(\frac{\pi}{2}x^2\right) \sum_{n=0}^{\infty} \frac{(-1)^n \pi^{2n}}{1 \cdot 3 \cdot 5 \cdots (4n+1)} x^{4n+1}$$

14.1.3 Limiting Values as $x \rightarrow \infty$

14.1.3.1

$$1. \quad \lim_{x \rightarrow \infty} C(x) = \frac{1}{2}, \quad \lim_{x \rightarrow \infty} S(x) = \frac{1}{2}$$

14.2 DEFINITIONS, SERIES REPRESENTATIONS, AND VALUES AT INFINITY

14.2.1 Sine and Cosine Integrals

14.2.1.1

The sine and cosine integrals are defined as

$$1. \quad \text{Si}(x) = \int_0^x \frac{\sin t}{t} dt$$

$$2. \quad \text{Ci}(x) = \gamma + \ln x + \int_0^x \frac{\cos t - 1}{t} dt$$

$$\gamma = 0.57721\,56649\dots \quad (\text{Euler's constant})$$

14.2.2 Series Representations

14.2.2.1

$$1. \quad \text{Si}(x) = \sum_{n=0}^{\infty} \frac{(-1)^n x^{2n+1}}{(2n+1)(2n+1)!}$$

$$2. \quad \text{Ci}(x) = \gamma + \ln x + \sum_{n=1}^{\infty} \frac{(-1)^n x^{2n}}{2n(2n)!}$$

14.2.3 Limiting values as $x \rightarrow \infty$

14.2.3.1

1. $\lim_{x \rightarrow \infty} \text{Si}(x) = \pi/2, \quad \lim_{x \rightarrow \infty} \text{Ci}(x) = 0$

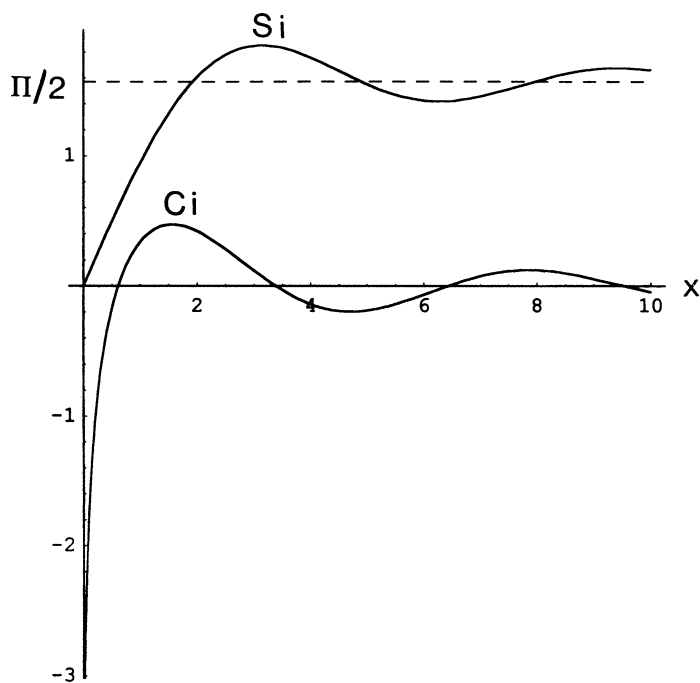
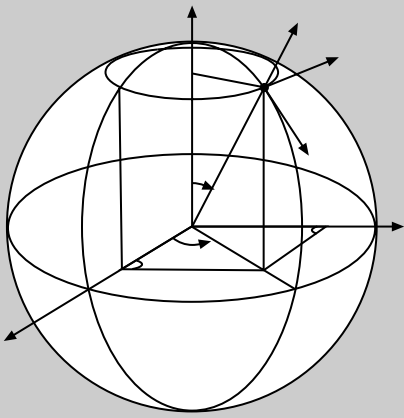

Figure 14.3. Sine integral $\text{Si}(x)$ and cosine integral $\text{Ci}(x)$.



Chapter 15

Definite Integrals

15.1 INTEGRANDS INVOLVING POWERS OF x

15.1.1

1. $\int_1^{\infty} \frac{dx}{x^n} = \frac{1}{n-1} \quad [n > 1]$
2. $\int_0^{\infty} \frac{x^{p-1} dx}{1+x} = \frac{\pi}{\sin p\pi} \quad [0 < p < 1]$
3. $\int_0^1 \frac{x^{p-1} - x^{-p}}{1+x} dx = \pi \operatorname{cosec} p\pi \quad [p^2 < 1]$
4. $\int_0^1 \frac{x^p - x^{-p}}{1+x} dx = \frac{1}{p} - \pi \operatorname{cosec} p\pi \quad [p^2 < 1]$
5. $\int_0^1 \frac{x^{p-1} - x^{-p}}{1-x} dx = \pi \cot p\pi \quad [p^2 < 1]$
6. $\int_0^1 \frac{x^p - x^{-p}}{x-1} dx = \frac{1}{p} - \pi \cot p\pi \quad [p^2 < 1]$
7. $\int_0^{\infty} \frac{x^{p-1} - x^{q-1}}{1-x} dx = \pi(\cot p\pi - \cot q\pi) \quad [p > 0, q > 0]$
8. $\int_0^1 \frac{x^p - x^{-p}}{1-x^2} dx = \frac{\pi}{2} \cot \frac{p\pi}{2} - \frac{1}{p} \quad [p^2 < 1]$

9. $\int_0^1 \frac{x^p - x^{-p}}{1 + x^2} dx = \frac{1}{p} - \frac{\pi}{2} \operatorname{cosec} \frac{p\pi}{2} \quad [p^2 < 1]$
10. $\int_0^\infty \frac{x^{p-1} dx}{1 - x^q} = \frac{\pi}{q} \cot \frac{p\pi}{q} \quad [p < q]$
11. $\int_0^\infty \frac{x^{p-1} dx}{1 - x^q} = \frac{\pi}{q} \operatorname{cosec} \frac{p\pi}{q} \quad [0 < p < q]$
12. $\int_0^\infty \frac{x^{p-1} dx}{(1 + x^q)^2} = \frac{(p - q)\pi}{q^2} \operatorname{cosec} \frac{(p - q)\pi}{q} \quad [p < 2q]$
13. $\int_0^\infty \frac{x^{p+1} dx}{(1 + x^2)^2} = \frac{p\pi}{4} \operatorname{cosec} \frac{p\pi}{2} \quad [|p| < 2]$
14. $\int_0^\infty \frac{x^{2n+1} dx}{\sqrt{1 - x^2}} = \frac{(2n)!!}{(2n + 1)!!}$
15. $\int_0^\infty \frac{a dx}{a^2 + x^2} = \begin{cases} \frac{\pi}{2} \sin a, & a \neq 0 \\ 0, & a = 0 \end{cases}$
16. $\int_0^\infty \frac{dx}{(a^2 + x^2)(b^2 + x^2)} = \frac{\pi}{2ab(a + b)}$
17. $\int_0^\infty \frac{x^{p-1} dx}{(a^2 + x^2)(b^2 + x^2)} = \frac{\pi}{2} \frac{b^{p-2} - a^{p-2}}{a^2 - b^2} \operatorname{cosec} \frac{p\pi}{2} \quad [a > 0, b > 0, 0 < p < 4]$
18. $\int_0^\infty \frac{x^{p-1} dx}{(a^2 + x^2)(b^2 - x^2)} = \frac{\pi}{2} \frac{a^{p-2} + b^{p-2} \cos \frac{p\pi}{2}}{a^2 + b^2} \operatorname{cosec} \frac{p\pi}{2} \quad [a > 0, b > 0, 0 < p < 4]$
19. $\int_0^\infty \frac{dx}{(ax^2 + 2bx + c)^n} = \frac{(-1)^{n-1}}{(n-1)!} \frac{\partial^{n-1}}{\partial c^{n-1}} \left[\frac{1}{\sqrt{ac - b^2}} \operatorname{arccot} \frac{b}{\sqrt{ac - b^2}} \right] \quad [a > 0, ac > b^2]$
20. $\int_{-\infty}^\infty \frac{dx}{(ax^2 + 2bx + c)^n} = \frac{(2n-3)!! \pi a^{n-1}}{(2n-2)!! (ac - b^2)^{n-(1/2)}} \quad [a > 0, ac > b^2]$
21. $\int_0^\infty \frac{x dx}{(ax^2 + 2bx + c)^n}$
 $= \frac{(-1)^n}{(n-1)!} \frac{\partial^{n-2}}{\partial c^{n-2}} \left[\frac{1}{2(ac - b^2)} - \frac{b}{2(ac - b^2)^{3/2}} \operatorname{arccot} \frac{b}{\sqrt{ac - b^2}} \right] \quad [ac > b^2]$
 $= \frac{(-1)^n}{(n-1)!} \frac{\partial^{n-2}}{\partial c^{n-2}} \left[\frac{1}{2(ac - b^2)} + \frac{b}{4(b^2 - ac)^{3/2}} \ln \left(\frac{b + \sqrt{b^2 - ac}}{b - \sqrt{b^2 - ac}} \right) \right] \quad [b^2 > ac > 0]$

$$= \frac{a^{n-2}}{2(n-1)(2n-1)b^{2n-2}} \quad [ac = b^2, a > 0, b > 0, n \geq 2]$$

$$22. \int_{-\infty}^{\infty} \frac{x \, dx}{(ax^2 + 2bx + c)^n} = -\frac{(2n-3)!!\pi ba^{n-2}}{(2n-2)!!(ac-b^2)^{(2n-1)/2}} \quad [ac > b^2, a > 0, n \geq 2]$$

$$23. \int_0^{\infty} (\sqrt{x^2 + a^2} - x)^n \, dx = \frac{na^{n+1}}{n^2 - 1} \quad [n \geq 2]$$

$$24. \int_0^{\infty} \frac{dx}{(x + \sqrt{x^2 + a^2})^n} = \frac{n}{a^{n-1}(n^2 - 1)} \quad [n \geq 2]$$

15.2 INTEGRANDS INVOLVING TRIGONOMETRIC FUNCTIONS

15.2.1

$$1. \int_0^{\pi} \sin mx \sin nx \, dx = 0 \quad [m, n \text{ integers}, m \neq n]$$

$$2. \int_0^{\pi} \cos mx \cos nx \, dx = 0 \quad [m, n \text{ integers}, m \neq n]$$

$$3. \int_0^{\pi} \sin mx \cos nx \, dx = \frac{m}{m^2 - n^2} [1 - (-1)^{m+n}] \quad [m, n \text{ integers}, m \neq n]$$

$$4. \int_0^{2\pi} \sin mx \sin nx \, dx = 0 \quad [m, n \text{ integers}, m \neq n]$$

$$5. \int_0^{2\pi} \sin^2 nx \, dx = \pi \quad [n \neq 0 \text{ integral}]$$

$$6. \int_0^{2\pi} \sin mx \cos nx \, dx = 0 \quad [m, n \text{ integers}]$$

$$7. \int_0^{2\pi} \cos mx \cos nx \, dx = \begin{cases} 0, & m \neq n \\ \pi, & m = n \neq 0 \\ 2\pi, & m = n = 0 \end{cases} \quad [m, n \text{ integers}]$$

$$8. \int_0^{\pi} \frac{\sin nx}{\sin x} \, dx = \begin{cases} 0, & n \text{ even} \\ \pi, & n \text{ odd} \end{cases}$$

$$9. \int_0^{\pi/2} \frac{\sin(2n-1)x}{\sin x} \, dx = \frac{\pi}{2}$$

$$10. \int_0^{\pi/2} \sin^{2m} x \, dx = \int_0^{\pi/2} \cos^{2m} x \, dx = \frac{(2m-1)!! \pi}{(2m)!! 2}$$

$$11. \int_0^{\pi/2} \sin^{2m+1} x \, dx = \int_0^{\pi/2} \cos^{2m+1} x \, dx = \frac{(2m)!!}{(2m+1)!!}$$

$$12. \int_0^{\infty} \frac{\sin ax}{\sqrt{x}} \, dx = \int_0^{\infty} \frac{\cos ax}{\sqrt{x}} \, dx = \sqrt{\frac{\pi}{2a}} \quad [a > 0]$$

$$13. \int_0^{\infty} \frac{\sin ax}{x} \, dx = \begin{cases} \frac{\pi}{2} \sin a, & a > 0 \\ 0, & a = 0 \end{cases}$$

$$14. \int_0^{\infty} \frac{\sin x \cos ax}{x} \, dx = \begin{cases} 0, & a^2 > 1 \\ \frac{\pi}{4}, & a = \pm 1 \\ \frac{\pi}{2}, & a^2 < 1 \end{cases}$$

$$15. \int_0^{2\pi} \frac{dx}{1+a \cos x} = \frac{2\pi}{\sqrt{1-a^2}} \quad [a^2 < 1]$$

$$16. \int_0^{\pi/2} \frac{dx}{1+a \cos x} = \frac{\arccos a}{\sqrt{1-a^2}} \quad [a^2 < 1]$$

$$17. \int_0^{\infty} \frac{\cos ax}{b^2+x^2} \, dx = \begin{cases} \frac{\pi}{2b} e^{-ab}, & a > 0, b > 0 \\ \frac{\pi}{2b} e^{ab}, & a < 0, b > 0 \end{cases}$$

$$18. \int_0^{\infty} \frac{\cos ax}{b^2-x^2} \, dx = \frac{\pi}{2b} \sin ab \quad [a > 0, b > 0]$$

$$19. \int_0^{\infty} \frac{x \sin ax}{b^2+x^2} \, dx = \frac{\pi}{2} e^{-ab} \quad [a > 0, b > 0]$$

$$20. \int_0^{\infty} \frac{x \sin ax}{b^2-x^2} \, dx = -\frac{\pi}{2} \cos ab \quad [a > 0]$$

$$21. \int_0^{\infty} \frac{\sin^2 x}{x^2} \, dx = \frac{\pi}{2}$$

$$22. \int_0^{\infty} \frac{\sin^2 ax}{x^2+b^2} \, dx = \frac{\pi}{4b} (1 - e^{-2ab}) \quad [a > 0, b > 0]$$

$$23. \int_0^{\infty} \frac{\cos^2 ax}{x^2+b^2} \, dx = \frac{\pi}{4b} (1 + e^{-2ab}) \quad [a > 0, b > 0]$$

$$24. \int_0^{\infty} \frac{\cos ax}{b^4 + x^4} dx = \frac{\pi\sqrt{2}}{4b^3} \exp\left(\frac{-ab}{\sqrt{2}}\right) \left(\cos \frac{ab}{\sqrt{2}} + \sin \frac{ab}{\sqrt{2}}\right) \quad [a > 0, b > 0]$$

$$25. \int_0^{\infty} \frac{\cos ax}{b^4 - x^4} dx = \frac{\pi}{4b^3} (e^{-ab} + \sin ab) \quad [a > 0, b > 0]$$

$$26. \int_0^{\pi/2} \frac{\cos^2 x dx}{1 - 2a \cos 2x + a^2} = \begin{cases} \frac{\pi}{4(1-a)}, & a^2 < 1 \\ \frac{\pi}{4(a-1)}, & a^2 > 1 \end{cases}$$

$$27. \int_0^{\infty} \frac{\cos ax dx}{(b^2 + x^2)(c^2 + x^2)} = \frac{\pi(be^{-ac} - ce^{-ab})}{2bc(b^2 - c^2)} \quad [a > 0, b > 0, c > 0]$$

$$28. \int_0^{\infty} \frac{x \sin ax dx}{(b^2 + x^2)(c^2 + x^2)} = \frac{\pi(e^{-ab} - e^{-ac})}{2(c^2 - b^2)} \quad [a > 0, b > 0, c > 0]$$

$$29. \int_0^{\infty} \frac{\cos ax dx}{(b^2 + x^2)^2} = \frac{\pi}{4b^3} (1 + ab)e^{-ab} \quad [a > 0, b > 0]$$

$$30. \int_0^{\infty} \frac{x \sin ax dx}{(b^2 + x^2)^2} = \frac{\pi}{4b} ae^{-ab} \quad [a > 0, b > 0]$$

$$31. \int_0^{\pi} \frac{\cos nx dx}{1 - 2a \cos x + a^2} = \begin{cases} \frac{\pi a^n}{1 - a^2}, & a^2 < 1 \\ \frac{\pi}{(a^2 - 1)a^n}, & a^2 > 1 \end{cases} \quad [n \geq 0 \text{ integral}]$$

$$32. \int_0^{\pi/2} \frac{\sin^2 x dx}{1 - 2a \cos 2x + a^2} = \frac{\pi}{4(1+a)} \quad [a^2 < 1]$$

$$33. \int_0^{\infty} \sin ax^2 dx = \int_0^{\infty} \cos ax^2 dx = \frac{1}{2} \sqrt{\frac{\pi}{2a}} \quad [a > 0] \quad (\text{see 14.1.1.1})$$

$$34. \int_0^{\infty} \sin ax^2 \cos 2bx dx = \frac{1}{2} \sqrt{\frac{\pi}{2a}} \left[\cos \frac{b^2}{a} - \sin \frac{b^2}{a} \right] \quad [a > 0, b \geq 0]$$

$$35. \int_0^{\infty} \cos ax^2 \cos 2bx dx = \frac{1}{2} \sqrt{\frac{\pi}{2a}} \left(\cos \frac{b^2}{a} + \sin \frac{b^2}{a} \right) \quad [a > 0, b > 0]$$

$$36. \int_0^{\pi} \cos(x \sin \theta) d\theta = \pi J_0(x)$$

$$37. \int_0^{\pi} \cos(n\theta - x \sin \theta) d\theta = \pi J_n(x)$$

15.3 INTEGRANDS INVOLVING THE EXPONENTIAL FUNCTION

15.3.1

1. $\int_0^{\infty} e^{-px} dx = \frac{1}{p} \quad [p > 0]$
2. $\int_0^{\infty} x^n e^{-px} dx = n!/p^{n+1} \quad [p > 0, n \text{ integral}]$
3. $\int_0^u x e^{-px} dx = \frac{1}{p^2} - \frac{1}{p^2} e^{-pu}(1 + pu) \quad [u > 0]$
4. $\int_0^u x^2 e^{-px} dx = \frac{2}{p^3} - \frac{1}{p^3} e^{-pu}(2 + 2pu - p^2 u^2) \quad [u > 0]$
5. $\int_0^u x^3 e^{-px} dx = \frac{6}{p^4} - \frac{1}{p^4} e^{-pu}(6 + 6pu + 3p^2 u^2 + p^3 u^3) \quad [u > 0]$
6. $\int_0^1 \frac{x e^x dx}{(1+x)^2} = \frac{1}{2} e - 1$
7. $\int_0^{\infty} x^{v-1} e^{-\mu x} dx = \frac{1}{\mu^v} \Gamma(v) \quad [\mu > 0, v > 0]$
8. $\int_0^{\infty} \frac{dx}{1 + e^{px}} = \frac{\ln 2}{p} \quad [p > 0]$
9. $\int_0^u \frac{e^{-qx}}{\sqrt{x}} dx = \sqrt{\frac{\pi}{q}} P(\sqrt{qu}) \quad [q > 0]$ (see 13.1.1.1.5)
10. $\int_0^{\infty} \frac{e^{-qx}}{\sqrt{x}} dx = \sqrt{\frac{\pi}{q}} \quad [q > 0]$
11. $\int_{-\infty}^{\infty} \frac{e^{-px}}{1 + e^{-qx}} dx = \frac{\pi}{q} \operatorname{cosec} \frac{p\pi}{q} \quad [q > p > 0 \text{ or } 0 > p > q]$
12. $\int_{-\infty}^{\infty} \frac{e^{-px}}{b - e^{-x}} dx = \pi b^{p-1} \cot p\pi \quad [b > 0, 0 < p < 1]$
13. $\int_{-\infty}^{\infty} \frac{e^{-px}}{b + e^{-x}} dx = \pi b^{p-1} \operatorname{cosec} p\pi \quad [b > 0, 0 < p < 1]$
14. $\int_1^{\infty} \frac{e^{-px}}{\sqrt{x-1}} dx = \sqrt{\frac{\pi}{p}} e^{-p} \quad [p > 0]$
15. $\int_0^{\infty} \frac{e^{-px}}{\sqrt{x+\beta}} dx = \sqrt{\frac{\pi}{p}} e^{\beta p} [1 - P(\beta p)] \quad [p > 0, \beta > 0]$ (see 13.1.1.1.5)

16. $\int_u^\infty \frac{e^{-px}}{x\sqrt{x-u}} dx = \frac{\pi}{\sqrt{u}}[1 - P(\sqrt{pu})]$ $[p \geq 0, u > 0]$ (see 13.1.1.1.5)
17. $\int_0^\infty \frac{xe^{-x}}{e^x - 1} dx = \frac{\pi^2}{6} - 1$
18. $\int_0^\infty \frac{xe^{-2x}}{e^{-x} + 1} dx = 1 - \frac{\pi^2}{12}$
19. $\int_0^\infty \frac{xe^{-3x}}{e^{-x} + 1} dx = \frac{\pi^2}{12} - \frac{3}{4}$
20. $\int_0^\infty \frac{x dx}{\sqrt{e^x - 1}} = 2\pi \ln 2$
21. $\int_0^\infty \frac{x^2 dx}{\sqrt{e^x - 1}} = 4\pi \left[(\ln 2)^2 + \frac{\pi^2}{12} \right]$
22. $\int_0^\infty \frac{xe^{-x}}{\sqrt{e^x - 1}} dx = \frac{\pi}{2}(2 \ln 2 - 1)$
23. $\int_0^1 \left(\frac{1}{\ln x} + \frac{1}{1-x} \right) dx = \gamma$ (see 11.1.1.1.7)
24. $\int_0^\infty \frac{1}{x} \left(\frac{1}{1+x^2} - e^{-x} \right) dx = \gamma$ (see 11.1.1.1.7)
25. $\int_0^\infty \left(\frac{1}{e^x - 1} - \frac{1}{xe^x} \right) dx = \gamma$ (see 11.1.1.1.7)
26. $\int_0^\infty x^{2n} e^{-px^2} dx = \frac{(2n-1)!!}{2(2p)^n} \sqrt{\frac{\pi}{p}}$
 $[p > 0, n = 0, 1, 2, \dots, (2n-1)!! = 1 \cdot 3 \cdot 5 \cdots (2n-1)]$
27. $\int_0^x x^{2n+1} e^{-px^2} dx = \frac{n!}{2p^{n+1}}$ $[p > 0, n = 0, 1, 2, \dots]$
28. $\int_0^x e^{-q^2 t^2} dt = \frac{\sqrt{\pi}}{2q} \operatorname{erf}(qx)$ $[q > 0]$ (see 13.2.1.1)
29. $\int_0^\infty e^{-q^2 t^2} dt = \frac{\sqrt{\pi}}{2q}$ $[q > 0]$
30. $\int_{-\infty}^\infty \exp(-p^2 x^2 \pm qx) dx = \exp\left(\frac{q^2}{4p^2}\right) \frac{\sqrt{\pi}}{p}$ $[p > 0]$

31. $\int x^p e^{-(qx)^2} dx = -\frac{x^{p-1}}{2q^2} e^{-(qx)^2} + \frac{(p-1)}{2q^2} \int x^{p-2} e^{-(qx)^2} dx \quad [p = 2, 3, \dots]$
32. $\int_0^u e^{-(qx)^2} dx = \frac{\sqrt{\pi} \operatorname{erf}(qu)}{2q}$
33. $\int_u^\infty e^{-(qx)^2} dx = \frac{\sqrt{\pi} (1 - e^{-(qu)^2})}{2q}$
34. $\int_0^u x e^{-(qx)^2} dx = \frac{1 - e^{-(qu)^2}}{2q^2}$
35. $\int_u^\infty x e^{-(qx)^2} dx = \frac{e^{-(qu)^2}}{2q^2}$
36. $\int_0^u x^2 e^{-(qx)^2} dx = \frac{[\sqrt{\pi} \operatorname{erf}(qu) - 2qu e^{-(qu)^2}]}{4q^3}$
37. $\int_u^\infty x^2 e^{-(qx)^2} dx = \frac{\sqrt{\pi} [\operatorname{erf}(qu) - 1] - 2qu e^{-(qu)^2}}{4q^3}$
38. $\int_0^u x^3 e^{-(qx)^2} dx = \frac{[1 - (1 + (qu)^2) e^{-(qu)^2}]}{2q^4}$
39. $\int_u^\infty x^3 e^{-(qx)^2} dx = \frac{[1 + (qu)^2] e^{-(qu)^2}}{2q^4}$
40. $\int_0^u x^4 e^{-(qx)^2} dx = \frac{[3\sqrt{\pi} \operatorname{erf}(qu) - 2(3qu + 2(qu)^3) e^{-(qu)^2}]}{8q^5}$
41. $\int_u^\infty x^4 e^{-(qx)^2} dx = \frac{3\sqrt{\pi} (1 - \operatorname{erf}(qu)) + 2(3qu + 2(qu)^3) e^{-(qu)^2}}{8q^5}$
42. $\int_0^\infty x^n e^{-(qx)^m} dx = \frac{1}{mq^{n+1}} \Gamma\left(\frac{n+1}{m}\right) \quad [m, n > 0, \text{ and real}]$
43. $\int_0^\infty x^{m/n} \exp(-(qx)^2) dx = \frac{1}{2q^{(m+n)/n}} \Gamma\left(\frac{m+n}{2n}\right) \quad [m, n > 0, \text{ and real}]$
44. $\int_0^\infty x^{m/n} \exp(-(qx)^p) dx = \frac{(q^p)^{[-(m+n)/(pn)]} \Gamma((m+n)/(pn))}{p} \quad [m, n, p > 0, \text{ and real}]$
45. $\int_0^\infty e^{-(qx)^2} \cos(mx) dx = \frac{\sqrt{\pi}}{2q} \exp(-m^2/(4q^2)) \quad [m \text{ real}]$

$$46. \int_0^{\infty} x e^{-(qx)^2} \sin(mx) dx = \frac{m\sqrt{\pi}}{4a^3} \exp(-m^2/(4q^2)) \quad [m \text{ real}]$$

$$47. \int_0^{\infty} x^2 e^{-(qx)^2} \cos(mx) dx = \frac{1}{8} \frac{\sqrt{\pi}(2q^2 - m^2)}{q^5} \quad [m \text{ real}]$$

$$48. \int_0^{\infty} x^3 e^{-(qx)^2} \sin(mx) dx = \frac{1}{16} \frac{\sqrt{\pi}(6q^2 - m^2)}{q^7} \exp(-m^2/(4q^2)) \quad [m \text{ real}]$$

15.4 INTEGRANDS INVOLVING THE HYPERBOLIC FUNCTION

15.4.1

$$1. \int_0^{\infty} \frac{dx}{\cosh ax} = \frac{\pi}{2a} \quad [a > 0]$$

$$2. \int_0^{\infty} \frac{\sinh ax}{\sinh bx} dx = \frac{\pi}{2b} \tan \frac{a\pi}{2b} \quad [b > |a|]$$

$$3. \int_0^{\infty} \frac{dx}{a + b \sinh x} = \frac{1}{\sqrt{a^2 + b^2}} \ln \left[\frac{a + b + \sqrt{a^2 + b^2}}{a + b - \sqrt{a^2 + b^2}} \right] \quad [ab \neq 0]$$

$$4. \int_0^{\infty} \frac{dx}{a + b \cosh x} = \frac{2}{\sqrt{b^2 - a^2}} \arctan \frac{\sqrt{b^2 - a^2}}{a + b} \quad [b^2 > a^2]$$

$$= \frac{1}{\sqrt{a^2 - b^2}} \ln \left[\frac{a + b + \sqrt{a^2 - b^2}}{a + b - \sqrt{a^2 - b^2}} \right] \quad [a^2 > b^2]$$

$$5. \int_0^{\infty} \frac{dx}{a \sinh x + b \cosh x} = \frac{2}{\sqrt{b^2 - a^2}} \arctan \frac{\sqrt{b^2 - a^2}}{a + b} \quad [b^2 > a^2]$$

$$= \frac{1}{\sqrt{a^2 - b^2}} \ln \left[\frac{a + b + \sqrt{a^2 - b^2}}{a + b - \sqrt{a^2 - b^2}} \right] \quad [a^2 > b^2]$$

15.5 INTEGRANDS INVOLVING THE LOGARITHMIC FUNCTION

15.5.1

$$1. \int_0^1 \frac{\ln x}{1-x} dx = -\frac{\pi^2}{6}$$

$$2. \int_0^1 \frac{\ln x}{1+x} dx = -\frac{\pi^2}{12}$$

$$3. \int_0^1 \frac{\ln(1+x)}{1+x^2} dx = \frac{\pi}{8} \ln 2$$

$$4. \int_0^1 (\ln x)^p dx = (-1)^p p! \quad [p = 0, 1, 2, \dots]$$

$$5. \int_0^1 x \ln(1+x) dx = \frac{1}{4}$$

$$6. \int_0^{\pi/2} \ln(\sin x) dx = \int_0^{\pi/2} \ln(\cos x) dx = -\frac{\pi}{2} \ln 2$$

$$7. \int_0^\pi \ln[1 + a \cos x]^2 dx = 2\pi \ln \left[\frac{1 + \sqrt{1 - a^2}}{2} \right] \quad [a^2 \leq 1]$$

or equivalently

$$\int_0^\pi \ln[1 + a \cos x] dx = \pi \ln \left[\frac{1 + \sqrt{1 - a^2}}{2} \right] \quad [a^2 \leq 1]$$

$$8. \int_0^\pi \ln[1 + a \cos x]^2 dx = \frac{\pi}{2} \ln \left(\frac{a^2}{4} \right) \quad [a^2 \geq 1]$$

Notice that, unlike case 7, this integrand cannot be rewritten as $2 \ln[1 + a \cos x]$, because $1 + a \cos x$ becomes negative in the interval of integration.

15.6 INTEGRANDS INVOLVING THE EXPONENTIAL INTEGRAL $Ei(x)$

$$1. \int x Ei(-ax) dx = \frac{x^2}{2} Ei(-ax) + \frac{1}{2a^2} e^{-ax} + \frac{x e^{-ax}}{2a} \quad [a > 0]$$

$$2. \int x^n Ei(-ax) dx = \frac{x^{n+1}}{n+1} Ei(-ax) + \frac{n! e^{-ax}}{(n+1)a^{n+1}} \sum_{k=0}^{\infty} \frac{(ax)^k}{k!} \quad [a > 0]$$

$$3. \int [Ei(-ax)]^2 dx = x[Ei(-ax)]^2 + \frac{2}{a} [Ei(-ax)e^{-ax} - Ei(-2ax)] \quad [a > 0]$$

$$4. \int x [Ei(-ax)]^2 dx = \frac{x^2}{2} [Ei(-ax)]^2 + \left(\frac{1}{a^2} + \frac{x}{a} \right) Ei(-ax) e^{-ax} \\ - \frac{1}{a^2} Ei(-2ax) + \frac{1}{2a^2} e^{-2ax} \quad [a > 0]$$

$$5. \int_0^u Ei(-ax) dx = u Ei(-au) + \frac{e^{-au} - 1}{a} \quad [a > 0]$$

$$6. \int_0^\infty x Ei(-x/a) Ei(-x/b) dx = \left(\frac{a^2 + b^2}{2} \right) \ln(a+b) - \frac{a^2}{2} \ln a - \frac{b^2}{2} \ln b - \frac{ab}{2} \quad [a > 0, b > 0]$$

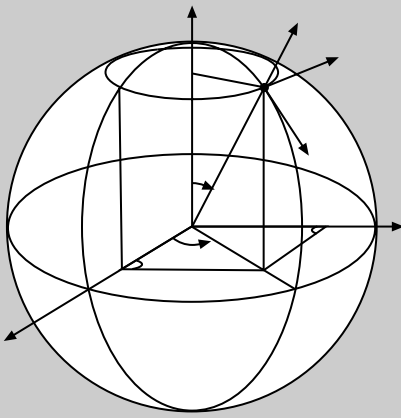

Chapter 16

Different Forms of Fourier Series

16.1 FOURIER SERIES FOR $f(x)$ ON $-\pi \leq x \leq \pi$

16.1.1 The Fourier Series

16.1.1.1

1.
$$\frac{1}{2}a_0 + \sum_{n=1}^{\infty} (a_n \cos nx + b_n \sin nx)$$

2. *Fourier coefficients*

$$a_0 = \frac{1}{\pi} \int_{-\pi}^{\pi} f(x) dx, \quad a_n = \frac{1}{\pi} \int_{-\pi}^{\pi} f(x) \cos nx \, dx \quad [n = 1, 2, \dots]$$

$$b_n = \frac{1}{\pi} \int_{-\pi}^{\pi} f(x) \sin nx \, dx \quad [n = 1, 2, \dots]$$

3. *Parseval relation*

$$\frac{1}{\pi} \int_{-\pi}^{\pi} [f(x)]^2 dx = \frac{1}{2}a_0^2 + \sum_{n=1}^{\infty} (a_n^2 + b_n^2)$$

If $f(x)$ is periodic with period 2π the Fourier series represents $f(x)$ for all x and these integrals may be evaluated over any interval of length 2π .

16.2 FOURIER SERIES FOR $f(x)$ ON $-L \leq x \leq L$

16.2.1 The Fourier Series

16.2.1.1

$$1. \quad \frac{1}{2}a_0 + \sum_{n=1}^{\infty} \left[a_n \cos\left(\frac{n\pi x}{L}\right) + b_n \sin\left(\frac{n\pi x}{L}\right) \right]$$

2. *Fourier coefficients*

$$a_0 = \frac{1}{L} \int_{-L}^L f(x) dx, \quad a_n = \frac{1}{L} \int_{-L}^L f(x) \cos\left(\frac{n\pi x}{L}\right) dx \quad [n = 1, 2, \dots]$$

$$b_n = \frac{1}{L} \int_{-L}^L f(x) \sin\left(\frac{n\pi x}{L}\right) dx \quad [n = 1, 2, \dots]$$

3. *Parseval relation*

$$\frac{1}{L} \int_{-L}^L [f(x)]^2 dx = \frac{1}{2}a_0^2 + \sum_{n=1}^{\infty} (a_n^2 + b_n^2)$$

If $f(x)$ is periodic with period $2L$ the Fourier series represents $f(x)$ for all x and these integrals may be evaluated over any interval of length $2L$.

16.3 FOURIER SERIES FOR $f(x)$ ON $a \leq x \leq b$

16.3.1 The Fourier Series

16.3.1.1

$$1. \quad \frac{1}{2}a_0 + \sum_{n=1}^{\infty} \left[a_n \cos\left(\frac{2n\pi x}{b-a}\right) + b_n \sin\left(\frac{2n\pi x}{b-a}\right) \right]$$

2. *Fourier coefficients*

$$a_0 = \frac{2}{b-a} \int_a^b f(x) dx, \quad a_n = \frac{2}{b-a} \int_a^b f(x) \cos\left(\frac{2n\pi x}{b-a}\right) dx \quad [n = 1, 2, \dots]$$

$$b_n = \frac{2}{b-a} \int_a^b f(x) \sin\left(\frac{2n\pi x}{b-a}\right) dx \quad [n = 1, 2, \dots]$$

3. *Parseval relation*

$$\frac{2}{b-a} \int_a^b [f(x)]^2 dx = \frac{1}{2}a_0^2 + \sum_{n=1}^{\infty} (a_n^2 + b_n^2)$$

If $f(x)$ is periodic with period $(b - a)$ the Fourier series represents $f(x)$ for all x and these integrals may be evaluated over any interval of length $(b - a)$.

16.4 HALF-RANGE FOURIER COSINE SERIES FOR $f(x)$ ON $0 \leq x \leq \pi$

16.4.1 The Fourier Series

16.4.1.1

- $\frac{1}{2}a_0 + \sum_{n=1}^{\infty} a_n \cos nx$

- Fourier coefficients*

$$a_0 = \frac{2}{\pi} \int_0^{\pi} f(x) dx, \quad a_n = \frac{2}{\pi} \int_0^{\pi} f(x) \cos nx dx \quad [n = 1, 2, \dots]$$

- Parseval relation*

$$\frac{2}{\pi} \int_0^{\pi} [f(x)]^2 dx = \frac{1}{2}a_0^2 + \sum_{n=1}^{\infty} a_n^2$$

If $f(x)$ is an even function, or it is extended to the interval $-\pi \leq x \leq 0$ as an even function so that $f(x) = f(-x)$, the Fourier series represents $f(x)$ on the interval $-\pi \leq x \leq \pi$.

16.5 HALF-RANGE FOURIER COSINE SERIES FOR $f(x)$ ON $0 \leq x \leq L$

16.5.1 The Fourier Series

16.5.1.1

- $\frac{1}{2}a_0 + \sum_{n=1}^{\infty} a_n \cos\left(\frac{n\pi x}{L}\right)$

- Fourier coefficients*

$$a_0 = \frac{2}{L} \int_0^L f(x) dx, \quad a_n = \frac{2}{L} \int_0^L f(x) \cos\left(\frac{n\pi x}{L}\right) dx \quad [n = 1, 2, \dots]$$

- Parseval relation*

$$\frac{2}{L} \int_0^L [f(x)]^2 dx = \frac{1}{2}a_0^2 + \sum_{n=1}^{\infty} a_n^2$$

If $f(x)$ is an even function, or it is extended to the interval $-L \leq x \leq 0$ as an even function so that $f(-x) = f(x)$, the Fourier series represents $f(x)$ on the interval $-L \leq x \leq L$.

16.6 HALF-RANGE FOURIER SINE SERIES FOR $f(x)$ ON $0 \leq x \leq \pi$

16.6.1 The Fourier Series

16.6.1.1

- $$\sum_{n=1}^{\infty} b_n \sin nx$$

- Fourier coefficients*

$$b_n = \frac{2}{\pi} \int_0^{\pi} f(x) \sin nx \, dx \quad [n = 1, 2, \dots]$$

- Parseval relation*

$$\frac{2}{\pi} \int_0^{\pi} [f(x)]^2 dx = \sum_{n=1}^{\infty} b_n^2$$

If $f(x)$ is an odd function, or it is extended to the interval $-\pi \leq x \leq 0$ as an odd function so that $f(-x) = -f(x)$, the Fourier series represents $f(x)$ on the interval $-\pi \leq x \leq \pi$.

16.7 HALF-RANGE FOURIER SINE SERIES FOR $f(x)$ ON $0 \leq x \leq L$

16.7.1 The Fourier Series

16.7.1.1

- $$\sum_{n=1}^{\infty} b_n \sin\left(\frac{n\pi x}{L}\right)$$

- Fourier coefficients*

$$b_n = \frac{2}{L} \int_0^L f(x) \sin\left(\frac{n\pi x}{L}\right) dx \quad [n = 1, 2, \dots]$$

- Parseval relation*

$$\frac{2}{L} \int_0^L [f(x)]^2 dx = \sum_{n=1}^{\infty} b_n^2$$

If $f(x)$ is an odd function, or it is extended to the interval $-L \leq x \leq 0$ as an odd function so that $f(-x) = -f(x)$, the Fourier series represents $f(x)$ on the interval $-L \leq x \leq L$.

16.8 COMPLEX (EXPONENTIAL) FOURIER SERIES FOR $f(x)$ **ON $-\pi \leq x \leq \pi$** **16.8.1 The Fourier Series****16.8.1.1**

$$1. \lim_{m \rightarrow \infty} \sum_{n=-m}^m c_n e^{inx}$$

2. *Fourier coefficients*

$$c_n = \frac{1}{2\pi} \int_{-\pi}^{\pi} f(x) e^{-inx} dx \quad [n = 0, \pm 1, \pm 2, \dots]$$

3. *Parseval relation*

$$\frac{1}{2\pi} \int_{-\pi}^{\pi} |f(x)|^2 dx = \lim_{m \rightarrow \infty} \sum_{n=-m}^m |c_n|^2$$

If $f(x)$ is periodic with period 2π the Fourier series represents $f(x)$ for all x and these integrals may be evaluated over any interval of length 2π .

16.9 COMPLEX (EXPONENTIAL) FOURIER SERIES FOR $f(x)$ **ON $-L \leq x \leq L$** **16.9.1 The Fourier Series****16.9.1.1**

$$1. \lim_{m \rightarrow \infty} \sum_{n=-m}^m c_n \exp[(in\pi x)/L]$$

2. *Fourier coefficients*

$$c_n = \frac{1}{2L} \int_{-L}^L f(x) \exp[-(in\pi x)/L] dx \quad [n = 0, \pm 1, \pm 2, \dots]$$

3. *Parseval relation*

$$\frac{1}{2L} \int_{-L}^L |f(x)|^2 dx = \lim_{m \rightarrow \infty} \sum_{n=-m}^m |c_n|^2.$$

If $f(x)$ is periodic with period $2L$ the Fourier series represents $f(x)$ for all x and these integrals may be evaluated over any interval of length $2L$.

16.10 REPRESENTATIVE EXAMPLES OF FOURIER SERIES

16.10.1

1. $f(x) = x \quad [-\pi \leq x \leq \pi]$

Fourier series

$$2 \sum_{n=1}^{\infty} \frac{(-1)^{n+1}}{n} \sin nx$$

Converges pointwise to $f(x)$ for $-\pi < x < \pi$.

Fourier coefficients

$$a_n = 0 \quad [n = 0, 1, 2, \dots]$$

$$b_n = \frac{2(-1)^{n+1}}{n} \quad [n = 1, 2, \dots]$$

Parseval relation

$$\frac{1}{\pi} \int_{-\pi}^{\pi} x^2 dx = \sum_{n=1}^{\infty} b_n^2 \quad \text{or} \quad \frac{\pi^2}{6} = \sum_{n=1}^{\infty} \frac{1}{n^2}$$

2. $f(x) = |x| \quad [-\pi \leq x \leq \pi]$

Fourier series

$$\frac{\pi}{2} - \frac{4}{\pi} \sum_{n=1}^{\infty} \frac{\cos(2n-1)x}{(2n-1)^2}$$

Converges pointwise to $f(x)$ for $-\pi \leq x \leq \pi$.

Fourier coefficients

$$a_0 = \pi, \quad a_{2n} = 0, \quad a_{2n-1} = \frac{-4}{\pi(2n-1)^2} \quad [n = 1, 2, \dots]$$

$$b_n = 0 \quad [n = 1, 2, \dots]$$

Parseval relation

$$\frac{1}{\pi} \int_{-\pi}^{\pi} |x|^2 dx = \frac{1}{2} a_0^2 + \sum_{n=1}^{\infty} a_n^2 \quad \text{or} \quad \frac{\pi^4}{96} = \sum_{n=1}^{\infty} \frac{1}{(2n-1)^4}$$

$$3. \quad f(x) = \begin{cases} -1, & -\pi \leq x < 0 \\ 1, & 0 < x \leq \pi \end{cases}$$

Fourier series

$$\frac{4}{\pi} \sum_{n=1}^{\infty} \frac{\sin(2n-1)x}{2n-1}$$

Converges pointwise to $f(x)$ for $-\pi < x < \pi$ and $x \neq 0$.

Fourier coefficients

$$a_n = 0 \quad [n = 0, 1, 2, \dots]$$

$$b_{2n} = 0, \quad b_{2n-1} = \frac{4}{\pi(2n-1)} \quad [n = 1, 2, \dots]$$

Parseval relation

$$\frac{1}{\pi} \int_{-\pi}^0 (-1)^2 dx + \frac{1}{\pi} \int_0^{\pi} 1^2 dx = \sum_{n=1}^{\infty} b_n^2 \quad \text{or} \quad \frac{\pi^2}{8} = \sum_{n=1}^{\infty} \frac{1}{(2n-1)^2}$$

$$4. \quad f(x) = |\sin x| \quad [-\pi \leq x \leq \pi]$$

Fourier series

$$\frac{2}{\pi} - \frac{4}{\pi} \sum_{n=1}^{\infty} \frac{\cos 2nx}{4n^2 - 1}$$

Converges pointwise to $f(x)$ for $-\pi \leq x \leq \pi$.

Fourier coefficients

$$a_0 = \frac{4}{\pi}, \quad a_{2n} = \frac{-4}{\pi(4n^2 - 1)}, \quad a_{2n-1} = 0 \quad [n = 1, 2, \dots]$$

Parseval relation

$$\frac{1}{\pi} \int_{-\pi}^{\pi} (\sin x)^2 dx = \frac{1}{2} a_0^2 + \sum_{n=1}^{\infty} a_n^2 \quad \text{or} \quad \frac{\pi^2}{16} = \frac{1}{2} + \sum_{n=1}^{\infty} \frac{1}{(4n^2 - 1)^2}$$

5. $f(x) = x^2 \quad [-\pi \leq x \leq \pi]$

Fourier series

$$\frac{\pi^2}{3} + 4 \sum_{n=1}^{\infty} \frac{(-1)^n}{n^2} \cos nx$$

Converges pointwise to $f(x)$ for $-\pi \leq x \leq \pi$.

Fourier coefficients

$$a_0 = \frac{2\pi^2}{3}, \quad a_n = \frac{4(-1)^n}{n^2} \quad [n = 1, 2, \dots]$$

$$b_n = 0 \quad [n = 1, 2, \dots]$$

Parseval relation

$$\frac{1}{\pi} \int_{-\pi}^{\pi} x^4 dx = \frac{1}{2} a_0^2 + \sum_{n=1}^{\infty} a_n^2 \quad \text{or} \quad \frac{\pi^4}{90} = \sum_{n=1}^{\infty} \frac{1}{n^4}$$

6. $f(x) = x^2 \quad [0 \leq x \leq 2\pi]$

Fourier series

$$\frac{4\pi^2}{3} + 4 \sum_{n=1}^{\infty} \left(\frac{1}{n^2} \cos nx - \frac{\pi}{n} \sin nx \right)$$

Converges pointwise to $f(x)$ for $0 < x < 2\pi$.

Fourier coefficients

$$a_0 = \frac{8\pi^2}{3}, \quad a_n = \frac{4}{n^2} \quad [n = 1, 2, \dots]$$

$$b_n = -\frac{4\pi}{n} \quad [n = 1, 2, \dots]$$

Parseval relation

$$\frac{1}{\pi} \int_0^{2\pi} x^4 dx = \frac{1}{2} a_0^2 + \sum_{n=1}^{\infty} (a_n^2 + b_n^2) \quad \text{or}$$

$$\frac{128\pi^4}{45} = 16 \sum_{n=1}^{\infty} \frac{1}{n^4} + 16\pi^2 \sum_{n=1}^{\infty} \frac{1}{n^2},$$

but from 16.10.1.5 above $\sum_{n=1}^{\infty} 1/n^4 = \pi^2/90$, so it follows that

$$\frac{\pi^2}{6} = \sum_{n=1}^{\infty} \frac{1}{n^2}.$$

7. $f(x) = x - x^2 \quad [0 \leq x \leq 1]$

Half-range Fourier cosine series

$$\frac{1}{6} - \frac{1}{\pi^2} \sum_{n=1}^{\infty} \frac{\cos 2n\pi x}{n^2}$$

Converges pointwise to $f(x)$ for $0 \leq x \leq 1$.

Half-range Fourier cosine series coefficients

$$a_0 = \frac{1}{3}, \quad a_n = \frac{-1}{\pi^2 n^2} \quad [n = 1, 2, \dots]$$

Parseval relation

$$2 \int_0^1 (x - x^2)^2 dx = \frac{1}{2} a_0^2 + \sum_{n=1}^{\infty} a_n^2 \quad \text{or} \quad \frac{\pi^4}{90} = \sum_{n=1}^{\infty} \frac{1}{n^4}$$

8. $f(x) = x - x^2 \quad [0 \leq x \leq 1]$

Half-range Fourier sine series

$$\frac{8}{\pi^3} \sum_{n=1}^{\infty} \frac{\sin(2n-1)\pi x}{(2n-1)^3}$$

Converges pointwise to $f(x)$ for $0 \leq x \leq 1$.

Half-range Fourier sine series coefficients

$$b_{2n} = 0 \quad [n = 1, 2, \dots]$$

$$b_{2n-1} = \frac{8}{\pi^2(2n-1)^3} \quad [n = 1, 2, \dots]$$

Parseval relation

$$2 \int_0^1 (x - x^2)^2 dx = \sum_{n=1}^{\infty} b_n^2 \quad \text{or} \quad \frac{\pi^6}{960} = \sum_{n=1}^{\infty} \frac{1}{(2n-1)^6}$$

9. $f(x) = e^{ax} \quad [-\pi \leq x \leq \pi]$

Complex Fourier series

$$\frac{\sinh \pi a}{\pi} \left[\lim_{m \rightarrow \infty} \sum_{n=-m}^m \left(\frac{1}{a - in} \right) e^{inx} \right]$$

Converges pointwise to $f(x)$ for $-\pi < x < \pi$.

Complex Fourier series coefficients

$$c_n = (-1)^n \frac{\sinh \pi a}{\pi} \left(\frac{1}{a - in} \right)$$

The complex Fourier series reduces to the real Fourier series

$$\frac{\sinh \pi a}{\pi a} + \frac{2 \sinh \pi a}{\pi} \sum_{n=1}^{\infty} (-1)^n \left[\left(\frac{a}{a^2 + n^2} \right) \cos nx - \left(\frac{n}{a^2 + n^2} \right) \sin nx \right],$$

which like the complex series converges pointwise to $f(x)$ for $-\pi < x < \pi$.

Parseval relation

$$\frac{1}{\pi} \int_{-\pi}^{\pi} e^{2ax} dx = \frac{1}{2} a_0^2 + \sum_{n=1}^{\infty} (a_n^2 + b_n^2)$$

with

$$a_0 = \frac{2 \sinh \pi a}{\pi a}, \quad a_n = \frac{(-1)^n a}{(a^2 + n^2)}, \quad b_n = \frac{(-1)^n n}{(a^2 + n^2)} \quad [n = 1, 2, \dots],$$

which yields

$$\frac{\pi \coth \pi a}{2a} - \frac{1}{2a^2} = \sum_{n=1}^{\infty} \frac{1}{(a^2 + n^2)}.$$

16.11 FOURIER SERIES AND DISCONTINUOUS FUNCTIONS

16.11.1 Periodic Extensions and Convergence of Fourier Series

16.11.1.1

Let $f(x)$ be defined on the interval $-\pi \leq x \leq \pi$. Then since each function in the Fourier series of $f(x)$ is periodic with a period that is a multiple of 2π , the Fourier series itself will be periodic with period 2π . Thus, irrespective of how $f(x)$ is defined outside the **fundamental interval** $-\pi \leq x \leq \pi$, the Fourier series will replicate the behavior of $f(x)$ in the intervals $(2n-1)\pi \leq x \leq (2n+1)\pi$, for $n = \pm 1, \pm 2, \dots$. Each of these intervals is called a **periodic extension** of $f(x)$.

At a point x_0 , a Fourier series, which is piecewise continuous with a finite number of jump discontinuities, converges to the number

$$1. \quad \frac{f(x_0 + 0) + f(x_0 - 0)}{2}.$$

Thus, if $f(x)$ is continuous at x_0 , the Fourier series converges to the number $f(x_0)$, while if it is discontinuous it follows from 16.11.1.1 that it converges to the average of $f(x_0 - 0)$ and $f(x_0 + 0)$. The periodicity of the Fourier series for $f(x)$ implies that these properties that are true in the fundamental interval $-\pi \leq x \leq \pi$ are also true in every periodic extension of $f(x)$.

In particular, if $f(-\pi) \neq f(\pi)$, there will be a jump discontinuity (a saltus) at each end of the fundamental interval (and at the ends of each periodic extension) where the Fourier series will converge to the value

$$\frac{1}{2}[f(\pi) + f(-\pi)].$$

These same arguments apply to Fourier series defined on an arbitrary interval $a \leq x \leq b$, and not only to the interval $-\pi \leq x \leq \pi$.

16.11.2 Applications to Closed-Form Summations of Numerical Series

16.11.2.1

The implications of 16.11.1.1 are best illustrated by means of examples that show how **closed-form summations** may be obtained for certain numerical series.

1. **Application to $f(x) = x$, $-\pi \leq x \leq \pi$.** From 16.10.1.1 the Fourier series of $f(x) = x$, $-\pi \leq x \leq \pi$ is known to be

$$2 \sum_{n=1}^{\infty} \frac{(-1)^{n+1}}{n} \sin nx.$$

A convenient choice of x will reduce this Fourier series to a simple numerical series. Let us choose $x = \pi/2$, at which point $f(x)$ is continuous and the Fourier series simplifies. At $x = \pi/2$ the Fourier series converges to $f(\pi/2) = \pi/2$. Using this result and setting $x = \pi/2$ in the Fourier series gives

$$\frac{\pi}{2} = 2 \sum_{n=1}^{\infty} \frac{(-1)^{n+1} \sin \frac{n\pi}{2}}{n}$$

or

$$\frac{\pi}{4} = \sum_{n=1}^{\infty} \frac{(-1)^{n+1}}{(2n-1)} = 1 - \frac{1}{3} + \frac{1}{5} - \dots$$

2. **Application to $f(x) = |\sin x|$, $-\pi \leq x \leq \pi$.** From 16.10.1.4 the Fourier series of $f(x) = |\sin x|$, $-\pi \leq x \leq \pi$ is known to be

$$\frac{2}{\pi} - \frac{4}{\pi} \sum_{n=1}^{\infty} \frac{\cos 2nx}{4n^2 - 1}$$

Because $f(x)$ is continuous and $f(-\pi) = f(\pi)$, it follows that the Fourier series converges to $f(x)$ for any choice of x in the interval $-\pi \leq x \leq \pi$, so let us set $x = 0$ at which point $f(0) = 0$. Then

$$0 = \frac{2}{\pi} - \frac{4}{\pi} \sum_{n=1}^{\infty} \frac{1}{4n^2 - 1}$$

or

$$\frac{1}{2} = \sum_{n=1}^{\infty} \frac{1}{4n^2 - 1} \quad (\text{see 1.8.3.3.3})$$

This result could have been obtained without appeal to Fourier series, because

$$\frac{1}{4n^2 - 1} = \frac{1}{2} \left[\frac{1}{2n-1} - \frac{1}{2n+1} \right],$$

so

$$\sum_{n=1}^{\infty} \frac{1}{4n^2 - 1} = \frac{1}{2} \sum_{n=1}^{\infty} \left[\frac{1}{2n-1} - \frac{1}{2n+1} \right] = \frac{1}{2} \left[\left(1 - \frac{1}{3}\right) + \left(\frac{1}{3} - \frac{1}{5}\right) + \left(\frac{1}{5} - \frac{1}{7}\right) + \dots \right].$$

After cancellation of terms (**telescoping of the series**) only the first term remains so the sum is seen to be $1/2$.

3. **Application to $f(x) = x - x^2$, $0 \leq x \leq 1$.** From 16.10.1.7 the Fourier series of $f(x) = x - x^2$, $0 \leq x \leq 1$ is known to be

$$\frac{1}{6} - \frac{1}{\pi^2} \sum_{n=1}^{\infty} \frac{\cos 2n\pi x}{n^2}.$$

Because $f(x)$ is continuous for $0 \leq x \leq 1$, it follows that at $x = 1/2$ the Fourier series will converge to $f(1/2) = 1/4$. Using this result and setting $x = 1/2$ in the Fourier series gives

$$\frac{1}{4} = \frac{1}{6} - \frac{1}{\pi^2} \sum_{n=1}^{\infty} \frac{\cos n\pi}{n^2}$$

or

$$\frac{1}{4} = \frac{1}{6} - \frac{1}{\pi^2} \sum_{n=1}^{\infty} \frac{(-1)^n}{n^2},$$

and so

$$\frac{\pi^2}{12} = \sum_{n=1}^{\infty} \frac{(-1)^{n+1}}{n^2} = 1 - \frac{1}{4} + \frac{1}{9} - \frac{1}{16} + \cdots.$$

4. **Application to $f(x) = e^{ax}$, $-\pi \leq x \leq \pi$.** From 16.10.1.9 it is known that $f(x) = e^{ax}$, $-\pi \leq x \leq \pi$ has the Fourier series

$$\frac{\sinh \pi a}{\pi a} + \frac{2 \sinh \pi a}{\pi} \sum_{n=1}^{\infty} (-1)^n \left[\left(\frac{a}{a^2 + n^2} \right) \cos nx - \left(\frac{n}{a^2 + n^2} \right) \sin nx \right].$$

The function $f(x)$ is continuous for $-\pi \leq x \leq \pi$, but $f(-\pi) \neq f(\pi)$. Thus, from 16.11.1.1.1, at the ends of the fundamental interval the Fourier series for $f(x)$ will converge to the value

$$\frac{1}{2} [f(\pi) + f(-\pi)] = \frac{1}{2} [e^{a\pi} + e^{-a\pi}] = \cosh \pi a.$$

Using this result and setting $x = \pi$ in the Fourier series gives

$$\cosh \pi a = \frac{\sinh \pi a}{\pi a} + \frac{2 \sinh \pi a}{\pi} \sum_{n=1}^{\infty} \left(\frac{a}{a^2 + n^2} \right),$$

where use has been made of the result $\cos n\pi = (-1)^n$. Thus

$$\coth \pi a = \frac{1}{\pi} \left[\frac{1}{a} + 2 \sum_{n=1}^{\infty} \frac{a}{a^2 + n^2} \right]$$

or, equivalently,

$$\frac{1}{2} \left[\pi \coth \pi a - \frac{1}{a} \right] = \sum_{n=1}^{\infty} \frac{a}{a^2 + n^2}.$$

Had the value $x = 0$ been chosen, at which point $f(x)$ is continuous, the Fourier series would have converged to $f(0) = 1$, and setting $x = 0$ in the Fourier series would have yielded

$$1 = \frac{\sinh \pi a}{\pi a} + \frac{2 \sinh \pi a}{\pi} \sum_{n=1}^{\infty} \frac{(-1)^n a}{a^2 + n^2},$$

from which it follows that

$$\frac{1}{2a} [1 - \pi a \operatorname{cosech} \pi a] = \sum_{n=1}^{\infty} \frac{(-1)^{n+1} a}{a^2 + n^2}.$$

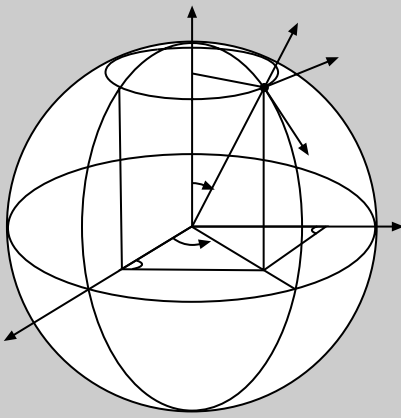

Chapter 17

Bessel Functions

17.1 BESSEL'S DIFFERENTIAL EQUATION

17.1.1 Different Forms of Bessel's Equation

17.1.1.1

In standard form, **Bessel's equation** is either written as

$$1. \quad x^2 \frac{d^2 y}{dx^2} + x \frac{dy}{dx} + (x^2 - \nu^2)y = 0$$

or as

$$2. \quad \frac{d^2 y}{dx^2} + \frac{1}{x} \frac{dy}{dx} + \left(1 - \frac{\nu^2}{x^2}\right)y = 0,$$

where the real parameter ν determines the nature of the two linearly independent solutions of the equation. By convention, ν is understood to be any real number that is *not* an integer, and when integral values of this parameter are involved ν is replaced by n .

Two linearly independent solutions of 17.1.1.1.1 are the **Bessel functions of the first kind of order ν** , written $J_\nu(x)$ and $J_{-\nu}(x)$. Another solution of 17.1.1.1.1, to which reference will be made later, is the **Bessel function of the second kind of order ν** , written $Y_\nu(x)$. The general solution of 17.1.1.1.1 is

$$3. \quad y = AJ_\nu(x) + BJ_{-\nu}(x) \quad [\nu \text{ not an integer}].$$

When the order is an integer ($\nu = n$) the Bessel functions $J_n(x)$ and $J_{-n}(x)$ cease to be linearly independent because

$$4. \quad J_{-n}(x) = (-1)^n J_n(x).$$

A second solution of Bessel's equation that is always linearly independent of $J_\nu(x)$ is $Y_\nu(x)$, irrespective of the value of ν . Thus, the general solution of 17.1.1.1.1 may always be written

$$5. \quad y = AJ_\nu(x) + BY_\nu(x).$$

Take note of the fact that in many books the Bessel function $Y_\nu(x)$ of the second kind is called the **Neumann function** and is denoted by $N_\nu(x)$.

The Bessel function of the second kind $Y_\nu(x)$ is defined as

$$6. \quad Y_\nu(x) = \frac{J_\nu(x) \cos(\nu\pi) - J_{-\nu}(x)}{\sin(\nu\pi)},$$

and when ν is an integer n or zero,

$$7. \quad Y_n(x) = \lim_{\nu \rightarrow n} Y_\nu(x).$$

A more general form of Bessel's equation that arises in many applications is

$$8. \quad x^2 \frac{d^2 y}{dx^2} + x \frac{dy}{dx} + (\lambda^2 x^2 - \nu^2)y = 0$$

or, equivalently,

$$9. \quad \frac{d^2 y}{dx^2} + \frac{1}{x} \frac{dy}{dx} + \left(\lambda^2 - \frac{\nu^2}{x^2} \right) y = 0.$$

These forms may be derived from 17.1.1.1.1 by first making the change of variable $x = \lambda u$, and then replacing u by x . Bessel's equations 17.1.1.1.8–9 always have the general solution

$$10. \quad y = AJ_\nu(\lambda x) + BY_\nu(\lambda x).$$

17.2 SERIES EXPANSIONS FOR $J_\nu(x)$ AND $Y_\nu(x)$

17.2.1 Series Expansions for $J_n(x)$ and $J_\nu(x)$

17.2.1.1

$$1. \quad J_0(x) = \sum_{k=0}^{\infty} \frac{(-1)^k x^{2k}}{2^{2k} (k!)^2}$$

$$= 1 - \frac{x^2}{2^2 (1!)^2} + \frac{x^4}{2^4 (2!)^2} - \frac{x^6}{2^6 (3!)^2} + \cdots$$

2.
$$J_1(x) = \sum_{k=0}^{\infty} \frac{(-1)^k x^{2k+1}}{2^{2k+1} k! (k+1)!}$$

$$= \frac{x}{2} - \frac{x^3}{2^3 1! 2!} + \frac{x^5}{2^5 2! 3!} - \frac{x^7}{2^7 3! 4!} + \cdots$$
3.
$$J_2(x) = \frac{x^2}{4} \left[\frac{1}{2!} - \frac{x^2}{2^2 1! 3!} + \frac{x^4}{2^4 2! 4!} - \frac{x^6}{2^6 3! 5!} + \cdots \right].$$
4.
$$J_n(x) = x^n \sum_{k=0}^{\infty} \frac{(-1)^k x^{2k}}{2^{2k+n} k! (n+k)!}.$$
5.
$$J_{-n}(x) = x^n \sum_{k=0}^{\infty} \frac{(-1)^{n+k} x^{2k}}{2^{2k+n} k! (n+k)!}.$$
6.
$$J_\nu(x) = x^\nu \sum_{k=0}^{\infty} \frac{(-1)^k x^{2k}}{2^{2k+\nu} k! \Gamma(\nu+k+1)}.$$

17.2.1.2 Special Values

1. $J_0(0) = 1, \quad J_n(0) = 0 \quad [n = 1, 2, 3, \dots]$
2. $J'_0(0) = 0, \quad J'_1(0) = \frac{1}{2}, \quad J'_n(0) = 0 \quad [n = 2, 3, 4, \dots]$
3. $\lim_{x \rightarrow \infty} J_n(x) = 0, \quad [n = 0, 1, 2, \dots]$

17.2.2 Series Expansions for $Y_n(x)$ and $Y_\nu(x)$

17.2.2.1

1.
$$Y_0(x) = \frac{2}{\pi} \left\{ \left(\ln \frac{x}{2} + \gamma \right) J_0(x) + \sum_{k=1}^{\infty} \frac{(-1)^{(k-1)}}{2^{2k} (k!)^2} \left[1 + \frac{1}{2} + \frac{1}{3} + \cdots + \frac{1}{k} \right] x^{2k} \right\}$$

[$\gamma = 0.577215\dots$] (see 11.1.1.1.7)
2.
$$Y_1(x) = \frac{2}{\pi} \left(\ln \frac{x}{2} + \gamma \right) J_1(x) - \frac{2}{\pi x} - \frac{1}{\pi} \sum_{k=1}^{\infty} \frac{(-1)^{(k+1)}}{2^{2k-1} (k!) (k-1)!}$$

$$\times \left[\frac{1}{k} + 2 \sum_{m=1}^{k-1} \frac{1}{m} \right] x^{2k-1} \quad [\gamma = 0.577215\dots] \quad (\text{see 11.1.1.1.7})$$

$$3. \quad Y_n(x) = -\frac{\left(\frac{1}{2}x\right)^{-n}}{\pi} \sum_{k=0}^{n-1} \frac{(n-k-1)!}{k!} \left(\frac{1}{4}x^2\right)^k + \frac{2}{\pi} \ln \frac{x}{2} J_n(x) \\ - \frac{\left(\frac{1}{2}x\right)^n}{\pi} \sum_{k=0}^{\infty} \{\psi(k+1) + \psi(n+k+1)\} \frac{\left(-\frac{1}{4}x^2\right)^k}{k!(n+k)!}$$

[with $\psi(k)$ given by 11.1.6.1.6]

$$4. \quad Y_\nu(x) = \frac{1}{\sin(\nu\pi)} \left\{ \cos(\nu\pi) \left(\frac{x}{2}\right)^\nu \sum_{k=0}^{\infty} \frac{(-1)^k x^{2k}}{2^{2k} k! \Gamma(\nu+k+1)} \right. \\ \left. - \left(\frac{x}{2}\right)^{-\nu} \sum_{k=0}^{\infty} \frac{(-1)^k x^{2k}}{2^{2k} k! \Gamma(k-\nu+1)} \right\} \quad [\nu \text{ not an integer}].$$

17.2.2.2 Special Values

$$1. \quad \lim_{x \rightarrow 0} Y_n(x) = -\infty \quad [n = 0, 1, 2, \dots]$$

$$2. \quad \lim_{x \rightarrow \infty} Y_n(x) = 0 \quad [n = 0, 1, 2, \dots]$$

17.2.3 Expansion of $\sin(x \sin \theta)$ and $\cos(x \sin \theta)$ in Terms of Bessel Functions

$$1. \quad \sin(x \sin \theta) = 2 \sum_{n=1}^{\infty} J_{2n-1}(x) \sin[(2n-1)\theta]$$

$$2. \quad \cos(x \sin \theta) = J_0(x) + 2 \sum_{n=1}^{\infty} J_{2n}(x) \cos(2n\theta)$$

17.3 BESSEL FUNCTIONS OF FRACTIONAL ORDER

17.3.1 Bessel Functions $J_{\pm(n+1/2)}(x)$

17.3.1.1

$$1. \quad J_{1/2}(x) = \sqrt{\frac{2}{\pi x}} \sin x$$

$$2. \quad J_{-1/2}(x) = \sqrt{\frac{2}{\pi x}} \cos x$$

$$3. \quad J_{3/2}(x) = \sqrt{\frac{2}{\pi x}} \left(\frac{\sin x}{x} - \cos x \right)$$

$$4. J_{-3/2}(x) = -\sqrt{\frac{2}{\pi x}} \left(\frac{\cos x}{x} + \sin x \right)$$

$$5. J_{5/2}(x) = \sqrt{\frac{2}{\pi x}} \left[\left(\frac{3}{x^2} - 1 \right) \sin x - \frac{3}{x} \cos x \right]$$

$$6. J_{-5/2}(x) = \sqrt{\frac{2}{\pi x}} \left[\left(\frac{3}{x^2} - 1 \right) \cos x + \frac{3}{x} \sin x \right]$$

$$7. J_{n+1/2}(x) = \frac{2 \left(\frac{1}{2}x \right)^{n+1/2}}{\sqrt{\pi n!}} \left[\left(1 + \frac{d^2}{dx^2} \right)^n \frac{\sin x}{x} \right]$$

$$8. J_{-(n+1/2)}(x) = (-1)^{n+1} Y_{n+1/2}(x) \quad (\text{see 17.3.2.1.7})$$

17.3.2 Bessel Functions $Y_{\pm(n+1/2)}(x)$

17.3.2.1

$$1. Y_{1/2}(x) = -\sqrt{\frac{2}{\pi x}} \cos x$$

$$2. Y_{-1/2}(x) = \sqrt{\frac{2}{\pi x}} \sin x$$

$$3. Y_{3/2}(x) = -\sqrt{\frac{2}{\pi x}} \left(\frac{\cos x}{x} + \sin x \right)$$

$$4. Y_{-3/2}(x) = \sqrt{\frac{2}{\pi x}} \left(-\frac{\sin x}{x} + \cos x \right)$$

$$5. Y_{5/2}(x) = -\sqrt{\frac{2}{\pi x}} \left[\left(\frac{3}{x^2} - 1 \right) \cos x + \frac{3}{x} \sin x \right]$$

$$6. Y_{-5/2}(x) = \sqrt{\frac{2}{\pi x}} \left[\left(\frac{3}{x^2} - 1 \right) \sin x - \frac{3}{x} \cos x \right]$$

$$7. Y_{n+1/2}(x) = -\frac{2 \left(\frac{1}{2}x \right)^{n+1/2}}{\sqrt{\pi n!}} \left\{ \left(1 + \frac{d^2}{dx^2} \right)^n \frac{\cos x}{x} \right\}$$

$$8. Y_{-(n+1/2)}(x) = (-1)^n J_{n+1/2}(x) \quad (\text{see 17.3.1.1.7})$$

17.4 ASYMPTOTIC REPRESENTATIONS FOR BESSEL FUNCTIONS

17.4.1 Asymptotic Representations for Large Arguments

17.4.1.1

$$1. J_\nu(x) \sim \sqrt{\frac{2}{\pi x}} \left[\cos \left(x - \frac{1}{2}\nu\pi - \frac{1}{4}\pi \right) \right] \quad [x \gg 0]$$

$$2. Y_\nu(x) \sim \sqrt{\frac{2}{\pi x}} \left[\sin \left(x - \frac{1}{2}\nu\pi - \frac{1}{4}\pi \right) \right] \quad [x \gg 0]$$

17.4.2 Asymptotic Representation for Large Orders

17.4.2.1

$$1. J_\nu(x) \sim \frac{1}{\sqrt{2\pi\nu}} \left(\frac{ex}{2\nu} \right)^\nu \quad [\nu \gg 0]$$

$$2. Y_\nu(x) \sim -\sqrt{\frac{2}{\pi\nu}} \left(\frac{ex}{2\nu} \right)^{-\nu} \quad [\nu \gg 0]$$

17.5 ZEROS OF BESSEL FUNCTIONS

17.5.1 Zeros of $J_n(x)$ and $Y_n(x)$

17.5.1.1

Denote the zeros of $J_n(x)$ arranged in order of increasing magnitude by $j_{n,1}, j_{n,2}, j_{n,3}, \dots$, and those of $Y_n(x)$ when similarly ordered by $y_{n,1}, y_{n,2}, y_{n,3}, \dots$. Then the zeros of successive orders of Bessel functions of the first kind interlace, as do those of Bessel functions of the second kind, in the sense that

$$1. j_{n-1,m} < j_{n,m} < j_{n-1,m+1} \quad [n, m = 1, 2, \dots]$$

$$2. y_{n-1,m} < y_{n,m} < y_{n-1,m+1} \quad [n, m = 1, 2, \dots]$$

Table 17.1 lists the zeros $j_{n,m}$ and $y_{n,m}$ for $n = 0, 1, 2$ and $m = 1, 2, \dots, 10$. Figure 17.1 shows the behavior of $J_n(x)$ and Figure 17.2 the behavior of $Y_n(x)$ for $n = 0, 1, 2$ and $0 \leq x \leq 10$.

17.6 BESSEL'S MODIFIED EQUATION

17.6.1 Different Forms of Bessel's Modified Equation

17.6.1.1

In standard form, Bessel's modified equation is either written as

$$1. x^2 \frac{d^2 y}{dx^2} + x \frac{dy}{dx} - (x^2 + \nu^2) y = 0$$

or as

$$2. \quad \frac{d^2 y}{dx^2} + \frac{1}{x} \frac{dy}{dx} - \left(1 + \frac{\nu^2}{x^2}\right) y = 0,$$

where the real parameter ν determines the nature of the two linearly independent solutions of the equation. As in 17.1.1, by convention ν is understood to be any real number that is *not* an integer, and when integral values of this parameter are involved ν is replaced by n .

Table 17.1. Zeros $j_{n,m}$ and $y_{n,m}$

m	$j_{0,m}$	$j_{1,m}$	$j_{2,m}$	$y_{0,m}$	$y_{1,m}$	$y_{2,m}$
1	2.40483	3.83171	5.13562	0.89358	2.19714	3.38424
2	5.52008	7.01559	8.41724	3.95768	5.42968	6.79381
3	8.65373	10.17347	11.61984	7.08605	8.59601	10.02348
4	11.79153	13.32369	14.79595	10.22235	11.74915	13.20999
5	14.93092	16.47063	17.95982	13.36110	14.89744	16.37897
6	18.07106	19.61586	21.11700	16.50092	18.04340	19.53904
7	21.21164	22.76008	24.27011	19.64131	21.18807	22.69396
8	24.35247	25.90367	27.42057	22.78203	24.33194	25.84561
9	27.49348	29.04683	30.56920	25.92296	27.47529	28.99508
10	30.63461	32.18968	33.71652	29.06403	30.61829	32.14300

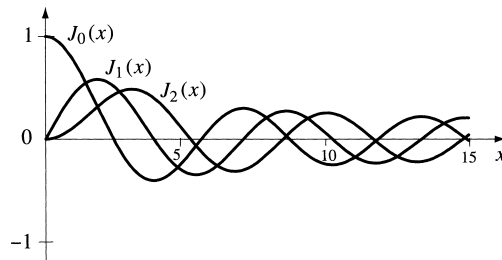

Figure 17.1.

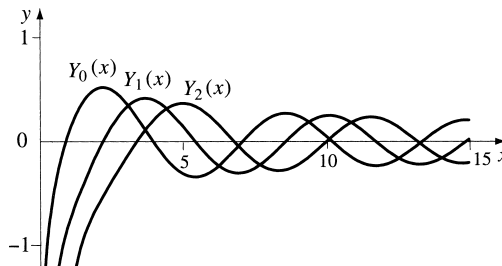

Figure 17.2.

Two linearly independent solutions of 17.6.1.1.1 are the **modified Bessel functions of the first kind of order ν** , written $I_\nu(x)$ and $I_{-\nu}(x)$. Another solution of 17.6.1.1.1, to which reference will be made later, is the **modified Bessel function of the second kind of order ν** , written $K_\nu(x)$.

The general solution of 17.6.1.1.1 is

$$3. \quad y = AI_\nu(x) + BI_{-\nu}(x) \quad [\nu \text{ not an integer}].$$

When the order is an integer ($\nu = n$), the modified Bessel functions $I_n(x)$ and $I_{-n}(x)$ cease to be linearly independent because

$$4. \quad I_{-n}(x) = I_n(x).$$

A second solution of 17.6.1.1.1 that is always linearly independent of $I_\nu(x)$ is $K_\nu(x)$, irrespective of the value of ν . Thus, the general solution of 17.6.1.1.1 can always be written

$$5. \quad y = AI_\nu(x) + BK_\nu(x).$$

The modified Bessel function of the second kind $K_\nu(x)$ is defined as

$$6. \quad K_\nu(x) = \frac{\pi}{2} \frac{I_{-\nu}(x) - I_\nu(x)}{\sin(\nu\pi)},$$

and when ν is an integer n or zero,

$$7. \quad K_n(x) = \lim_{\nu \rightarrow n} K_\nu(x).$$

A more general form of Bessel's modified equation that arises in many applications is

$$8. \quad x^2 \frac{d^2 y}{dx^2} + x \frac{dy}{dx} - (\lambda^2 x^2 + \nu^2) y = 0$$

or, equivalently,

$$9. \quad \frac{d^2 y}{dx^2} + \frac{1}{x} \frac{dy}{dx} - \left(\lambda^2 + \frac{\nu^2}{x^2} \right) y = 0.$$

These forms may be derived from 17.6.1.1.1 by first making the change of variable $x = \lambda u$, and then replacing u by x . Bessel's modified equations 17.6.1.1.8–9 always have the general solution

$$10. \quad y = AI_\nu(\lambda x) + BK_\nu(\lambda x).$$

11. Figure 17.3 shows the behavior of $I_n(x)$ and $K_n(x)$ for $n = 0, 1$ and $0 \leq x \leq 4$.

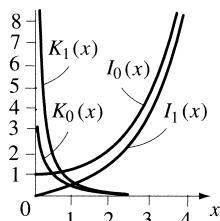

Figure 17.3.

17.7 SERIES EXPANSIONS FOR $I_\nu(x)$ AND $K_\nu(x)$

17.7.1 Series Expansions for $I_n(x)$ and $I_\nu(x)$

17.7.1.1

$$1. \quad I_0(x) = \sum_{k=0}^{\infty} \frac{x^{2k}}{2^{2k} (k!)^2} = 1 + \frac{x^2}{2^2 (1!)^2} + \frac{x^4}{2^4 (2!)^2} + \frac{x^6}{2^6 (3!)^2} + \cdots$$

$$2. \quad I_1(x) = \sum_{k=0}^{\infty} \frac{x^{2k+1}}{2^{2k+1} k! (k+1)!}$$

$$= \frac{x}{2} + \frac{x^3}{2^3 1! 2!} + \frac{x^5}{2^5 2! 3!} + \frac{x^7}{2^7 3! 4!} + \cdots$$

$$3. \quad I_n(x) = \sum_{k=0}^{\infty} \frac{x^{n+2k}}{2^{n+2k} k! (n+k)!}$$

$$4. \quad I_\nu(x) = i^{-\nu} J_\nu(ix) = \sum_{k=0}^{\infty} \frac{x^{\nu+2k}}{2^{\nu+2k} k! \Gamma(\nu+k+1)}$$

$$5. \quad I_{-\nu}(x) = \sum_{k=0}^{\infty} \frac{x^{2k-\nu}}{2^{2k-\nu} k! \Gamma(k+1-\nu)}$$

17.7.1.2

$$1. \quad I_0(0) = 1, \quad I_n(0) = 0 \quad [n = 1, 2, \dots]$$

$$2. \quad \lim_{x \rightarrow \infty} I_n(x) = \infty \quad [n = 0, 1, 2, \dots]$$

17.7.2 Series Expansions for $K_0(x)$ and $K_n(x)$

17.7.2.1

$$1. \quad K_0(x) = -\left[\ln \frac{x}{2} + \gamma\right] I_0(x) + \frac{\frac{1}{4}x^2}{1!} + \left(1 + \frac{1}{2}\right) \frac{\left(\frac{1}{4}x^2\right)^2}{(2!)^2} + \left(1 + \frac{1}{2} + \frac{1}{3}\right) \frac{\left(\frac{1}{4}x^2\right)^3}{3!^2} \dots$$

[$\gamma = 0.577215\dots$] (see 11.1.1.1.7)

$$2. \quad K_n(x) = \frac{1}{2} \left(\frac{x}{2}\right)^{-n} \sum_{k=0}^{n-1} \frac{(n-k-1)!}{k!} \left(-\frac{1}{4}x^2\right)^k + (-1)^{n+1} \ln\left(\frac{x}{2}\right) I_n(x) + (-1)^n \frac{1}{2} \left(\frac{x}{2}\right)^n$$

$$\times \sum_{k=0}^{\infty} [\psi(k+1) + \psi(n+k+1)] \frac{\left(-\frac{1}{4}x^2\right)^k}{k!(n+k)!} \quad [\text{with } \psi(k) \text{ given by 11.1.6.1.6}]$$

$$3. \quad K_{-n}(x) = K_n(x) \quad [n = 0, 1, 2, \dots]$$

17.7.2.2 Special Cases

$$1. \quad \lim_{x \rightarrow 0} K_n(x) = \infty \quad [n = 0, 1, 2, \dots]$$

$$2. \quad \lim_{x \rightarrow \infty} K_n(x) = 0 \quad [n = 0, 1, 2, \dots]$$

17.8 MODIFIED BESSEL FUNCTIONS OF FRACTIONAL ORDER

17.8.1 Modified Bessel Functions $I_{\pm(n+1/2)}(x)$

17.8.1.1

$$1. \quad I_{1/2}(x) = \sqrt{\frac{2}{\pi x}} \sinh x$$

$$2. \quad I_{-1/2}(x) = \sqrt{\frac{2}{\pi x}} \cosh x$$

$$3. \quad I_{3/2}(x) = -\sqrt{\frac{2}{\pi x}} \left(\frac{\sinh x}{x} - \cosh x\right)$$

$$4. \quad I_{-3/2}(x) = -\sqrt{\frac{2}{\pi x}} \left(\frac{\cosh x}{x} - \sinh x\right)$$

$$5. \quad I_{5/2}(x) = \sqrt{\frac{2}{\pi x}} \left[\left(\frac{3}{x^2} + 1\right) \sinh x - \frac{3}{x} \cosh x\right]$$

$$6. \quad I_{-5/2}(x) = \sqrt{\frac{2}{\pi x}} \left[\left(\frac{3}{x^2} + 1\right) \cosh x - \frac{3}{x} \sinh x\right]$$

$$7. \quad I_{n+1/2}(x) = \frac{1}{\sqrt{2\pi x}} \left[e^x \sum_{k=0}^n \frac{(-1)^k (n+k)!}{k! (n-k)! (2x)^k} + (-1)^{n+1} e^{-x} \sum_{k=0}^n \frac{(n+k)!}{k! (n-k)! (2x)^k} \right]$$

$$8. \quad I_{-(n+1/2)}(x) = \frac{1}{\sqrt{2\pi x}} \left[e^x \sum_{k=0}^n \frac{(-1)^k (n+k)!}{k! (n-k)! (2x)^k} + (-1)^n e^{-x} \sum_{k=0}^n \frac{(n+k)!}{k! (n-k)! (2x)^k} \right]$$

17.8.2 Modified Bessel Functions $K_{\pm(n+1/2)}(x)$

17.8.2.1

1. $K_{1/2}(x) = e^{-x} \sqrt{\frac{\pi}{2x}}$
2. $K_{3/2}(x) = e^{-x} \sqrt{\frac{\pi}{2x}} \left(\frac{1}{x} + 1 \right)$
3. $K_{5/2}(x) = e^{-x} \sqrt{\frac{\pi}{2x}} \left(\frac{3}{x^2} + \frac{3}{x} + 1 \right)$
4. $K_{n+1/2}(x) = \sqrt{\frac{\pi}{2x}} e^{-x} \sum_{k=0}^n \frac{(n+k)!}{2^k k! (n-k)! x^k}$
5. $K_{-(n+1/2)}(x) = K_{n+1/2}(x)$

17.9 ASYMPTOTIC REPRESENTATIONS OF MODIFIED BESSEL FUNCTIONS

17.9.1 Asymptotic Representations for Large Arguments

17.9.1.1

1. $I_\nu(x) \sim \frac{e^x}{\sqrt{2\pi x}} \left[1 - \frac{4\nu^2 - 1}{8x} \right] \quad [x \gg 0]$
2. $K_\nu(x) \sim \sqrt{\frac{\pi}{2x}} e^{-x} \left[1 + \frac{4\nu^2 - 1}{8x} \right] \quad [x \gg 0]$

17.10 RELATIONSHIPS BETWEEN BESSEL FUNCTIONS

17.10.1 Relationships Involving $J_\nu(x)$ and $Y_\nu(x)$

17.10.1.1

1. $J_2(x) = \frac{2}{x} J_1(x) - J_0(x)$
2. $Y_2(x) = \frac{2}{x} Y_1(x) - Y_0(x)$
3. $\frac{d}{dx} [J_0(x)] = -J_1(x)$

4. $\frac{d}{dx} [Y_0(x)] = -Y_1(x)$
5. $x J_{\nu-1}(x) + x J_{\nu+1}(x) = 2\nu J_\nu(x)$
6. $x Y_{\nu-1}(x) + x Y_{\nu+1}(x) = 2\nu Y_\nu(x)$
7. $J_{\nu-1}(x) - J_{\nu+1}(x) = 2 \frac{d}{dx} [J_\nu(x)]$
8. $Y_{\nu-1}(x) - Y_{\nu+1}(x) = 2 \frac{d}{dx} [Y_\nu(x)]$
9. $x \frac{d}{dx} [J_\nu(x)] + \nu J_\nu(x) = x J_{\nu-1}(x)$
10. $x \frac{d}{dx} [Y_\nu(x)] + \nu Y_\nu(x) = x Y_{\nu-1}(x)$
11. $x \frac{d}{dx} [J_\nu(x)] - \nu J_\nu(x) = -x J_{\nu+1}(x)$
12. $x \frac{d}{dx} [Y_\nu(x)] - \nu Y_\nu(x) = -x Y_{\nu+1}(x)$
13. $\left(\frac{1}{x} \frac{d}{dx}\right)^m [x^\nu J_\nu(x)] = x^{\nu-m} J_{\nu-m}(x)$
14. $\left(\frac{1}{x} \frac{d}{dx}\right)^m [x^\nu Y_\nu(x)] = x^{\nu-m} Y_{\nu-m}(x)$
15. $\left(\frac{1}{x} \frac{d}{dx}\right)^m [x^{-\nu} J_\nu(x)] = (-1)^m x^{-\nu-m} J_{\nu+m}(x)$
16. $\left(\frac{1}{x} \frac{d}{dx}\right)^m [x^{-\nu} Y_\nu(x)] = (-1)^m x^{-\nu-m} Y_{\nu+m}(x)$
17. $J_{-n}(x) = (-1)^n J_n(x) \quad [n \text{ an integer}]$
18. $Y_{-n}(x) = (-1)^n Y_n(x) \quad [n \text{ an integer}]$
19. $\frac{d}{dx} [x^n J_n(x)] = x^n J_{n-1}(x)$
20. $\frac{d}{dx} [x^n Y_n(x)] = x^n Y_{n-1}(x)$

$$21. \quad J_n(x+y) = \sum_{k=-\infty}^{\infty} J_k(x) J_{n-k}(y) \quad (n = 0, \pm 1, \pm 2, \dots)$$

17.10.2 Relationships Involving $I_\nu(x)$ and $K_\nu(x)$

17.10.2.1

1. $x I_{\nu-1}(x) - x I_{\nu+1}(x) = 2\nu I_\nu(x)$
2. $I_{\nu-1}(x) + I_{\nu+1}(x) = 2 \frac{d}{dx} [I_\nu(x)]$
3. $x \frac{d}{dx} [I_\nu(x)] + \nu I_\nu(x) = x I_{\nu-1}(x)$
4. $x \frac{d}{dx} [I_\nu(x)] - \nu I_\nu(x) = x I_{\nu+1}(x)$
5. $\left(\frac{1}{x} \frac{d}{dx}\right)^m [x^\nu I_\nu(x)] = x^{\nu-m} I_{\nu-m}(x)$
6. $\left(\frac{1}{x} \frac{d}{dx}\right)^m [x^{-\nu} I_\nu(x)] = x^{-\nu-m} I_{\nu+m}(x)$
7. $I_{-n}(x) = I_n(x) \quad [n \text{ an integer}]$
8. $I_2(x) = -\frac{2}{x} I_1(x) + I_0(x)$
9. $\frac{d}{dx} [I_0(x)] = I_1(x)$
10. $x K_{n-1}(x) - x K_{n+1}(x) = -2n K_n(x)$
11. $K_{n-1}(x) + K_{n+1}(x) = -2 \frac{d}{dx} [K_n(x)]$
12. $x \frac{d}{dx} [K_n(x)] + n K_n(x) = -x K_{n-1}(x)$
13. $x \frac{d}{dx} [K_n(x)] - n K_n(x) = -x K_{n+1}(x)$
14. $\left(\frac{1}{x} \frac{d}{dx}\right)^m [x^n K_n(x)] = (-1)^m x^{n-m} K_{n-m}(x)$
15. $\left(\frac{1}{x} \frac{d}{dx}\right)^m [x^{-n} K_n(x)] = (-1)^m x^{-n-m} K_{n+m}(x)$
16. $K_{-\nu}(x) = K_\nu(x)$
17. $K_2(x) = \frac{2}{x} K_1(x) + K_0(x)$

18. $\frac{d}{dx} [K_0(x)] = -K_1(x)$
19. $K_{-n}(x) = K_n(x)$ [n an integer]

17.11 INTEGRAL REPRESENTATIONS OF $J_n(x)$, $I_n(x)$, AND $K_n(x)$

17.11.1 Integral Representations of $J_n(x)$

17.11.1.1

1. $J_0(x) = \frac{2}{\pi} \int_0^{\pi/2} \cos(x \cos \theta) d\theta$
2. $J_1(x) = \frac{2}{\pi} \int_0^{\pi/2} \sin(x \cos \theta) \cos \theta d\theta$
3. $J_n(x) = \frac{1}{\pi} \int_0^\pi \cos(x \sin \theta - n\theta) d\theta$
4. $J_n(x) = \frac{1}{\pi} \int_0^\pi \cos(x \sin \theta) \cos n\theta d\theta$ [$n = 0, 2, 4, \dots$]
5. $J_n(x) = \frac{1}{\pi} \int_0^\pi \sin(x \sin \theta) \sin n\theta d\theta$ [$n = 1, 3, 5, \dots$]
6. $J_n(x) = \frac{2}{\sqrt{\pi} \Gamma(n + \frac{1}{2})} \left(\frac{x}{2}\right)^n \int_0^{\pi/2} \cos(x \sin \theta) (\cos \theta)^{2n} d\theta$
7. $J_n(x) = \frac{2}{\sqrt{\pi} \Gamma(n + \frac{1}{2})} \left(\frac{x}{2}\right)^n \int_0^{\pi/2} \cos(x \sin \theta) (\sin \theta)^{2n} d\theta$
8. $I_n(x) = \frac{2}{\sqrt{\pi} \Gamma(n + \frac{1}{2})} \left(\frac{x}{2}\right)^n \int_0^{\pi/2} \cosh(x \sin \theta) (\cos \theta)^{2n} d\theta$
9. $I_n(x) = \frac{2}{\sqrt{\pi} \Gamma(n + \frac{1}{2})} \left(\frac{x}{2}\right)^n \int_0^{\pi/2} \cosh(x \sin \theta) (\sin \theta)^{2n} d\theta$
10. $K_n(x) = e^{-x} \sqrt{\frac{\pi}{2x}} \frac{1}{\Gamma(n + \frac{1}{2})} \int_0^\infty e^{-u} u^{n-1/2} \left(1 + \frac{u}{2x}\right)^{n-1/2} du$

17.12 INDEFINITE INTEGRALS OF BESSEL FUNCTIONS

17.12.1 Integrals of $J_n(x)$, $I_n(x)$, and $K_n(x)$

17.12.1.1

1. $\int x J_0(ax) dx = \frac{x}{a} J_1(ax)$

2. $\int x^2 J_0(ax) dx = \frac{x^2}{a} J_1(ax) + \frac{x}{a^2} J_0(ax) - \frac{1}{a^2} \int J_0(ax) dx$
3. $\int \frac{J_0(ax)}{x^2} dx = a J_1(ax) - \frac{J_0(ax)}{x} - a^2 \int J_0(ax) dx$
4. $\int J_1(ax) dx = -\frac{1}{a} J_0(ax)$
5. $\int x J_1(ax) dx = -\frac{x}{a} J_0(ax) + \frac{1}{a} \int J_0(ax) dx$
6. $\int \frac{J_1(ax)}{x} dx = -J_1(ax) + a \int J_0(ax) dx$
7. $\int x J_n(ax) J_n(bx) dx = \frac{x [a J_{n-1}(ax) J_n(bx) - b J_n(ax) J_{n-1}(bx)]}{b^2 - a^2} \quad [a \neq b]$
8. $\int x J_n^2(ax) dx = \frac{1}{2} x^2 [J_n^2(ax) - J_{n-1}(ax) J_{n+1}(ax)]$
9. $\int x^n J_{n-1}(ax) dx = \frac{x^n}{a} J_n(ax)$
10. $\int x^{-n} J_{n+1}(ax) dx = -\frac{x^{-n}}{a} J_n(ax)$
11. $\int x^n I_{n-1}(ax) dx = \frac{x^n}{a} I_n(ax)$
12. $\int x^{-n} I_{n+1}(ax) dx = \frac{x^{-n}}{a} I_n(ax)$
13. $\int x^n K_{n-1}(ax) dx = -\frac{x^n}{a} K_n(ax)$
14. $\int x^{-n} K_{n+1}(ax) dx = -\frac{x^{-n}}{a} K_n(ax)$

The integrals involving $J_n(x)$ are also true when $J_n(x)$ is replaced by any other Bessel function.

17.13 DEFINITE INTEGRALS INVOLVING BESSEL FUNCTIONS

17.13.1 Definite Integrals Involving $J_n(x)$ and Elementary Functions

17.13.1.1

1. $\int_0^a J_1(x) dx = 1 - J_0(a) \quad [a > 0]$
2. $\int_a^\infty J_1(x) dx = J_0(a) \quad [a > 0]$
3. $\int_0^\infty J_n(ax) dx = \frac{1}{a} \quad [n > -1, a > 0]$

$$4. \int_0^{\infty} \frac{J_n(ax)}{x} dx = \frac{1}{n} \quad [n = 1, 2, \dots]$$

$$5. \int_0^1 x J_n(ax) J_n(bx) dx = \begin{cases} 0, & a \neq b, J_n(a) = J_n(b) = 0 \\ \frac{1}{2} [J_{n+1}(a)]^2, & a = b, J_n(a) = J_n(b) = 0 \end{cases} \quad [n > -1]$$

$$6. \int_0^{\infty} e^{-ax} J_0(bx) dx = \frac{1}{\sqrt{a^2 + b^2}}$$

$$7. \int_0^{\infty} e^{-ax} J_n(bx) dx = \frac{1}{\sqrt{a^2 + b^2}} \left[\frac{\sqrt{a^2 + b^2} - a}{b} \right]^n \quad [a > 0, n = 0, 1, 2, \dots]$$

$$8. \int_0^{\infty} J_n(ax) \sin bx dx = \begin{cases} \frac{\sin [n \arcsin(b/a)]}{\sqrt{a^2 - b^2}}, & 0 < b < a \\ \frac{a^n \cos(n\pi/2)}{\sqrt{b^2 - a^2} (b + \sqrt{b^2 - a^2})^n}, & 0 < a < b \end{cases} \quad [n > -2]$$

$$9. \int_0^{\infty} J_n(ax) \cos bx dx = \begin{cases} \frac{\cos [n \arccos(b/a)]}{\sqrt{a^2 - b^2}}, & 0 < b < a \\ \frac{-a^n \sin(n\pi/2)}{\sqrt{b^2 - a^2} (b + \sqrt{b^2 - a^2})^n}, & 0 < a < b \end{cases} \quad [n > -2]$$

$$10. \int_0^{\infty} \frac{J_m(x) J_n(x)}{x} dx = \begin{cases} \frac{2}{\pi(m^2 - n^2)} \sin \frac{(m-n)\pi}{2}, & m \neq n \\ 1/2m, & m = n \end{cases} \quad [m + n > 0]$$

$$11. \int_0^{\infty} J_0(ax) J_1(bx) dx = \begin{cases} 1/b, & b^2 > a^2 \\ 0, & b^2 < a^2 \end{cases}$$

$$12. \int_0^{\infty} J_0(ax) J_1(ax) dx = \frac{1}{2a} \quad [a > 0]$$

17.14 SPHERICAL BESSEL FUNCTIONS

17.14.1 The Differential Equation

17.14.1.1

When the Helmholtz equation for a function V is expressed in terms of the spherical coordinates (r, θ, ϕ) (see **24.3.1.3(h)**), and the variables are separated by setting $V = R(r) \Theta(\theta) \Phi(\phi)$, the equation for $R(r)$ becomes

$$1. \quad r^2 \frac{d^2 R}{dr^2} + 2r \frac{dR}{dr} + [\lambda^2 r^2 - n(n+1)] R = 0,$$

which is the differential equation satisfied by **spherical Bessel functions**, though it is *not* Bessel's equation. Its solutions are found in terms of Bessel functions of fractional order by replacing r by x and $R(\lambda r)$ by $y(\lambda x)/\sqrt{\lambda x}$, when the equation is transformed into

$$2. \quad x^2 \frac{d^2 y}{dx^2} + 2x \frac{dy}{dx} + \left[\lambda^2 x^2 - \left(n + \frac{1}{2} \right)^2 \right] y = 0,$$

which is Bessel's equation of order $n + \frac{1}{2}$, where $n = 0, 1, 2, \dots$. The solutions of this equation can be found by using the results of Section 17.3 that define Bessel functions of fractional order in terms of trigonometric functions.

The spherical Bessel equation has two linearly independent solutions denoted by $j_n(\lambda x)$ and $y_n(\lambda x)$, so its general solution is

$$3. \quad y = A j_n(\lambda x) + B y_n(\lambda x),$$

where $j_n(x)$ and $y_n(x)$ are defined as

$$4. \quad j_n(x) = \sqrt{\frac{\pi}{2x}} J_{n+1/2}(x), \quad y_n(x) = \sqrt{\frac{\pi}{2x}} Y_{n+1/2}(x) = (-1)^{n+1} J_{-(n+1/2)}(x).$$

Take note that books using $N_n(\lambda x)$ for the Bessel function of the second kind of order n in place of the $Y_n(\lambda x)$ used here usually use $n_n(\lambda x)$ in place of the $y_n(\lambda x)$ used here.

17.14.2 The Spherical Bessel Function $j_n(x)$ and $y_n(x)$

17.14.2.1

From 17.4.1.4 we have

$$1. \quad j_0(x) = \frac{\sin x}{x}, \quad j_1(x) = -\frac{\cos x}{x} + \frac{\sin x}{x^2},$$

$$j_2(x) = \left(\frac{3}{x^3} - \frac{1}{x} \right) \sin x - \frac{3}{x^2} \cos x, \dots$$

$$2. \quad y_0(x) = -\frac{\cos x}{x}, \quad y_1(x) = -\frac{\sin x}{x} - \frac{\cos x}{x^2},$$

$$y_2(x) = \left(-\frac{3}{x^3} + \frac{1}{x} \right) \cos x - \frac{3}{x^2} \sin x, \dots$$

In general, we have the Rayleigh formulas

$$3. \quad j_n(x) = (-1)^n x^n \left(\frac{d}{dx} \right)^n \left(\frac{\sin x}{x} \right), \quad y_n(x) = (-1)^{n+1} x^n \left(\frac{d}{dx} \right)^n \left(\frac{\cos x}{x} \right).$$

The spherical Bessel functions $j_n(x)$ are finite at the origin and decay to zero as $x \rightarrow \infty$, whereas the spherical Bessel functions $y_n(x)$ are infinite at the origin but also decay to zero as $x \rightarrow \infty$.

17.14.3 Recurrence Relations

If $h_n(x)$ represents either $j_n(x)$ or $y_n(x)$, the function $h_n(x)$ satisfies the recurrence relations

1. $h_{n+1}(x) = (2n+1) \frac{h_n(x)}{x} - h_{n-1}(x)$
2.
$$\begin{aligned} h'_n(x) &= \frac{n}{2n+1} h_{n-1}(x) - \frac{n+1}{2n+1} h_{n+1}(x) \\ &= h_{n-1}(x) - \frac{n+1}{x} h_n(x) \\ &= \frac{n}{x} h_n(x) - h_{n+1}(x) \end{aligned}$$
3. $\left(\frac{d}{dx} \right)^m [x^{n+1} h_n(x)] = x^{n-m+1} h_{n-m}(x), \quad (n = 0, \pm 1, \pm 2, \dots, \quad m = 1, 2, 3, \dots)$
4. $\left(\frac{d}{dx} \right)^m [x^{-n} h_n(x)] = (-1)^m x^{-(n+m)} h_{n+m}(x), \quad (n = 0, \pm 1, \pm 2, \dots, \quad m = 1, 2, 3, \dots)$

17.14.4 Series Representations

17.14.4.1

1.
$$j_n(x) = \frac{x^n}{1 \cdot 3 \cdot 5 \cdots (2n+1)} \left\{ 1 - \frac{\frac{1}{2}x^2}{1!(2n+3)} + \frac{\left(\frac{1}{2}x^2\right)^2}{2!(2n+3)(2n+5)} - \cdots \right\}$$
2.
$$y_n(x) = -\frac{1 \cdot 3 \cdot 5 \cdots (2n-1)}{x^{n+1}} \left\{ 1 - \frac{\frac{1}{2}x^2}{1!(1-2n)} + \frac{\left(\frac{1}{2}x^2\right)^2}{2!(1-2n)(3-2n)} - \cdots \right\}$$

17.14.5 Limiting Values as $x \rightarrow 0$

When the second term in the expansions **17.14.4(1)** and **(2)** is much smaller than the first term:

1. $j_n(x) \rightarrow \frac{x^n}{(2n+1)!!}, \quad y_n(x) \rightarrow -x^{-(n+1)} (2n-1)!!$

17.14.6 Asymptotic Expansions of $j_n(x)$ and $y_n(x)$ When the Order n Is Large

1. $j_n(x) \sim \frac{1}{x} \cos \left[x - \frac{1}{2}(n+1)\pi \right]$
2. $y_n(x) \sim \frac{1}{x} \sin \left[x - \frac{1}{2}(n+1)\pi \right]$

17.15 FOURIER-BESSEL EXPANSIONS

A function $f(r)$ can be expanded over the interval $0 \leq r \leq R$ in terms of the Bessel function J_n , with fixed n , to obtain a **Fourier-Bessel expansion** of the form

1. $f(r) = \sum_{k=1}^{\infty} a_k J_n(j_{n,k}r/R) = a_1 J_n(j_{n,1}r/R) + a_2 J_n(j_{n,2}r/R) + \cdots,$

where $j_{n,k}$ is the k th zero of $J_n(x)$, the first few of which are listed in **17.5.1**, and the coefficients a_k are given by

2. $a_k = \left(\frac{2}{R^2} \right) \frac{\int_0^R J_n(j_{n,k}r/R) f(r) dr}{\left[\int_0^R J_{n+1}(j_{n,k}) \right]^2}, \quad [k = 1, 2, \dots]$

Example When a stretched uniformly thin circular elastic drumhead of radius R is disturbed from its equilibrium position, its oscillatory displacement $u(r, \theta, t)$ perpendicular to its equilibrium position at (r, θ) is determined by the wave equation in plane polar coordinates

$$u_{tt} = c^2(u_{rr} + (1/r)u_r + (1/r^2)u_{\theta\theta}), \quad (1)$$

where r is the radial distance from the center, θ is an angle in the drumhead measured from a fixed line in the equilibrium position, and t is the time. When the variables are separated by setting $u = R(r)\Theta(\theta)T(t)$ the normal displacement $u(r, \theta, t)$ at time t can be written as $u(r, \theta, t) = U(r, \theta)T(t)$, where U describes the spatial displacement and satisfies the Helmholtz equation $\nabla^2 U + \lambda^2 U = 0$, with λ a separation constant (see **25.2.1**) and ∇^2 is the Laplacian in (1). As $U(r, \Theta) = R(r)\Theta(\theta)$, each term $J_n(j_{n,k}r/R)$ in the Fourier-Bessel expansion in equation 1 is a term in $R(r)$, and the displacement at the point (r, θ) is of the form, $U_{nm}(r, \theta) = J_n(j_{n,m}r/R)[A \sin n\theta + b \cos n\theta]$, with $n = 0, 1, 2, \dots$ and $m = 1, 2, \dots$. This spatial mode is modulated by a sinusoidal time variation with frequency $j_{n,m}c/(2\pi)$ cycles in a unit time. When the initial configuration of the drumhead is given by specifying $f(r)$, the displacement of the drumhead $U(r, \theta)$ follows once results of equation 2 are used with the Fourier-Bessel expansion in equation 1. If the expansion is performed in terms of J_1 , a representative mode $U_{12}(r, \theta) = J_1(j_{1,2}r/R) \cos \theta$, for which $j_{1,2} = 7.01559$, and typically $A = 1, B = 0$, is shown in Figure 17.4(a), while Figure 17.4(b) shows a contour plot of this mode.

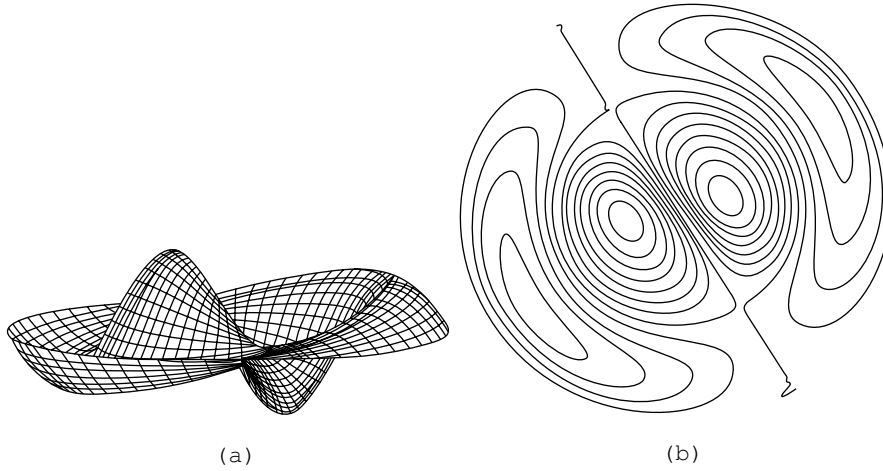
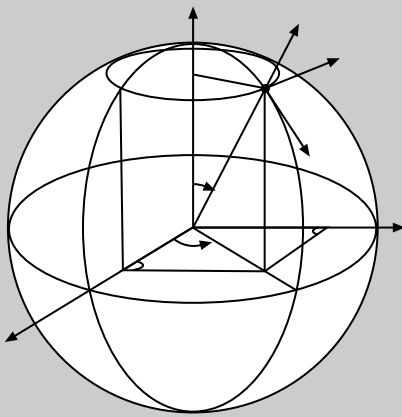

Figure 17.4.

The time variation of this mode is obtained by modulating it with a sinusoid of frequency $j_{1,2}c/(2\pi)$, and when $f(r)$ is specified, the corresponding term in the expansion in equation 1 is multiplied by the coefficient a_2 found from 2. Unless $f(r)$ is particularly simple, it becomes necessary to determine the coefficients a_k by means of numerical integration.



Chapter 18

Orthogonal Polynomials

18.1 INTRODUCTION

18.1.1 Definition of a System of Orthogonal Polynomials

18.1.1.1

Let $\{\Phi_n(x)\}$ be a system of polynomials defined for $a \leq x \leq b$ such that $\Phi_n(x)$ is of degree n , and let $w(x) > 0$ be a function defined for $a \leq x \leq b$. Define the positive numbers $\|\Phi_n\|^2$ as

$$1. \quad \|\Phi_n\|^2 = \int_a^b [\Phi_n(x)]^2 w(x) dx.$$

Then the system of polynomials $\{\Phi_n(x)\}$ is said to be **orthogonal over $a \leq x \leq b$ with respect to the weight function $w(x)$** if

$$2. \quad \int_a^b \Phi_m(x)\Phi_n(x)w(x) dx = \begin{cases} 0, & m \neq n \\ \|\Phi_n\|^2, & m = n \end{cases} \quad [m, n = 0, 1, 2, \dots].$$

The **normalized** system of polynomials $[\phi_n(x)]$, where $\phi_n(x) = \Phi_n(x)/\|\Phi_n\|$, is said to be **orthonormal** over $a \leq x \leq b$ with respect to the **weight function $w(x)$** , where $\|\Phi_n\|$ is called the **norm** of $\Phi_n(x)$ and it follows from 18.1.1.1.1–2 that

$$3. \quad \int_a^b \phi_m(x)\phi_n(x)w(x) dx = \begin{cases} 0, & m \neq n \\ 1, & m = n \end{cases} \quad [m, n = 0, 1, 2, \dots].$$

Orthogonal polynomials are special solutions of linear variable coefficient second-order differential equations defined on the interval $a \leq x \leq b$, in which n appears as a parameter.

These polynomials can be generated by differentiation of a suitable sequence of functions (**Rodrigues' formula**), and they satisfy recurrence relations.

18.2 LEGENDRE POLYNOMIALS $P_n(x)$

18.2.1 Differential Equation Satisfied by $P_n(x)$

18.2.1.1

The **Legendre polynomials** $P_n(x)$ satisfy the differential equation

$$1. \quad (1-x^2) \frac{d^2y}{dx^2} - 2x \frac{dy}{dx} + n(n+1)y = 0$$

defined on the interval $-1 \leq x \leq 1$, with $n = 0, 1, 2, \dots$

18.2.2 Rodrigues' Formula for $P_n(x)$

18.2.2.1

The Legendre polynomial $P_n(x)$ of degree n is given by **Rodrigues' formula**:

$$1. \quad P_n(x) = \frac{1}{2^n n!} \frac{d^n}{dx^n} [(x^2 - 1)^n].$$

18.2.3 Orthogonality Relation for $P_n(x)$

18.2.3.1

The **weight function** for Legendre polynomials is $w(x) = 1$, and the **orthogonality relation** is

$$\int_{-1}^1 P_m(x) P_n(x) dx = \begin{cases} 0, & \text{for } m \neq n \\ \frac{2}{2n+1}, & \text{for } m = n \end{cases} \quad [n = 0, 1, 2, \dots].$$

A function $f(x)$ can be expanded over the interval $-1 \leq x \leq 1$ in terms of the Legendre polynomials to obtain a **Fourier-Legendre expansion** of the form

$$f(x) = \sum_{n=0}^{\infty} a_n P_n(x) = a_0 + a_1 P_1(x) + a_2 P_2(x) + \dots,$$

where the coefficients a_n are given by

$$a_n = \left(\frac{2n+1}{2} \right) \int_{-1}^1 f(x) P_n(x) dx, \quad [n = 0, 1, 2, \dots]$$

18.2.4 Explicit Expressions for $P_n(x)$

18.2.4.1

$$1. \quad P_n(x) = \frac{1}{2^n} \sum_{k=0}^{[n/2]} \frac{(-1)^k (2n-2k)!}{k!(n-k)!(n-2k)!} x^{n-2k}$$

$$= \frac{(2n)!}{2^n(n!)^2} \left[x^n - \frac{n(n-1)}{2(2n-1)}x^{n-2} + \frac{n(n-1)(n-2)(n-3)}{2 \cdot 4(2n-1)(2n-3)}x^{n-4} - \dots \right]$$

$\left[\left[\frac{n}{2} \right] \right]$ signifies the integral part of $\frac{n}{2}$

$$2. \quad P_{2n}(x) = (-1)^n \frac{(2n-1)!!}{2^n n!} \left[1 - \frac{2n(2n+1)}{2!}x^2 + \frac{2n(2n-2)(2n+1)(2n+3)}{4!}x^4 - \dots \right]$$

$[(2n-1)!! = 1 \cdot 3 \cdot 5 \cdots (2n-1)]$

$$3. \quad P_{2n+1}(x) = (-1)^n \frac{(2n+1)!!}{2^n n!} \left[x - \frac{2n(2n+3)}{3!}x^3 + \frac{2n(2n-2)(2n+3)(2n+5)}{5!}x^5 - \dots \right]$$

$[(2n+1)!! = 1 \cdot 3 \cdot 5 \cdots (2n+1)]$

18.2.4.2 Special Cases and Graphs of $P_n(x)$

Notation: $x = \cos \theta$

$$1. \quad P_0(x) = 1$$

$$2. \quad P_1(x) = x = \cos \theta$$

$$3. \quad P_2(x) = \frac{1}{2}(3x^2 - 1) = \frac{1}{4}(3 \cos 2\theta + 1)$$

$$4. \quad P_3(x) = \frac{1}{2}(5x^3 - 3x) = \frac{1}{8}(5 \cos 3\theta + 3 \cos \theta)$$

$$5. \quad P_4(x) = \frac{1}{8}(35x^4 - 30x^2 + 3) = \frac{1}{64}(35 \cos 4\theta + 20 \cos 2\theta + 9)$$

$$6. \quad P_5(x) = \frac{1}{8}(63x^5 - 70x^3 + 15x) = \frac{1}{128}(63 \cos 5\theta + 35 \cos 3\theta + 30 \cos \theta)$$

$$7. \quad P_6(x) = \frac{1}{16}(231x^6 - 315x^4 + 105x^2 - 5) \\ = \frac{1}{512}(231 \cos 6\theta + 126 \cos 4\theta + 105 \cos 2\theta + 50)$$

Graphs of these polynomials are shown in Figure 18.1.

Powers of x in terms of $P_n(x)$

$$1. \quad 1 = P_0(x)$$

$$2. \quad x = P_1(x)$$

$$3. \quad x^2 = \frac{1}{3}(2P_2(x) + P_0(x))$$

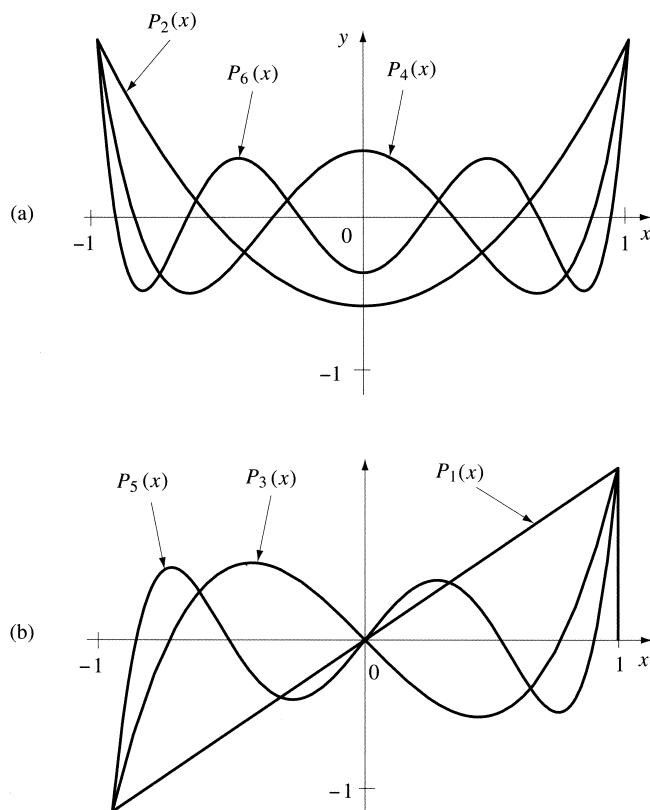

Figure 18.1. Legendre polynomials $P_n(x)$: (a) even polynomials and (b) odd polynomials.

4. $x^3 = \frac{1}{5}(2P_3(x) + 3P_1(x))$
5. $x^4 = \frac{1}{35}(8P_4(x) + 20P_2(x) + 7P_0(x))$
6. $x^5 = \frac{1}{63}(8P_5(x) + 28P_3(x) + 27P_1(x))$
7. $x^6 = \frac{1}{231}(16P_6(x) + 72P_4(x) + 110P_2(x) + 33P_0(x))$

18.2.5 Recurrence Relations Satisfied by $P_n(x)$

18.2.5.1

1. $(n+1)P_{n+1}(x) = (2n+1)xP_n(x) - nP_{n-1}(x)$
2. $(x^2 - 1)\frac{d}{dx}[P_n(x)] = nxP_n(x) - nP_{n-1}(x)$

$$= \frac{n(n+1)}{2n+1}[P_{n+1}(x) - P_{n-1}(x)]$$

3. $\frac{d}{dx}[P_{n+1}(x)] - x\frac{d}{dx}[P_n(x)] = (n+1)P_n(x)$
4. $x\frac{d}{dx}[P_n(x)] - \frac{d}{dx}[P_{n-1}(x)] = nP_n(x)$
5. $\frac{d}{dx}[P_{n+1}(x) - P_{n-1}(x)] = (2n+1)P_n(x)$
6. $\frac{d}{dx}[P_{n+1}(x)] + \frac{d}{dx}[P_{n-1}(x)] = 2x\frac{d}{dx}[P_n(x)] + P_n(x)$
7. $(1-x^2)\frac{d}{dx}[P_n(x)] = (n+1)(xP_n(x) - P_{n+1}(x))$

18.2.6 Generating Function for $P_n(x)$

18.2.6.1

The Legendre polynomial $P_n(x)$ occurs as the multiplier of t^n in the expansion of the **generating function**:

$$1. \quad \frac{1}{\sqrt{1-2tx+t^2}} = \sum_{k=0}^{\infty} P_k(x)t^k \quad \left[|t| < \min|x \pm \sqrt{x^2-1}|\right]$$

18.2.7 Legendre Functions of the Second Kind $Q_n(x)$

18.2.7.1

There is a nonpolynomial solution to the Legendre differential equation 18.2.1.1.1 that is linearly independent of the Legendre polynomial $P_n(x)$ and that has singularities at $x = \pm 1$. This solution, denoted by $Q_n(x)$, is called the **Legendre function of the second kind** of order n , to distinguish it from $P_n(x)$, which is the corresponding function of the first kind.

The general solution of the Legendre differential equation 18.2.1.1.1 on the interval $-1 < x < 1$ with $n = 0, 1, 2, \dots$, is

$$1. \quad y(x) = AP_n(x) + BQ_n(x),$$

where A and B are arbitrary constants.

The functions $Q_n(x)$, the first six of which are listed below, satisfy the same recurrence relations as those for $P_n(x)$ given in 18.2.5.1.

2. $Q_0(x) = \frac{1}{2} \ln\left(\frac{1+x}{1-x}\right)$
3. $Q_1(x) = \frac{x}{2} \ln\left(\frac{1+x}{1-x}\right) - 1$
4. $Q_2(x) = \frac{1}{4}(3x^2 - 1) \ln\left(\frac{1+x}{1-x}\right) - \frac{3}{2}x$
5. $Q_3(x) = \frac{1}{4}(5x^3 - 3x) \ln\left(\frac{1+x}{1-x}\right) - \frac{5}{2}x^2 + \frac{2}{3}$

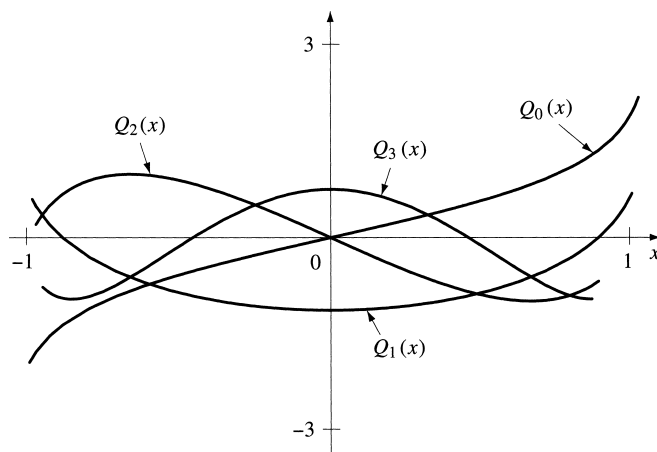

Figure 18.2. Legendre functions $Q_n(x)$.

$$6. \quad Q_4(x) = \frac{1}{16}(35x^4 - 30x^2 + 3) \ln\left(\frac{1+x}{1-x}\right) - \frac{35}{8}x^3 + \frac{55}{24}x$$

$$7. \quad Q_5(x) = \frac{1}{16}(63x^5 - 70x^3 + 15x) \ln\left(\frac{1+x}{1-x}\right) - \frac{63}{8}x^4 + \frac{49}{8}x^2 - \frac{8}{15}$$

Graphs of $Q_n(x)$ for $-0.95 \leq x \leq 0.95$ and $n = 0, 1, 2, 3$ are shown in Figure 18.2.

18.2.7.2 Recurrence Relations for $Q_n(x)$

1. $(2n+1)xQ_n(x) = (n+1)Q_{n+1}(x) + nQ_{n-1}(x) \quad [|x| < 1 \text{ and } |x| > 1]$
2. $(2n+1)Q_n(x) = \frac{d}{dx}[Q_{n+1}(x)] - \frac{d}{dx}[Q_{n-1}(x)] \quad [|x| < 1 \text{ and } |x| > 1]$

18.2.7.3 A Connection Between $P_n(x)$ and $Q_n(x)$ and $P_n(-x)$ and $P_n(x)$

1. $n[P_n(x)Q_{n-1}(x) - P_{n-1}(x)Q_n(x)] = P_1(x)Q_0(x) - P_0(x)Q_1(x) \quad [|x| < 1]$
2. $P_n(-x) = (-1)^n P_n(x)$

18.2.7.4 Summation Formulas

1. $(x-y) \sum_{m=0}^n (2m+1)P_m(x)P_m(y) = (n+1)[P_{n+1}(x)P_n(y) - P_n(x)P_{n+1}(y)]$
2. $(x-y) \sum_{m=0}^n (2m+1)Q_m(x)P_m(y) = 1 - (n+1)[P_{n+1}(y)Q_n(x) - P_n(y)Q_{n+1}(x)]$

18.2.8 Definite Integrals Involving $P_n(x)$

1. $\int_0^1 x^2 P_{n-1}(x) P_{n+1}(x) dx = \frac{n(n+1)}{(2n-1)(2n+1)(2n+3)}$
2. $\int_{-1}^1 x^r P_n(x) dx = 0, \quad r = 0, 1, 2, \dots, n-1$
3. $\int_{-1}^1 x^n P_n(x) dx = \frac{2^{n+1}(n!)^2}{(2n+1)!}$
4. $\int_{-1}^1 [P_n(x)]^2 dx = \frac{2}{2n+1}$
5. $\int_{-1}^1 x^{2r} P_{2n}(x) dx = \frac{2^{2n+1}(2r)!(r+n)!}{(2r+2n+1)!(r-n)!}, \quad r \geq n$
6. $\int_{-1}^1 P_n(x) \arcsin x dx = \begin{cases} 0 & n \text{ even} \\ \pi \left[\frac{1 \cdot 3 \cdot 5 \cdots (n-2)}{2 \cdot 4 \cdot 6 \cdots (n+1)} \right]^2 & n \text{ odd} \end{cases}$
7. $\int_{-1}^1 \frac{P_n(x)}{\sqrt{1-x^2}} dx = \frac{2^{3/2}}{2n+1}$
8. $\int_{-1}^1 (1-x^2) [P'_n(x)]^2 dx = \frac{2n(n+1)}{2n+1}$
9. $\int_0^{2\pi} P_{2n}(\cos \theta) d\theta = \frac{2\pi}{2^{4n}} \binom{2n}{n}$
10. $\int_0^{2\pi} P_{2n+1}(\cos \theta) \cos \theta d\theta = \frac{\pi}{2^{4n+2}} \binom{2n}{n} \binom{2n+2}{n+1}$

18.2.9 Special Values

1. $P_n(\pm 1) = (\pm 1)^n$
2. $P_{2n}(0) = (-1)^n \frac{(2n)!}{2^{2n}(n!)^2}$
3. $P_{2n+1}(0) = 0$
4. $P'_{2n}(0) = 0$
5. $P'_{2n}(0) = 0$
6. $P'_{2n+1}(0) = (-1)^n \frac{(2n+1) \left(\frac{1}{2}\right)_n}{n!}$

[for the Pochhammer symbol $(a)_n$ see Section 0.3]

18.2.10 Associated Legendre Functions

18.2.10.1 The Differential Equation and the Functions $P_n^m(x)$ and $P_n^m(\theta)$

When the Laplace equation for a function V is expressed in terms of the spherical coordinates (r, θ, ϕ) (see **24.3.1.3(h)**), and the variables are separated by setting $V = R(r)\Theta(\theta)\Phi(\phi)$, the equation for $\Theta(\theta)$ with $x = \cos \theta$ is found to be

$$1. \quad (1-x^2)\frac{d^2\Theta(x)}{dx^2} - 2x\frac{d\Theta(x)}{dx} + \left[n(n+1) - \frac{m^2}{1-x^2} \right] \Theta(x) = 0,$$

where m is the separation constant introduced because of the dependence of V on ϕ , and n is a separation constant introduced because of the dependence of V on θ (see Section **25.2.1**). This is called the **associated Legendre equation**, and when $m = 0$, it reduces to the Legendre equation. Like the Legendre equation, the associated Legendre equation also has two linearly independent solutions, one of which is a function that remains finite for $-1 \leq x \leq 1$, while the other is a function that becomes infinite at $x = \pm 1$. As $\Theta(x)$ depends on the two parameters m and n , the two solutions are called **associated Legendre functions**. The solution that remains finite is a polynomial denoted by the symbol $P_n^m(x)$, and the differential equation satisfied by $P_n^m(x)$ is

$$2. \quad (1-x^2)\frac{d^2P_n^m(x)}{dx^2} - 2x\frac{dP_n^m(x)}{dx} + \left[n(n+1) - \frac{m^2}{1-x^2} \right] P_n^m(x) = 0.$$

When this equation is expressed in terms of θ , it becomes

$$3. \quad \frac{1}{\sin \theta} \frac{d}{d\theta} \left(\sin \theta \frac{dP_n^m(\theta)}{d\theta} \right) + \left[n(n+1) - \frac{m^2}{\sin^2 \theta} \right] P_n^m(\theta) = 0.$$

The second solution is a function denoted by $Q_n^m(x)$, and it satisfies equation 2 with $P_n^m(x)$ replaced by $Q_n^m(x)$, while in terms of θ , the function $Q_n^m(\theta)$ satisfies equation 3 with $P_n^m(\theta)$ replaced by $Q_n^m(\theta)$.

The connection between $P_n^m(x)$ and the Legendre polynomial $P_n(x)$, and between the associated Legendre function $Q_n^m(x)$ and the Legendre function $Q_n(x)$ is provided by the general results

$$4. \quad P_n^m(x) = (1-x^2)^{m/2} \frac{d^m}{dx^m} P_n(x), \quad Q_n^m(x) = (1-x^2)^{m/2} \frac{d^m}{dx^m} Q_n(x),$$

where $P_n^m(x) \equiv 0$ if $m > n$.

$$5. \quad P_n^m(-x) = (-1)^{m+n} P_n^m(x) \quad \text{with} \quad P_n^m(\pm 1) = 0 \quad \text{when} \quad m \neq 0.$$

The first few associated Legendre polynomials $P_n^m(x)$, equivalently $P_n^m(\theta)$, are:

$$P_1^1(x) = (1-x^2)^{1/2}, \quad \text{equivalently} \quad P_1^1(\theta) = \sin \theta$$

$$P_2^1(x) = 3x(1-x^2)^{1/2}, \text{ equivalently } P_2^1(\theta) = 3\cos\theta\sin\theta$$

$$P_2^2(x) = 3(1-x^2)^{1/2}, \text{ equivalently } P_2^2(\theta) = 3\sin^2\theta$$

$$P_3^1(x) = \frac{3}{2}(1-x^2)^{1/2}(5x^2-1), \text{ equivalently } P_3^1(\theta) = \frac{3}{2}\sin\theta(5\cos^2\theta-1)$$

$$P_3^2(x) = 15x(1-x^2), \text{ equivalently } P_3^2(\theta) = 15\cos\theta\sin^2\theta$$

$$P_3^3(x) = 15(1-x^2)^{3/2}, \text{ equivalently } P_3^3(\theta) = 15\sin^3(\theta)$$

Results for larger values of m and n can be found from the recurrence relations in Section 18.2.10.2 or from the general definition of $P_n^m(x)$ in 4.

18.2.10.2 The Recurrence Relations

Many recurrence relations exist, and some of the most useful are:

1. $(2n+1)xP_n^m(x) = (m+n)P_{n-1}^m(x) + (n-m+1)P_{n+1}^m(x)$
2. $P_n^{m+1}(x) = \frac{2mx}{(1-x^2)^{1/2}}P_n^m(x) + [m(m-1) - n(n+1)]P_n^{m-1}(x)$
3. $P_{n+1}^{m+1}(x) - P_{n-1}^{m+1}(x) = (2n+1)(1-x^2)^{1/2}P_n^m(x) - (m+n)(m+n-1)P_{n-1}^{m-1}(x) \\ + (n-m+1)(n-m+2)P_{n+1}^{m-1}(x)$
4. $P_{n-1}^{m+1}(x) = (m-n)(1-x^2)^{1/2}P_n^m(x) + xP_n^{m+1}(x)$
5. $(m-n-1)P_{n+1}^m(x) = (m+n)P_{n-1}^m(x) - (2n+1)xP_n^m(x)$
6. $(1-x^2)\frac{dP_n^m(x)}{dx} = (m+n)P_{n-1}^m(x) - nxP_n^m(x)$
7. $(1-x^2)^{1/2}\frac{dP_n^m(x)}{dx} = \frac{1}{2}[P_n^{m+1}(x) - (m+n)(n-m+1)P_n^{m-1}(x)]$

The functions $Q_n^m(x)$ satisfy the same recurrence relations as the polynomials $P_n^m(x)$.

18.2.10.3 The Orthogonality Relations Satisfied by $P_n^m(x)$ and $P_n^m(\cos\theta)$

1. $\int_{-1}^1 P_n^m(x)P_k^m(x) dx = 0 \quad \text{if } n \neq k, \quad \int_{-1}^1 [P_n^m(x)]^2 dx = \frac{2}{2n+1} \frac{(n+m)!}{(n-m)!}$
2. $\int_0^\pi P_n^m(\cos\theta)P_k^m(\cos\theta) dx = 0 \quad \text{if } n \neq k, \quad \int_0^\pi [P_n^m(\cos\theta)]^2 dx = \frac{2}{2n+1} \frac{(n+m)!}{(n-m)!}$

18.2.11 Spherical Harmonics

When solutions u for the Laplace and Helmholtz equations are required in spherical regions, it becomes necessary to express the equations in terms of the spherical coordinates (r, θ, ϕ) (see Fig. 24.3). In this coordinate system, r is the radius, θ is the polar angle with $0 \leq \theta \leq \pi$, and ϕ is the azimuthal angle with $0 \leq \phi \leq 2\pi$. After separating the variables by setting $u(r, \theta, \phi) = R(r)\Theta(\theta)\Phi(\phi)$, the dependence of the solution u on the polar angle θ and the azimuthal angle ϕ is found to satisfy the equation

$$1. \quad \frac{1}{\Theta(\theta)} \frac{d}{\sin \theta} \frac{d}{d\theta} \left(\sin \theta \frac{d\Theta}{d\theta} \right) + \frac{1}{\Phi(\phi)} \frac{d^2 \Phi(\phi)}{\sin^2 \theta d\phi^2} + n(n+1) = 0,$$

where the integer n is a separation constant introduced when the variable r was separated. The first term in this equation is a function only of θ , and the expression $(1/\Phi(\phi))d^2\Phi/d\phi^2$ in the second term is a function only of ϕ , so as the functions $\Phi(\phi)$ and $\Theta(\theta)$ are independent for all ϕ and θ , for this result to be true, the terms in θ and in ϕ must each be equal to a constant. Setting the ϕ dependence equal to the separation constant $-m^2$, with m an integer, shows that the azimuthal dependence must obey the equation

$$2. \quad \frac{d^2 \Phi(\phi)}{d\phi^2} + m^2 \Phi(\phi) = 0.$$

So the two linearly independent azimuthal solutions are given by the two complex conjugate functions $\Phi_1(\phi) = e^{im\phi}$ and $\Phi_2(\phi) = e^{-im\phi}$. These two complex solutions could, of course, have been replaced by the two linearly independent real solutions $\sin m\phi$ and $\cos m\phi$, but for what is to follow, the complex representations will be retained.

When the ϕ dependence is removed from equation 1 and replaced with $-m^2$, the equation for the θ dependence that remains becomes the associated Legendre equation with solutions $P_n^m(\theta)$, namely

$$3. \quad \frac{1}{\sin \theta} \frac{d}{d\theta} \left(\sin \theta \frac{dP_n^m(\theta)}{d\theta} \right) + \left[n(n+1) - \frac{m^2}{\sin^2 \theta} \right] P_n^m(\theta) = 0.$$

Solutions of equation 1, called *spherical harmonics*, involve the product of $\Phi_1(\phi)$ or $\Phi_2(\phi)$ and $P_n^m(\theta)$, but unfortunately, there is no standard notation for spherical harmonics, nor is there agreement on whether $P_n^m(\theta)$ should be normalized when it is used in the definition of spherical harmonics. The products of these functions are called spherical harmonics because solutions of the Laplace equation are called harmonic functions, and these are harmonic functions on the surface of a sphere. As spherical harmonics are mainly used in physics, the notation and normalization in what is to follow are the ones used in that subject. However, whereas in mathematics a complex conjugate is denoted by an overbar, as is the case elsewhere in this book, in physics it is usually denoted by an asterisk *. The **spherical harmonic** $Y_n^m(\theta, \phi)$ defined as

$$4. \quad Y_n^m(\theta, \phi) = (-1)^m \sqrt{\left(\frac{2n+1}{2} \right) \left(\frac{(n-m)!}{(n+m)!} \right)} P_n^m(\cos \theta) e^{im\phi}, \quad \text{where } -n \leq m \leq n.$$

These functions are also called **surface harmonics** of the first kind, in which case they are known as **tesseral harmonics** when $m < n$ and as **sectoral harmonics** when $m = n$. The function Θ when Φ is constant is called a **zonal surface harmonic**. When m is negative, the spherical harmonic functions with positive and negative m are related by the equation

$$5. \quad Y_n^{-m}(\cos \theta) = (-1)^m (Y_n^m(\cos \theta))^*.$$

The following table lists the first few spherical harmonics for $m, n = 0, 1, 2, 3$, where the corresponding results for negative m follow from result 5.

Table of Spherical Harmonics

$$\begin{array}{l}
 n = 0 \\
 n = 1 \\
 n = 2 \\
 n = 3
 \end{array}
 \begin{array}{l}
 Y_0^0(\cos \theta) = \frac{1}{\sqrt{4\pi}} \\
 \left\{ \begin{array}{l} Y_1^1(\cos \theta) = -\sqrt{\frac{3}{8\pi}} \sin \theta e^{i\phi} \\ Y_1^0(\cos \theta) = \sqrt{\frac{3}{4\pi}} \cos \theta \end{array} \right. \\
 \left\{ \begin{array}{l} Y_2^2(\cos \theta) = \frac{1}{4} \sqrt{\frac{15}{2\pi}} \sin^2 \theta e^{2i\phi} \\ Y_2^1(\cos \theta) = -\sqrt{\frac{15}{8\pi}} \sin \theta \cos \theta e^{i\phi} \\ Y_2^0(\cos \theta) = \frac{1}{2} \sqrt{\frac{5}{4\pi}} (3 \cos^2 \theta - 1) \end{array} \right. \\
 \left\{ \begin{array}{l} Y_3^3(\cos \theta) = -\frac{1}{4} \sqrt{\frac{105}{4\pi}} \sin^3 \theta e^{3i\phi} \\ Y_3^2(\cos \theta) = \frac{1}{4} \sqrt{\frac{105}{2\pi}} \sin^2 \theta \cos \theta e^{2i\phi} \\ Y_3^1(\cos \theta) = -\frac{1}{4} \sqrt{\frac{21}{2\pi}} \sin \theta (5 \cos^2 \theta - 1) e^{i\phi} \\ Y_3^0(\cos \theta) = \frac{1}{2} \sqrt{\frac{7}{4\pi}} (5 \cos^3 \theta - 3 \cos \theta) \end{array} \right.
 \end{array}$$

The functions $P_n^m(\cos \theta)$ and Φ are each orthogonal over their respective intervals $0 \leq \theta \leq \pi$ and $0 \leq \phi \leq 2\pi$, and when this is taken into account together with the normalizations that have been used, the orthogonality of the spherical harmonics takes the form

$$6. \quad \int_{\phi=0}^{2\pi} \int_{\theta=0}^{\pi} (P_{n_1}^{m_1}(\theta, \phi))^* Y_{n_2}^{m_2}(\theta, \phi) \sin \theta d\theta d\phi = \delta_{n_1 n_2} \delta_{m_1 m_2},$$

where δ_{pq} is the Kronecker delta symbol defined in **1.4.2.1,8**.

This orthogonality property allows an arbitrary function $f(\theta, \phi)$ defined for $0 \leq \theta \leq \pi$, $0 \leq \phi \leq 2\pi$ to be expanded as a uniformly convergent series of the form

$$7. \quad f(\theta, \phi) = \sum c_{mn} Y_n^m(\theta, \phi),$$

where

$$8. \quad c_{mn} = \int_{\phi=0}^{2\pi} \int_{\theta=0}^{\pi} f(\theta, \phi) (Y_n^m(\theta, \phi))^* \sin \theta d\theta d\phi.$$

Let γ be the angle between two unit vectors \mathbf{u}_1 and \mathbf{u}_2 in space with the respective polar and azimuthal angles (θ_1, ϕ_1) and (θ_2, ϕ_2) . Then the **addition theorem** for spherical harmonics takes the form

$$P_r(\cos \gamma) = \frac{4\pi}{2r+1} \sum_{m=-r}^r Y_r^m(\theta_1, \phi_1) (Y_r^m(\theta_2, \phi_2))^*.$$

18.3 CHEBYSHEV POLYNOMIALS $T_n(x)$ AND $U_n(x)$

18.3.1 Differential Equation Satisfied by $T_n(x)$ and $U_n(x)$

18.3.1.1

The Chebyshev polynomials $T_n(x)$ and $U_n(x)$ satisfy the differential equation

$$1. \quad (1-x^2) \frac{d^2 y}{dx^2} - x \frac{dy}{dx} + n^2 y = 0,$$

defined on the interval $-1 \leq x \leq 1$, with $n = 0, 1, 2, \dots$. The functions $T_n(x)$ and $\sqrt{1-x^2} U_{n-1}(x)$ are two linearly independent solutions of 18.3.1.1.1.

18.3.2 Rodrigues' Formulas for $T_n(x)$ and $U_n(x)$

18.3.2.1

The Chebyshev polynomials $T_n(x)$ and $U_n(x)$ of degree n are given by **Rodrigues' formulas**:

$$1. \quad T_n(x) = \frac{(-1)^n \sqrt{\pi} (1-x^2)^{1/2}}{2^n \Gamma(n + \frac{1}{2})} \frac{d^n}{dx^n} [(1-x^2)^{n-1/2}]$$

$$2. \quad U_n(x) = \frac{(-1)^n \sqrt{\pi} (n+1) (1-x^2)^{-1/2}}{2^{n+1} \Gamma(n + \frac{3}{2})} \frac{d^n}{dx^n} [(1-x^2)^{n+1/2}]$$

18.3.3 Orthogonality Relations for $T_n(x)$ and $U_n(x)$

18.3.3.1

The **weight function** $w(x)$ for the Chebyshev polynomials $T_n(x)$ and $U_n(x)$ is $w(x) = (1-x^2)^{-1/2}$, and the **orthogonality relations** are

$$1. \int_{-1}^1 T_m(x)T_n(x)(1-x^2)^{-1/2} dx = \begin{cases} 0, & m \neq n \\ \pi/2, & m = n \neq 0 \\ \pi, & m = n = 0 \end{cases}$$

$$2. \int_{-1}^1 U_m(x)U_n(x)(1-x^2)^{1/2} dx = \begin{cases} 0, & m \neq n \\ \pi/2, & m = n \\ \pi/2, & m = n = 0 \end{cases}$$

A function $f(x)$ can be expanded over the interval $-1 \leq x \leq 1$ in terms of the Chebyshev polynomials to obtain a **Fourier-Chebyshev expansion** of the form

$$f(x) = \sum_{n=0}^{\infty} a_n T_n(x) = a_0 T_0(x) + a_1 T_1(x) + a_2 T_2(x) + \dots,$$

where the coefficients a_n are given by

$$a_n = \frac{1}{\|T_n(x)\|^2} \int_{-1}^1 \frac{f(x)T_n(x)dx}{\sqrt{1-x^2}}, \quad [n = 0, 1, 2, \dots],$$

with $\|T_0(x)\|^2 = \pi$ and $\|T_n(x)\|^2 = \frac{1}{2}\pi$ for $n = 1, 2, 3, \dots$

18.3.4 Explicit Expressions for $T_n(x)$ and $U_n(x)$

18.3.4.1

$$1. T_n(x) = \cos(n \arccos x) = \frac{1}{2} \left[(x + i\sqrt{1-x^2})^n + (x - i\sqrt{1-x^2})^n \right]$$

$$= x^n - \binom{n}{2} x^{n-2}(1-x^2) + \binom{n}{4} x^{n-4}(1-x^2)^2$$

$$- \binom{n}{6} x^{n-6}(1-x^2)^3 + \dots$$

$$2. U_n(x) = \frac{\sin[(n+1) \arccos x]}{\sin[\arccos x]}$$

$$= \frac{1}{2i\sqrt{1-x^2}} \left[(x + i\sqrt{1-x^2})^{n+1} - (x - i\sqrt{1-x^2})^{n+1} \right]$$

$$= \binom{n+1}{1} x^n - \binom{n+1}{3} x^{n-2}(1-x^2) + \binom{n+1}{5} x^{n-4}(1-x^2)^2 - \dots$$

18.3.4.2 Special Cases and Graphs of $T_n(x)$ and $U_n(x)$

1. $T_0(x) = 1$
2. $T_1(x) = x$

3. $T_2(x) = 2x^2 - 1$
4. $T_3(x) = 4x^3 - 3x$
5. $T_4(x) = 8x^4 - 8x^2 + 1$
6. $T_5(x) = 16x^5 - 20x^3 + 5x$
7. $T_6(x) = 32x^6 - 48x^4 + 18x^2 - 1$
8. $T_7(x) = 64x^7 - 112x^5 + 56x^3 - 7x$
9. $T_8(x) = 128x^8 - 256x^6 + 160x^4 - 32x^2 + 1$
10. $U_0(x) = 1$
11. $U_1(x) = 2x$
12. $U_2(x) = 4x^2 - 1$
13. $U_3(x) = 8x^3 - 4x$
14. $U_4(x) = 16x^4 - 12x^2 + 1$
15. $U_5(x) = 32x^5 - 32x^3 + 6x$
16. $U_6(x) = 64x^6 - 80x^4 + 24x^2 - 1$
17. $U_7(x) = 128x^7 - 192x^5 + 80x^3 - 8x$
18. $U_8(x) = 256x^8 - 448x^6 + 240x^4 - 40x^2 + 1$

See Figures 18.3 and 18.4.

18.3.4.3 Particular Values

1. $T_n(1) = 1$
2. $T_n(-1) = (-1)^n$
3. $T_{2n}(0) = (-1)^n$
4. $T_{2n+1}(0) = 0$
5. $U_{2n+1}(0) = 0$
6. $U_{2n}(0) = (-1)^n$

Powers of x in terms of $T_n(x)$ and $U_n(x)$

1. $1 = T_0(x)$
2. $x = T_1(x)$
3. $x^2 = \frac{1}{2}(T_2(x) + T_0(x))$
4. $x^3 = \frac{1}{4}(T_3(x) + 3T_1(x))$
5. $x^4 = \frac{1}{8}(T_4(x) + 4T_2(x) + 3T_0(x))$

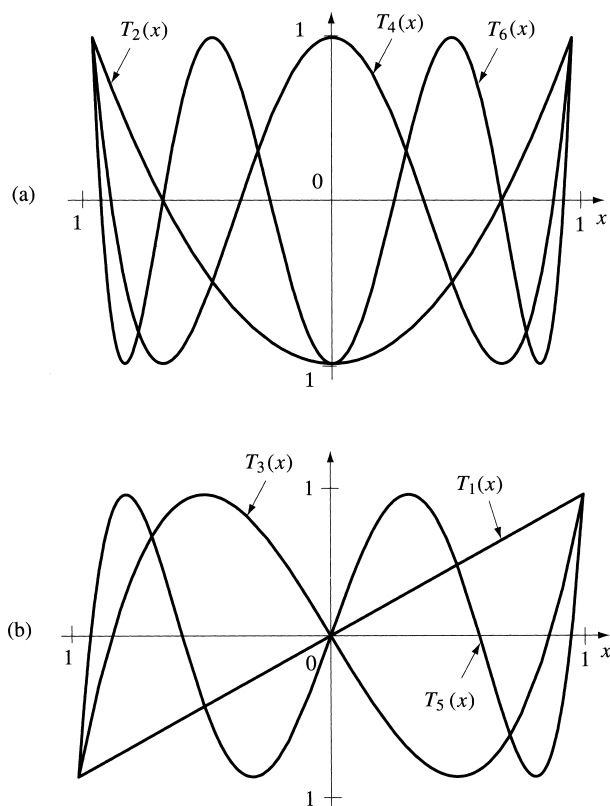

Figure 18.3. Chebyshev polynomials $T_n(x)$: (a) even polynomials and (b) odd polynomials.

$$6. \quad x^5 = \frac{1}{16}(T_5(x) + 5T_3(x) + 10T_1(x))$$

$$7. \quad x^6 = \frac{1}{32}(T_6(x) + 6T_4(x) + 15T_2(x) + 10T_0(x))$$

$$8. \quad x^7 = \frac{1}{64}(T_7(x) + 7T_5(x) + 21T_3(x) + 35T_1(x))$$

$$9. \quad x^8 = \frac{1}{128}(T_8(x) + 8T_6(x) + 28T_4(x) + 56T_2(x) + 35T_0(x))$$

$$10. \quad 1 = U_0(x)$$

$$11. \quad x = \frac{1}{2}U_1(x)$$

$$12. \quad x^2 = \frac{1}{4}(U_2(x) + U_0(x))$$

$$13. \quad x^3 = \frac{1}{8}(U_3(x) + 2U_1(x))$$

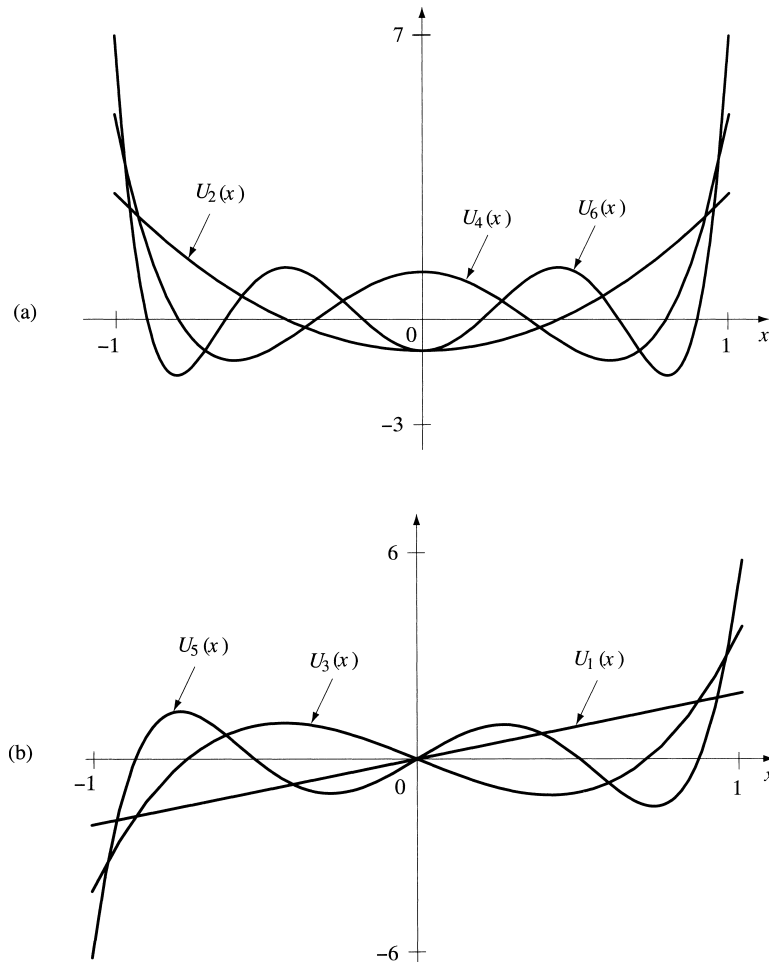

Figure 18.4. Chebyshev polynomials $U_n(x)$: (a) even polynomials and (b) odd polynomials.

$$14. \quad x^4 = \frac{1}{16} (U_4(x) + 3U_2(x) + 2U_0(x))$$

$$15. \quad x^5 = \frac{1}{32} (U_5(x) + 4U_3(x) + 5U_1(x))$$

$$16. \quad x^6 = \frac{1}{64} (U_6(x) + 5U_4(x) + 9U_2(x) + 5U_0(x))$$

$$17. \quad x^7 = \frac{1}{128} (U_7(x) + 6U_5(x) + 14U_3(x) + 14U_1(x))$$

$$18. \quad x^8 = \frac{1}{256} (U_8(x) + 7U_6(x) + 20U_4(x) + 28U_2(x) + 14U_0(x))$$

18.3.5 Recurrence Relations Satisfied by $T_n(x)$ and $U_n(x)$ **18.3.5.1**

1. $T_{n+1}(x) - 2xT_n(x) + T_{n-1}(x) = 0$
2. $U_{n+1}(x) - 2xU_n(x) + U_{n-1}(x) = 0$
3. $T_n(x) = U_n(x) - xU_{n-1}(x)$
4. $(1 - x^2)U_{n-1}(x) = xT_n(x) - T_{n+1}(x)$

18.3.6 Generating Functions for $T_n(x)$ and $U_n(x)$ **18.3.6.1**

The Chebyshev polynomials $T_n(x)$ and $U_n(x)$ occur as the multipliers of t^n in the expansions of the respective **generating functions**:

1.
$$\frac{1 - t^2}{1 - 2tx + t^2} = T_0(x) + 2 \sum_{k=1}^{\infty} T_k(x)t^k$$
2.
$$\frac{1}{1 - 2tx + t^2} = \sum_{k=0}^{\infty} U_k(x)t^k.$$

18.4 LAGUERRE POLYNOMIALS $L_n(x)$ **18.4.1 Differential Equation Satisfied by $L_n(x)$** **18.4.1.1**

The **Laguerre polynomials** $L_n(x)$ satisfy the differential equation

1. $x \frac{d^2y}{dx^2} + (1 - x) \frac{dy}{dx} + ny = 0$

defined on the interval $0 \leq x < \infty$, with $n = 0, 1, 2, \dots$

18.4.2 Rodrigues' Formula for $L_n(x)$ **18.4.2.1**

The Laguerre polynomial $L_n(x)$ of degree n is given by the following **Rodrigues' formula**:

1. $L_n(x) = \frac{e^x}{n!} \frac{d^n}{dx^n} [e^{-x} x^n]$

A definition also in use in place of 18.4.2.1.1 is

2. $L_n(x) = e^x \frac{d^n}{dx^n} [e^{-x} x^n].$

This leads to the omission of the scale factor $1/n!$ in 18.4.4.1 and to a modification of the recurrence relations in 18.4.5.1.

$$3. \quad L_n(x) = \sum_{r=0}^n (-1)^r \frac{n!x^r}{(n-r)!(r!)^2} = \sum_{m=0}^n (-1)^{n-m} \frac{n!x^{n-m}}{[(n-m)!]^2 m!}$$

18.4.3 Orthogonality Relation for $L_n(x)$

18.4.3.1

The **weight function** for Laguerre polynomials is $w(x) = e^{-x}$, and the **orthogonality relation** is

$$1. \quad \int_0^{\infty} e^{-x} L_m(x) L_n(x) dx = \begin{cases} 0, & m \neq n \\ 1, & m = n. \end{cases}$$

A function $f(x)$ can be expanded over the interval $0 \leq x < \infty$ in terms of the Laguerre polynomials to obtain a **Fourier-Laguerre expansion** of the form

$$f(x) = \sum_{n=0}^{\infty} a_n L_n(x) = a_0 L_0(x) + a_1 L_1(x) + a_2 L_2(x) + \dots,$$

where the coefficients a_n are given by

$$a_n = \int_0^{\infty} e^{-x} f(x) L_n(x) dx, \quad [n = 0, 1, 2, \dots]$$

18.4.4 Explicit Expressions for $L_n(x)$ and x^n in Terms of $L_n(x)$

18.4.4.1

1. $L_0(x) = 1$
2. $L_1(x) = 1 - x$
3. $L_2(x) = \frac{1}{2!} (2 - 4x + x^2)$
4. $L_3(x) = \frac{1}{3!} (6 - 18x + 9x^2 - x^3)$
5. $L_4(x) = \frac{1}{4!} (24 - 96x + 72x^2 - 16x^3 + x^4)$
6. $L_5(x) = \frac{1}{5!} (120 - 600x + 600x^2 - 200x^3 + 25x^4 - x^5)$
7. $L_6(x) = \frac{1}{6!} (720 - 4320x + 5400x^2 - 2400x^3 + 450x^4 - 36x^5 + x^6)$
8. $L_7(x) = \frac{1}{7!} (5040 - 35280x + 52920x^2 - 29400x^3 + 7350x^4 - 882x^5 + 49x^6 - x^7)$

9. $1 = L_0$
10. $x = L_0 - L_1$
11. $x^2 = 2L_0 - 4L_1 + 2L_2$
12. $x^3 = 6L_0 - 18L_1 + 18L_2 - 6L_3$
13. $x^4 = 24L_0 - 96L_1 + 144L_2 - 96L_3 + 24L_4$
14. $x^5 = 120L_0 - 600L_1 + 1200L_2 - 1200L_3 + 600L_4 - 120L_5$
15. $x^6 = 720L_0 - 4320L_1 + 10800L_2 - 14400L_3 + 10800L_4 - 4320L_5 + 720L_6$

18.4.5 Recurrence Relations Satisfied by $L_n(x)$

18.4.5.1

1. $(n+1)L_{n+1}(x) = (2n+1-x)L_n(x) - nL_{n-1}(x)$
2. $x \frac{d}{dx}[L_n(x)] = nL_n(x) - nL_{n-1}(x)$

18.4.6 Generating Function for $L_n(x)$

18.4.6.1

The Laguerre polynomial $L_n(x)$ occurs as the multiplier of t^n in the expansion of the **generating function**:

$$1. \quad \frac{1}{(1-t)} \exp\left(\frac{xt}{t-1}\right) = \sum_{k=0}^{\infty} L_k(x)t^k.$$

18.4.7 Integrals Involving $L_n(x)$

18.4.7.1

1. $\int_0^x L_n(t) dt = -L_{n+1}(x)$
2. $\int_0^{\infty} x^p e^{-x} L_n(x) dx = \begin{cases} 0, & p < n \\ (-1)^n n!, & p = n \end{cases}$

18.4.8 Generalized (Associated) Laguerre Polynomials $L_n^{(\alpha)}(x)$

18.4.8.1 Differential Equation Satisfied by $L_n^{(\alpha)}(x)$

The generalized Laguerre polynomial $L_n^{(\alpha)}(x)$ satisfies the differential equation

$$1. \quad x \frac{d^2 y}{dx^2} + (1 + \alpha - x) \frac{dy}{dx} + ny = 0.$$

18.4.8.2 Rodrigues' Formula for $L_n^{(\alpha)}(x)$

The generalized Laguerre polynomial $L_n^{(\alpha)}(x)$ is defined by the **Rodrigues' formula**

$$1. \quad L_n^{(\alpha)}(x) = \frac{1}{n!} e^x x^{-\alpha} \frac{d^n}{dx^n} [e^{-x} x^{n+\alpha}],$$

and when $\alpha = 0$ it follows that $L_n(x) = L_n^{(0)}(x)$, $n = 0, 1, 2, \dots$

18.4.8.3 Orthogonality Relation for $L_n^{(\alpha)}(x)$

$$1. \quad \int_0^\infty x^\alpha e^{-x} L_m^{(\alpha)}(x) L_n^{(\alpha)}(x) dx = \begin{cases} 0, & m \neq n \\ \Gamma(1 + \alpha) \binom{n + \alpha}{n}, & m = n. \end{cases}$$

18.4.8.4 Special Cases

$$1. \quad L_0^{(\alpha)}(x) = 1$$

$$2. \quad L_1^{(\alpha)}(x) = \alpha + 1 - x$$

$$3. \quad L_2^{(\alpha)}(x) = \frac{1}{2} [(\alpha + 1)(\alpha + 2) - 2(\alpha + 2)x + x^2]$$

$$4. \quad L_3^{(\alpha)}(x) = \frac{1}{6} \alpha^3 + \alpha^2 + \frac{11}{6} \alpha + 1 - \frac{1}{2} \alpha^2 x - \frac{5}{2} \alpha x - 3x + \frac{1}{2} \alpha x^2 + \frac{3}{2} x^2 - \frac{1}{6} x^3$$

$$5. \quad L_n^{(\alpha)}(0) = \binom{n + \alpha}{n}$$

$$6. \quad L_n^{(-n)}(x) = (-1)^n x^n / n!$$

18.4.8.5 Recurrence Relations Satisfied by $L_n^{(\alpha)}(x)$

$$1. \quad nL_n^{(\alpha)}(x) = (2n + \alpha - 1 - x)L_{n-1}^{(\alpha)}(x) - (n + \alpha - 1)L_{n-2}^{(\alpha)}(x), \quad n = 2, 3, \dots$$

$$2. \quad xL_n^{(\alpha+1)}(x) = (n + \alpha)L_{n-1}^{(\alpha)}(x) - (n - x)L_n^{(\alpha)}(x)$$

$$3. \quad L_n^{(\alpha)}(x) = L_n^{(\alpha+1)}(x) - L_{n-1}^{(\alpha+1)}(x)$$

$$4. \quad (n + \alpha)L_n^{(\alpha-1)}(x) = (n + 1)L_{n+1}^{(\alpha)}(x) - (n + 1 - x)L_n^{(\alpha)}(x)$$

18.4.8.6 Generating Function for $L_n^{(\alpha)}(x)$

$$1. \quad \frac{1}{(1-t)^{\alpha+1}} \exp\left[-\frac{xt}{1-t}\right] = \sum_{n=0}^{\infty} t^n L_n^{(\alpha)}(x), \quad |t| < 1$$

18.4.8.7 Differentiation Formulas for $L_n^{(\alpha)}(x)$

1. $\frac{d}{dx} [L_n^{(\alpha)}(x)] = -L_{n-1}^{(\alpha+1)}(x)$
2. $\frac{d}{dx} [x^\alpha L_n^{(\alpha)}(x)] = (n + \alpha)x^{\alpha-1} L_n^{(\alpha-1)}(x)$

18.4.8.8 Integrals Involving $L_n^{(\alpha)}(x)$

1. $\int_0^\infty e^{-x} k^{k+1} [L_n^{(\alpha)}(x)]^2 dx = \frac{(n+k)!}{n!} (2n+k+1)$
2. $\int_0^x L_n^{(\alpha)}(t) dt = -L_{n+1}^{(\alpha-1)}(x) + \frac{(\alpha)_{n+1}}{(n+1)!}$

[for the Pochhammer symbol $(a)_n$, see Section 0.3]

3. $\int_0^x t^\alpha L_n^{(\alpha)}(t) dt = \frac{1}{(n+\alpha+1)} x^{\alpha+1} L_n^{(\alpha+1)}(x)$
4. $\int_0^x e^{-t} L_n^{(\alpha)}(t) dt = e^{-x} [L_n^{(\alpha)}(x) - L_{n-1}^{(\alpha)}(x)]$

18.5 HERMITE POLYNOMIALS $H_n(x)$ **18.5.1 Differential Equation Satisfied by $H_n(x)$** **18.5.1.1**

The **Hermite polynomials** $H_n(x)$ satisfy the differential equation

1. $\frac{d^2 y}{dx^2} - 2x \frac{dy}{dx} + 2ny = 0$

defined on the interval $-\infty < x < \infty$, with $n = 0, 1, 2, \dots$

18.5.2 Rodrigues' Formula for $H_n(x)$ **18.5.2.1**

The Hermite polynomial $H_n(x)$ of degree n is given by the following Rodrigues' formula:

1. $H_n(x) = (-1)^n e^{x^2} \frac{d^n}{dx^n} [e^{-x^2}]$.

18.5.3 Orthogonality Relation for $H_n(x)$

18.5.3.1

The **weight function** $w(x)$ for the Hermite polynomials $H_n(x)$ is $w(x) = e^{-x^2}$, and the **orthogonality relation** is

$$1. \int_{-\infty}^{\infty} e^{-x^2} H_m(x) H_n(x) dx = \begin{cases} 0, & m \neq n \\ \sqrt{\pi} 2^n n!, & m = n. \end{cases}$$

A function $f(x)$ can be expanded over the interval $-\infty \leq x \leq \infty$ in terms of the Hermite polynomials to obtain a **Fourier-Hermite expansion** of the form

$$f(x) = \sum_{n=0}^{\infty} a_n H_n(x) = a_0 H_0(x) + a_1 H_1(x) + a_2 H_2(x) + \cdots,$$

where the coefficients a_n are given by

$$a_n = \frac{1}{\|H_n(x)\|^2} \int_{-\infty}^{\infty} e^{-x^2} f(x) H_n(x) dx, \quad [n = 0, 1, 2, \dots]$$

with $\|H_0(x)\|^2 = \sqrt{\pi}$ and $\|H_n(x)\|^2 = \sqrt{\pi} 2^n n!$ for $n = 1, 2, 3, \dots$

18.5.4 Explicit Expressions for $H_n(x)$

18.5.4.1

1. $H_0(x) = 1$
2. $H_1(x) = 2x$
3. $H_2(x) = 4x^2 - 2$
4. $H_3(x) = 8x^3 - 12x$
5. $H_4(x) = 16x^4 - 48x^2 + 12$
6. $H_5(x) = 32x^5 - 160x^3 + 120x$
7. $H_6(x) = 64x^6 - 480x^4 + 720x^2 - 120$
8. $H_7(x) = 128x^7 - 1344x^5 + 3360x^3 - 1680x$
9. $H_8(x) = 256x^8 - 3584x^6 + 13440x^4 - 13440x^2 + 1680$

18.5.5 Recurrence Relations Satisfied by $H_n(x)$

18.5.5.1

1. $H_{n+1}(x) = 2xH_n(x) - 2nH_{n-1}(x)$
2. $\frac{d}{dx} [H_n(x)] = 2nH_{n-1}(x)$

$$3. \quad nH_n(x) = -n \frac{d}{dx}[H_{n-1}(x)] + x \frac{d}{dx}[H_n(x)]$$

$$4. \quad H_n(x) = 2xH_{n-1}(x) - \frac{d}{dx}[H_{n-1}(x)]$$

18.5.6 Generating Function for $H_n(x)$

18.5.6.1

The Hermite polynomial $H_n(x)$ occurs as the multiplier of $t^n/n!$ in the expansion of the **generating function**:

$$1. \quad \exp(-t^2 + 2tx) = \sum_{k=0}^{\infty} H_k(x) \frac{t^k}{k!}.$$

18.5.7 Series Expansions of $H_n(x)$

$$1. \quad H_n(x) = n! \sum_{s=0}^{[n/2]} (-1)^s \frac{(2x)^{n-2s}}{(n-2s)!s!} \quad ([n/2] \text{ denotes integral part of } n/2)$$

$$2. \quad H_{2n}(x) = (-1)^n (2n)! \sum_{s=0}^n (-1)^{2s} \frac{(2x)^{2s}}{(2s)!(n-s)!}$$

$$3. \quad H_{2n+1}(x) = (-1)^n (2n+1)! \sum_{s=0}^n (-1)^s \frac{(2x)^{2s+1}}{(2s+1)!(n-s)!}$$

18.5.8 Powers of x in Terms of $H_n(x)$

$$1. \quad x^{2r} = \frac{(2r)!}{2^{2r}} \sum_{n=0}^r \frac{H_{2n}(x)}{(2n)!(r-n)!} \quad r = 0, 1, 2, \dots$$

$$2. \quad x^{2r+1} = \frac{(2r+1)!}{2^{2r+1}} \sum_{n=0}^r \frac{H_{2n+1}(x)}{(2n+1)!(r-n)!} \quad r = 0, 1, 2, \dots$$

18.5.9 Definite Integrals

$$1. \quad \int_0^x H_n(t) dt = \frac{H_{n+1}(x) - H_{n+1}(0)}{2(n+1)}$$

$$2. \quad \int_0^x \exp(-t^2) H_n(t) dt = H_{n-1}(0) - \exp(-x^2) H_{n-1}(x)$$

$$3. \quad \int_{-\infty}^{\infty} \exp\left(-\frac{1}{2}x^2\right) H_n(x) dx = \begin{cases} 2\pi n!/(n/2)! & n \text{ even} \\ 0 & n \text{ odd} \end{cases}$$

$$4. \quad \int_{-\infty}^{\infty} x \exp\left(-\frac{1}{2}x^2\right) H_n(x) dx = \begin{cases} 0 & n \text{ even} \\ \frac{2\pi(n+1)!}{[(n+1)/2]!} & n \text{ odd} \end{cases}$$

5.
$$\int_{-\infty}^{\infty} x \exp(-x^2) H_m(x) H_n(x) dx = \sqrt{\pi} [2^{n-1} n! \delta_{m,n-1} + 2^n (n+1)! \delta_{n,n+1}]$$
6.
$$\int_{-\infty}^{\infty} x^2 \exp(-x^2) [H_n(x)]^2 dx = \sqrt{\pi} 2^n n! \left(n + \frac{1}{2} \right)$$
7.
$$\begin{aligned} \int_{-\infty}^{\infty} x^2 \exp(-x^2) H_m(x) H_n(x) dx \\ = \sqrt{\pi} [2^{n-1} (2n+1) n! \delta_{n,m} + 2^n (n+2)! \delta_{n+2,m} + 2^{n-2} n! \delta_{n-2,m}] \end{aligned}$$
8.
$$\int_{-\infty}^{\infty} x^r \exp(-x^2) H_n(x) H_{n+p}(x) dx = \begin{cases} 0, & p > r \\ 2^n \sqrt{\pi} (n+r)! & p = r \end{cases}$$

[n, p, r nonnegative integers]
9.
$$\int_{-\infty}^{\infty} \exp(-t^2) H_{2n}(xt) dt = \sqrt{\pi} \frac{(2n)! (x^2 - 1)^n}{n!}$$
10.
$$\int_{-\infty}^{\infty} t \exp(-t^2) H_{2n+1}(xt) dt = \sqrt{\pi} \frac{(2n+1)! x (x^2 - 1)^n}{n!}$$
11.
$$\int_{-\infty}^{\infty} t^n \exp(-t^2) H_n(xt) dt = \sqrt{\pi} n! P_n(x)$$
12.
$$\int_0^{\infty} \exp(-t^2) [H_n(t)]^2 \cos(xt\sqrt{2}) dt = \sqrt{\pi} 2^{n-1} n! \exp(-x^2) L_n(x^2)$$

18.5.10 Asymptotic Expansion for Large n

1.
$$\begin{aligned} \frac{\Gamma(\frac{1}{2}n+1)}{\Gamma(n+1)} \exp\left(-\frac{1}{2}x^2\right) H_n(x) &= \cos\left[(2n+1)^{1/2}x - \frac{1}{2}n\pi\right] \\ &+ \frac{1}{6}x^3(2n-1)^{-1/2} \sin\left[(2n+1)^{1/2}x - \frac{1}{2}n\pi\right] + O(1/n) \end{aligned}$$

[x real, $n \rightarrow \infty$]

18.6 JACOBI POLYNOMIALS $P_n^{(\alpha, \beta)}(x)$

The Jacobi polynomial $P_n^{(\alpha, \beta)}(x)$, with $\alpha > -1$, $\beta > -1$, is an orthogonal polynomial of degree n defined over the interval $[-1, 1]$ with weight function $w(x) = (1-x)^\alpha(1+x)^\beta$, and the zeros of the polynomial are all simple and lie inside the interval $[-1, 1]$. The Jacobi polynomials are particularly useful in numerical analysis where they are used when finding highly accurate solutions of differential equations by the *spectral Galerkin method*.

18.6.1 Differential Equation Satisfied by $P_n^{(\alpha,\beta)}(x)$

The polynomials $P_n^{(\alpha,\beta)}(x)$ are the eigenfunctions of the singular Sturm-Liouville equation

$$1. \quad (1-x^2)\frac{d^2y}{dx^2} + [\beta - \alpha - (\alpha + \beta + 2)x]\frac{dy}{dx} + n(n + \alpha + \beta + 1)y = 0,$$

for $n = 0, 1, 2, \dots$ and $-1 \leq x \leq 1$, and the solutions are normalized by the condition

$$2. \quad P_n^{(\alpha,\beta)}(1) = \frac{\Gamma(n + \alpha + 1)}{n!\Gamma(\alpha + 1)}.$$

18.6.2 Rodrigues' Formula for $P_n^{(\alpha,\beta)}(x)$

$$1. \quad P_n^{(\alpha,\beta)}(x) = \frac{(-1)^n}{2^n n!} \frac{1}{(1-x)^\alpha (1+x)^\beta} \frac{d^n}{dx^n} [(1-x)^{\alpha+n} (1+x)^{\beta+n}].$$

18.6.3 Orthogonality Relation for $P_n^{(\alpha,\beta)}(x)$

$$1. \quad \int_{-1}^1 (1-x)^\alpha (1+x)^\beta P_m^{(\alpha,\beta)}(x) P_n^{(\alpha,\beta)}(x) dx = \begin{cases} 0, & m \neq n \\ h_n, & m = n, \end{cases}$$

where

$$2. \quad h_n = \frac{2^{\alpha+\beta+1} \Gamma(n + \alpha + 1) \Gamma(n + \beta + 1)}{n! (2n + \alpha + \beta + 1) \Gamma(n + \alpha + \beta + 1)}.$$

18.6.4 A Useful Integral Involving $P_n^{(\alpha,\beta)}(x)$

$$1. \quad 2n \int_0^x (1-t)^\alpha (1+t)^\beta P_n^{(\alpha,\beta)}(x) dx = P_{n-1}^{(\alpha+1,\beta+1)}(0) - (1-x)^{\alpha+1} (1+x)^{\beta+1} P_{n-1}^{(\alpha+1,\beta+1)}(x).$$

18.6.5 Explicit Expressions for $P_n^{(\alpha,\beta)}(x)$

$$1. \quad P_n^{(\alpha,\beta)}(x) = 2^{-n} \sum_{k=0}^n \binom{n+\alpha}{k} \binom{n+\beta}{n-k} (x+1)^k (x-1)^{n-k}.$$

$$2. \quad P_n^{(\alpha,\beta)}(-x) = (-1)^n P_n^{(\alpha,\beta)}(x).$$

$$3. \quad P_n^{(0,0)}(x) = P_n(x).$$

$$4. \quad P_0^{(\alpha,\beta)}(x) = 1.$$

5. $P_1^{(\alpha, \beta)}(x) = \frac{1}{2}[(\alpha - \beta) + (\alpha + \beta + 2)x].$
6. $P_2^{(\alpha, \beta)}(x) = \frac{1}{8} [(1 + \alpha)(2 + \alpha) + (1 + \beta)(2 + \beta) - 2(\alpha + 2)(\beta + 2)]$
 $+ \frac{1}{4} [(1 + \alpha)(2 + \alpha) - (1 + \beta)(2 + \beta)] x$
 $+ \frac{1}{8} [(1 + \alpha)(2 + \alpha) + (1 + \beta)(2 + \beta) + 2(2 + \alpha)(2 + \beta)] x^2.$
7. $\binom{n}{k} P_n^{(-k, \beta)}(x) = \binom{n + \beta}{k} \left(\frac{x - 1}{2}\right)^k P_{n-1}^{(k, \beta)}(x).$

18.6.6 Differentiation Formulas for $P_n^{(\alpha, \beta)}(x)$

1. $\frac{d}{dx} P_n^{(\alpha, \beta)}(x) = \left(\frac{\alpha + \beta + n + 1}{2}\right) P_{n-1}^{(\alpha+1, \beta+1)}(x).$
2. $\frac{d^m}{dx^m} P_n^{(\alpha, \beta)}(x) = 2^{-m} (\alpha + \beta + n + 1)_m P_{n-m}^{(\alpha+m, \beta+m)}(x).$
3. $(1 - x^2)(\alpha + \beta + 2n) \frac{d}{dx} P_n^{(\alpha, \beta)}(x) = n [\alpha - \beta - (\alpha + \beta + 2n)x] P_n^{(\alpha, \beta)}(x)$
 $+ 2(\alpha + n)(\beta + n) P_{n-1}^{(\alpha, \beta)}(x).$

18.6.7 Recurrence Relation Satisfied by $P_n^{(\alpha, \beta)}(x)$

1. $2(n + 1)(n + \alpha + \beta + 1)(2n + \alpha + \beta) P_{n+1}^{(\alpha, \beta)}(x) = (2n + \alpha + \beta)_3 x P_n^{(\alpha, \beta)}(x)$
 $+ (\alpha^2 - \beta^2)(2n + \alpha + \beta + 1) P_n^{(\alpha, \beta)}(x)$
 $- 2(n + \alpha)(n + \beta)(2n + \alpha + \beta + 2) P_{n-1}^{(\alpha, \beta)}(x), \text{ for } n = 1, 2, \dots$

The Jacobi polynomials can be produced from this result starting from $P_0^{(\alpha, \beta)}(x) = 1$ and $P_1^{(\alpha, \beta)}(x) = \frac{1}{2}[(\alpha - \beta) + (\alpha + \beta + 2)x].$

18.6.8 The Generating Function for $P_n^{(\alpha, \beta)}(x)$

1. $\sum_{n=0}^{\infty} P_n^{(\alpha, \beta)}(x) z^n = \frac{2^{\alpha+\beta}}{R} \frac{1}{(1 - z + R)^\alpha (1 + z + R)^\beta},$
 for $|z| < 1$ and $R = \sqrt{1 - 2xz + z^2}$, where $R = 1$ when $z = 0$.

18.6.9 Asymptotic Formula for $P_n^{(\alpha,\beta)}(x)$ for Large n

$$1. \quad P_n^{(\alpha,\beta)}(\cos \theta) = \frac{\cos \left[n + \frac{1}{2}(\alpha + \beta + 1)\theta - \frac{1}{2}(\alpha + \frac{1}{2})\pi \right]}{\sqrt{n\pi} (\sin \frac{1}{2}\theta)^{\alpha+1/2} (\cos \frac{1}{2}\theta)^{\beta+1/2}} + O(n^{-3/2})$$

for $0 < \theta < \pi$.

18.6.10 Graphs of the Jacobi Polynomials $P_n^{(\alpha,\beta)}(x)$

The form taken by the graphs of the Jacobi polynomials $P_n^{(\alpha,\beta)}(x)$ changes considerably as α and β vary, but all remain finite at $x = \pm 1$ and all have n real zeros in the interval $-1 \leq x \leq 1$. Figure 18.5 shows graphs of $P_n^{(\alpha,\beta)}(x)$ for $n = 1(1)5$ corresponding to the representative values $\alpha = 1.5$ and $\beta = -0.5$.

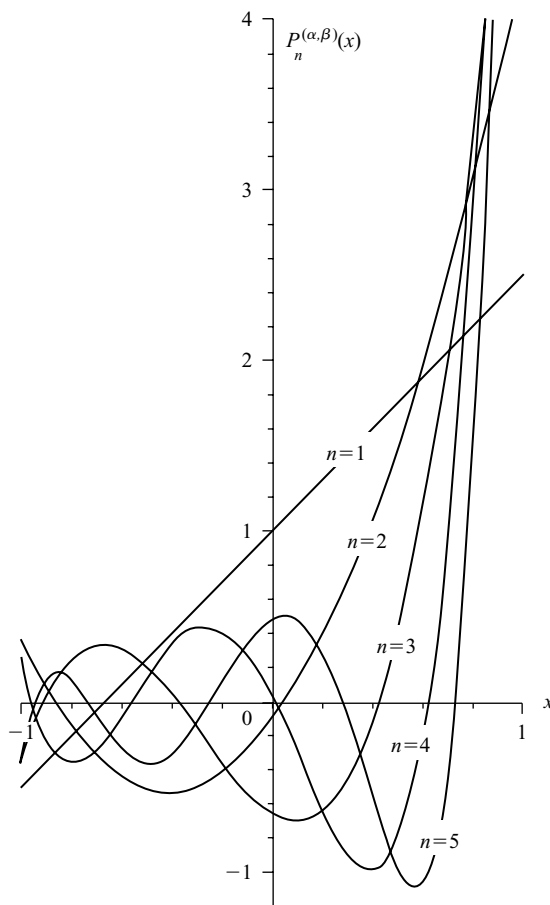
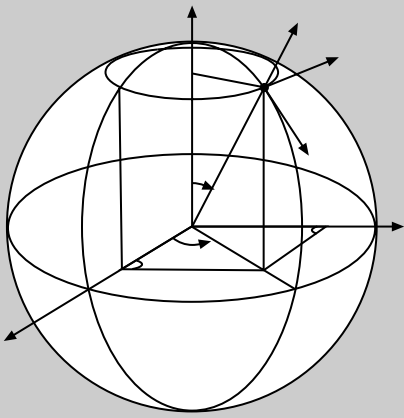

Figure 18.5. The Jacobi polynomials $J_n^{(1.5, -0.5)}(x)$ for $-1 \leq x \leq 1$ and $n = 1(1)5$.



Chapter 19

Laplace Transformation

19.1 INTRODUCTION

19.1.1 Definition of the Laplace Transform

19.1.1.1

The **Laplace transform** of the function $f(x)$, denoted by $F(s)$, is defined as the improper integral

$$1. \quad F(s) = \int_0^{\infty} f(x)e^{-sx} dx \quad [\operatorname{Re}\{s\} > 0].$$

The functions $f(x)$ and $F(x)$ are called a **Laplace transform pair**, and knowledge of either one enables the other to be recovered.

If f can be integrated over all finite intervals, and there is a constant c for which

$$2. \quad \int_0^{\infty} f(x)e^{-cx} dx,$$

is finite, then the Laplace transform exists when $s = \sigma + i\tau$ is such that $\sigma \geq c$.

Setting

$$3. \quad F(s) = \mathcal{L}[f(x); s],$$

to emphasize the nature of the transform, we have the symbolic inverse result

$$4. \quad f(x) = \mathcal{L}^{-1}[F(s); x].$$

The inversion of the Laplace transform is accomplished for analytic functions $F(s)$ that behave asymptotically like s^{-k} (or order $O(s^{-k})$) by means of the **inversion integral**

$$5. \quad f(x) = \frac{1}{2\pi i} \int_{\gamma-i\infty}^{\gamma+i\infty} F(s)e^{sx} dx,$$

where γ is a real constant that exceeds the real part of all the singularities of $F(s)$.

6. A sufficient condition, though not a necessary one, for a function $f(x)$ to have a Laplace transform $F(s) = \int_0^\infty f(x)e^{-sx} dx$ is that

$$|f(x)| \leq Me^{kx},$$

for some constants k and M . The Laplace transform then exists when $s > k$.

19.1.2 Basic Properties of the Laplace Transform

19.1.2.1

1. For a and b arbitrary constants,

$$\mathcal{L}[af(x) + bg(x); s] = aF(s) + bG(s) \quad (\text{linearity}).$$

2. If $n > 0$ is an integer and $\lim_{x \rightarrow \infty} f(x)e^{-sx} = 0$, then for $x > 0$,

$$\mathcal{L}[f^{(n)}(x); s] = s^n F(s) - s^{n-1}f(0) - s^{n-2}f^{(1)}(0) - \dots - f^{(n-1)}(0) \quad (\text{transform of a derivative}).$$

3. If $\lim_{x \rightarrow \infty} [e^{-sx} \int_0^x f(\xi) d\xi] = 0$, then

$$\mathcal{L}\left[\int_0^x f(\xi) d\xi; s\right] = \frac{1}{s}F(s) \quad (\text{transform of an integral}).$$

4. $\mathcal{L}[e^{-ax}f(x); s] = F(s+a)$ (first shift theorem).

5. Let $\mathcal{L}[f(x); s] = F(s)$ for $s > s_0$, and take $a > 0$ to be an arbitrary nonnegative number.

Then, if

$$H(x-a) = \begin{cases} 0, & x < a \\ 1, & x \geq a \end{cases}$$

is the **Heaviside step function**,

$$\mathcal{L}[H(x-a)f(x-a); s] = e^{-as}F(s) \quad [s > s_0] \quad (\text{second shift theorem}).$$

6. Let $\mathcal{L}[f(x); s] = F(s)$ for $s > s_0$. Then,

$$\mathcal{L}[(-x)^n f(x); s] = \frac{d^n}{ds^n} [F(s)] \quad [s > s_0] \quad (\text{differentiation of a transform}).$$

7. Let $f(x)$ be a piecewise-continuous function for $x \geq 0$ and periodic with period X . Then

$$\mathcal{L}[f(x); s] = \frac{1}{1 - e^{-sX}} \int_0^X f(x)e^{-sx} dx \quad (\text{transform of a periodic function}).$$

8. The **Laplace convolution** $f * g$ of two functions $f(x)$ and $g(x)$ is defined as the integral

$$f * g(x) = \int_0^x f(x - \xi)g(\xi) d\xi,$$

and it has the property that $f * g = g * f$ and $f * (g * h) = (f * g) * h$. In terms of the convolution operation

$$\mathcal{L}[f * g(x); s] = F(s)G(s) \quad [\text{convolution (Faltung) theorem}].$$

When expressed differently, if $\mathcal{L}\{f(x)\} = F(s)$ and $\mathcal{L}\{g(x)\} = G(s)$, the convolution theorem takes the form

$$\mathcal{L}\left\{\int_0^x f(\tau)g(x - \tau)d\tau\right\} = F(s)G(s),$$

and taking the inverse Laplace transform gives

$$\mathcal{L}^{-1}\{F(s)G(s)\} = \int_0^x f(\tau)g(x - \tau)d\tau. \quad [\text{inverse Laplace convolution theorem}]$$

When factoring a Laplace transform $H(s)$ into the product $F(s)G(s)$ before using the convolution theorem to find $\mathcal{L}^{-1}\{F(s)G(s)\}$, it is essential to ensure that $F(s)$ and $G(s)$ are Laplace transforms of some functions $f(x)$ and $g(x)$. This can be done by ensuring that $F(s)$ and $G(s)$ satisfy the condition in 10.

9. **Initial value theorem.** If $\mathcal{L}\{f(x)\} = F(s)$ is the Laplace transform of an n times differentiable function $f(x)$, then

$$f^{(r)}(0) = \lim_{s \rightarrow \infty} \{s^{r+1}F(s) - s^r f(0) - s^{r-1}f'(0) - \dots - sf^{(r-1)}(0)\}, \quad r = 0, 1, \dots, n.$$

In particular,

$$f(0) = \lim_{s \rightarrow \infty} \{sF(s)\} \quad \text{and} \quad f'(0) = \lim_{s \rightarrow \infty} \{s^2F(s) - sf(0)\}.$$

10. **Limiting value of $F(s)$**

For $F(s)$ to be the Laplace transform of a function $f(x)$, it is necessary that

$$\lim_{s \rightarrow \infty} F(s) = 0.$$

19.1.3 The Dirac Delta Function $\delta(x)$

19.1.3.1

The **Dirac delta function** $\delta(x)$, which is particularly useful when working with the Laplace transform, has the following properties:

1. $\delta(x - a) = 0 \quad [x \neq a]$
2. $\int_{-\infty}^{\infty} \delta(x - a) dx = 1$
3. $\int_{-\infty}^x \delta(\zeta - a) d\zeta = H(x - a),$

where $H(x - a)$ is the Heaviside step function defined in 19.1.2.1.5.

4. $\int_{-\infty}^{\infty} f(x)\delta(x - a) dx = f(a)$

The delta function, which can be regarded as an impulse function, is not a function in the usual sense, but a generalized function or distribution.

19.1.4 Laplace Transform Pairs

Table 19.1 lists Laplace transform pairs, and it can either be used to find the Laplace transform $F(s)$ of a function $f(x)$ shown in the left-hand column or, conversely, to find the inverse Laplace transform $f(x)$ of a given Laplace transform $F(s)$ shown in the right-hand column. To assist in the task of determining inverse Laplace transforms, many commonly occurring Laplace transforms $F(s)$ of an algebraic nature have been listed together with their more complicated inverse Laplace transforms $f(x)$.

The list of both Laplace transforms and inverse transforms may be extended by appeal to the theorems listed in 19.1.2.

19.1.5 Solving Initial Value Problems by the Laplace Transform

The Laplace transform is a powerful technique for solving initial value problems for linear ordinary differential equations involving an unknown function $y(t)$, provided the initial conditions are specified at $t = 0$. The restriction on the value of t at which the initial conditions must be specified is because, when transforming the differential equation, the Laplace transform of each derivative is found by using result **19.1.2.1. 2**. This result leads to the introduction of the Laplace transform $Y(s) = \mathcal{L}\{y(t)\}$ and also to terms involving the untransformed initial conditions at $t = 0$.

The Laplace transform method is particularly straightforward when solving constant coefficient differential equations. This is because it replaces by routine algebra the usual process of first determining the general solution and then matching its arbitrary constants to the given initial conditions.

The steps involved when solving a linear constant coefficient differential equation by means of the Laplace transform are as follows:

Method of Solution of an Initial Value Problem Using the Laplace Transform

Step 1. Transform a differential equation for $y(t)$, using result **19.1.2.1. 2** to transform the derivatives of $y(t)$, and substitute the values of the initial conditions at $t = 0$.

Step 2. Solve the transformed equation for $Y(s)$ to obtain a result of the form

$$Y(s) = \frac{P(s)}{Q(s)}.$$

Step 3. Find the solution $y(t)$ for $t > 0$ by inverting the Laplace transform of $Y(s)$ given by

$$y(t) = \mathcal{L}^{-1}\{P(s)/Q(s)\}.$$

Example Solve the initial value problem

$$y'' - 3y' + 2y = e^{2t} \quad \text{with} \quad y(0) = -1 \quad \text{and} \quad y'(0) = 2.$$

Solution *Step 1.* As first and second order derivatives are involved, result **19.1.2.1. 2** must be used with $n = 1$ and $n = 2$, to obtain

$$\mathcal{L}\{y'\} = sY(s) - y(0) \quad \text{and} \quad \mathcal{L}\{y''\} = s^2Y(s) - y'(0) - sy(0).$$

When the initial conditions are inserted, these transforms become $\mathcal{L}\{y'\} = sY(s) + 1$, and $\mathcal{L}\{y''\} = s^2Y(s) - 2 + s$. Using these results to transform the differential equation together with the result $\mathcal{L}\{e^{2t}\} = 1/(s - 2)$ gives

$$\underbrace{s^2Y(s) - 2 + s}_{\mathcal{L}\{y''\}} - \underbrace{3sY(s) - 3}_{-3\mathcal{L}\{y'\}} + \underbrace{2Y(s)}_{2\mathcal{L}\{y\}} = \underbrace{1/(s - 2)}_{\mathcal{L}\{e^{2t}\}}.$$

Step 2. Solving for $Y(s)$ gives

$$Y(s) = -\frac{(s^2 - 7s + 9)}{(s - 1)(s - 2)^2} = \frac{2}{s - 2} + \frac{1}{(s - 2)^2} - \frac{3}{(s - 1)}.$$

Step 3. Taking the inverse transform of $Y(s)$ by using entries in Table 19.1 gives

$$y(t) = \mathcal{L}^{-1}\{Y(s)\} = (2 + t)e^{2t} - 3e^t, \quad t > 0.$$

Notice that the Laplace transform deals automatically with the fact that the inhomogeneous term e^{2t} also appears in the complementary function of the differential equation. Had the equation been solved in the usual manner, this would have involved a special case when deriving the form of the complementary function.

Table 19.1. Table of Laplace Transform Pairs

$f(x)$	$F(s)$
1. 1	$1/s$
2. $x^n, n = 0, 1, 2, \dots$	$n!/s^{n+1}, \operatorname{Re}\{s\} > 0$
3. $x^\nu, \nu > -1$	$\Gamma(\nu + 1)/s^{\nu+1}, \operatorname{Re}\{s\} > 0$
4. $x^{n-\frac{1}{2}}$	$\left(\frac{\sqrt{\pi}}{2}\right) \left(\frac{3}{2}\right) \left(\frac{5}{2}\right) \dots \left(\frac{2n-1}{2}\right) /$ $s^{n+(1/2)}, \operatorname{Re}\{s\} > 0$
5. e^{-ax}	$1/(s+a), \operatorname{Re}\{s\} > -\operatorname{Re}\{a\}$
6. xe^{-ax}	$1/(s+a)^2, \operatorname{Re}\{s\} > -\operatorname{Re}\{a\}$
7. $(e^{-ax} - e^{-bx})/(b-a)$	$(s+a)^{-1}(s+b)^{-1}, \operatorname{Re}\{s\} >$ $\{-\operatorname{Re}\{a\}, -\operatorname{Re}\{b\}\}$
8. $(ae^{-ax} - be^{-bx})/(b-a)$	$s(s+a)^{-1}(s+b)^{-1}, -\operatorname{Re}\{s\} >$ $\{-\operatorname{Re}\{a\}, -\operatorname{Re}\{b\}\}$
9. $(e^{ax} - 1)/a$	$s^{-1}(s-a)^{-1}, \operatorname{Re}\{s\} > \operatorname{Re}\{a\}$
10. $(e^{ax} - ax - 1)/a^2$	$s^{-2}(s-a)^{-1}, \operatorname{Re}\{s\} > \operatorname{Re}\{a\}$
11. $\left(e^{ax} - \frac{1}{2}a^2x^2 - ax - 1\right)/a^3$	$s^{-3}(s-a)^{-1}, \operatorname{Re}\{s\} > \operatorname{Re}\{a\}$
12. $(1+ax)e^{ax}$	$s(s-a)^{-2}, \operatorname{Re}\{s\} > \operatorname{Re}\{a\}$
13. $[1+(ax-1)e^{ax}]/a^2$	$s^{-1}(s-a)^{-2}, \operatorname{Re}\{s\} > \operatorname{Re}\{a\}$
14. $[2+ax+(ax-2)e^{ax}]/a^3$	$s^{-2}(s-a)^{-2}, \operatorname{Re}\{s\} > \operatorname{Re}\{a\}$
15. $x^n e^{ax}, n = 0, 1, 2, \dots$	$n!(s-a)^{-(n+1)}, \operatorname{Re}\{s\} > \operatorname{Re}\{a\}$
16. $\left(x + \frac{1}{2}ax^2\right)e^{ax}$	$s(s-a)^{-3}, \operatorname{Re}\{s\} > \operatorname{Re}\{a\}$
17. $\left(1 + 2ax + \frac{1}{2}a^2x^2\right)e^{ax}$	$s^2(s-a)^{-3}, \operatorname{Re}\{s\} > \operatorname{Re}\{a\}$
18. $\frac{1}{6}x^3e^{ax}$	$(s-a)^{-4}, \operatorname{Re}\{s\} > \operatorname{Re}\{a\}$

(Continues)

Table 19.1. (Continued)

$f(x)$	$F(s)$
19. $\left(\frac{1}{2}x^2 + \frac{1}{6}ax^3\right)e^{ax}$	$s(s-a)^{-4}$, $\text{Re}\{s\} > \text{Re}\{a\}$
20. $\left(x + ax^2 + \frac{1}{6}a^2x^3\right)e^{ax}$	$s^2(s-a)^{-4}$, $\text{Re}\{s\} > \text{Re}\{a\}$
21. $\left(1 + 3ax + \frac{3}{2}a^2x^2 + \frac{1}{6}a^3x^3\right)e^{ax}$	$s^3(s-a)^{-4}$, $\text{Re}\{s\} > \text{Re}\{a\}$
22. $(ae^{ax} - be^{bx})/(a-b)$	$s(s-a)^{-1}(s-b)^{-1}$, $\text{Re}\{s\} > \{\text{Re}\{a\}, \text{Re}\{b\}\}$
23. $\left(\frac{1}{a}e^{ax} - \frac{1}{b}e^{bx} + \frac{1}{b} - \frac{1}{a}\right)/(a-b)$	$s^{-1}(s-a)^{-1}(s-b)^{-1}$, $\text{Re}\{s\} > \{\text{Re}\{a\}, \text{Re}\{b\}\}$
24. $x^{\nu-1}e^{-ax}$, $\text{Re } \nu > 0$	$\Gamma(\nu)(s+a)^{-\nu}$, $\text{Re}\{s\} > -\text{Re}\{a\}$
25. $xe^{-x^2/(4a)}$, $\text{Re}\{a\} > 0$	$2a - 2\pi^{\frac{1}{2}}a^{\frac{3}{2}}se^{as^2} \text{erfc}(sa^{\frac{1}{2}})$
26. $\sin(ax)$	$a(s^2 + a^2)^{-1}$, $\text{Re}\{s\} > \text{Im}\{a\} $
27. $\cos(ax)$	$s(s^2 + a^2)^{-1}$, $\text{Re}\{s\} > \text{Im}\{a\} $
28. $ \sin(ax) $, $a > 0$	$a(s^2 + a^2)^{-1} \coth\left(\frac{\pi s}{2a}\right)$, $\text{Re}\{s\} > 0$
29. $ \cos(ax) $, $a > 0$	$(s^2 + a^2)^{-1}$, $\left[s + a \text{csch}\left(\frac{\pi}{2a}\right)\right]$, $\text{Re}\{s\} > 0$
30. $[1 - \cos(ax)]/a^2$	$s^{-1}(s^2 + a^2)^{-1}$, $\text{Re}\{s\} > \text{Im}\{a\} $
31. $[ax - \sin(ax)]/a^3$	$s^{-2}(s^2 + a^2)^{-1}$, $\text{Re}\{s\} > \text{Im}\{a\} $
32. $[\sin(ax) - ax \cos(ax)]/(2a^3)$	$(s^2 + a^2)^{-2}$, $\text{Re}\{s\} > \text{Im}\{a\} $
33. $[x \sin(ax)]/(2a)$	$s(s^2 + a^2)^{-2}$, $\text{Re}\{s\} > \text{Im}\{a\} $
34. $[\sin(ax) + ax \cos(ax)]/(2a)$	$s^2(s^2 + a^2)^{-2}$, $\text{Re}\{s\} > \text{Im}\{a\} $
35. $x \cos(ax)$	$(s^2 - a^2)(s^2 + a^2)^{-2}$, $\text{Re}\{s\} > \text{Im}\{a\} $

(Continues)

Table 19.1. (Continued)

$f(x)$	$F(s)$
36. $[\cos(ax) - \cos(bx)]/(b^2 - a^2)$	$s(s^2 + a^2)^{-1}(s^2 + b^2)^{-1}$, $\text{Re}\{s\} > \{ \text{Im}\{a\} , \text{Im}\{b\} \}$
37. $\left[\frac{1}{2}a^2x^2 - 1 + \cos(ax)\right]/a^4$	$s^{-3}(s^2 + a^2)^{-1}$, $\text{Re}\{s\} > \text{Im}\{a\} $
38. $\left[1 - \cos(ax) - \frac{1}{2}ax \sin(ax)\right]/a^4$	$s^{-1}(s^2 + a^2)^{-2}$, $\text{Re}\{s\} > \text{Im}\{a\} $
39. $\left[\frac{1}{b} \sin(bx) - \frac{1}{a} \sin(ax)\right]/(a^2 - b^2)$	$(s^2 + a^2)^{-1}(s^2 + b^2)^{-1}$, $\text{Re}\{s\} > \{ \text{Im}\{a\} , \text{Im}\{b\} \}$
40. $\left[1 - \cos(ax) + \frac{1}{2}ax \sin(ax)\right]/a^2$	$s^{-1}(s^2 + a^2)^{-2}(2s^2 + a^2)$, $\text{Re}\{s\} > \text{Im}\{a\} $
41. $[a \sin(ax) - b \sin(bx)]/(a^2 - b^2)$	$s^2(s^2 + a^2)^{-1}(s^2 + b^2)^{-1}$, $\text{Re}\{s\} > \{ \text{Im}\{a\} , \text{Im}\{b\} \}$
42. $\sin(a + bx)$	$(s \sin a + b \cos a)(s^2 + b^2)^{-1}$, $\text{Re}\{s\} > \text{Im}\{b\} $
43. $\cos(a + bx)$	$(s \cos a - b \sin a)(s^2 + b^2)^{-1}$, $\text{Re}\{s\} > \text{Im}\{b\} $
44. $\left[\frac{1}{a} \sinh(ax) - \frac{1}{b} \sin(bx)\right]/(a^2 + b^2)$	$(s^2 - a^2)^{-1}(s^2 + b^2)^{-1}$, $\text{Re}\{s\} > \{ \text{Re}\{a\} , \text{Im}\{b\} \}$
45. $[\cosh(ax) - \cos(bx)]/(a^2 + b^2)$	$s(s^2 - a^2)^{-1}(s^2 + b^2)^{-1}$, $\text{Re}\{s\} > \{ \text{Re}\{a\} , \text{Im}\{b\} \}$
46. $[a \sinh(ax) + b \sin(bx)]/(a^2 + b^2)$	$s^2(s^2 - a^2)^{-1}(s^2 + b^2)^{-1}$, $\text{Re}\{s\} > \{ \text{Re}\{a\} , \text{Im}\{b\} \}$
47. $\sin(ax) \sin(bx)$	$2abs[s^2 + (a - b)^2]^{-1}$ $[s^2 + (a + b)^2]^{-1}$, $\text{Re}\{s\} > \{ \text{Im}\{a\} , \text{Im}\{b\} \}$
48. $\cos(ax) \cos(bx)$	$s(s^2 + a^2 + b^2)[s^2 + (a - b)^2]^{-1}$ $[s^2 + (a + b)^2]^{-1}$, $\text{Re}\{s\} > \{ \text{Im}\{a\} , \text{Im}\{b\} \}$

(Continues)

Table 19.1. (Continued)

	$f(x)$	$F(s)$
49.	$\sin(ax) \cos(bx)$	$a(s^2 + a^2 - b^2)[s^2 + (a - b)^2]^{-1}$ $[s^2 + (a + b)^2]^{-1}, \operatorname{Re}\{s\} >$ $\{ \operatorname{Im}\{a\} , \operatorname{Im}\{b\} \}$
50.	$\sin^2(ax)$	$2a^2 s^{-1}(s^2 + 4a^2)^{-1},$ $\operatorname{Re}\{s\} > \operatorname{Im}\{a\} $
51.	$\cos^2(ax)$	$(s^2 + 2a^2)s^{-1}(s^2 + 4a^2)^{-1},$ $\operatorname{Re}\{s\} > \operatorname{Im}\{a\} $
52.	$\sin(ax) \cos(ax)$	$a(s^2 + 4a^2)^{-1},$ $\operatorname{Re}\{s\} > \operatorname{Im}\{a\} $
53.	$e^{-ax} \sin(bx)$	$b[(s + a)^2 + b^2]^{-1},$ $\operatorname{Re}\{s\} > \{-\operatorname{Re}\{a\}, \operatorname{Im}\{b\} \}$
54.	$e^{-ax} \cos(bx)$	$(s + a)[(s + a)^2 + b^2]^{-1},$ $\operatorname{Re}\{s\} > \{-\operatorname{Re}\{a\}, \operatorname{Im}\{b\} \}$
55.	$\sinh(ax)$	$a(s^2 - a^2)^{-1}, \operatorname{Re}\{s\} > \operatorname{Re}\{a\} $
56.	$\cosh(ax)$	$s(s^2 - a^2)^{-1}, \operatorname{Re}\{s\} > \operatorname{Re}\{a\} $
57.	$x^{v-1} \cosh(ax), \operatorname{Re}\{v\} > 0$	$\frac{1}{2}\Gamma(v)[(s - a)^{-v} + (s + a)^{-v}],$ $\operatorname{Re}\{s\} > \operatorname{Re}\{a\} $
58.	$x \sinh(ax)$	$2as(s^2 - a^2)^{-2}, \operatorname{Re}\{s\} > \operatorname{Re}\{a\} $
59.	$x \cosh(ax)$	$(s^2 + a^2)(s^2 - a^2)^{-2},$ $\operatorname{Re}\{s\} > \operatorname{Re}\{a\} $
60.	$\sinh(ax) - \sin(ax)$	$2a^3(s^4 - a^4)^{-1},$ $\operatorname{Re}\{s\} > \{ \operatorname{Re}\{a\} , \operatorname{Im}\{a\} \}$
61.	$\cosh(ax) - \cos(ax)$	$2a^2 s(s^4 - a^4)^{-1},$ $\operatorname{Re}\{s\} > \{ \operatorname{Re}\{a\} , \operatorname{Im}\{a\} \}$
62.	$\sinh(ax) + ax \cosh(ax)$	$2as^2(a^2 - s^2)^{-2}, \operatorname{Re}\{s\} > \operatorname{Re}\{a\} $
63.	$ax \cosh(ax) - \sinh(ax)$	$2a^3(a^2 - s^2)^{-2}, \operatorname{Re}\{s\} > \operatorname{Re}\{a\} $

(Continues)

Table 19.1. (Continued)

$f(x)$	$F(s)$
64. $x \sinh(ax) - \cosh(ax)$	$s(a^2 + 2a - s^2)(a^2 - s^2)^{-2}$, $\operatorname{Re}\{s\} > \operatorname{Re}\{a\} $
65. $\left[\frac{1}{a} \sinh(ax) - \frac{1}{b} \sinh(bx) \right] / (a^2 - b^2)$	$(a^2 - s^2)^{-1}(b^2 - s^2)^{-1}$, $\operatorname{Re}\{s\} > \{ \operatorname{Re}\{a\} , \operatorname{Re}\{b\} \}$
66. $[\cosh(ax) - \cosh(bx)] / (a^2 - b^2)$	$s(s^2 - a^2)^{-1}(s^2 - b^2)^{-1}$, $\operatorname{Re}\{s\} > \{ \operatorname{Re}\{a\} , \operatorname{Re}\{b\} \}$
67. $[a \sinh(ax) - b \sinh(bx)] / (a^2 - b^2)$	$s^2(s^2 - a^2)^{-1}(s^2 - b^2)^{-1}$, $\operatorname{Re}\{s\} > \{ \operatorname{Re}\{a\} , \operatorname{Re}\{b\} \}$
68. $\sinh(a + bx)$	$(b \cosh a + s \sinh a)(s^2 - b^2)^{-1}$, $\operatorname{Re}\{s\} > \operatorname{Re}\{b\} $
69. $\cosh(a + bx)$	$(s \cosh a + b \sinh a)(s^2 - b^2)^{-1}$, $\operatorname{Re}\{s\} > \operatorname{Re}\{b\} $
70. $\sinh(ax) \sinh(bx)$	$2abs[s^2 - (a + b)^2]^{-1}$ $[s^2 - (a - b)^2]^{-1}$, $\operatorname{Re}\{s\} > \{ \operatorname{Re}\{a\} , \operatorname{Re}\{b\} \}$
71. $\cosh(ax) \cosh(bx)$	$s(s^2 - a^2 - b^2)$ $[s^2 - (a + b)^2]^{-1}[s^2 - (a - b)^2]^{-1}$, $\operatorname{Re}\{s\} > \{ \operatorname{Re}\{a\} , \operatorname{Re}\{b\} \}$
72. $\sinh(ax) \cosh(bx)$	$a(s^2 - a^2 + b^2)$ $[s^2 - (a + b)^2]^{-1}[s^2 - (a - b)^2]^{-1}$, $\operatorname{Re}\{s\} > \{ \operatorname{Re}\{a\} , \operatorname{Re}\{b\} \}$
73. $\sinh^2(ax)$	$2a^2s^{-1}(s^2 - 4a^2)^{-1}$, $\operatorname{Re}\{s\} > \operatorname{Re}\{a\} $
74. $\cosh^2(ax)$	$(s^2 - 2a^2)^{-1}(s^2 - 4a^2)^{-1}$, $\operatorname{Re}\{s\} > \operatorname{Re}\{a\} $
75. $\sinh(ax) \cosh(ax)$	$a(s^2 - 4a^2)^{-1}$, $\operatorname{Re}\{s\} > \operatorname{Re}\{a\} $
76. $[\cosh(ax) - 1]/a^2$	$s^{-1}(s^2 - a^2)^{-1}$, $\operatorname{Re}\{s\} > \operatorname{Re}\{a\} $

(Continues)

Table 19.1. (Continued)

$f(x)$	$F(s)$
77. $[\sinh(ax) - ax]/a^3$	$s^{-2}(s^2 - a^2)^{-1}$, $\operatorname{Re}\{s\} > \operatorname{Re}\{a\} $
78. $\left[\cosh(ax) - \frac{1}{2}a^2x^2 - 1\right]/a^4$	$s^{-3}(s^2 - a^2)^{-1}$, $\operatorname{Re}\{s\} > \operatorname{Re}\{a\} $
79. $\left[1 - \cosh(ax) + \frac{1}{2}ax \sinh(ax)\right]/a^4$	$s^{-1}(s^2 - a^2)^{-2}$, $\operatorname{Re}\{s\} > \operatorname{Re}\{a\} $
80. $H(x - a) = \begin{cases} 0, & x < a \\ 1, & x > a \end{cases}$ (Heaviside step function)	$s^{-1}e^{-as}$, $a \geq 0$
81. $\delta(x)$ (Dirac delta function)	1
82. $\delta(x - a)$	e^{-as} , $a \geq 0$
83. $\delta'(x - a)$	se^{-as} , $a \geq 0$
84. $\operatorname{erf}\left(\frac{x}{2a}\right) = \frac{2}{\sqrt{\pi}} \int_0^{x/(2a)} e^{-t^2} dt$	$s^{-1}e^{a^2s^2} \operatorname{erfc}(as)$, $\operatorname{Re}\{s\} > 0$, $ \arg a < \pi/4$
85. $\operatorname{erf}(a\sqrt{x})$	$as^{-1}(s + a^2)^{-1/2}$, $\operatorname{Re}\{s\} > \{0, -\operatorname{Re}\{a^2\}\}$
86. $\operatorname{erfc}(a\sqrt{x})$	$1 - a(s + a^2)^{-1/2}$, $\operatorname{Re}\{s\} > 0$
87. $\operatorname{erfc}(a/\sqrt{x})$	$s^{-1}e^{-2\sqrt{s}}$, $\operatorname{Re}\{s\} > 0$, $\operatorname{Re}\{a\} > 0$
88. $J_\nu(ax)$	$a^{-\nu}[(s^2 + a^2)^{1/2} - s]^\nu$ $(s^2 + a^2)^{-1/2}$, $\operatorname{Re}\{s\} >$ $ \operatorname{Im}\{a\} $, $\operatorname{Re}\{\nu\} > -1$
89. $x J_\nu(ax)$	$a^\nu[s + \nu(s^2 + a^2)^{1/2}]$ $[s + (s^2 + a^2)^{1/2}]^{-\nu}$, $(s^2 + a^2)^{-3/2}$, $\operatorname{Re}\{s\} > \operatorname{Im}\{a\} $, $\operatorname{Re}\{\nu\} > -2$
90. $x^{-1}J_\nu(ax)$	$a^\nu \nu^{-1}[s + (s^2 + a^2)^{1/2}]^{-\nu}$, $\operatorname{Re}\{s\} \geq \operatorname{Im}\{a\} $
91. $x^n J_n(ax)$	$1 \cdot 3 \cdot 5 \cdots (2n - 1)a^n$ $(s^2 + a^2)^{-(n+1/2)}$, $\operatorname{Re}\{s\} \geq \operatorname{Im}\{a\} $

(Continues)

Table 19.1. (Continued)

$f(x)$	$F(s)$
92. $x^\nu J_\nu(ax)$	$2^\nu \pi^{-1/2} \Gamma\left(\nu + \frac{1}{2}\right) a^\nu$ $(s^2 + a^2)^{-(\nu+1/2)} \operatorname{Re}\{s\} >$ $ \operatorname{Im}\{a\} , \operatorname{Re}\{\nu\} > -\frac{1}{2}$
93. $x^{\nu+1} J_\nu(ax)$	$2^{\nu+1} \pi^{-1/2} \Gamma\left(\nu + \frac{3}{2}\right) a^\nu s$ $(s^2 + a^2)^{-(\nu+3/2)}, \operatorname{Re}\{s\} >$ $ \operatorname{Im}\{a\} , \operatorname{Re}\{\nu\} > -1$
94. $I_0(ax)$	$1/(s^2 - a^2)^{1/2}, \operatorname{Re}\{s\} > \operatorname{Re}\{a\}$
95. $I_1(ax)$	$[s - (s^2 - a^2)^{1/2}]/[a(s^2 - a^2)^{1/2}]$ $\operatorname{Re}\{s\} > \operatorname{Re}\{a\}$
96. $I_2(ax)$	$[s - (s^2 - a^2)^{1/2}]^2/[a^2(s^2 - a^2)^{1/2}]$ $\operatorname{Re}\{s\} > \operatorname{Re}\{a\}$
97. $xI_0(ax)$	$s/(s^2 - a^2)^{3/2} \operatorname{Re}\{s\} > \operatorname{Re}\{a\}$
98. $xI_1(ax)$	$a/(s^2 - a^2)^{3/2} \operatorname{Re}\{s\} > \operatorname{Re}\{a\}$
99. $x^2 I_2(ax)$	$3a^2/(s^2 - a^2)^{5/2} \operatorname{Re}\{s\} > \operatorname{Re}\{a\}$
100. $(1/x)I_1(ax)$	$[s - (s^2 - a^2)^{1/2}]/a$ $\operatorname{Re}\{s\} > \operatorname{Re}\{a\}$
101. $(1/x)I_2(ax)$	$[s - (s^2 - a^2)^{1/2}]^2/(2a^2)$ $\operatorname{Re}\{s\} > \operatorname{Re}\{a\}$
102. $(1/x)I_3(ax)$	$[s - (s^2 - a^2)^{1/2}]^3/(3a^3)$ $\operatorname{Re}\{s\} > \operatorname{Re}\{a\}$
103. $J_0(ax) - axJ_1(ax)$	$s^2(s^2 + a^2)^{-3/2} \operatorname{Re}\{s\} > \operatorname{Im}\{a\} $
104. $I_0(ax) + axI_1(ax)$	$s^2(s^2 - a^2)^{-3/2} \operatorname{Re}\{s\} > \operatorname{Im}\{a\} $

(Continues)

Table 19.1. (Continued)

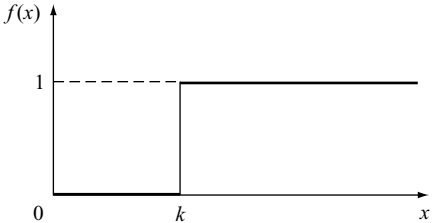
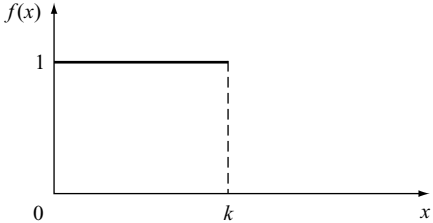
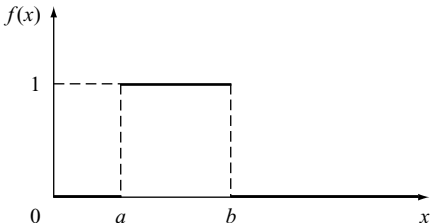
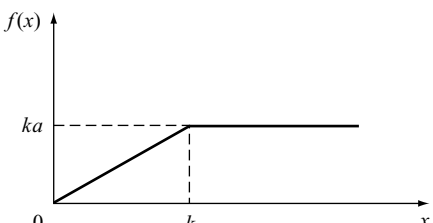
$f(x)$	$F(s)$
Fig. 105. $\mathcal{L}\{f(x)\} = e^{-ks}/s$	
Fig. 106. $\mathcal{L}\{f(x)\} = (1 - e^{-ks})/s$	
Fig. 107. $\mathcal{L}\{f(x)\} = (e^{-as} - e^{-bs})/s$	
Fig. 108. $\mathcal{L}\{f(x)\} = a(1 - e^{-ks})/s^2$	

(Continues)

Table 19.1. (Continued)

$f(x)$	$F(s)$
Fig. 109. $\mathcal{L}\{f(x)\} = [1 + \coth(\frac{1}{2}ks)] / (2s)$	
Fig. 110. $\mathcal{L}\{f(x)\} = \tanh(ks) / (2s)$	
Fig. 111. $\mathcal{L}\{f(x)\} = 1 / [s(1 + e^{-ks})]$	
Fig. 112. $\mathcal{L}\{f(x)\} = [\tanh(ks)] / s^2$	

(Continues)

Table 19.1. (Continued)

$f(x)$	$F(s)$
<p>Fig. 113. $\mathcal{L}\{f(x)\} = 1/[s \cosh(ks)]$</p>	
<p>Fig. 114. $\mathcal{L}\{f(x)\} = (a/k) (1/s^2 - ke^{-ks}/[s(1 - e^{ks})])$</p>	
<p>Fig. 115. $\mathcal{L}\{f(x)\} = (a/k) (1 - 2kse^{-ks} - e^{-2ks})/[s^2(1 - e^{-2ks})]$</p>	
<p>Fig. 116. $\mathcal{L}\{f(x)\} = [\tanh(\frac{1}{2}ks)]/(ks^2)$</p>	

(Continues)

Table 19.1. (Continued)

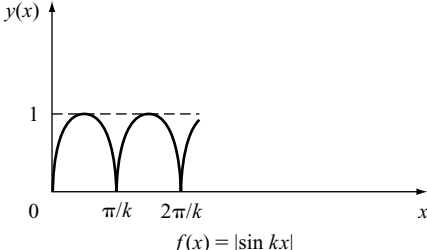
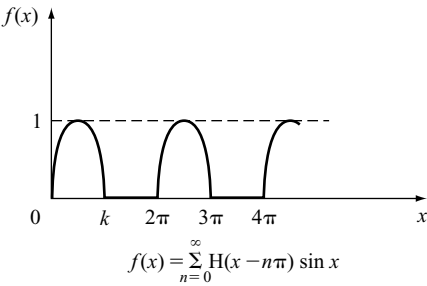
$f(x)$	$F(s)$
Fig. 117. $\mathcal{L}\{f(x)\} = [k \coth(\pi s/2k)]/(s^2 + k^2)$	 <p style="text-align: center;">$f(x) = \sin kx$</p>
Fig. 118. $\mathcal{L}\{f(x)\} = 1/[(s^2 + 1)(1 - e^{-ks})]$	 <p style="text-align: center;">$f(x) = \sum_{n=0}^{\infty} H(x - n\pi) \sin x$</p>

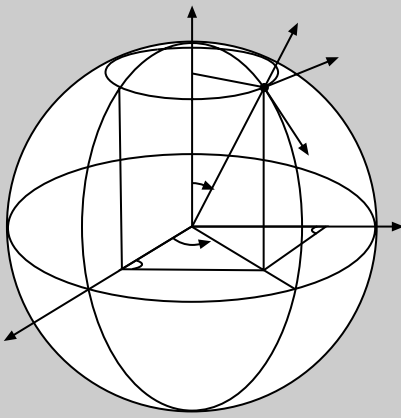

Chapter 20

Fourier Transforms

20.1 INTRODUCTION

20.1.1 Fourier Exponential Transform

20.1.1.1

Let $f(x)$ be a bounded function such that in any interval (a, b) it has only a finite number of maxima and minima and a finite number of discontinuities (it satisfies the **Dirichlet conditions**). Then if $f(x)$ is absolutely integrable on $(-\infty, \infty)$, so that

$$\int_{-\infty}^{\infty} |f(x)| dx < \infty,$$

the **Fourier transform** of $f(x)$, also called the **exponential Fourier transform**, is the $F(\omega)$ defined as

$$1. \quad F(\omega) = \frac{1}{\sqrt{2\pi}} \int_{-\infty}^{\infty} f(x) e^{i\omega x} dx.$$

The functions $f(x)$ and $F(\omega)$ are called a **Fourier transform pair**, and knowledge of either one enables the other to be recovered.

Setting

$$2. \quad F(\omega) = \mathcal{F}[f(x); \omega],$$

where \mathcal{F} is used to denote the operation of finding the Fourier transform, we have the symbolic inverse result

$$3. \quad f(x) = \mathcal{F}^{-1}[f(\omega); x].$$

The inversion of the Fourier transform is accomplished by means of the **inversion integral**

$$4. \quad \frac{1}{2} [f(x+) + f(x-)] = \frac{1}{\sqrt{2\pi}} \int_{-\infty}^{\infty} F(\omega) e^{-i\omega x} d\omega,$$

where $f(a+)$ and $f(a-)$ signify the values of $f(x)$ to the immediate right and left, respectively, of $x = a$.

At points of continuity of $f(x)$ the above result reduces to

$$5. \quad f(x) = \frac{1}{\sqrt{2\pi}} \int_{-\infty}^{\infty} F(\omega) e^{-i\omega x} d\omega.$$

20.1.2 Basic Properties of the Fourier Transforms

20.1.2.1

- For a, b arbitrary constants and $f(x), g(x)$ functions with the respective Fourier transforms $F(\omega), G(\omega)$,

$$\mathcal{F}[af(x) + bg(x); \omega] = aF(\omega) + bG(\omega) \quad (\text{linearity}).$$

- If $a \neq 0$ is an arbitrary constant, then

$$\mathcal{F}[f(ax); \omega] = \frac{1}{|a|} F\left(\frac{\omega}{a}\right) \quad (\text{scaling}).$$

- For any real constant a

$$\mathcal{F}[f(x - a); \omega] = e^{i\omega a} F(\omega) \quad (\text{spatial shift}).$$

- For any real constant a

$$\mathcal{F}[e^{iax} f(x); \omega] = F(\omega + a) \quad (\text{frequency shift}).$$

- If $n > 0$ is an integer, $f^{(n)}(x)$ is piecewise-continuously differentiable, and each of the derivatives $f^{(r)}(x)$ with $r = 0, 1, \dots, n$ is absolutely integrable for $-\infty < x < \infty$, then

$$\mathcal{F}[f^{(n)}(x); \omega] = (-i\omega)^n F(\omega) \quad (\text{differentiation}).$$

- $\int_{-\infty}^{\infty} |F(\omega)|^2 d\omega = \int_{-\infty}^{\infty} |f(x)|^2 dx.$ (Parseval's relation).

- The **Fourier convolution** of two integrable functions $f(x)$ and $g(x)$ is defined as

$$f * (g(x)) = \frac{1}{\sqrt{2\pi}} \int_{-\infty}^{\infty} f(x - u)g(u) du,$$

and it has the following properties

- (i) $f * (kg(x)) = (kf) * (g(x)) = kf * (g(x))$ (scaling; $k = \text{const.}$)
(ii) $f * (g(x) + h(x)) = f * (g(x)) + f * (h(x))$ (linearity)
(iii) $f * (g(x)) = g * (f(x))$ (commutability)

If $f(x)$, $g(x)$ have the respective Fourier transforms $F(\omega)$, $G(\omega)$,

$$\mathcal{F}[f * (g(x)); \omega] = F(\omega)G(\omega) \quad [\text{convolution (Faltung) theorem}].$$

Taking the inverse Fourier transform of the above result gives

$$\mathcal{F}^{-1}\{F(\omega)G(\omega)\} = \frac{1}{\sqrt{2\pi}} \int_{-\infty}^{\infty} f(x-\omega)g(\omega)d\omega = \frac{1}{\sqrt{2\pi}} \int_{-\infty}^{\infty} f(\omega)g(x-\omega)d\omega$$

[inverse Fourier convolution theorem].

20.1.3 Fourier Transform Pairs

20.1.3.1

Table 20.1 lists some elementary Fourier transform pairs, and it may either be used to find the Fourier transform $F(\omega)$ of a function $f(x)$ shown in the left-hand column or, conversely, to find the inverse Fourier transform $f(x)$ of a given Fourier transform $F(\omega)$ shown in the right-hand column. The list may be extended by appeal to the properties given in 20.1.2.

Care is necessary when using general tables of Fourier transform pairs because of the different choices made for the numerical normalization factors multiplying the integrals, and the signs of the exponents in the integrands. The product of the numerical factors multiplying the transform and its inverse need only equal $1/(2\pi)$, so the Fourier transform and its inverse may be defined as

- $F(\omega) = \frac{\alpha}{2\pi} \int_{-\infty}^{\infty} f(x)e^{i\omega x} dx$

and

- $\frac{1}{2} [f(x+) + f(x-)] = \frac{1}{\alpha} \int_{-\infty}^{\infty} F(\omega)e^{-i\omega x} d\omega,$

where α is an arbitrary real number. Throughout this section we have set $\alpha = \sqrt{2\pi}$, but other reference works set $\alpha = 2\pi$ or $\alpha = 1$. Another difference in the notation used elsewhere involves the choice of the sign prefixing i in 20.1.3.1.1 and 20.1.3.1.2, which is sometimes reversed.

In many physical applications of the Fourier integral it is convenient to write $\omega = 2\pi n$ and $\alpha = 2\pi$, when 20.1.3.1.1 and 20.1.3.1.2 become

- $F(n) = \int_{-\infty}^{\infty} f(x) e^{2\pi inx} dx$

and

- $\frac{1}{2} [f(x+) + f(x-)] = \int_{-\infty}^{\infty} F(n)e^{-2\pi inx} dn.$

Table 20.1. Table of Fourier Transform Pairs

$f(x) = \frac{1}{\sqrt{2\pi}} \int_{-\infty}^{\infty} F(\omega) e^{-i\omega x} d\omega$	$F(\omega) = \frac{1}{\sqrt{2\pi}} \int_{-\infty}^{\infty} f(x) e^{i\omega x} dx$
1. $\frac{1}{a^2 + x^2} \quad [a > 0]$	$\sqrt{\frac{\pi}{2}} \frac{e^{-a \omega }}{a}$
2. $\frac{x}{a^2 + x^2} \quad [a > 0]$	$-\frac{i}{2} \sqrt{\frac{\pi}{2}} \frac{\omega e^{-a \omega }}{a}$
3. $\frac{1}{x(a^2 + x^2)}$	$\sqrt{\frac{\pi}{2}} \frac{i(1 - e^{-\omega a })}{a^2}$
4. $f(x) = \begin{cases} 1, & x < a \\ 0, & x > a \end{cases}$	$\sqrt{\frac{2}{\pi}} \frac{\sin a\omega}{\omega}$
5. $\frac{1}{x}$	$i\sqrt{\frac{\pi}{2}} \operatorname{sgn}(\omega)$
6. $\frac{1}{ x }$	$\frac{1}{ \omega }$
7. $H(x - a) - H(x - b)$	$\frac{1}{i\omega\sqrt{2\pi}} (e^{ib\omega} - e^{ia\omega})$
8. $x^n \operatorname{sgn}(x) \quad [n \text{ a positive integer}]$	$\sqrt{\frac{2}{\pi}} \frac{n!}{(-i\omega)^{n+1}}$
9. $ x ^a \quad [a < 1 \text{ not a negative integer}]$	$\sqrt{\frac{2}{\pi}} \frac{\Gamma(a+1)}{ \omega ^{a+1}} \cos\left[\frac{\pi}{2}(a+1)\right]$
10. $x^a H(x) \quad [a < 1 \text{ not a negative integer}]$	$\frac{\Gamma(a+1) \exp[-\pi i(a+1) \operatorname{sgn}(\omega)]}{\sqrt{2\pi} \omega ^{a+1}}$
11. $e^{-a x } \quad [a > 0]$	$\sqrt{\frac{2}{\pi}} \frac{a}{a^2 + \omega^2}$
12. $xe^{-a x } \quad [a > 0]$	$\sqrt{\frac{2}{\pi}} \frac{2ia\omega}{(a^2 + \omega^2)^2}$
13. $ x e^{-a x } \quad [a > 0]$	$\sqrt{\frac{2}{\pi}} \frac{a^2 - \omega^2}{(a^2 + \omega^2)^2}$
14. $e^{-ax} H(x) \quad [a > 0]$	$\frac{1}{\sqrt{2\pi}} \frac{1}{a - i\omega}$
15. $e^{ax} H(-x) \quad [a > 0]$	$\frac{1}{\sqrt{2\pi}} \frac{1}{a + i\omega}$
16. $xe^{-ax} H(x) \quad [a > 0]$	$\frac{1}{\sqrt{2\pi}} \frac{1}{(a - i\omega)^2}$

(Continues)

Table 20.1. (Continued)

$f(x) = \frac{1}{\sqrt{2\pi}} \int_{-\infty}^{\infty} F(\omega) e^{-i\omega x} d\omega$	$F(\omega) = \frac{1}{\sqrt{2\pi}} \int_{-\infty}^{\infty} f(x) e^{i\omega x} dx$
17. $-xe^{ax}H(-x) \quad [a > 0]$	$\frac{1}{\sqrt{2\pi}} \frac{1}{(a + i\omega)^2}$
18. $e^{-a^2x^2} \quad [a > 0]$	$\frac{1}{a\sqrt{2}} e^{-\omega^2/(4a^2)}$
19. $\delta(x - a)$	$\frac{1}{\sqrt{2\pi}} e^{-i\omega a}$
20. $\delta(px + q) \quad [p \neq 0]$	$\frac{1}{ p } \frac{1}{\sqrt{2\pi}} e^{-iq\omega/p}$
21. $\cos(ax^2)$	$\frac{1}{\sqrt{2a}} \cos\left(\frac{\omega^2}{4a} - \frac{\pi}{4}\right)$
22. $\sin(ax^2)$	$\frac{1}{\sqrt{2a}} \sin\left(\frac{\omega^2}{4a} + \frac{\pi}{4}\right)$
23. $x \operatorname{csch} x$	$\frac{\sqrt{(2\pi^3)}}{(1 + e^{\pi\omega})^2} e^{\pi\omega}$
24. $\operatorname{sech}(ax) \quad [a > 0]$	$\frac{1}{a} \sqrt{\frac{\pi}{2}} \operatorname{sech}\left(\frac{\pi\omega}{2a}\right)$
25. $\tanh(ax) \quad [a > 0]$	$\frac{i}{a} \sqrt{\frac{\pi}{2}} \operatorname{csch}\left(\frac{\pi\omega}{2a}\right)$
26. $\sqrt{x} J_{-1/4}\left(\frac{1}{2}x^2\right)$	$\sqrt{\omega} J_{-1/4}\left(\frac{1}{2}\omega^2\right)$
27. $1/(1 + x^4)$	$\frac{1}{2} \sqrt{\pi} e^{- \omega /\sqrt{2}} \left(\cos \frac{\omega}{\sqrt{2}} + \sin \frac{ \omega }{\sqrt{2}} \right)$

20.1.4 Fourier Cosine and Sine Transforms

20.1.4.1

When a function $f(x)$ satisfies the Dirichlet conditions of 20.1.1, and it is either an even function or it is only defined for positive values of x , its Fourier cosine transform is defined as

$$1. \quad F_c(\omega) = \sqrt{\frac{2}{\pi}} \int_0^{\infty} f(x) \cos(\omega x) dx,$$

and we write

$$2. \quad F_c(\omega) = \mathcal{F}_c[f(x); \omega].$$

The functions $f(x)$ and $F_c(\omega)$ are called a **Fourier cosine transform pair**, and knowledge of either one enables the other to be recovered.

The **inversion integral** for the Fourier cosine transform is

$$3. \quad f(x) = \sqrt{\frac{2}{\pi}} \int_0^{\infty} F_c(\omega) \cos(\omega x) d\omega \quad [x > 0].$$

Similarly, if $f(x)$ is either an odd function or it is only defined for positive values of x , its **Fourier sine transform** is defined as

$$4. \quad F_s(\omega) = \sqrt{\frac{2}{\pi}} \int_0^{\infty} f(x) \sin(\omega x) dx,$$

and we write

$$5. \quad F_s(\omega) = \mathcal{F}_s[f(x); \omega].$$

The functions $f(x)$ and $F_s(\omega)$ are called a **Fourier sine transform pair** and knowledge of either one enables the other to be recovered. The **inversion integral** for the Fourier sine transform is

$$6. \quad f(x) = \sqrt{\frac{2}{\pi}} \int_0^{\infty} F_s(\omega) \sin(\omega x) d\omega \quad [x > 0].$$

20.1.5 Basic Properties of the Fourier Cosine and Sine Transforms

20.1.5.1

- For a, b arbitrary constants and $f(x), g(x)$ functions with the respective Fourier cosine and sine transforms $F_c(\omega), G_c(\omega), F_s(\omega), G_s(\omega)$,

$$\begin{aligned} \mathcal{F}_c[af(x) + bg(x)] &= aF_c(\omega) + bG_c(\omega) \\ \mathcal{F}_s[af(x) + bg(x)] &= aF_s(\omega) + bG_s(\omega) \end{aligned} \quad (\text{linearity}).$$

- If $a > 0$, then

$$\begin{aligned} \mathcal{F}_c[f(ax); \omega] &= \frac{1}{a} F_c\left(\frac{\omega}{a}\right) \\ \mathcal{F}_s[f(ax); \omega] &= \frac{1}{a} F_s\left(\frac{\omega}{a}\right) \end{aligned} \quad (\text{scaling}).$$

- $\mathcal{F}_s[\cos(ax)f(x); \omega] = \frac{1}{2} [F_s(\omega + a) + F_s(\omega - a)]$

$$\mathcal{F}_s[\sin(ax)f(x); \omega] = \frac{1}{2} [F_c(\omega - a) - F_c(\omega + a)]$$

$$\mathcal{F}_c[\cos(ax)f(x); \omega] = \frac{1}{2} [F_c(\omega + a) + F_c(\omega - a)]$$

$$\mathcal{F}_c[\sin(ax)f(x); \omega] = \frac{1}{2} [F_s(a + \omega) + F_s(a - \omega)] \quad (\text{frequency shift}).$$

$$4. \quad \mathcal{F}_c[f'(x); \omega] = \omega F_s(\omega) - \sqrt{\frac{2}{\pi}} f(0)$$

$$\mathcal{F}_s[f'(x); \omega] = -\omega F_c(\omega) \quad \text{(differentiation).}$$

$$5. \quad \mathcal{F}_c^{-1} = \mathcal{F}_c$$

$$\mathcal{F}_s^{-1} = \mathcal{F}_s \quad \text{(symmetry).}$$

$$6. \quad \int_0^\infty |F_c(\omega)|^2 d\omega = \int_0^\infty |f(x)|^2 dx$$

$$\int_0^\infty |F_s(\omega)|^2 d\omega = \int_0^\infty |f(x)|^2 dx \quad \text{(Parseval's relation).}$$

20.1.6 Fourier Cosine and Sine Transform Pairs

20.1.6.1

Tables 20.2 and 20.3 list some elementary Fourier cosine and sine transform pairs, and they may either be used to find the required transform of a function $f(x)$ in the left-hand column or, conversely, given either $F_c(\omega)$ or $F_s(\omega)$, to find the corresponding inverse transform $f(x)$.

Tables 20.2 and 20.3 may be extended by use of the properties listed in 20.1.5. As with the exponential Fourier transform, care must be taken when using other reference works because of the use of different choices for the normalizing factors multiplying the Fourier cosine and sine transforms and their inverses. The product of the normalizing factors multiplying either the Fourier cosine or sine transform and the corresponding inverse transform is $2/\pi$.

Table 20.2. Table of Fourier Cosine Pairs

$f(x) = \sqrt{\frac{2}{\pi}} \int_0^\infty F_c(\omega) \cos(\omega x) d\omega$	$F_c(\omega) = \sqrt{\frac{2}{\pi}} \int_0^\infty f(x) \cos(\omega x) dx$
1. $1/\sqrt{x}$	$1/\sqrt{\omega}$
2. $x^{a-1} \quad [0 < a < 1]$	$\sqrt{\frac{2}{\pi}} \frac{\Gamma(a) \cos(a\pi/2)}{\omega^a}$
3. $f(x) = \begin{cases} 1, & 0 < x < a \\ 0, & x > a \end{cases}$	$\sqrt{\frac{2}{\pi}} \frac{\sin(a\omega)}{\omega}$
4. $\frac{1}{a^2 + x^2} \quad [a > 0]$	$\sqrt{\frac{\pi}{2}} \frac{e^{-a\omega}}{a}$
5. $\frac{1}{(a^2 + x^2)^2} \quad [a > 0]$	$\frac{1}{2} \sqrt{\frac{\pi}{2}} \frac{e^{-a\omega} (1 + a\omega)}{a^3}$

(Continues)

Table 20.2. (Continued)

$f(x) = \sqrt{\frac{2}{\pi}} \int_0^\infty F_c(\omega) \cos(\omega x) d\omega$		$F_c(\omega) = \sqrt{\frac{2}{\pi}} \int_0^\infty f(x) \cos(\omega x) dx$	
6.	$e^{-ax} \quad [a > 0]$		$\sqrt{\frac{2}{\pi}} \frac{a}{a^2 + \omega^2}$
7.	$xe^{-ax} \quad [a > 0]$		$\sqrt{\frac{2}{\pi}} \frac{a^2 - \omega^2}{(a^2 + \omega^2)^2}$
8.	$x^{n-1}e^{-ax} \quad [a > 0, n > 0]$		$\sqrt{\frac{2}{\pi}} \frac{\Gamma(n) \cos[n \arctan(\omega/a)]}{(a^2 + \omega^2)^{n/2}}$
9.	$e^{-a^2x^2}$		$\frac{1}{ a \sqrt{2}} e^{-\omega^2/(4a^2)}$
10.	$\cos(ax)^2 \quad [a > 0]$		$\frac{1}{2} \frac{1}{\sqrt{a}} \left[\cos \frac{\omega^2}{4a} + \sin \frac{\omega^2}{4a} \right]$
11.	$\sin(ax)^2 \quad [a > 0]$		$\frac{1}{2} \frac{1}{\sqrt{a}} \left[\cos \frac{\omega^2}{4a} - \sin \frac{\omega^2}{4a} \right]$
12.	$\operatorname{sech}(ax) \quad [a > 0]$		$\sqrt{\frac{\pi}{2}} \frac{\operatorname{sech}(\pi\omega/2a)}{a}$
13.	$x \operatorname{csch} x$		$\sqrt{2\pi^3} \frac{e^{\pi\omega}}{(1 + e^{\pi\omega})^2}$
14.	$\frac{e^{-bx} - e^{-ax}}{x} \quad [a > b]$		$\frac{1}{\sqrt{2\pi}} \ln \left(\frac{a^2 + \omega^2}{b^2 + \omega^2} \right)$
15.	$\frac{\sin(ax)}{x} \quad [a > 0]$		$\begin{cases} \sqrt{\frac{\pi}{2}}, & \omega < a \\ \frac{1}{2} \sqrt{\frac{\pi}{2}}, & \omega = a \\ 0, & \omega > a \end{cases}$
16.	$\frac{\sinh(ax)}{\sinh(bx)} \quad [0 < a < b]$		$\frac{1}{b} \sqrt{\frac{\pi}{2}} \frac{\sin(\pi a/b)}{\cosh(\pi\omega/b) + \cos(\pi\omega/b)}$
17.	$\frac{\cosh(ax)}{\cosh(bx)} \quad [0 < a < b]$		$\frac{\sqrt{2\pi}}{b} \frac{\cos(\pi a/2b) \cosh(\pi\omega/2b)}{\cosh(\pi\omega/b) + \cos(\pi\omega/b)}$
18.	$\frac{J_0(ax)}{b^2 + x^2} \quad [a, b > 0]$		$\sqrt{\frac{\pi}{2}} \frac{e^{-b\omega} I_0(ab)}{b} \quad (\omega > a)$

Table 20.3. Table of Fourier Sine Pairs

$f(x) = \sqrt{\frac{2}{\pi}} \int_0^\infty F_s(\omega) \sin \omega x \, d\omega$	$F_s(\omega) = \sqrt{\frac{2}{\pi}} \int_0^\infty f(x) \sin \omega x \, dx$
1. $1/\sqrt{x}$	$1/\sqrt{\omega}$
2. $x^{a-1} \quad [0 < a < 1]$	$\sqrt{\frac{2}{\pi}} \frac{\Gamma(a) \sin(a\pi/2)}{\omega^a}$
3. $f(x) = \begin{cases} 1, & 0 < x < a \\ 0, & x > a \end{cases}$	$\sqrt{\frac{2}{\pi}} \frac{1 - \cos(a\omega)}{\omega}$
4. $1/x$	$\sqrt{\frac{\pi}{2}} \operatorname{sgn}(\omega)$
5. $\frac{x}{a^2 + x^2} \quad [a > 0]$	$\sqrt{\frac{\pi}{2}} e^{-a\omega} \quad [\omega > 0]$
6. $\frac{x}{(a^2 + x^2)^2} \quad [a > 0]$	$\sqrt{\frac{\pi}{8}} \frac{\omega e^{-a\omega}}{a} \quad [\omega > 0]$
7. $\frac{1}{x(a^2 + x^2)}$	$\sqrt{\frac{\pi}{2}} \frac{(1 - e^{-\omega a })}{a^2} \operatorname{sgn}(\omega)$
8. $\frac{x^2 - a^2}{x(x^2 + a^2)}$	$\sqrt{2\pi} \left[e^{- \omega } - \frac{1}{2} \right] \operatorname{sgn}(\omega)$
9. $e^{-ax} \quad [a > 0]$	$\sqrt{\frac{2}{\pi}} \frac{\omega}{a^2 + \omega^2}$
10. $xe^{-ax} \quad [a > 0]$	$\sqrt{\frac{2}{\pi}} \frac{2a\omega}{(a^2 + \omega^2)^2}$
11. $xe^{-x^2/2}$	$\omega e^{-\omega^2/2}$
12. $\frac{e^{-ax}}{x} \quad [a > 0]$	$\frac{2}{\pi} \arctan(\omega/a)$
13. $x^{n-1} e^{-ax} \quad [a > 0, n > 0]$	$\sqrt{\frac{2}{\pi}} \frac{\Gamma(n) \sin[n \arctan(\omega/a)]}{(a^2 + \omega^2)^{n/2}}$
14. $\frac{e^{-bx} - e^{-ax}}{x} \quad [a > b]$	$\sqrt{\frac{2}{\pi}} \arctan \left[\frac{(a-b)\omega}{ab + \omega^2} \right]$

(Continues)

Table 20.3. (Continued)

	$f(x) = \sqrt{\frac{2}{\pi}} \int_0^\infty F_s(\omega) \sin \omega x \, d\omega$	$F_s(\omega) = \sqrt{\frac{2}{\pi}} \int_0^\infty f(x) \sin \omega x \, dx$
15.	$\operatorname{csch} x$	$\sqrt{\frac{\pi}{2}} \tanh(\pi\omega/2)$
16.	$x \operatorname{csch} x$	$\sqrt{2\pi^3} \frac{e^{\pi\omega}}{(1 + e^{\pi\omega})^2}$
17.	$\frac{\sin(ax)}{x} \quad [a > 0]$	$\frac{1}{\sqrt{2\pi}} \ln \left(\frac{\omega + a}{\omega - a} \right)$
18.	$\frac{\sin(ax)}{x^2} \quad [a > 0]$	$\begin{cases} \sqrt{\frac{\pi}{2}} \omega, & \omega < a \\ \sqrt{\frac{\pi}{2}} a, & \omega > a \end{cases}$
19.	$\frac{\sinh(ax)}{\cosh(bx)} \quad [0 < a < b]$	$\frac{\sqrt{2\pi}}{b} \frac{\sin(\pi a/2b) \sinh(\pi\omega/b)}{\cos(\pi a/b) + \cosh(\pi\omega/b)}$
20.	$\frac{\cosh(ax)}{\sinh(bx)} \quad [0 < a < b]$	$\frac{1}{b} \sqrt{\frac{\pi}{2}} \frac{\sinh(\pi\omega/b)}{\cosh(\pi\omega/b) + \cos(\pi a/b)}$
21.	$\frac{x J_0(ax)}{(b^2 + x^2)} \quad [a, b > 0]$	$\sqrt{\frac{\pi}{2}} e^{-b\omega} I_0(a\omega) \quad [\omega > a]$

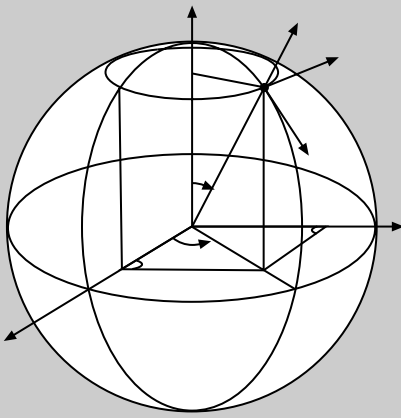

Chapter 21

Numerical Integration

21.1 CLASSICAL METHODS

21.1.1 Open- and Closed-Type Formulas

The numerical integration (quadrature) formulas that follow are of the form

$$1. \quad I = \int_a^b f(x) dx = \sum_{k=0}^n w_k^{(n)} f(x_k) + R_n,$$

with $a \leq x_0 < x_1 < \dots < x_n \leq b$. The weight coefficients $w_k^{(n)}$ and the abscissas x_k , with $k = 0, 1, \dots, n$ are known numbers independent of $f(x)$ that are determined by the numerical integration method to be used and the number of points at which $f(x)$ is to be evaluated. The **remainder term**, R_n , when added to the summation, makes the result exact. Although, in general, the precise value of R_n is unknown, its analytical form is usually known and can be used to determine an upper bound to $|R_n|$ in terms of n .

An integration formula is said to be of the **closed type** if it requires the function values to be determined at the end points of the interval of integration, so that $x_0 = a$ and $x_n = b$. An integration formula is said to be of **open type** if $x_0 > a$ and $x_n < b$, so that in this case the function values are not required at the end points of the interval of integration.

Many fundamental numerical integration formulas are based on the assumption that an interval of integration contains a specified number of abscissas at which points the function must be evaluated. Thus, in the basic Simpson's rule, the interval $a \leq x \leq b$ is divided into two subintervals of equal length at the ends of which the function has to be evaluated, so that $f(x_0)$, $f(x_1)$, and $f(x_2)$ are required, with $x_0 = a$, $x_1 = \frac{1}{2}(a + b)$, and $x_2 = b$. To control the

error, the interval $a \leq x \leq b$ is normally subdivided into a number of smaller intervals, to each of which the basic integration formula is then applied and the results summed to yield the numerical estimate of the integral. When this approach is organized so that it yields a single integration formula, it is usual to refer to the result as a **composite** integration formula.

21.1.2 Composite Midpoint Rule (open type)

$$1. \int_a^b f(x) dx = 2h \sum_{k=0}^{n/2} f(x_{2k}) + R_n,$$

with n an even integer, $1 + (n/2)$ subintervals of length $h = (b - a)/(n + 2)$, $x_k = a + (k + 1)h$ for $k = -1, 0, 1, \dots, n + 1$, and the remainder term

$$2. R_n = \frac{(b - a)h^2}{6} f^{(2)}(\xi) = \frac{(n + 2)h^3}{6} f^{(2)}(\xi),$$

for some ξ such that $a < \xi < b$.

21.1.3 Composite Trapezoidal Rule (closed type)

$$1. \int_a^b f(x) dx = \frac{h}{2} \left[f(a) + f(b) + 2 \sum_{k=1}^{n-1} f(x_k) \right] + R_n,$$

with n an integer (even or odd), $h = (b - a)/n$, $x_k = a + kh$ for $k = 0, 1, 2, \dots, n$, and the remainder term

$$2. R_n = -\frac{(b - a)h^2}{12} f^{(2)}(\xi) = -\frac{nh^3}{12} f^{(2)}(\xi),$$

for some ξ such that $a < \xi < b$.

21.1.4 Composite Simpson's Rule (closed type)

$$1. \int_a^b f(x) dx = \frac{h}{3} \left[f(a) + f(b) + 2 \sum_{k=1}^{(n/2)-1} f(x_{2k}) + 4 \sum_{k=1}^{n/2} f(x_{2k-1}) \right] + R_n,$$

with n an even integer, $h = (b - a)/n$, $x_k = a + kh$ for $k = 0, 1, 2, \dots, n$, and the remainder term

$$2. R_n = -\frac{(b - a)h^4}{180} f^{(4)}(\xi) = -\frac{nh^5}{180} f^{(4)}(\xi),$$

for some ξ such that $a < \xi < b$.

21.1.5 Newton–Cotes formulas

Closed types

$$1. \int_{x_0}^{x_3} f(x) dx = \frac{3h}{8}(f(x_0) + 3f(x_1) + 3f(x_2) + f(x_3)) + R,$$

$h = (x_3 - x_0)/3$, $x_k = x_0 + kh$ for $k = 0, 1, 2, 3$, and the remainder term

$$2. R = -\frac{3h^5}{80}f^{(4)}(\xi),$$

for some ξ such that $x_0 < \xi < x_3$.

(Simpson's $\frac{3}{8}$ rule)

$$3. \int_{x_0}^{x_4} f(x) dx = \frac{2h}{45}(7f(x_0) + 32f(x_1) + 12f(x_2) + 32f(x_3) + 7f(x_4)) + R,$$

$h = (x_4 - x_0)/4$, $x_k = x_0 + kh$ for $k = 0, 1, 2, 3, 4$, and the remainder term

$$4. R = -\frac{8h^7}{945}f^{(6)}(\xi),$$

for some ξ such that $x_0 < \xi < x_4$.

(Bode's rule)

$$5. \int_{x_0}^{x_5} f(x) dx = \frac{5h}{288}(19f(x_0) + 75f(x_1) + 50f(x_2) + 50f(x_3) + 75f(x_4) + 19f(x_5)) + R,$$

$h = (x_5 - x_0)/5$, $x_k = x_0 + kh$ for $k = 0, 1, 2, 3, 4, 5$, and the remainder term

$$6. R = -\frac{275h^7}{12096}f^{(6)}(\xi),$$

for some ξ such that $x_0 < \xi < x_5$.

Open types

$$7. \int_{x_0}^{x_3} f(x) dx = \frac{3h}{2}(f(x_1) + f(x_2)) + R,$$

$h = (x_3 - x_0)/3$, $x_k = x_0 + kh$, $k = 1, 2$, and the remainder term

$$8. R = \frac{h^3}{4}f^{(2)}(\xi),$$

for some ξ such that $x_0 < \xi < x_3$.

$$9. \int_{x_0}^{x_4} f(x) dx = \frac{4h}{3}(2f(x_1) - f(x_2) + 2f(x_3)) + R,$$

$h = (x_4 - x_0)/4$, $x_k = x_0 + kh$ for $k = 1, 2, 3$, and the remainder term

$$10. R = \frac{28h^5}{90} f^{(4)}(\xi),$$

for some ξ such that $x_0 < \xi < x_4$.

$$11. \int_{x_0}^{x_5} f(x) dx = \frac{5h}{24} (11f(x_1) + f(x_2) + f(x_3) + 11f(x_4)) + R,$$

$h = (x_5 - x_0)/5$, $x_k = x_0 + kh$ for $k = 1, 2, 3, 4$, and the remainder term

$$12. R = \frac{95h^5}{144} f^{(4)}(\xi),$$

for some ξ such that $x_0 < \xi < x_5$.

21.1.6 Gaussian Quadrature (open-type)

The fundamental Gaussian quadrature formula applies to an integral over the interval $[-1, 1]$. It is a highly accurate method, but unlike the other integration formulas given here it involves the use of abscissas that are unevenly spaced throughout the interval of integration.

$$1. \int_{-1}^1 f(x) dx = \sum_{k=1}^n w_k^{(n)} f(x_k^{(n)}) + R_n,$$

where the abscissa $x_k^{(n)}$ is the k 'th zero of the Legendre polynomial $P_n(x)$, and the weight $w_k^{(n)}$ is given by

$$2. w_k^{(n)} = 2 \left[P_n'(x_k^{(n)}) \right]^2 / \left(1 - (x_k^{(n)})^2 \right).$$

The remainder term is

$$3. R_n = \frac{2^{2n+1}(n!)^4}{(2n+1)[(2n)!]^3} f^{(2n)}(\xi),$$

for some ξ such that $-1 < \xi < 1$.

To apply this result to an integral over the interval $[a, b]$ the substitution

$$4. y_k^{(n)} = \frac{1}{2}(b-a)x_k^{(n)} + \frac{1}{2}(b+a)$$

is made, yielding the result

$$5. \int_a^b f(y) dy = \frac{1}{2}(b-a) \sum_{k=1}^n w_k^{(n)} f[y_k^{(n)}] + R_n,$$

where the remainder term is now

$$R_n = \frac{(b-a)^{2n+1} (n!)^4}{(2n+1) [(2n)!]^3} f^{(2n)}(\xi),$$

for some $a < \xi < b$.

The abscissas and weights for $n = 2, 3, 4, 5, 6$ are given in Table 21.1.

21.1.7 Romberg Integration (closed-type)

A robust and efficient method for the evaluation of the integral

$$1. \quad I = \int_a^b f(x) dx$$

is provided by the process of **Romberg integration**. The method proceeds in stages, with an increase in accuracy of the numerical estimate of I occurring at the end of each successive

Table 21.1. Gaussian Abscissas and Weights

n	k	$x_k^{(n)}$	$w_k^{(n)}$
2	1	0.5773502692	1.0000000000
	2	-0.5773502692	1.0000000000
3	1	0.7745966692	0.5555555555
	2	0.0000000000	0.8888888888
	3	-0.7745966692	0.5555555555
4	1	0.8611363116	0.3478548451
	2	0.3399810436	0.6521451549
	3	-0.3399810436	0.6521451549
	4	-0.8611363116	0.3478548451
5	1	0.9061798459	0.2369268850
	2	0.5384693101	0.4786286205
	3	0.0000000000	0.5688888889
	4	-0.5384693101	0.4786286205
	5	-0.9061798459	0.2369268850
6	1	0.9324695142	0.1713244924
	2	0.6612093865	0.3607615730
	3	0.2386191861	0.4679139346
	4	0.2386191861	0.4679139346
	5	-0.6612093865	0.3607615730
	6	-0.9324695142	0.1713244924

stage. The process may be continued until the result is accurate to the required number of decimal places, provided that at the n th stage the derivative $f^{(n)}(x)$ is nowhere singular in the interval of integration.

Romberg integration is based on the composite trapezoidal rule and an extrapolation process (Richardson extrapolation), and is well suited to implementation on a computer. This is because of the efficient use it makes of the function evaluations that are necessary at each successive stage of the computation, and its speed of convergence, which enables the numerical estimate of the integral to be obtained to the required degree of precision relatively quickly.

The Romberg Method At the m th stage of the calculation, the interval of integration $a \leq x \leq b$ is divided into 2^m intervals of length $(b - a)/2^m$. The corresponding composite trapezoidal estimate for I is then given by

$$1. \quad I_{0,0} = \frac{(b - a)}{2} [f(a) + f(b)] \quad \text{and} \quad I_{0,m} = \frac{(b - a)}{2^m} \left[\frac{1}{2} f(a) + \frac{1}{2} f(b) + \sum_{r=1}^{2^m - 1} f(x_r) \right],$$

where $x_r = a + r[(b - a)/2^m]$ for $r = 1, 2, \dots, 2^m - 1$. Here the initial suffix represents the computational step reached at the m 'th stage of the calculation, with the value zero indicating the initial trapezoidal estimate. The second suffix starts with the number of subintervals on which the initial trapezoidal estimate is based and the steps down to zero at the end of the m th stage.

Define

$$2. \quad I_{k,m} = \frac{4^k I_{k-1,m+1} - I_{k-1,m}}{4^k - 1},$$

for $k = 1, 2, \dots$ and $m = 1, 2, \dots$.

For some preassigned error $\varepsilon > 0$ and some integer N , $I_{N,0}$ is the required estimate of the integral to within an error ε if

$$3. \quad |I_{N,0} - I_{N-1,1}| < \varepsilon.$$

The pattern of the calculation proceeds as shown here. Each successive entry in the r 'th row provides an increasingly accurate estimate of the integral, with the final estimate at the end of the r 'th stage of the calculation being provided by $I_{r,0}$:

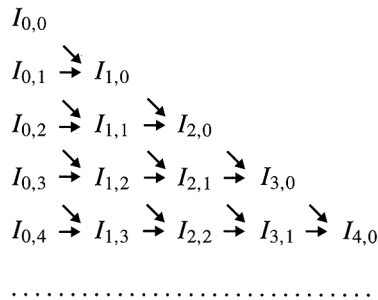

To illustrate the method consider the integral

$$I = \int_1^5 \frac{\ln(1 + \sqrt{x})}{1 + x^2} dx.$$

Four stages of Romberg integration lead to the following results, inspection of which shows that the approximation $I_{4,0} = 0.519256$ has converged to five decimal places. Notice that the accuracy achieved in $I_{4,0}$ was obtained as a result of only 17 function evaluations at the end of the 16 subintervals involved, coupled with the use of relation 21.1.7.2. To obtain comparable accuracy using only the trapezoidal rule would involve the use of 512 subintervals.

$I_{0,m}$	$I_{1,m}$	$I_{2,m}$	$I_{3,m}$	$I_{4,m}$
0.783483				
0.592752	0.529175			
0.537275	0.518783	0.518090		
0.523633	0.519086	0.519106	0.519122	
0.520341	0.519243	0.519254	0.519255	0.519256

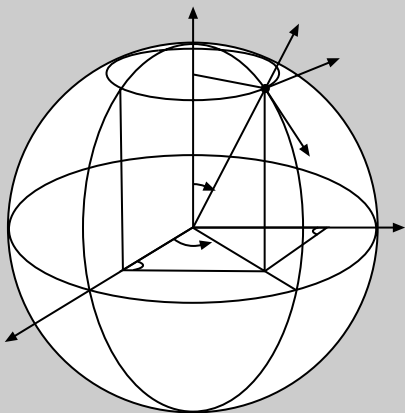

Chapter 22

Solutions of Standard Ordinary Differential Equations

22.1 INTRODUCTION

22.1.1 Basic Definitions

22.1.1.1

An n th-order ordinary differential equation (ODE) for the function $y(x)$ is an equation defined on some interval I that relates $y^{(n)}(x)$ and some or all of $y^{(n-1)}(x)$, $y^{(n-2)}(x), \dots, y^{(1)}(x), y(x)$ and x , where $y^{(r)}(x) = d^r y/dx^r$. In its most general form, such an equation can be written

1. $F(x, y(x), y^{(1)}(x), \dots, y^{(n)}(x)) = 0$,

where $y^{(n)}(x) \neq 0$ and F is an arbitrary function of its arguments.

The **general solution** of 22.1.1.1 is an n times differentiable function $Y(x)$, defined on I , that contains n arbitrary constants, with the property that when $y = Y(x)$ is substituted into the differential equation reduces it to an identity in x . A **particular solution** is a special case of the general solution in which the arbitrary constants have been assigned specific numerical values.

22.1.2 Linear Dependence and Independence

22.1.2.1

A set of functions $y_1(x), y_2(x), \dots, y_n(x)$ defined on some interval I is said to be **linearly dependent** on the interval I if there are constants c_1, c_2, \dots, c_n , not all zero, such that

$$1. \quad c_1 y_1(x) + c_2 y_2(x) + \cdots + c_n y_n(x) = 0.$$

The set of functions is said to be **linearly independent** on I if 22.1.2.1.1 implies that $c_1 = c_2 = \cdots = c_n = 0$ for all x in I .

The following **Wronskian test** provides a test for linear dependence.

Wronskian test. Let the n functions $y_1(x), y_2(x), \dots, y_n(x)$ defined on an interval I be continuous together with their derivatives of every order up to and including those of order n . Then the functions are linearly dependent on I if the **Wronskian determinant** $W[y_1, y_2, \dots, y_n] = 0$ for all x in I , where

$$2. \quad W[y_1, y_2, \dots, y_n] = \begin{vmatrix} y_1 & y_2 & \cdots & y_n \\ y_1^{(1)} & y_2^{(1)} & \cdots & y_n^{(1)} \\ \vdots & \vdots & \vdots & \vdots \\ y_1^{(n-1)} & y_2^{(n-1)} & \cdots & y_n^{(n-1)} \end{vmatrix}$$

Example 22.1 The functions $1, \sin^2 x$, and $\cos^2 x$ are linearly dependent for all x , because setting $y_1 = 1, y_2 = \sin^2 x, y_3 = \cos^2 x$ gives us the following Wronskian:

$$W[y_1, y_2, y_3] = \begin{vmatrix} 1 & \sin^2 x & \cos^2 x \\ 0 & 2 \sin x \cos x & -2 \sin x \cos x \\ 0 & 2(\cos^2 x - \sin^2 x) & -2(\cos^2 x - \sin^2 x) \end{vmatrix} = 0.$$

The linear dependence of these functions is obvious from the fact that

$$1 = \sin^2 x + \cos^2 x,$$

because when this is written in the form

$$y_1 - y_2 - y_3 = 0$$

and compared with 22.1.2.1.1 we see that $c_1 = 1, c_2 = -1$, and $c_3 = -1$.

Example 22.2 The functions $1, \sin x$, and $\cos x$ are linearly independent for all x , because setting $y_1 = 1, y_2 = \sin x, y_3 = \cos x$, gives us the following Wronskian:

$$W[y_1, y_2, y_3] = \begin{vmatrix} 1 & \sin x & \cos x \\ 0 & \cos x & -\sin x \\ 0 & -\sin x & -\cos x \end{vmatrix} = -1.$$

Example 22.3 Let us compute the Wronskian of the functions

$$y_1 = \begin{cases} x, & x < 0 \\ 0, & x \geq 0 \end{cases} \quad \text{and} \quad y_2 = \begin{cases} 0, & x < 0 \\ x, & x \geq 0 \end{cases}$$

which are defined for all x . For $x < 0$ we have

$$W[y_1, y_2] = \begin{vmatrix} x & 0 \\ 1 & 0 \end{vmatrix} = 0,$$

whereas for $x \geq 0$

$$W[y_1, y_2] = \begin{vmatrix} 0 & x \\ 0 & 1 \end{vmatrix} = 0,$$

so for all x

$$W[y_1, y_2] = 0.$$

However, despite the vanishing of the Wronskian for all x , the functions y_1 and y_2 are *not* linearly dependent, as can be seen from 22.1.2.1.1, because there exist no nonzero constants c_1 and c_2 such that

$$c_1 y_1 + c_2 y_2 = 0$$

for all x . This is not a failure of the Wronskian test, because although y_1 and y_2 are continuous, their first derivatives are not continuous as required by the Wronskian test.

22.2 SEPARATION OF VARIABLES

22.2.1

A differential equation is said to have **separable variables** if it can be written in the form

$$1. \quad F(x)G(y) dx + f(x)g(y) dy = 0.$$

The general solution obtained by direct integration is

$$2. \quad \int \frac{F(x)}{f(x)} dx + \int \frac{g(y)}{G(y)} dy = \text{const.}$$

22.3 LINEAR FIRST-ORDER EQUATIONS

22.3.1

The **general linear first-order equation** is of the form

$$1. \quad \frac{dy}{dx} + P(x)y = Q(x).$$

This equation has an **integrating factor**

$$2. \quad \mu(x) = e^{\int P(x) dx},$$

and in terms of $\mu(x)$ the general solution becomes

$$3. \quad y(x) = \frac{c}{\mu(x)} + \frac{1}{\mu(x)} \int Q(x) \mu(x) dx,$$

where c is an arbitrary constant. The first term on the right-hand side is the complementary function $y_c(x)$, and the second term is the particular integral of $y_p(x)$ (see 22.7.1).

Example 22.4 Find the general solution of

$$\frac{dy}{dx} + \frac{2}{x}y = \frac{1}{x^2(1+x^2)}.$$

In this case $P(x) = 2/x$ and $Q(x) = x^{-2}(1+x^2)^{-1}$, so

$$\mu(x) = \exp\left[\int \frac{2}{x} dx\right] = x^2$$

and

$$y(x) = \frac{c}{x^2} + \frac{1}{x^2} \int \frac{dx}{1+x^2}$$

so that

$$y(x) = \frac{c}{x^2} + \frac{1}{x^2} \arctan x.$$

Notice that the arbitrary additive integration constant involved in the determination of $\mu(x)$ has been set equal to zero. This is justified by the fact that, had this not been done, the constant factor so introduced could have been incorporated into the arbitrary constant c .

22.4 BERNOULLI'S EQUATION

22.4.1

Bernoulli's equation is a *nonlinear* first-order equation of the form

$$1. \quad \frac{dy}{dx} + p(x)y = q(x)y^\alpha,$$

with $\alpha \neq 0$ and $\alpha \neq 1$.

Division of 22.4.1.1 by y^α followed by the change of variable

$$2. \quad z = y^{1-\alpha}$$

converts Bernoulli's equation to the linear first-order equation

$$3. \quad \frac{dz}{dx} + (1 - \alpha) p(x)z = (1 - \alpha)q(x)$$

which may be solved for $z(x)$ by the method of 22.3.1. The solution of the original equation is given by

$$4. \quad y(x) = z^{1/(1-\alpha)}.$$

22.5 EXACT EQUATIONS

22.5.1

An **exact equation** is of the form

$$1. \quad P(x, y) dx + Q(x, y) dy = 0,$$

where $P(x, y)$ and $Q(x, y)$ satisfy the condition

$$2. \quad \frac{\partial P}{\partial y} = \frac{\partial Q}{\partial x}.$$

Thus the left-hand side of 22.5.1.1 is the total differential of some function $F(x, y) = \text{constant}$, with $P(x, y) = \partial F/\partial x$ and $Q(x, y) = \partial F/\partial y$.

The general solution is

$$3. \quad \int P(x, y) dx + \int \left[Q(x, y) - \frac{\partial}{\partial y} \int P(x, y) dx \right] dy = \text{const.},$$

where integration with respect to x implies y is to be regarded as a constant, while integration with respect to y implies x is to be regarded as a constant.

Example 22.5 Find the general solution of

$$3x^2y dx + (x^3 - y^2) dy = 0.$$

Setting $P(x, y) = 3x^2y$ and $Q(x, y) = x^3 - y^2$ we see the equation is exact because $\partial P/\partial y = \partial Q/\partial x = 3x^2$. It follows that

$$\int P(x, y) dx = \int 3x^2y dx = 3y \int x^2 dx = x^3y + c_1,$$

where c_1 is an arbitrary constant, whereas

$$\int \left[Q(x, y) - \frac{\partial}{\partial y} \int P(x, y) dx \right] dy = \int [x^3 - y^2 - x^3] dy = -\frac{1}{3}y^3 + c_2,$$

where c_2 is an arbitrary constant. Thus, the required solution is

$$x^3y - \frac{1}{3}y^3 = c,$$

where $c = -(c_1 + c_2)$ is an arbitrary constant.

22.6 HOMOGENEOUS EQUATIONS

22.6.1

In its simplest form, a **homogeneous equation** may be written

1. $\frac{dy}{dx} = F\left(\frac{y}{x}\right),$

where F is a function of the single variable

2. $u = y/x.$

More generally, a homogeneous equation is of the form

3. $P(x, y) dx + Q(x, y) dy = 0,$

where P and Q are both algebraically homogeneous functions of the same degree. Here, by requiring P and Q to be **algebraically homogeneous of degree n** , we mean that

4. $P(kx, ky) = k^n P(x, y) \quad \text{and} \quad Q(kx, ky) = k^n Q(x, y),$

with k a constant.

The solution of 22.6.1.1 is given in implicit form by

5. $\ln x = \int \frac{du}{F(u) - u}.$

The solution of 22.6.1.3 also follows from this same result by setting $F = -P/Q$.

22.7 LINEAR DIFFERENTIAL EQUATIONS

22.7.1

An **n th-order variable coefficient differential equation** is *linear* if it can be written in the form

1. $\tilde{a}_0(x)y^{(n)} + \tilde{a}_1(x)y^{(n-1)} + \cdots + \tilde{a}_n(x)y = \tilde{f}(x),$

where $\tilde{a}_0, \tilde{a}_1, \dots, \tilde{a}_n$ and \tilde{f} are real-valued functions defined on some interval I . Provided $\tilde{a}_0 \neq 0$ this equation can be rewritten as

$$2. \quad y^{(n)} + a_1(x)y^{(n-1)} + \cdots + a_n(x)y = f(x),$$

where $a_r = \tilde{a}_r/\tilde{a}_0$, $r = 1, 2, \dots, n$, and $f = \tilde{f}/\tilde{a}_0$.

It is convenient to write 22.7.1.2 in the form

$$3. \quad L[y(x)] = f(x),$$

where

$$4. \quad L[y(x)] = y^{(n)} + a_1(x)y^{(n-1)} + \cdots + a_n(x)y.$$

The n th-order linear differential equation 22.7.1.2 is called **inhomogeneous (non-homogeneous)** when $f(x) \not\equiv 0$, and **homogeneous** when $f(x) \equiv 0$.

The homogeneous equation corresponding to 22.7.1.2 is

$$5. \quad L[y(x)] = 0.$$

This equation has n linearly independent solutions $y_1(x), y_2(x), \dots, y_n(x)$ and its general solution, also called the **complementary function**, is

$$6. \quad y_c(x) = c_1 y_1(x) + c_2 y_2(x) + \cdots + c_n y_n(x),$$

where c_1, c_2, \dots, c_n are arbitrary constants.

The **general solution** of the inhomogeneous equation 22.7.1.2 is

$$7. \quad y(x) = y_c(x) + y_p(x),$$

where the form of the **particular integral** $y_p(x)$ is determined by the inhomogeneous term $f(x)$ and contains no arbitrary constants.

An **initial value problem** for 22.7.1.3 involves the determination of a solution satisfying the **initial conditions** at $x = x_0$,

$$8. \quad y(x_0) = y_0, \quad y^{(1)}(x_0) = y_1, \dots, y^{(n-1)}(x_0) = y_{n-1}$$

for some specified values of y_0, y_1, \dots, y_{n-1} .

A **two-point boundary value problem** for a differential equation involves the determination of a solution satisfying suitable values of y and certain of its derivatives at the two distinct points $x = a$ and $x = b$.

22.8 CONSTANT COEFFICIENT LINEAR DIFFERENTIAL EQUATIONS—HOMOGENEOUS CASE

22.8.1

A special case of 22.7.1.3 arises when the coefficients a_1, a_2, \dots, a_n are real-valued absolute constants. Such equations are called **linear constant coefficient differential equations**.

The determination of the n linearly independent solutions y_1, y_2, \dots, y_n that enter into the general solution

1. $y_c = c_1 y_1(x) + c_2 y_2(x) + \dots + c_n y_n(x)$
of the associated constant coefficient homogeneous equation $L[y(x)] = 0$ may be obtained as follows:

- (i) Form the n 'th degree **characteristic polynomial** $P_n(\lambda)$ defined as
- (ii) $P_n(\lambda) = \lambda^n + a_1 \lambda^{n-1} + \dots + a_n$,
where a_1, a_2, \dots, a_n are the constant coefficients occurring in $L[y(x)] = 0$.
- (iii) Factor $P_n(\lambda)$ into a product of the form

$$P_n(\lambda) = (\lambda - \lambda_1)^p (\lambda - \lambda_2)^q \dots (\lambda - \lambda_m)^r,$$

where

$$p + q + \dots + r = n,$$

and $\lambda_1, \lambda_2, \dots, \lambda_m$ are either real roots of $P_n(\lambda) = 0$ or, if they are complex, they occur in complex conjugate pairs [because the coefficients of $P_n(\lambda)$ are all real]. Roots $\lambda_1, \lambda_2, \dots, \lambda_m$ are said to have **multiplicities** p, q, \dots, r , respectively.

- (iv) To every real root $\lambda = \mu$ of $P_n(\lambda) = 0$ with multiplicity M there corresponds the M linearly independent solutions of $L[y(x)] = 0$:

$$y_1(x) = e^{\mu x}, \quad y_2(x) = x e^{\mu x}, \quad y_3(x) = x^2 e^{\mu x}, \dots, \quad y_M(x) = x^{M-1} e^{\mu x}.$$

- (v) To every pair of complex conjugate roots of $P_n(\lambda) = 0$, $\lambda = \alpha + i\beta$, and $\lambda = \alpha - i\beta$, each with multiplicity N , there corresponds the $2N$ linearly independent solutions of $L[y(x)] = 0$

$$\begin{array}{ll} y_1(x) = e^{\alpha x} \cos \beta x & \bar{y}_1(x) = e^{\alpha x} \sin \beta x \\ y_2(x) = x e^{\alpha x} \cos \beta x & \bar{y}_2(x) = x e^{\alpha x} \sin \beta x \\ \vdots & \vdots \\ y_N(x) = x^{N-1} e^{\alpha x} \cos \beta x & \bar{y}_N(x) = x^{N-1} e^{\alpha x} \sin \beta x \end{array}$$

- (vi) The general solution of the homogeneous equation $L[y(x)] = 0$ is then the sum of each of the linearly independent solutions found in (v) and (vi) multiplied by a real arbitrary constant. If a solution of an initial value problem is required for the homogeneous equation $L[y(x)] = 0$, the arbitrary constants in $y_c(x)$ must be chosen so that $y_c(x)$ satisfies the initial conditions.

Example 22.6 Find the general solution of the homogeneous equation

$$y^{(3)} - 2y^{(2)} - 5y^{(1)} + 6y = 0,$$

and the solution of the initial value problem in which $y(0) = 1$, $y^{(1)}(0) = 0$, and $y^{(2)}(0) = 2$. The characteristic polynomial

$$\begin{aligned} P_3(\lambda) &= \lambda^3 - 2\lambda^2 - 5\lambda + 6 \\ &= (\lambda - 1)(\lambda + 2)(\lambda - 3), \end{aligned}$$

so the roots of $P_3(\lambda) = 0$ are $\lambda_1 = 1$, $\lambda_2 = -2$, and $\lambda_3 = 3$, which are all real with multiplicity 1. Thus, the general solution is

$$y(x) = c_1e^x + c_2e^{-2x} + c_3e^{3x}.$$

To solve the initial value problem the constants c_1 , c_2 , and c_3 must be chosen such that when $x = 0$, $y = 1$, $dy/dx = 0$, and $d^2y/dx^2 = 2$.

$$\begin{aligned} y(0) = 1 &\quad \text{implies} \quad 1 = c_1 + c_2 + c_3 \\ y^{(1)}(0) = 0 &\quad \text{implies} \quad 0 = c_1 - 2c_2 + 3c_3 \\ y^{(2)}(0) = 2 &\quad \text{implies} \quad 2 = c_1 + 4c_2 + 9c_3 \end{aligned}$$

so $c_1 = 2/3$, $c_2 = 1/3$, and $c_3 = 0$ leading to the solution

$$y(x) = \frac{2}{3}e^x + \frac{1}{3}e^{-2x}.$$

Example 22.7 Find the general solution of the homogeneous equation

$$y^{(4)} + 5y^{(3)} + 8y^{(2)} + 4y^{(1)} = 0.$$

The characteristic polynomial

$$\begin{aligned} P_4(\lambda) &= \lambda^4 + 5\lambda^3 + 8\lambda^2 + 4\lambda \\ &= \lambda(\lambda + 1)(\lambda + 2)^2, \end{aligned}$$

so the roots of $P_4(\lambda) = 0$ are $\lambda_1 = 0$, $\lambda_2 = -1$, and $\lambda_3 = -2$ (twice), which are all real, but λ_3 has multiplicity 2. Thus, the general solution is

$$y(x) = c_1 + c_2e^{-x} + c_3e^{-2x} + c_4xe^{-2x}.$$

Example 22.8 Find the general solution of the homogeneous equation

$$y^{(3)} + 3y^{(2)} + 9y^{(1)} - 13y = 0.$$

The characteristic polynomial

$$\begin{aligned} P_3(\lambda) &= \lambda^3 + 3\lambda^2 + 9\lambda - 13 \\ &= (\lambda - 1)(\lambda^2 + 4\lambda + 13), \end{aligned}$$

so the roots of $P_3(\lambda) = 0$ are $\lambda_1 = 1$ and the pair of complex conjugate roots of the real quadratic factor, which are $\lambda_2 = -2 - 3i$ and $\lambda_3 = -2 + 3i$. All the roots have multiplicity 1. Thus, the general solution is

$$y(x) = c_1 e^x + c_2 e^{-2x} \cos 3x + c_3 e^{-2x} \sin 3x.$$

Example 22.9 Find the general solution of the homogeneous equation

$$y^{(5)} - 4y^{(4)} + 14y^{(3)} - 20y^{(2)} + 25y^{(1)} = 0.$$

The characteristic polynomial

$$\begin{aligned} P_5(\lambda) &= \lambda^5 - 4\lambda^4 + 14\lambda^3 - 20\lambda^2 + 25\lambda \\ &= \lambda(\lambda^2 - 2\lambda + 5)^2, \end{aligned}$$

so the roots of $P_5(\lambda) = 0$ are the single real root $\lambda_1 = 0$ and the complex conjugate roots of the real quadratic factor $\lambda_2 = 1 - 2i$ and $\lambda_3 = 1 + 2i$, each with multiplicity 2. Thus, the general solution is

$$y(x) = c_1 + c_2 e^x \cos 2x + c_3 x e^x \cos 2x + c_4 e^x \sin 2x + c_5 x e^x \sin 2x.$$

Example 22.10 Use the Laplace transform to solve the initial value problem in Example 22.6.

Taking the Laplace transform of the differential equation

$$\frac{d^3 y}{dx^3} - 2 \frac{d^2 y}{dx^2} - 5 \frac{dy}{dx} + 6y = 0$$

gives, after using 19.1.21.2,

$$\begin{aligned} & \underbrace{s^3 Y(s) - y^{(2)}(0) - s y^{(1)}(0) - s^2 y(0)}_{\mathcal{L}[d^3 y/dx^3]} - \underbrace{2(s^2 Y(s) - y^{(1)}(0) - s y(0))}_{2\mathcal{L}[d^2 y/dx^2]} \\ & - \underbrace{5(sY(s) - y(0))}_{5\mathcal{L}[dy/dx]} + \underbrace{6Y(s)}_{6\mathcal{L}[y]} = 0. \end{aligned}$$

After substituting the initial values $y(0) = 1$, $y^{(1)}(0) = 0$, and $y^{(2)}(0) = 2$ this reduces to

$$(s^3 - 2s^2 - 5s + 6)Y(s) = s^2 - 2s - 3,$$

so

$$Y(s) = \frac{s^2 - 2s - 3}{s^3 - 2s^2 - 5s + 6} = \frac{s + 1}{(s - 1)(s + 2)}.$$

When expressed in terms of partial fractions (see 1.7.2) this becomes

$$Y(s) = \frac{2}{3} \frac{1}{s - 1} + \frac{1}{3} \frac{1}{s + 2}.$$

Inverting this result by means of entry 5 in Table 19.1 leads to

$$y(x) = \frac{2}{3}e^x + \frac{1}{3}e^{-2x},$$

which is, of course, the solution obtained in Example 22.6.

22.9 LINEAR HOMOGENEOUS SECOND-ORDER EQUATION

22.9.1

An important elementary equation that arises in many applications is the linear homogeneous second-order equation

$$1. \quad \frac{d^2y}{dx^2} + a \frac{dy}{dx} + by = 0,$$

where a , b are real-valued constants.

The characteristic polynomial is

$$2. \quad P_2(\lambda) = \lambda^2 + a\lambda + b,$$

and the nature of the roots of $P_2(\lambda) = 0$ depends on the **discriminant** $a^2 - 4b$, which may be positive, zero, or negative.

Case 1. If $a^2 - 4b > 0$, the characteristic equation $P_2(\lambda) = 0$ has the two distinct real roots

$$3. \quad m_1 = \frac{1}{2}[-a - \sqrt{a^2 - 4b}] \quad \text{and} \quad m_2 = \frac{1}{2}[-a + \sqrt{a^2 - 4b}],$$

and the solution is

$$4. \quad y(x) = c_1 e^{m_1 x} + c_2 e^{m_2 x}.$$

This solution decays to zero as $x \rightarrow +\infty$ if $m_1, m_2 < 0$, and becomes infinite if a root is positive.

Case 2. If $a^2 - 4b = 0$, the characteristic equation $P_2(\lambda) = 0$ has the two identical real roots (multiplicity 2)

$$5. \quad m_1 = \frac{1}{2}a,$$

and the solution is

$$6. \quad y(x) = c_1 e^{m_1 x} + c_2 x e^{m_1 x}.$$

This solution is similar to that of Case 1 in that it decays to zero as $x \rightarrow +\infty$ if $m_1 < 0$ and becomes infinite if $m_1 > 0$.

Case 3. If $a^2 - 4b < 0$, the characteristic equation $P_2(\lambda) = 0$ has the complex conjugate roots

$$7. \quad m_1 = \alpha + i\beta \quad \text{and} \quad m_2 = \alpha - i\beta,$$

where

$$8. \quad \alpha = -\frac{1}{2}a \quad \text{and} \quad \beta = \frac{1}{2}\sqrt{4b - a^2},$$

and the solution is

$$9. \quad y(x) = e^{\alpha x} (c_1 \cos \beta x + c_2 \sin \beta x).$$

This solution is oscillatory and decays to zero as $x \rightarrow +\infty$ if $\alpha < 0$, and becomes infinite if $\alpha > 0$.

22.10 LINEAR DIFFERENTIAL EQUATIONS—INHOMOGENEOUS CASE AND THE GREEN'S FUNCTION

22.10.1

The general solution of the inhomogeneous constant coefficient n 'th-order linear differential equation

$$1. \quad y^{(n)} + a_1 y^{(n-1)} + a_2 y^{(n-2)} + \cdots + a_n y = f(x)$$

is of the form

$$2. \quad y(x) = y_c(x) + y_p(x),$$

where the $y_c(x)$ is the general solution of the homogeneous form of the equation $L[y(x)] = 0$ and $y_p(x)$ is a **particular integral** whose form is determined by the inhomogeneous term $f(x)$. The solution $y_c(x)$ may be found by the method given in 22.8.1. The particular integral $y_p(x)$ may be obtained by using the method of **variation of parameters**. The result is

$$3. \quad y_p(x) = \sum_{r=1}^n y_r(x) \int \frac{D_r(x)f(x)}{W[y_1, y_2, \dots, y_n]} dx,$$

where y_1, y_2, \dots, y_n are n linearly independent solutions of $L[y(x)] = 0$, $W[y_1, y_2, \dots, y_n]$ is the Wronskian of these solutions (see 20.1.2.1.2), and $D_r(x)$ is the determinant obtained by replacing the r 'th column of the Wronskian by $(0, 0, \dots, 1)$.

If an **initial value problem** is to be solved, the constants in the general solution $y(x) = y_c(x) + y_p(x)$ must be chosen so that $y(x)$ satisfies the initial conditions.

Example 22.11 Find the particular integral and general solution of

$$\frac{d^3y}{dx^3} + 4\frac{dy}{dx} = \tan 2x, \quad [-\pi/4 < x < \pi/4],$$

and solve the associated initial value problem in which $y(0) = y^{(1)}(0) = y^{(2)}(0) = 0$. In this case

$$L[y(x)] = \frac{d^3y}{dx^3} + 4\frac{dy}{dx},$$

so the characteristic polynomial

$$P_3(\lambda) = \lambda^3 + 4\lambda = \lambda(\lambda^2 + 4).$$

The roots of $P_3(\lambda) = 0$ are $\lambda_1 = 0$, $\lambda_2 = 2i$, and $\lambda_3 = -2i$, so it follows that the three linearly independent solutions of $L[y(x)] = 0$ are

$$y_1(x) = 1, \quad y_2(x) = \cos 2x, \quad \text{and} \quad y_3(x) = \sin 2x,$$

and hence

$$y_c(x) = c_1 + c_2 \cos 2x + c_3 \sin 2x.$$

The Wronskian

$$W[y_1, y_2, y_3] = \begin{vmatrix} 1 & \cos 2x & \sin 2x \\ 0 & -2 \sin 2x & 2 \cos 2x \\ 0 & -4 \cos 2x & -4 \sin 2x \end{vmatrix} = 8,$$

while

$$D_1 = \begin{vmatrix} 0 & \cos 2x & \sin 2x \\ 0 & -2 \sin 2x & 2 \cos 2x \\ 1 & -4 \cos 2x & -4 \sin 2x \end{vmatrix} = 2,$$

$$D_2 = \begin{vmatrix} 1 & 0 & \sin 2x \\ 0 & 0 & 2 \cos 2x \\ 0 & 1 & -4 \sin 2x \end{vmatrix} = -2 \cos 2x,$$

$$D_3 = \begin{vmatrix} 1 & \cos 2x & 0 \\ 0 & -2 \sin 2x & 0 \\ 0 & -4 \cos 2x & 1 \end{vmatrix} = -2 \sin 2x,$$

From 22.10.1.3 we have

$$y_p(x) = \frac{1}{4} \int \tan 2x \, dx - \frac{1}{4} \cos 2x \int \cos 2x \tan 2x \, dx \\ - \frac{1}{4} \sin 2x \int \sin 2x \tan 2x \, dx,$$

so

$$y_p(x) = \frac{1}{8} + \frac{1}{8} \ln[\sec x] - \frac{1}{8} \sin 2x \ln[\sec 2x + \tan 2x].$$

The general solution is

$$y(x) = c_1 + c_2 \cos 2x + c_3 \sin 2x + \frac{1}{8} + \frac{1}{8} \ln[\sec 2x] - \frac{1}{8} \sin 2x \ln[\sec 2x + \tan 2x]$$

for $-\pi/4$, where the term $\frac{1}{8}$ follows by combining the terms $\frac{1}{8}(\cos^2 2x + \sin^2 2x)$.

To solve the initial value problem, the constants c_1 , c_2 , and c_3 in the general solution $y(x)$ must be chosen such that $y(0) = y^{(1)}(0) = y^{(2)}(0) = 0$. The equations for c_1 , c_2 , and c_3 that result when these conditions are used are:

$$\begin{aligned} (y(0) = 0) & \quad c_1 + c_2 = -\frac{1}{8} \\ (y^{(1)}(0) = 0) & \quad 2c_3 = 0 \\ (y^{(2)}(0) = 0) & \quad -4c_2 - \frac{1}{2} = 0, \end{aligned}$$

so $c_1 = 0$, $c_2 = -\frac{1}{8}$, and $c_3 = 0$, and the solution of the initial value problem is

$$y(x) = \frac{1}{8} - \frac{1}{8} \cos 2x - \frac{1}{8} \ln[\sec x] - \frac{1}{8} \sin 2x \ln[\sec 2x + \tan 2x].$$

22.10.2 The Green's Function

Another way of solving initial and boundary value problems for inhomogeneous linear differential equations is in terms of an integral using a specially constructed function called a *Green's function*. In what follows, only the solution of a second order equation will be considered, though the method extends in a straightforward manner to linear inhomogeneous equations of any order.

The Solution of a Linear Inhomogeneous Equation Using a Green's Function

When expressed in terms of the Green's function $G(x, t)$, the solution of an initial value problem for the linear second order inhomogeneous equation

$$1. \quad p(x) \frac{d^2 y}{dx^2} + q(x) \frac{dy}{dx} + r(x)y = f(x),$$

subject to the homogeneous initial conditions

$$2. \quad y(0) = 0 \quad \text{and} \quad y'(0) = 0$$

can be written in the form

$$3. \quad y(x) = \int_0^x G(x, t) f(t) dt,$$

where $G(x, t)$ is the Green's function.

The Green's function can be found by solving the initial value problem

$$4. \quad p(x) \frac{d^2 y}{dx^2} + q(x) \frac{dy}{dx} + r(x)y = 0,$$

subject to the initial conditions

$$5. \quad y(t) = 0 \quad \text{and} \quad y'(t) = 1 \quad \text{for} \quad t < x.$$

This way of finding the Green's function is equivalent to solving equation 1 subject to homogeneous initial conditions, with a Dirac delta function $\delta(x - t)$ as the inhomogeneous term. The linearity of the equation then allows solution 3 to be found by weighting the Green's function response by the inhomogeneous term at $x = t$ and integrating the result with respect to t over the interval $0 \leq t \leq x$.

The **Green's function** can be defined as

$$6. \quad G(x, t) = -\frac{1}{p(x)} \frac{\begin{vmatrix} \varphi_1(x) & \varphi_2(x) \\ \varphi_1(t) & \varphi_2(t) \end{vmatrix}}{\begin{vmatrix} \varphi_1(t) & \varphi_2(t) \\ \varphi_1'(t) & \varphi_2'(t) \end{vmatrix}}, \quad \text{for} \quad 0 \leq t \leq x,$$

where $\varphi_1(x)$ and $\varphi_2(x)$ are two linearly independent solutions of the homogeneous form of equation 1

$$7. \quad p(x) \frac{d^2 y}{dx^2} + q(x) \frac{dy}{dx} + r(x)y = 0.$$

The advantage of the Green's function approach is that $G(x, t)$ is independent of the inhomogeneous term $f(x)$, so once $G(x, t)$ has been found, result 3 gives the solution for any inhomogeneous term $f(x)$.

If the initial conditions for equation 1 are not homogeneous, all that is necessary to modify result 3 is to find a solution of the homogeneous form of the differential equation that satisfies the inhomogeneous initial conditions and then to add it to the result in 3.

Example 22.12 Use the Green's function to solve (a) the initial value problem for

$$y'' + y = \cos x,$$

subject to the homogeneous initial conditions $y(0) = 0$ and $y'(0) = 0$ and (b) the same equation subject to the inhomogeneous initial conditions $y(0) = 2$ and $y'(0) = 0$.

Solution

(a) A solution set $\{\varphi_1(x), \varphi_2(x)\}$ for the homogeneous form of this equation is given by $\varphi_1(x) = \cos x$ and $\varphi_2(x) = \sin x$. As $p(x) = 1$, and the inhomogeneous term $f(x) = \cos x$, the *Green's function* becomes

$$G(x, t) = - \begin{vmatrix} \cos x & \sin x \\ \cos t & \sin t \end{vmatrix} \bigg/ \begin{vmatrix} \cos t & \sin t \\ -\sin t & \cos t \end{vmatrix} = \sin x \cos t - \cos x \sin t = \sin(x - t).$$

Substituting for $G(x, t)$ in 3 and setting $f(t) = \cos t$, gives

$$y(x) = \int_0^x \sin(x - t) \cos t \, dt,$$

so the solution subject to homogeneous initial conditions is

$$y(x) = \frac{1}{2}x \sin x.$$

(b) The general solution of the homogeneous form of the equation is

$$y_C(x) = A \sin x + B \cos x,$$

so if this is to satisfy the inhomogeneous initial conditions $y_C(0) = 2$ and $y'_C(0) = 0$, we must set $A = 0$ and $B = 2$, giving $y_C(x) = 2 \cos x$. Thus the required solution subject to the inhomogeneous initial conditions becomes

$$y(x) = y_C(x) + \int_0^x \sin(x - t) \cos t \, dt, \text{ and so } y(x) = 2 \cos x + \frac{1}{2}x \sin x.$$

When two-point boundary value problems over the interval $a \leq x \leq b$ are considered for equations with inhomogeneous terms, where the solution must satisfy *homogeneous* boundary conditions, it is necessary to modify the definition of a Green's function. To be precise, the solution is required for a **two-point boundary value problem** over the interval $a \leq x \leq b$, for the inhomogeneous equation

$$8. \quad p(x) \frac{d^2 y}{dx^2} + q(x) \frac{dy}{dx} + r(x)y = f(x),$$

that satisfies the **homogeneous two-point boundary conditions**

$$9. \quad \alpha_1 y(a) + \beta_1 y'(a) = 0 \quad \text{and} \quad \alpha_2 y(b) + \beta_2 y'(b) = 0,$$

where the constants $\alpha, \beta_1, \alpha_2$, and β_2 are such that $\alpha_1^2 + \beta_1^2 > 0$ and $\alpha_2^2 + \beta_2^2 > 0$.

The Solution of a Two-Point Boundary Value Problem Using a Green's Function

The solution of boundary value problem for equation 8, subject to the boundary conditions 9, will only exist if the problem is properly set, in the sense that it is possible for the solution to satisfy the boundary conditions. The condition for this is that the homogeneous form of the equation

$$10. \quad p(x) \frac{d^2 y}{dx^2} + q(x) \frac{dy}{dx} + r(x)y = 0,$$

subject to the boundary conditions 9, only has a trivial solution—that is, the only solution is the identically zero solution.

Let $\phi_1(x)$ be a solution of the homogeneous equation 10 that satisfies boundary conditions 9 at $x = a$, and let $\phi_2(x)$ be a linearly independent solution of equation 10 that satisfies boundary conditions 9 at $x = b$. Then the **Green's function** for the homogeneous equation 10 is defined as

$$11. \quad G(x, t) = \begin{cases} \frac{\phi_1(t)\phi_2(x)}{p(t)W[\phi_1(t), \phi_2(t)]} & \text{for } a \leq x \leq t, \\ \frac{\phi_1(x)\phi_2(t)}{p(t)W[\phi_1(t), \phi_2(t)]} & \text{for } t \leq x \leq b. \end{cases}$$

The solution of the two-point boundary value problem for equation 8, subject to the boundary conditions 9, is

$$12. \quad y(x) = \int_a^b G(x, t)b(t)dt,$$

or equivalently

$$13. \quad y(x) = \phi_2(x) \int_a^x \frac{\phi_1(t)b(t)}{p(t)W[\phi_1(t), \phi_2(t)]} dt + \phi_1(x) \int_x^b \frac{\phi_2(t)b(t)}{p(t)W[\phi_1(t), \phi_2(t)]} dt.$$

If required, this form of the solution can be derived by modifying the method of variation of parameters.

Example 22.13 Verify that the two-point boundary value problem

$$y'' + y = 1, \quad y(0) = 0, \quad y(\pi/2) = 0$$

has a solution, and find it with the aid of a Green's function.

Solution The solution of the homogeneous form of the equation $y'' + y = 0$, subject to the boundary conditions $y(0) = 0$, $y(\pi/2) = 0$, only has the trivial solution $y(x) \equiv 0$, so the Green's function method may be used to find the solution $y(x)$.

The function $\phi_1(x)$ must be constructed from a linear combination of the solutions of the homogeneous form of the equation, namely $y'' + y = 0$, with the solution set $\{\varphi_1(x), \varphi_2(x)\}$, where $\varphi_1(x) = \cos x$ and $\varphi_2(x) = \sin x$. So we set $\phi_1(x) = c_1 \cos x + c_2 \sin x$ and require $\phi_1(x)$ to satisfy the left boundary condition $\phi_1(0) = 0$. This shows we must set $\phi_1(x) = c_2 \sin x$. However, the differential equation is homogeneous, so as this solution can be scaled arbitrarily, for simplicity we choose to set $c_2 = 1$, when $\phi_1(x) = \sin x$.

The function $\phi_2(x)$ must also be constructed from a linear combination of solutions of the homogeneous form of the equation $y'' + y = 0$, so now we set $\phi_2(x) = d_1 \cos x + d_2 \sin x$ and require $\phi_2(x)$ to satisfy the right boundary condition $\phi_2(\pi/2) = 0$. This shows that $\phi_2(x) = d_2 \cos x$, but again, as the differential equation is homogeneous, this solution can also be scaled arbitrarily. So, for simplicity, we choose to set $d_1 = 1$ when $\phi_2(x) = \cos x$.

In this case $p(x) = 1$, and the Wronskian

$$W[\phi_1(x), \phi_2(x)] = \begin{vmatrix} \sin x & \cos x \\ \cos x & -\sin x \end{vmatrix} = -1,$$

so the Green's function

$$G(x, t) = \begin{cases} -\sin t \cos x, & 0 \leq x \leq t \\ -\sin x \cos t, & t \leq x \leq \pi/2. \end{cases}$$

As the inhomogeneous term $f(x) = 1$, we must set $f(t) = 1$, showing the solution of the boundary value problem is given by

$$y(x) = -\int_0^x \sin t \cos x \, dt - \int_x^{\pi/2} \sin x \cos t \, dt,$$

so the required solution is

$$y(x) = 1 - \cos x - \sin x.$$

To illustrate the necessity for the homogeneous form of the equation to have a trivial solution if the solution of the two-point boundary value problem is to exist, we need only consider the equation $y'' + y = 1$ subject to the boundary conditions $y(0) = 0$ and $y(\pi) = 0$. The

homogeneous form of the equation has the *non-trivial* solution $y_0(x) = k \sin x$ for any constant $k \neq 0$, and this function satisfies *both* of the boundary conditions. The general solution of the equation is easily shown to be $y(x) = C_1 \cos x + C_2 \sin x + 1$, so the left boundary condition $y(0) = 0$ is satisfied provided $C_1 = -1$, leading to the result that $y(x) = C_2 \sin x - \cos x + 1$. The second boundary condition $y(\pi) = 0$ cannot be satisfied because when it is substituted into $y(x)$, it produces the contradiction that $0 = 2$, showing this two-point boundary value problem has no solution.

22.11 LINEAR INHOMOGENEOUS SECOND-ORDER EQUATION

22.11.1

When the method of 22.10.1 is applied to the solution of the inhomogeneous second-order constant coefficient equation

$$1. \quad \frac{d^2 y}{dx^2} + a \frac{dy}{dx} + by = f(x),$$

the general solution assumes a simpler form depending on the discriminant $a^2 - 4b$.

Case 1. If $a^2 - 4b > 0$ the general solution is

$$2. \quad y(x) = c_1 e^{m_1 x} + c_2 e^{m_2 x} + \frac{e^{m_1 x}}{m_1 - m_2} \int e^{-m_1 x} f(x) dx - \frac{e^{m_2 x}}{m_1 - m_2} \int e^{-m_2 x} f(x) dx,$$

where

$$3. \quad m_1 = \frac{1}{2} [-a - \sqrt{a^2 - 4b}] \quad \text{and} \quad m_2 = \frac{1}{2} [-a + \sqrt{a^2 - 4b}].$$

Case 2. If $a^2 - 4b = 0$ the general solution is

$$4. \quad y(x) = c_1 e^{m_1 x} + c_2 e^{m_1 x} - e^{m_1 x} \int x e^{-m_1 x} f(x) dx + e^{m_1 x} \int e^{-m_1 x} f(x) dx,$$

where

$$5. \quad m_1 = -\frac{1}{2}a.$$

Case 3. If $a^2 - 4b < 0$ the general solution is

$$6. \quad y(x) = e^{\alpha x} (c_1 \cos \beta x + c_2 \sin \beta x) + \frac{e^{\alpha x} \sin \beta x}{\beta} \int e^{-\alpha x} f(x) \cos \beta x dx \\ - \frac{e^{\alpha x} \cos \beta x}{\beta} \int e^{\alpha x} f(x) \sin \beta x dx,$$

where

$$7. \quad \alpha = -\frac{1}{2}a \quad \text{and} \quad \beta = \frac{1}{2}\sqrt{4b - a^2}.$$

22.12 DETERMINATION OF PARTICULAR INTEGRALS BY THE METHOD OF UNDETERMINED COEFFICIENTS

22.12.1

An alternative method may be used to find a particular integral when the inhomogeneous term $f(x)$ is simple in form. Consider the linear inhomogeneous n 'th-order constant coefficient differential equation

$$1. \quad y^{(n)} + a_1y^{(n-1)} + a_2y^{(n-2)} + \cdots + a_ny = f(x),$$

in which the inhomogeneous term $f(x)$ is a polynomial, an exponential, a product of a power of x , and a trigonometric function of the form $x^s \cos qx$ or $x^s \sin qx$ or a sum of any such terms. Then the particular integral may be obtained by the **method of undetermined coefficients (constants)**.

To arrive at the general form of the particular integral it is necessary to proceed as follows:

- (i) If $f(x) = \text{constant}$, include in $y_p(x)$ the undetermined constant term C .
- (ii) If $f(x)$ is a polynomial of degree r then:
 - (a) if $L[y(x)]$ contains an undifferentiated term y , include in $y_p(x)$ terms of the form

$$A_0x^r + A_1x^{r-1} + \cdots + A_r,$$

where A_0, A_1, \dots, A_r are undetermined constants;

- (b) if $L[y(x)]$ does not contain an undifferentiated y , and its lowest order derivative is $y^{(s)}$, include in $y_p(x)$ terms of the form

$$A_0x^{r+s} + A_1x^{r+s-1} + \cdots + A_r x^s,$$

where A_0, A_1, \dots, A_r are undetermined constants.

- (iii) If $f(x) = e^{\alpha x}$ then:
 - (a) if $e^{\alpha x}$ is not contained in the complementary function (it is not a solution of the homogeneous form of the equation), include in $y_p(x)$ the term $Be^{\alpha x}$, where B is an undetermined constant;
 - (b) if the complementary function contains the terms $e^{\alpha x}, xe^{\alpha x}, \dots, x^m e^{\alpha x}$, include in $y_p(x)$ the term $Bx^{m+1}e^{\alpha x}$, where B is an undetermined constant.

(iv) If $f(x) = \cos qx$ and/or $\sin qx$ then:

- (a) if $\cos qx$ and/or $\sin qx$ are not contained in the complementary function (they are not solutions of the homogeneous form of the equation), include in $y_p(x)$ terms of the form

$$C \cos qx \quad \text{and} \quad D \sin qx,$$

where C and D are undetermined constants;

- (b) if the complementary function contains terms $x^s \cos qx$ and/or $x^s \sin qx$ with $s = 0, 1, 2, \dots, m$, include in $y_p(x)$ terms of the form

$$x^{m+1} (C \cos qx + D \sin qx),$$

where C and D are undetermined constants.

- (v) The general form of the particular integral is then the sum of all the terms generated in (i) to (iv).
 (vi) The unknown constant coefficients occurring in $y_p(x)$ are found by substituting $y_p(x)$ into 22.12.1.1, and then choosing them so that the result becomes an identity in x .

Example 22.14 Find the complementary function and particular integral of

$$\frac{d^2 y}{dx^2} + \frac{dy}{dx} - 2y = x + \cos 2x + 3e^x,$$

and solve the associated initial value problem in which $y(0) = 0$ and $y^{(1)}(0) = 1$.

The characteristic polynomial

$$\begin{aligned} P_2(\lambda) &= \lambda^2 + \lambda - 2 \\ &= (\lambda - 1)(\lambda + 2), \end{aligned}$$

so the linearly independent solutions of the homogeneous form of the equation are

$$y_1(x) = e^x \quad \text{and} \quad y_2(x) = e^{-2x},$$

and the complementary function is

$$y_c(x) = c_1 e^x + c_2 e^{-2x}.$$

Inspection of the inhomogeneous term shows that only the exponential e^x is contained in the complementary function. It then follows from (ii) that, corresponding to the term x , we must include in $y_p(x)$ terms of the form

$$A + Bx.$$

Similarly, from (iv)(a), corresponding to the term $\cos 2x$, we must include in $y_p(x)$ terms of the form

$$C \cos 2x + D \sin 2x.$$

Finally, from (iii)(b), it follows that, corresponding to the term e^x , we must include in $y_p(x)$ a term of the form

$$Exe^x.$$

Then from (v) the general form of the particular integral is

$$y_p(x) = A + Bx + C \cos 2x + D \sin 2x + Exe^x.$$

To determine the unknown coefficients A , B , C , D , and E we now substitute $y_p(x)$ into the original equation to obtain

$$(-6C + 2D) \cos 2x - (2C + 6D) \sin 2x + 3Ee^x - 2Bx + B - 2A = x + \cos 2x + 3e^x.$$

For this to become an identity, the coefficients of corresponding terms on either side of this expression must be identical:

$$\begin{array}{ll} \text{(Coefficients of } \cos 2x) & -6C + 2D = 1 \end{array}$$

$$\begin{array}{ll} \text{(Coefficients of } \sin 2x) & -2C - 6D = 0 \end{array}$$

$$\begin{array}{ll} \text{(Coefficients of } x) & -2B = 1 \end{array}$$

$$\begin{array}{ll} \text{(Coefficients of } e^x) & 3E = 3 \end{array}$$

$$\begin{array}{ll} \text{(Coefficients of constant terms)} & B - 2A = 0 \end{array}$$

Thus $A = -\frac{1}{4}$, $B = -\frac{1}{2}$, $C = -\frac{3}{20}$, $D = \frac{1}{20}$, $E = 1$, and hence the required particular integral is

$$y_p(x) = -\frac{1}{4} - \frac{1}{2}x - \frac{3}{20} \cos 2x + \frac{1}{20} \sin 2x + xe^x,$$

while the general solution is

$$y(x) = y_c(x) + y_p(x).$$

The solution of the initial value problem is obtained by selecting the constants c_1 and c_2 in $y(x)$ so that $y(0) = 0$ and $y'(0) = 1$. The equations for c_1 and c_2 that result when these conditions are used are:

$$\begin{aligned} (y(0) = 0) \quad c_1 + c_2 - \frac{2}{5} &= 0 \\ (y'(0) = 1) \quad c_1 - 2c_2 + \frac{3}{5} &= 1, \end{aligned}$$

so $c_1 = 2/5$ and $c_2 = 0$ and the solution of the initial value problem is

$$y(x) = e^x \left[x + \frac{2}{5} \right] - \frac{3}{20} \cos 2x + \frac{1}{20} \sin 2x - \frac{1}{2}x - \frac{1}{4}.$$

22.13 THE CAUCHY–EULER EQUATION

22.13.1

The **Cauchy–Euler equation** of order n is of the form

$$1. \quad x^n y^{(n)} + a_1 x^{n-1} y^{(n-1)} + \cdots + a_n y = f(x),$$

where a_1, a_2, \dots, a_n are constants.

The change of variable

$$2. \quad x = e^t$$

reduces the equation to a linear constant coefficient equation with the inhomogeneous term $f(e^t)$, which may be solved by the method described in 22.10.1.

In the special case of the Cauchy–Euler equation of order 2, which may be written

$$3. \quad x^2 \frac{d^2 y}{dx^2} + a_1 x \frac{dy}{dx} + a_2 y = f(x),$$

the change of variable 22.13.1.2 reduces it to

$$\frac{d^2 y}{dt^2} + (a_1 - 1) \frac{dy}{dt} + a_2 y = f(e^t).$$

The following solution of the homogeneous Cauchy–Euler equation of order 2 is often useful: If

$$4. \quad x^2 \frac{d^2 y}{dx^2} + a_1 x \frac{dy}{dx} + a_2 y = 0,$$

and λ_1, λ_2 are the roots of the polynomial equation

$$5. \quad \lambda^2 + (a_1 - 1)\lambda + a_2 = 0,$$

then, provided $x \neq 0$, the general solution of 22.13.1.4 is

$$6. \quad \begin{aligned} y_c(x) &= c_1 |x|^{\lambda_1} + c_2 |x|^{\lambda_2}, & \text{if } \lambda_1 \neq \lambda_2 \text{ are both real,} \\ y_c(x) &= (c_1 + c_2 \ln |x|) |x|^{\lambda_1}, & \text{if } \lambda_1 \text{ and } \lambda_2 \text{ are real and } \lambda_1 = \lambda_2, \\ y_c(x) &= x^\alpha [c_1 \cos(\beta \ln |x|) + c_2 \sin(\beta \ln |x|)], & \text{if } \lambda_1 \text{ and } \lambda_2 \text{ are complex conjugates} \end{aligned}$$

with $\lambda_1 = \alpha + i\beta$ and $\lambda_2 = \alpha - i\beta$.

22.14 LEGENDRE'S EQUATION

22.14.1

Legendre's equation is

$$1. \quad (1 - x^2) \frac{d^2 y}{dx^2} - 2x \frac{dy}{dx} + n(n + 1)y = 0,$$

where $n = 0, 1, 2, \dots$

The general solution is

$$2. \quad y(x) = c_1 P_n(x) + c_2 Q_n(x),$$

where $P_n(x)$ is the Legendre polynomial of degree n and $Q_n(x)$ is Legendre function of the second kind (see 18.2.4.2 and 18.2.7.1).

22.15 BESSEL'S EQUATIONS

22.15.1

Bessel's equation is

$$1. \quad x^2 \frac{d^2 y}{dx^2} + x \frac{dy}{dx} + (\lambda^2 x^2 - \nu^2) y = 0.$$

The general solution is

$$2. \quad y(x) = c_1 J_\nu(\lambda x) + c_2 Y_\nu(\lambda x),$$

where J_ν is the Bessel function of the first kind of order ν and Y_ν is the Bessel function of the second kind of order ν (see 17.2.1 and 17.2.2). **Bessel's modified equation** is

$$3. \quad x^2 \frac{d^2 y}{dx^2} + x \frac{dy}{dx} - (\lambda^2 x^2 + \nu^2) y = 0.$$

The general solution is

$$4. \quad y(x) = c_1 I_\nu(\lambda x) + c_2 K_\nu(\lambda x),$$

where I_ν is the modified Bessel function of the first kind of order ν and K_ν is the modified Bessel function of the second kind of order ν (see 17.7.1 and 17.7.2).

Example 22.15 Solve the two-point boundary value problem

$$x^2 \frac{d^2 y}{dx^2} + x \frac{dy}{dx} + \lambda^2 x^2 = 0,$$

subject to the boundary conditions $y(0) = 2$ and $y^{(1)}(a) = 0$.

The equation is Bessel's equation of order 0, so the general solution is

$$y(x) = c_1 J_0(\lambda x) + c_2 Y_0(\lambda x).$$

The boundary condition $y(0) = 2$ requires the solution to be finite at the origin, but $Y_0(0)$ is *infinite* (see 17.2.2.2.1) so we must set $c_2 = 0$ and require that $2 = c_1 J_0(0)$, so $c_1 = 2$ because $J_0(0) = 1$ (see 17.2.1.2.1). Boundary condition $y(a) = 0$ then requires that

$$0 = 2J_0(\lambda a),$$

but the zeros of $J_0(x)$ are $j_{0,1}, j_{0,2}, \dots, j_{0,m}, \dots$ (see Table 17.1), so $\lambda a = j_{0,m}$, or $\lambda_m = j_{0,m}/a$, for $m = 1, 2, \dots$. Consequently, the required solutions are

$$y_m(x) = 2J_0\left(\frac{j_{0,m}x}{a}\right) \quad [m = 1, 2, \dots].$$

The numbers $\lambda_1, \lambda_2, \dots$ are the **eigenvalues** of the problem and the functions y_1, y_2, \dots , are the corresponding **eigenfunctions**. Because any constant multiple of $y_m(x)$ is also a solution, it is usual to omit the constant multiplier 2 in these eigenfunctions.

Example 22.16 Solve the two-point boundary value problem

$$x^2 \frac{d^2 y}{dx^2} + x \frac{dy}{dx} - (x^2 + 4)y = 0,$$

subject to the boundary conditions $y(a) = 0$ and $y(b) = 0$ with $0 < a < b < \infty$.

The equation is Bessel's modified equation of order 2, so the general solution is

$$y(x) = c_1 I_2(\lambda x) + c_2 K_2(\lambda x).$$

Since $0 < a < b < \infty$, I_2 , and K_2 are *finite* in the interval $a \leq x \leq b$, so both must be retained in the general solution (see 17.7.1.2 and 17.7.2.2).

Application of the boundary conditions leads to the conditions:

$$\begin{aligned} (y(a) = 0) \quad c_1 I_2(\lambda a) + c_2 K_2(\lambda a) &= 0 \\ (y(b) = 0) \quad c_1 I_2(\lambda b) + c_2 K_2(\lambda b) &= 0, \end{aligned}$$

and this homogeneous system only has a nontrivial solution (c_1, c_2 not both zero) if

$$\begin{vmatrix} I_2(\lambda a) & K_2(\lambda a) \\ I_2(\lambda b) & K_2(\lambda b) \end{vmatrix} = 0.$$

Thus, the required values $\lambda_1, \lambda_2, \dots$ of λ must be the zeros of the transcendental equation

$$I_2(\lambda a)K_2(\lambda b) - I_2(\lambda b)K_2(\lambda a) = 0.$$

For a given a, b it is necessary to determine $\lambda_1, \lambda_2, \dots$, numerically. Here also the numbers $\lambda_1, \lambda_2, \dots$, are the **eigenvalues** of the problem, and the functions

$$y_m(x) = c_1 \left[I_2(\lambda_m x) - \frac{I_2(\lambda_m a)}{K_2(\lambda_m a)} K_2(\lambda_m x) \right]$$

or, equivalently,

$$y_m(x) = c_1 \left[I_2(\lambda_m x) - \frac{I_2(\lambda_m b)}{K_2(\lambda_m b)} K_2(\lambda_m x) \right],$$

are the corresponding **eigenfunctions**. As in Example 22.15, because any multiple of $y_m(x)$ is also a solution, it is usual to set $c_1 = 1$ in the eigenfunctions.

22.16 POWER SERIES AND FROBENIUS METHODS

22.16.1

To appreciate the need for the Frobenius method when finding solutions of linear variable coefficient differential equations, it is first necessary to understand the power series method and the reason for its failure in certain circumstances.

To illustrate the **power series method**, consider seeking a solution of

$$\frac{d^2 y}{dx^2} + x \frac{dy}{dx} + y = 0$$

in the form of a power series about the origin

$$y(x) = \sum_{n=0}^{\infty} a_n x^n.$$

Differentiation of this expression to find dy/dx and $d^2 y/dx^2$, followed by substitution into the differential equation and the grouping of terms leads to the result

$$(a_0 + 2a_2) + \sum_{n=1}^{\infty} [(n+1)(n+2)a_{n+2} + (n+1)a_n] x^n = 0.$$

For $y(x)$ to be a solution, this expression must be an identity for all x , which is only possible if $a_0 + 2a_2 = 0$ and the coefficient of every power of x vanishes, so that

$$(n+1)(n+2)a_{n+2} + (n+1)a_n = 0 \quad [n = 1, 2, \dots].$$

Thus, $a_2 = -\frac{1}{2}a_0$, and in general the coefficients a_n are given recursively by

$$a_{n+2} = -\left(\frac{1}{n+2}\right)a_n.$$

from which it follows that a_2, a_4, a_6, \dots are all expressible in terms of an arbitrary nonzero constant a_0 , while a_1, a_3, a_5, \dots are all expressible in terms of an arbitrary nonzero constant a_1 . Routine calculations then show that

$$a_{2m} = \frac{(-1)^m}{2^m m!} a_0 \quad [m = 1, 2, \dots],$$

while

$$a_{2m+1} = \frac{(-1)^m}{1.3.5 \cdots (2m+1)} a_1 \quad [m = 1, 2, \dots].$$

After substituting for the a_n in the power series for $y(x)$ the solution can be written

$$\begin{aligned} y(x) &= a_0 \sum_{m=0}^{\infty} \frac{(-1)^m}{2^m m!} x^{2m} + a_1 \sum_{m=0}^{\infty} \frac{(-1)^m}{1.3.5 \cdots (2m+1)} x^{2m+1} \\ &= a_0 \left(1 - \frac{1}{2}x + \frac{1}{8}x^2 - \cdots\right) + a_1 \left(x - \frac{1}{3}x^3 + \frac{1}{15}x^5 - \cdots\right). \end{aligned}$$

Setting

$$y_1(x) = 1 - \frac{1}{2}x + \frac{1}{8}x^2 - \cdots \quad \text{and} \quad y_2(x) = x - \frac{1}{3}x^3 + \frac{1}{15}x^5 - \cdots,$$

it follows that y_1 and y_2 are linearly independent, because y_1 is an even function and y_2 is an odd function. Thus, because a_0, a_1 are arbitrary constants, the general solution of the differential equation can be written

$$y(x) = a_0 y_1(x) + a_2 y_2(x).$$

The power series method was successful in this case because the coefficients of d^2y/dx^2 , dy/dx and y in the differential equation were all capable of being expressed as Maclaurin series, and so could be combined with the power series expression for $y(x)$ and its derivatives that led to $y_1(x)$ and $y_2(x)$. (In this example, the coefficients 1, x , and 1 in the differential equation are their own Maclaurin series.) The method fails if the variable coefficients in a differential equation cannot be expressed as Maclaurin series (they are not analytic at the origin).

The **Frobenius method** overcomes the difficulty just outlined for a wide class of variable coefficient differential equations by generalizing the type of solution that is sought. To proceed further, it is first necessary to define regular and singular points of a differential equation.

The second-order linear differential equation with variable coefficients

$$1. \quad \frac{d^2y}{dx^2} + p(x)\frac{dy}{dx} + q(x)y = 0$$

is said to have a **regular point** at the origin if $p(x)$ and $q(x)$ are analytic at the origin. If the origin is *not* a regular point it is called a **singular point**. A singular point at the origin is called a **regular singular point** if

$$2. \quad \lim_{x \rightarrow 0} \{xp(x)\} \text{ is finite}$$

and

$$3. \quad \lim_{x \rightarrow 0} \{x^2q(x)\} \text{ is finite.}$$

Singular points that are not regular are said to be **irregular**. The behavior of a solution in a neighborhood of an irregular singular point is difficult to determine and very erratic, so this topic is not discussed further.

There is no loss of generality involved in only considering an equation with a regular singular point located at the origin, because if such a point is located at x_0 the transformation $X = x - x_0$ will shift it to the origin.

If the behavior of a solution is required for large x (an asymptotic solution), making the transformation $x = 1/z$ in the differential equation enables the behavior for large x to be determined by considering the case of small z . If $z = 0$ is a regular point of the transformed equation, the original equation is said to have **regular point at infinity**. If, however, $z = 0$ is a regular singular point of the transformed equation, the original equation is said to have a **regular singular point at infinity**.

The **Frobenius method** provides the solution of the differential equation

$$4. \quad \frac{d^2y}{dx^2} + p(x)\frac{dy}{dx} + q(x)y = 0$$

in a neighborhood of a regular singular point located at the origin. Remember that if the regular singular point is located at x_0 , the transformation $X = x - x_0$ reduces the equation to the preceding case.

A solution is sought in the form

$$5. \quad y(x) = x^\lambda \sum_{n=0}^{\infty} a_n x^n \quad [a_0 \neq 0],$$

where the number λ may be either real or complex, and is such that $a_0 \neq 0$.

Expressing $p(x)$ and $q(x)$ as their Maclaurin series

$$6. \quad p(x) = p_0 + p_1(x) + p_2x^2 + \cdots \text{ and } q(x) = q_0 + q_1(x) + q_2x^2 + \cdots,$$

and substituting for $y(x)$, $p(x)$ and $q(x)$ in 22.16.1.4, as in the power series method, leads to an identity involving powers of x , in which the coefficient of the lowest power x^λ is given by

$$[\lambda(\lambda - 1) + p_0\lambda + q_0]a_0 = 0.$$

Since, by hypothesis, $a_0 \neq 0$, this leads to the **indicial equation**

$$7. \quad \lambda(\lambda - 1) + p_0\lambda + q_0 = 0,$$

from which the permissible values of the exponent λ may be found.

The form of the two linearly independent solutions $y_1(x)$ and $y_2(x)$ of 22.16.1.4 is determined as follows:

Case 1. If the indicial equation has distinct roots λ_1 and λ_2 that do not differ by an integer, then for $x > 0$

$$8. \quad y_1(x) = x^{\lambda_1} \sum_{n=0}^{\infty} a_n x^n$$

and

$$9. \quad y_2(x) = x^{\lambda_2} \sum_{n=0}^{\infty} b_n x^n,$$

where the coefficients a_n and b_n are found recursively in terms of a_0 and b_0 , as in the power series method, by equating to zero the coefficient of the general term in the identity in powers of x that led to the indicial equation, and first setting $\lambda = \lambda_1$ and then $\lambda = \lambda_2$. Here the coefficients in the solution for $y_2(x)$ have been denoted by b_n , instead of a_n , to avoid confusion with the coefficients in $y_1(x)$. The same convention is used in Cases 2 and 3, which follow.

Case 2. If the indicial equation has a double root $\lambda_1 = \lambda_2 = \lambda$, then

$$10. \quad y_1(x) = x^\lambda \sum_{n=0}^{\infty} a_n x^n$$

and

$$11. \quad y_2(x) = y_1(x) \ln |x| + x^\lambda \sum_{n=1}^{\infty} b_n x^n.$$

Case 3. If the indicial equation has roots λ_1 and λ_2 that differ by an integer and $\lambda_1 > \lambda_2$, then

$$12. \quad y_1(x) = x^{\lambda_1} \sum_{n=0}^{\infty} a_n x^n$$

and

$$13. \quad y_2(x) = Ky_1(x) \ln|x| + x^{\lambda_2} \sum_{n=0}^{\infty} b_n x^n,$$

where K may be zero.

In all three cases the coefficients a_n in the solutions $y_1(x)$ are found recursively in terms of the arbitrary constant $a_0 \neq 0$, as already indicated. In Case 1 the solution $y_2(x)$ is found in the same manner, with the coefficients b_n being found recursively in terms of the arbitrary constant $b_0 \neq 0$. However, the solutions $y_2(x)$ in Cases 2 and 3 are more difficult to obtain. One technique for finding $y_2(x)$ involves using a variant of the method of variation of parameters (see 22.10.1). If $x < 0$ replace x^λ by $|x|^\lambda$ in results 5 to 13.

If $y_1(x)$ is a known solution of

$$14. \quad \frac{d^2y}{dx^2} + p(x)\frac{dy}{dx} + q(x)y = 0,$$

a second linearly independent solution can be shown to have the form

$$15. \quad y_2(x) = y_1(x)v(x),$$

where

$$16. \quad v(x) = \int \frac{\exp[-\int p(x)dx]}{[y_1(x)]^2} dx.$$

This is called the **integral method** for the determination of a second linearly independent solution in terms of a known solution. Often the integral determining $v(x)$ cannot be evaluated analytically, but if the numerator and denominator of the integrand are expressed in terms of power series, the method of 1.11.1.4 may be used to determine their quotient, which may then be integrated term by term to obtain $v(x)$, and hence $y_2(x)$ in the form $y_2(x) = y_1(x)v(x)$. This method will generate the logarithmic term automatically when it is required.

Example 22.17 (distinct roots λ_1, λ_2 not differing by an integer). The differential equation

$$x \frac{d^2y}{dx^2} + \left(\frac{1}{2} - x\right) \frac{dy}{dx} + 2y = 0$$

has a regular singular point at the origin.

The indicial equation is

$$\lambda \left(\lambda - \frac{1}{2} \right) = 0,$$

which corresponds to Case 1 because

$$\lambda_1 = 0, \lambda_2 = \frac{1}{2}.$$

The coefficient of $x^{n+\lambda-1}$ obtained when the Frobenius method is used is

$$a_n(n+\lambda)\left(n+\lambda-\frac{1}{2}\right) + a_{n-1}(n+\lambda-3) = 0,$$

so the recursion formula relating a_n to a_{n-1} is

$$a_n = \frac{(n+\lambda-3)}{(n+\lambda)\left(n+\lambda-\frac{1}{2}\right)} a_{n-1}.$$

Setting $\lambda = \lambda_1 = 0$ we find that

$$a_1 = -4a_0, \quad a_2 = \frac{4}{3}a_0 \quad \text{and} \quad a_n = 0 \text{ for } n > 2.$$

The corresponding solution

$$y_1(x) = a_0\left(1 - 4x + \frac{4}{3}x^2\right)$$

is simply a second-degree polynomial.

Setting $\lambda = \lambda_2 = \frac{1}{2}$, a routine calculation shows the coefficient b_n is given by

$$b_n = \frac{b_1}{(4n^2 - 1)(2n - 3)n!},$$

so the second linearly independent solution is

$$y_2(x) = b_0 \sum_{n=0}^{\infty} \frac{x^{n+1/2}}{(4n^2 - 1)(2n - 3)n!}.$$

Example 22.18 (equal roots $\lambda_1 = \lambda_2 = \lambda$). The differential equation

$$x \frac{d^2 y}{dx^2} + (1-x) \frac{dy}{dx} + y = 0$$

has a regular singular point at the origin.

The indicial equation is

$$\lambda^2 = 0,$$

which corresponds to Case 2 since $\lambda_1 = \lambda_2 = 0$ is a repeated root.

The recursion formula obtained as in Example 22.17 is

$$a_n = \frac{(n + \lambda - 2)}{(n + \lambda)^2} a_{n-1}.$$

Setting $\lambda = 0$ then shows that one solution is

$$y_1(x) = a_0(1 - x).$$

Using the integral method to find $y_2(x)$ leads to the second linearly independent solution

$$y_2(x) = b_0(1 - x) \left[\ln|x| + 3x + \frac{11}{4}x^2 + \frac{49}{18}x^3 + \cdots \right],$$

in which there is no simple formula for the general term in the series.

Example 22.19 (roots λ_1, λ_2 that differ by an integer). The differential equation

$$x \frac{d^2y}{dx^2} - x \frac{dy}{dx} + 2y = 0$$

has a regular singular point at the origin.

The indicial equation is

$$\lambda(\lambda - 1) = 0,$$

which corresponds to Case 3 because $\lambda_1 = 1$ and $\lambda_2 = 0$.

The recursion formula obtained as in Example 22.17 is

$$a_n = \frac{(n + \lambda - 3)}{(n + \lambda)(n + \lambda - 1)} \quad [n \geq 1].$$

Setting $\lambda = 1$ shows one solution to be

$$y_1(x) = a_0 \left(x - \frac{1}{2}x^2 \right).$$

Using the integral method to find $y_2(x)$ leads to the second linearly independent solution

$$y_2(x) = 2 \left(x - \frac{1}{2}x^2 \right) \ln|x| + \left(-1 + \frac{1}{2}x + \frac{9}{4}x^2 + \cdots \right),$$

where again there is no simple formula for the general term in the series.

22.17 THE HYPERGEOMETRIC EQUATION

22.17.1

The **hypergeometric equation** due to Gauss contains, as special cases, many of the differential equations whose solutions are the special functions that arise in applications.

The general **hypergeometric equation** has the form

$$1. \quad x(1-x)\frac{d^2y}{dx^2} - [(a+b+1)x-c]\frac{dy}{dx} - aby = 0,$$

in which a , b , and c are real constants.

Using the Frobenius method the equation can be shown to have the general solution

$$2. \quad y(x) = Ay_1(x) + By_2(x),$$

where, for $|x| < 1$ and $c \neq 0, 1, 2, \dots$,

$$\begin{aligned} 3. \quad y_1(x) &= F(a, b, c; x) \\ &= 1 + \frac{ab}{c}x + \frac{a(a+1)b(b+1)}{c(c+1)}\frac{x^2}{2!} \\ &\quad + \frac{a(a+1)(a+2)b(b+1)(b+2)}{c(c+1)(c+2)}\frac{x^3}{3!} + \dots \end{aligned}$$

$$4. \quad y_2(x) = x^{1-c}F(a-c+1, b-c+1, 2-c; x);$$

and for $|x| > 1$, $a-b \neq 0, 1, 2, \dots$,

$$5. \quad y_1(x) = x^{-a}F(a, a-c+1, a-b+1; x^{-1})$$

$$6. \quad y_2(x) = x^{-b}F(b, b-c+1, b-a+1; x^{-1});$$

while for $(x-1) < 1$, $a+b-c \neq 0, 1, 2, \dots$,

$$7. \quad y_1(x) = F(a, b, a+b-c+1; 1-x)$$

$$8. \quad y_2(x) = (1-x)^{c-a-b}F(c-b, c-a, c-a-b+1; 1-x).$$

The **confluent hypergeometric equation** has the form

$$9. \quad x\frac{d^2y}{dx^2} + (c-x)\frac{dy}{dx} - by = 0,$$

with b and c real constants, and the general solution obtained by the Frobenius method

$$10. \quad y(x) = Ay_1(x) + By_2(x),$$

where for $c \neq 0, 1, 2, \dots$,

$$11. \quad y_1(x) = F(b, c; x) = 1 + \frac{b}{c}x + \frac{b(b+1)}{c(c+1)} \frac{x^2}{2!} + \frac{b(b+1)(b+2)}{c(c+1)(c+2)} \frac{x^3}{3!} + \dots$$

$$12. \quad y_2(x) = x^{1-c} F(b-c+1, 2-c; x).$$

22.18 NUMERICAL METHODS

22.18.1

When numerical solutions to initial value problems are required that cannot be obtained by analytical means it is necessary to use numerical methods. From the many methods that exist we describe in order of increasing accuracy only Euler's method, the modified Euler method, the fourth-order Runge-Kutta method and the Runge-Kutta-Fehlberg method. The section concludes with a brief discussion of how methods for the solution of initial value problems can be used to solve two-point boundary value problems for second-order equations.

Euler's method. The **Euler method** provides a numerical approximation to the solution of the initial value problem

$$1. \quad \frac{dy}{dx} = f(x, y),$$

which is subject to the initial condition

$$2. \quad y(x_0) = y_0.$$

Let each increment (step) in x be h , so that at the n th step

$$3. \quad x_n = x_0 + nh.$$

Then the Euler algorithm for the determination of the approximation y_{n+1} to $y(x_{n+1})$ is

$$4. \quad y_{n+1} = y_n + f(x_n, y_n)h.$$

The method uses a tangent line approximation to the solution curve through (x_n, y_n) in order to determine the approximation y_{n+1} to $y(x_{n+1})$. The local error involved is $O(h^2)$. The method does not depend on equal step lengths at each stage of the calculation, and if the solution changes rapidly the step length may be reduced in order to control the local error.

Modified Euler method. The **modified Euler method** is a simple refinement of the Euler method that takes some account of the curvature of the solution curve through (x_n, y_n)

when estimating y_{n+1} . The modification involves taking as the gradient of the tangent line approximation at (x_n, y_n) the average of the gradients at (x_n, y_n) and (x_{n+1}, y_{n+1}) as determined by the Euler method.

The algorithm for the modified Euler method takes the following form: If

$$5. \quad \frac{dy}{dx} = f(x, y),$$

subject to the initial condition

$$6. \quad y(x_0) = y_0,$$

and all steps are of length h , so that after n steps

$$7. \quad x_n = x_0 + nh,$$

then

$$8. \quad y_{n+1} = y_n + \frac{h}{2} [f(x_n, y_n) + f(x_n + h, y_n) + f(x_n, y_n)h].$$

The local error involved when estimating y_{n+1} from y_n is $O(h^3)$. Here, as in the Euler method, if required the step length may be changed as the calculation proceeds.

Runge–Kutta Fourth-Order Method. The **Runge–Kutta (R–K) fourth-order method** is an accurate and flexible method based on a Taylor series approximation to the function $f(x, y)$ in the initial value problem

$$9. \quad \frac{dy}{dx} = f(x, y)$$

subject to the initial condition

$$10. \quad y(x_0) = y_0.$$

The increment h in x may be changed at each step, but it is usually kept constant so that after n steps

$$11. \quad x_n = x_0 + nh.$$

The Runge–Kutta algorithm for the determination of the approximation y_{n+1} to $y(x_{n+1})$ is

$$12. \quad y_{n+1} = y_n + \frac{1}{6} (k_1 + 2k_2 + 2k_3 + k_4),$$

where

$$13. \quad k_1 = hf(x_n, y_n)$$

$$k_2 = hf\left(x_n + \frac{1}{2}h, y_n + \frac{1}{2}k_1\right)$$

$$k_3 = hf\left(x_n + \frac{1}{2}h, y_n + \frac{1}{2}k_2\right)$$

$$k_4 = hf(x_{n+1}, y_n + k_3).$$

The local error involved in the determination of y_{n+1} from y_n is $O(h^5)$.

The Runge–Kutta Method for Systems. The Runge–Kutta method extends immediately to the solution of problems of the type

$$14. \quad \frac{dy}{dx} = f(x, y, z)$$

$$15. \quad \frac{dz}{dx} = g(x, y, z),$$

subject to the initial conditions

$$16. \quad y(x_0) = y_0 \quad \text{and} \quad z(x_0) = z_0.$$

At the n th integration step, using a step of length h , the Runge–Kutta algorithm for the system takes the form

$$17. \quad y_{n+1} = y_n + \frac{1}{6}(k_1 + 2k_2 + 2k_3 + k_4)$$

$$18. \quad z_{n+1} = z_n + \frac{1}{6}(K_1 + 2K_2 + 2K_3 + K_4),$$

where

$$19. \quad k_1 = hf(x_n, y_n, z_n)$$

$$k_2 = hf\left(x_n + \frac{1}{2}h, y_n + \frac{1}{2}k_1, z_n + \frac{1}{2}K_1\right)$$

$$k_3 = hf\left(x_n + \frac{1}{2}h, y_n + \frac{1}{2}k_2, z_n + \frac{1}{2}K_2\right)$$

$$k_4 = hf(x_n + h, y_n + k_3, z_n + K_3)$$

and

$$\begin{aligned}
 20. \quad K_1 &= hg(x_n, y_n, z_n) \\
 K_2 &= hg\left(x_n + \frac{1}{2}h, y_n + \frac{1}{2}k_1, z_n + \frac{1}{2}K_1\right) \\
 K_3 &= hg\left(x_n + \frac{1}{2}h, y_n + \frac{1}{2}k_2, z_n + \frac{1}{2}K_2\right) \\
 K_4 &= hg(x_n + h, y_n + k_3, z_n + K_3).
 \end{aligned}$$

As with the Runge–Kutta method, the local error involved in the determination of y_{n+1} from y_n and z_{n+1} from z_n is $O(h^5)$.

This method may also be used to solve the second-order equation

$$21. \quad \frac{d^2y}{dx^2} = H\left(x, y, \frac{dy}{dx}\right)$$

subject to the initial conditions

$$22. \quad y(x_0) = a \quad \text{and} \quad y'(x_0) = b,$$

by setting $z = dy/dx$ and replacing the second-order equation by the system

$$23. \quad \frac{dy}{dx} = z$$

$$24. \quad \frac{dz}{dx} = H(x, y, z),$$

subject to the initial conditions

$$25. \quad y(x_0) = a, \quad z(x_0) = b.$$

Runge–Kutta–Fehlberg Method. The **Runge–Kutta–Fehlberg** (R–K–F) method is an adaptive technique that uses a Runge–Kutta method with a local error of order 5 in order to estimate the local error in the Runge–Kutta method of order 4. The result is then used to adjust the step length h so the magnitude of the global error is bounded by some given tolerance ε . In general, the step length is changed after each step, but high accuracy is attained if ε is taken to be suitably small, though this may be at the expense of (many) extra steps in the calculation. Because of the computation involved, the method is only suitable for implementation on a computer, though the calculation is efficient because only six evaluations of the $f(x, y)$ are required at each step compared with the four required for the Runge–Kutta method of order 4.

The R–K–F algorithm for the determination of the approximation \tilde{y}_{n+1} to $y(x_{n+1})$ is as follows: It is necessary to obtain a numerical solution to the initial value problem

$$26. \quad \frac{dy}{dx} = f(x, y),$$

subject to the initial condition

$$27. \quad y(x_0) = y_0,$$

in which the magnitude of the global error is to be bounded by a given tolerance ϵ .

The approximation \tilde{y}_{n+1} to $y(x_{n+1})$ is given by

$$28. \quad \tilde{y}_{n+1} = y_n = \frac{16}{135}k_1 + \frac{6656}{12825}k_3 + \frac{28561}{56430}k_4 - \frac{9}{50}k_5 + \frac{2}{55}k_6,$$

where y_{n+1} used in the determination of the step length is

$$29. \quad y_{n+1} = y_n + \frac{25}{216}k_1 + \frac{1408}{2565}k_3 + \frac{2197}{4104}k_4 - \frac{1}{5}k_5$$

and

$$30. \quad k_1 = hf(x_n, y_n)$$

$$k_2 = hf\left(x_n + \frac{1}{4}h, y_n + \frac{1}{4}k_1\right)$$

$$k_3 = hf\left(x_n + \frac{3}{8}h, y_n + \frac{3}{32}k_1 + \frac{9}{32}k_2\right)$$

$$k_4 = hf\left(x_n + \frac{12}{13}h, y_n + \frac{1932}{2197}k_1 - \frac{7200}{2197}k_2 + \frac{7296}{2197}k_3\right)$$

$$k_5 = hf\left(x_n + h, y_n + \frac{439}{216}k_1 - 8k_2 + \frac{3680}{513}k_3 - \frac{845}{4104}k_4\right)$$

$$k_6 = hf\left(x_n + \frac{1}{2}h, y_n - \frac{8}{27}k_1 + 2k_2 - \frac{3544}{2565}k_3 + \frac{1859}{4104}k_4 - \frac{11}{40}k_5\right).$$

The factor μ by which the new step length μh is to be determined so that the global error bound ϵ is maintained is usually taken to be given

$$31. \quad \mu = 0.84 \left(\frac{\epsilon h}{|\tilde{y}_{n+1} - y_{n+1}|} \right)^{1/4}.$$

The relative accuracy of these methods is illustrated by their application to the following two examples.

Example 22.20 Solve the initial value problem

$$x \frac{dy}{dx} = -6y + 3xy^{4/3},$$

subject to the initial condition $y(1) = 2$.

After division by x , the differential equation is seen to be a Bernoulli equation, and a routine calculation shows its solution to be

$$y = \left[x + x^2 \left(\frac{1}{2} 2^{2/3} - 1 \right) \right]^{-3}.$$

The numerical solutions obtained by the methods described above are as follows:

x_n	$\langle y_n \rangle$				
	Euler	Modified Euler	R-K	R-K-F	Exact
1.0	2	2	2	2	2
1.1	1.555953	1.624075	1.626173	1.626165	1.626165
1.2	1.24815	1.354976	1.358449	1.358437	1.358437
1.3	1.027235	1.156977	1.161392	1.161378	1.161378
1.4	0.86407	1.008072	1.013169	1.013155	1.013155
1.5	0.740653	0.894173	0.899801	0.899786	0.899786
1.6	0.645428	0.805964	0.812040	0.812025	0.812025
1.7	0.570727	0.737119	0.743608	0.743593	0.743593
1.8	0.511317	0.683251	0.690149	0.690133	0.690133
1.9	0.46354	0.641264	0.648593	0.648578	0.648578
2.0	0.424781	0.608957	0.616762	0.616745	0.616745

Example 22.21 Solve Bessel's equation

$$x^2 \frac{d^2 y}{dx^2} + x \frac{dy}{dx} + (x^2 - n^2) y = 0$$

in the interval $1 \leq x \leq 5$ for the case $n = 0$, subject to the initial conditions $y(1) = 1$ and $y'(1) = 0$.

This has the analytical solution

$$y(x) = \frac{Y_1(1)J_0(x)}{J_0(1)Y_1(1) - J_1(1)Y_0(1)} - \frac{J_1(1)Y_0(x)}{J_0(1)Y_1(1) - J_1(1)Y_0(1)}.$$

The numerical results obtained by the Runge–Kutta method with a uniform step length $h = 0.4$ are shown in the second column of the following table, while the third and fourth columns show the results obtained by the R–K–F method with $\epsilon = 10^{-6}$ and the exact result,

respectively. It is seen that in the interval $1 \leq x \leq 5$, the R–K–F method and the exact result agree to six decimal places.

x_n	$\langle y_n \rangle$		
	R–K	R–K–F	Exact
1.0	1	1.000000	1.000000
1.4	0.929215	0.929166	0.929166
1.8	0.74732	0.747221	0.747221
2.2	0.495544	0.495410	0.495410
2.6	0.214064	0.213918	0.213918
3.0	-0.058502	-0.058627	-0.058627
3.4	-0.288252	-0.288320	-0.288320
3.8	-0.449422	-0.449401	-0.449401
4.2	-0.527017	-0.526887	-0.526887
4.6	-0.518105	-0.517861	-0.517861
5.0	-0.431532	-0.431190	-0.431190

Two-point boundary value problems—the shooting method. A two-point boundary value problem for the second-order equation,

$$32. \quad \frac{d^2y}{dx^2} = f(x, y, y') \quad [a \leq x \leq b],$$

which may be either linear or nonlinear, involves finding the solution $y(x)$ that satisfies the **boundary conditions**

$$33. \quad y(a) = \alpha \quad \text{and} \quad y(b) = \beta$$

at the end points of the interval $a \leq x \leq b$. Numerical methods for solving *initial value problems* for second-order equations cannot be used to solve this problem directly, because instead of specifying y and y' at an initial point $x = a$, y alone is specified at two distinct points $x = a$ and $x = b$.

To understand the **shooting method** used to solve 22.18.1.31 subject to the boundary conditions of 22.18.1.32, let us suppose that one of the methods for solving initial value problems, say, the Runge–Kutta method, is applied twice to the equation with two slightly different sets of initial conditions. Specifically, suppose the *same* initial condition $y(a) = \alpha$ is used in each case, but that two *different* initial gradients $y'(a)$ are used, so that

$$(I) \quad y(a) = \alpha \quad \text{and} \quad y'(a) = \gamma$$

and

$$(II) \quad y(a) = \alpha \quad \text{and} \quad y'(a) = \delta,$$

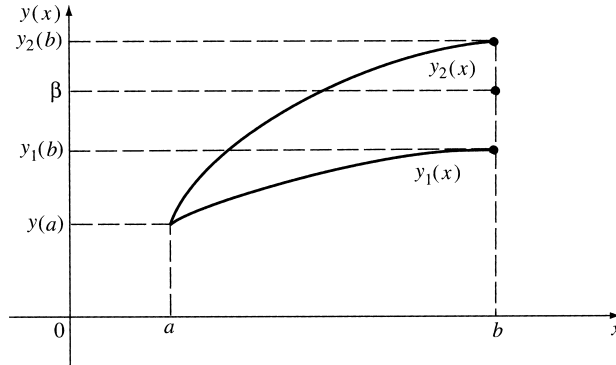

Figure 22.1.

where $\gamma \neq \delta$ are chosen arbitrarily. Let the two different solutions $y_1(x)$ and $y_2(x)$ correspond, respectively, to the initial conditions (I) and (II). Typical solutions are illustrated in Figure 22.1, in which $y_1(b)$ and $y_2(b)$ differ from the required result $y(b) \equiv \beta$.

The approach used to obtain the desired solution is called the *shooting method* because if each solution curve is considered as the trajectory of a particle shot from the point $x = a$ at the elevation $y(a) = \alpha$, provided there is a unique solution, the required terminal value $y(b) = \beta$ will be attained when the trajectory starts with the correct gradient $y'(a)$.

When 22.18.1.31 is a linear equation, and so can be written

$$34. \quad y'' = p(x)y' + q(x)y + r(x) \quad [a \leq x \leq b],$$

the appropriate choice for $y'(a)$ is easily determined. Setting

$$35. \quad y(x) = k_1 y_1(x) + k_2 y_2(x),$$

with

$$36. \quad k_1 + k_2 = 1,$$

and substituting into 22.18.1.35 leads to the result

$$37. \quad \frac{d^2}{dx^2} (k_1 y_1 + k_2 y_2) = p(x) \frac{d}{dx} (k_1 y_1 + k_2 y_2) + q(x)(k_1 y_1 + k_2 y_2) + r(x),$$

which shows that $y(x) = k_1 y_1(x) + k_2 y_2(x)$ is itself a solution. Furthermore, $y(x) = k_1 y_1(x) + k_2 y_2(x)$ satisfies the left-hand boundary condition $y(a) = \alpha$.

Setting $x = b, y(b) = \beta$ in 22.18.1.35 gives

$$\beta = k_1 y_1(b) + k_2 y_2(b),$$

which can be solved in conjunction with $k_1 + k_2 = 1$ to give

$$38. \quad k_1 = \frac{\beta - y_2(b)}{y_1(b) - y_2(b)} \quad \text{and} \quad k_2 = 1 - k_1.$$

The solution is then seen to be given by

$$39. \quad y(x) = \left[\frac{\beta - y_2(b)}{y_1(b) - y_2(b)} \right] y_1(x) + \left[\frac{y_1(b) - \beta}{y_1(b) - y_2(b)} \right] y_2(x) \quad [a \leq x \leq b].$$

A variant of this method involves starting from the two quite different initial value problems; namely, the original equation

$$40. \quad y'' = p(x)y' + q(x)y + r(x),$$

with the initial conditions

$$(III) \quad y(a) = \alpha \quad \text{and} \quad y'(a) = 0$$

and the corresponding *homogeneous* equation

$$41. \quad y'' = p(x)y' + q(x)y,$$

with the initial conditions

$$(IV) \quad y(a) = 0 \quad \text{and} \quad y'(a) = 1.$$

Using the fact that adding to the solution of the homogeneous equation any solution of the inhomogeneous equation will give rise to the general solution of the inhomogeneous equation, a similar form of argument to the one used above shows the required solution to be given by

$$42. \quad y(x) = y_3(x) + \left[\frac{\beta - y_3(b)}{y_4(b)} \right] y_4(x),$$

where $y_3(x)$ and $y_4(x)$ are, respectively, the solutions of 22.18.1.40 with boundary conditions (III) and 22.18.1.41 with boundary conditions (IV).

The method must be modified when 22.18.1.31 is **nonlinear**, because solutions of homogeneous equations are no longer additive. It then becomes necessary to use an iterative method to adjust repeated estimates of $y'(a)$ until the terminal value $y(b) = \beta$ is attained to the required accuracy.

We mention only the iterative approach based on the *secant method* of interpolation, because this is the simplest to implement. Let the two-point boundary value problem be

$$43. \quad y'' = f(x, y, y') \quad [a \leq x \leq b],$$

subject to the boundary conditions

$$44. \quad y(a) = \alpha \quad \text{and} \quad y(b) = \beta.$$

Let k_0 and k_1 be two estimates of the initial gradient $y'(a)$, and denote the solution of

$$y'' = f(x, y, y'), \quad \text{with } y(a) = \alpha \quad \text{and} \quad y'(a) = k_0,$$

by $y_0(x)$, and the solution of

$$y'' = f(x, y, y'), \quad \text{with } y(a) = \alpha \quad \text{and} \quad y'(a) = k_1,$$

by $y_1(x)$.

The iteration then proceeds using successive values of the gradient k_i , for $i = 2, 3, \dots$, and the corresponding terminal values $y_i(b)$, in the scheme

$$k_i = k_{i-1} - \frac{(y_{i-1}(b) - \beta)(k_{i-1} - k_{i-2})}{y_{i-1}(b) - y_{i-2}(b)},$$

starting from k_0 and k_1 , until for some $i = N$, $|y_N(b) - y_{N-1}(b)| < \varepsilon$, where ε is a preassigned tolerance. The required approximate solution is then given by $y_N(x)$, for $a \leq x \leq b$.

In particular, it is usually necessary to experiment with the initial estimates k_0 and k_1 to ensure the convergence of the iterative scheme.

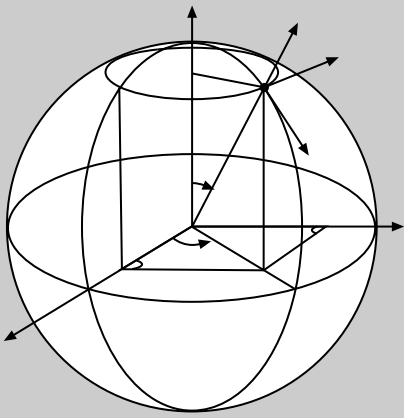

Chapter 23

Vector Analysis

23.1 SCALARS AND VECTORS

23.1.1 Basic Definitions

23.1.1.1

A **scalar** quantity is completely defined by a single real number (positive or negative) that measures its *magnitude*. Examples of scalars are length, mass, temperature, and electric potential. In print, scalars are represented by Roman or Greek letters like r, m, T , and ϕ .

A **vector** quantity is defined by giving its *magnitude* (a nonnegative scalar), and its *line of action* (a line in space) together with its **sense** (direction) along the line. Examples of vectors are velocity, acceleration, angular velocity, and electric field. In print, vector quantities are represented by Roman and Greek boldface letters like \mathbf{v} , \mathbf{a} , $\mathbf{\Omega}$, and \mathbf{E} . By convention, the magnitudes of vectors \mathbf{v} , \mathbf{a} , and $\mathbf{\Omega}$ are usually represented by the corresponding ordinary letters v , a , and Ω , etc. The magnitude of a vector \mathbf{r} is also denoted by $|\mathbf{r}|$, so that

1. $r = |\mathbf{r}|$.

A vector of unit magnitude in the direction of \mathbf{r} , called a **unit vector**, is denoted by \mathbf{e}_r , so that

2. $\mathbf{r} = r\mathbf{e}_r$.

The **null vector (zero vector)** $\mathbf{0}$ is a vector with zero magnitude and no direction.

A geometrical interpretation of a vector is obtained by using a straight-line segment parallel to the line of action of the vector, whose length is equal (or proportional) to the magnitude of the vector, with the sense of the vector being indicated by an arrow along the line segment.

The end of the line segment from which the arrow is directed is called the **initial point** of the vector, while the other end (toward which the arrow is directed) is called the **terminal point** of the vector.

A **right-handed system** of rectangular cartesian coordinate axes $0\{x, y, z\}$ is one in which the positive direction along the z -axis is determined by the direction in which a right-handed screw advances when rotated from the x - to the y -axis. In such a system the signed lengths of the projections of a vector \mathbf{r} with initial point $P(x_0, y_0, z_0)$ and terminal point $Q(x_1, y_1, z_1)$ onto the x -, y -, and z -axes are called the x -, y -, and z **components** of the vector. Thus the x -, y -, and z components of \mathbf{r} directed from P to Q are $x_1 - x_0$, $y_1 - y_0$, and $z_1 - z_0$, respectively (Figure 23.1(a)). A vector directed from the origin 0 to the point $P(x_0, y_0, z_0)$ has x_0 , y_0 , and z_0 as its respective x -, y -, and z components [Figure 23.1(b)]. Special unit vectors directed along the x -, y -, and z -axes are denoted by \mathbf{i} , \mathbf{j} , and \mathbf{k} , respectively.

The cosines of the angles α , β , and γ between \mathbf{r} and the respective x -, y -, and z -axes shown in Figure 23.2 are called the **direction cosines** of the vector \mathbf{r} . If the components of \mathbf{r} are x -, y -, and z -, then the respective direction cosines of \mathbf{r} , denoted by l , m , and n , are

$$3. \quad l = \frac{x}{r}, \quad m = \frac{y}{r}, \quad n = \frac{z}{r} \quad \text{with } r = (x^2 + y^2 + z^2)^{1/2}.$$

The direction cosines are related by

$$4. \quad l^2 + m^2 + n^2 = 1.$$

Numbers u , v , and w proportional to l , m , and n , respectively, are called **direction ratios**.

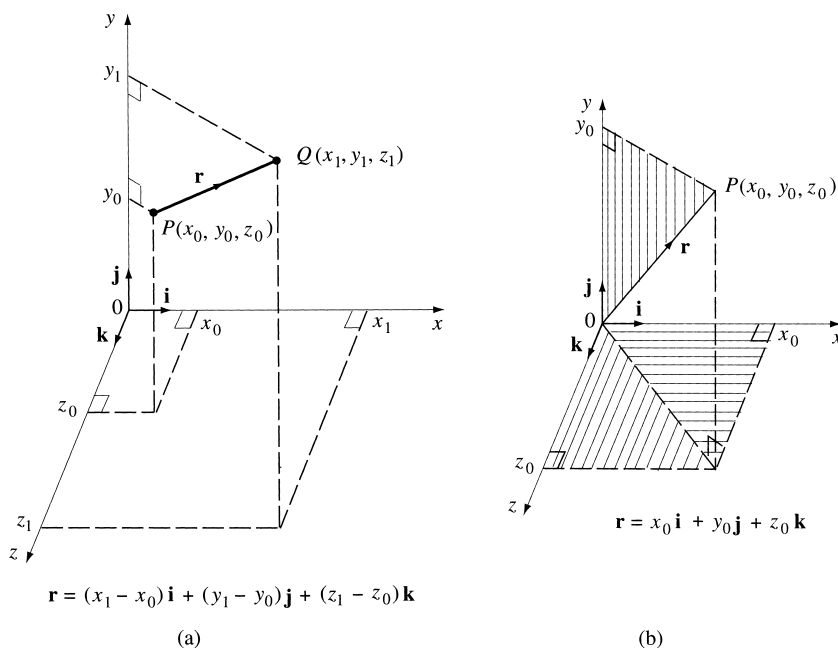

Figure 23.1.

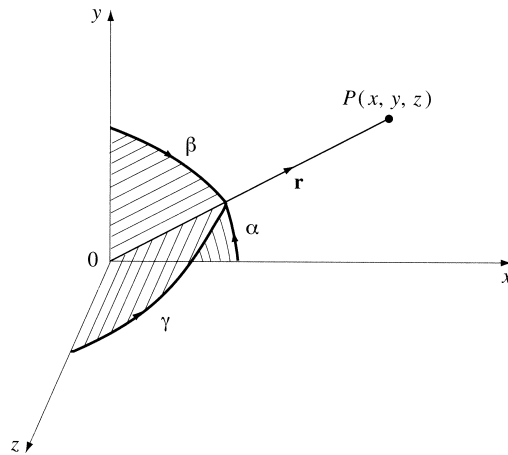

Figure 23.2.

23.1.2 Vector Addition and Subtraction

23.1.2.1

Vector addition of vectors \mathbf{a} and \mathbf{b} , denoted by $\mathbf{a} + \mathbf{b}$, is performed by first translating vector \mathbf{b} , without rotation, so that its initial point coincides with the terminal point of \mathbf{a} . The vector sum $\mathbf{a} + \mathbf{b}$ is then defined as the vector whose initial point is the initial point of \mathbf{a} , and whose terminal point is the new terminal point of \mathbf{b} (the **triangle rule** for vector addition) (Figure 23.3(a)).

The **negative** of vector \mathbf{c} , denoted by $-\mathbf{c}$, is obtained from \mathbf{c} by reversing its sense, as in Figure 23.3(b), and so

1. $c = |\mathbf{c}| = |-\mathbf{c}|$.

The **difference** $\mathbf{a} - \mathbf{b}$ of vectors \mathbf{a} and \mathbf{b} is defined as the vector sum $\mathbf{a} + (-\mathbf{b})$. This corresponds geometrically to translating vector $-\mathbf{b}$, without rotation, until its initial point coincides with the terminal point of \mathbf{a} , when the vector $\mathbf{a} - \mathbf{b}$ is the vector drawn from the initial point of \mathbf{a} to the new terminal point of $-\mathbf{b}$ (Figure 23.4(a)). Equivalently, $\mathbf{a} - \mathbf{b}$ is obtained by bringing into coincidence the initial points of \mathbf{a} and \mathbf{b} and defining $\mathbf{a} - \mathbf{b}$ as the vector drawn from the terminal point of \mathbf{b} to the terminal point of \mathbf{a} [Figure 23.4(b)].

Vector addition obeys the following algebraic rules:

2. $\mathbf{a} + (-\mathbf{a}) = \mathbf{a} - \mathbf{a} = \mathbf{0}$

3. $\mathbf{a} + \mathbf{b} + \mathbf{c} = \mathbf{a} + \mathbf{c} + \mathbf{b} = \mathbf{b} + \mathbf{c} + \mathbf{a}$ (commutative law)

4. $(\mathbf{a} + \mathbf{b}) + \mathbf{c} = \mathbf{a} + (\mathbf{b} + \mathbf{c})$ (associative law)

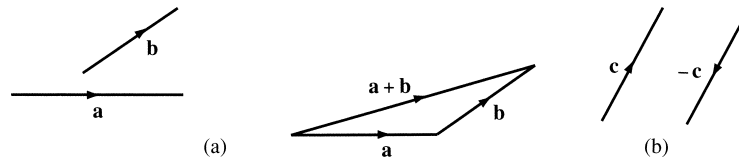

Figure 23.3.

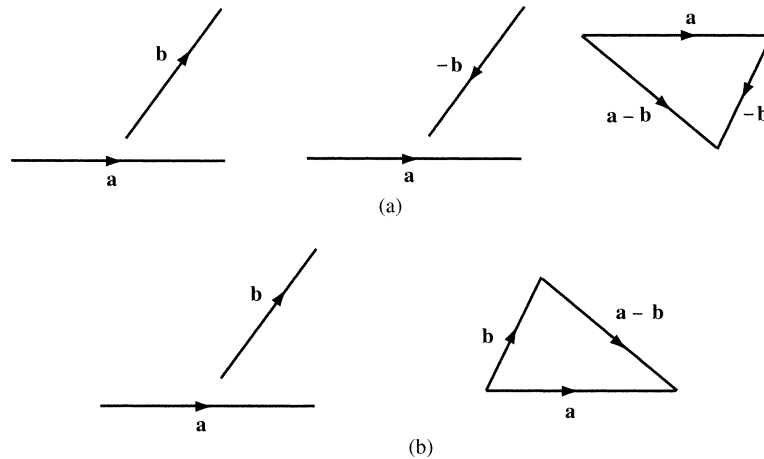

Figure 23.4.

The geometrical interpretations of laws 3 and 4 are illustrated in Figures 23.5(a) and 23.5(b).

23.1.3 Scaling Vectors

23.1.3.1

A vector \mathbf{a} may be **scaled** by the scalar λ to obtain the new vector $\mathbf{b} = \lambda\mathbf{a}$. The magnitude $b = |\mathbf{b}| = |\lambda\mathbf{a}| = |\lambda|a$. The sense of \mathbf{b} is the same as that of \mathbf{a} if $\lambda > 0$, but it is *reversed* if $\lambda < 0$. The scaling operation performed on vectors obeys the laws:

1. $\lambda\mathbf{a} = \mathbf{a}\lambda$ (commutative law)
2. $(\lambda + \mu)\mathbf{a} = \lambda\mathbf{a} + \mu\mathbf{a}$ (distributive law)
3. $\lambda(\mu\mathbf{a}) = \mu(\lambda\mathbf{a}) = (\lambda\mu)\mathbf{a}$ (associative law)
4. $\lambda(\mathbf{a} + \mathbf{b}) = \lambda\mathbf{a} + \lambda\mathbf{b}$ (distributive law)

where λ, μ are scalars and \mathbf{a}, \mathbf{b} are vectors.

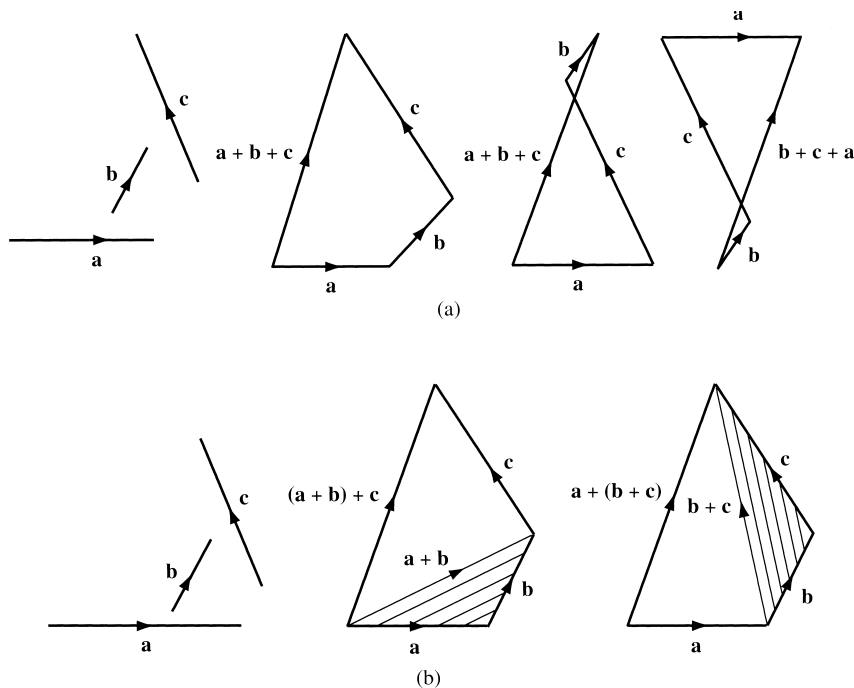

Figure 23.5.

23.1.4 Vectors in Component Form

23.1.4.1

If \mathbf{a} , \mathbf{b} , and \mathbf{c} are any three noncoplanar vectors, an arbitrary vector \mathbf{r} may always be written in the form

$$1. \quad \mathbf{r} = \lambda_1 \mathbf{a} + \lambda_2 \mathbf{b} + \lambda_3 \mathbf{c},$$

where the scalars λ_1 , λ_2 , and λ_3 are the components of \mathbf{r} in the **triad** of reference vectors \mathbf{a} , \mathbf{b} , \mathbf{c} . In the important special case of rectangular Cartesian coordinates $0\{x, y, z\}$, with unit vectors \mathbf{i} , \mathbf{j} , and \mathbf{k} along the x -, y -, and z -axes, respectively, the vector \mathbf{r} drawn from point $P(x_0, y_0, z_0)$ to point $Q(x_1, y_1, z_1)$ can be written (Figure 23.1(a))

$$2. \quad \mathbf{r} = (x_1 - x_0)\mathbf{i} + (y_1 - y_0)\mathbf{j} + (z_1 - z_0)\mathbf{k}.$$

Similarly, the vector drawn from the origin to the point $P(x_0, y_0, z_0)$ becomes (Figure 23.1(b))

$$3. \quad \mathbf{r} = x_0\mathbf{i} + y_0\mathbf{j} + z_0\mathbf{k}.$$

For 23.1.4.1.2 the magnitude of \mathbf{r} is

$$4. \quad r = |\mathbf{r}| = \left[(x_1 - x_0)^2 + (y_1 - y_0)^2 + (z_1 - z_0)^2 \right]^{1/2},$$

whereas for 23.1.4.1.3 the magnitude of \mathbf{r} is

$$r = |\mathbf{r}| = (x_0^2 + y_0^2 + z_0^2)^{1/2}.$$

In terms of the direction cosines l, m, n (see 23.1.1.1.3) the vector $\mathbf{r} = x\mathbf{i} + y\mathbf{j} + z\mathbf{k}$ becomes

$$\mathbf{r} = r(l\mathbf{i} + m\mathbf{j} + n\mathbf{k}),$$

where $l\mathbf{i} + m\mathbf{j} + n\mathbf{k}$ is the unit vector in the direction of \mathbf{r} .

If $\mathbf{a} = a_1\mathbf{i} + a_2\mathbf{j} + a_3\mathbf{k}$, $\mathbf{b} = b_1\mathbf{i} + b_2\mathbf{j} + b_3\mathbf{k}$, and λ and μ are scalars, then

$$5. \quad \lambda\mathbf{a} = \lambda a_1\mathbf{i} + \lambda a_2\mathbf{j} + \lambda a_3\mathbf{k},$$

$$6. \quad \mathbf{a} + \mathbf{b} = (a_1 + b_1)\mathbf{i} + (a_2 + b_2)\mathbf{j} + (a_3 + b_3)\mathbf{k},$$

$$7. \quad \lambda\mathbf{a} + \mu\mathbf{b} = (\lambda a_1 + \mu b_1)\mathbf{i} + (\lambda a_2 + \mu b_2)\mathbf{j} + (\lambda a_3 + \mu b_3)\mathbf{k},$$

which are equivalent to the results in 23.1.3.

23.2 SCALAR PRODUCTS

23.2.1

The **scalar product** (**dot product** or **inner product**) of vectors $\mathbf{a} = a_1\mathbf{i} + a_2\mathbf{j} + a_3\mathbf{k}$ and $\mathbf{b} = b_1\mathbf{i} + b_2\mathbf{j} + b_3\mathbf{k}$ inclined at an angle θ to one another and written $\mathbf{a} \cdot \mathbf{b}$ is defined as the scalar (Figure 23.6)

$$\begin{aligned} 1. \quad \mathbf{a} \cdot \mathbf{b} &= |\mathbf{a}| |\mathbf{b}| \cos \theta \\ &= ab \cos \theta \\ &= a_1 b_1 + a_2 b_2 + a_3 b_3. \end{aligned}$$

If required, the angle between \mathbf{a} and \mathbf{b} may be obtained from

$$2. \quad \cos \theta = \frac{\mathbf{a} \cdot \mathbf{b}}{|\mathbf{a}| |\mathbf{b}|} = \frac{a_1 b_1 + a_2 b_2 + a_3 b_3}{(a_1^2 + a_2^2 + a_3^2)^{1/2} (b_1^2 + b_2^2 + b_3^2)^{1/2}}.$$

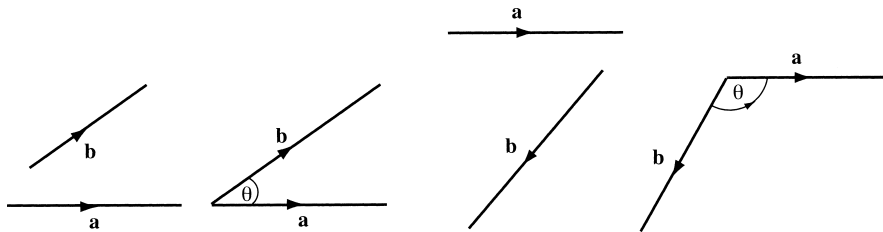

Figure 23.6.

Properties of the scalar product. If \mathbf{a} and \mathbf{b} are vectors and λ and μ are scalars, then:

3. $\mathbf{a} \cdot \mathbf{b} = \mathbf{b} \cdot \mathbf{a}$ (commutative property)
4. $(\lambda \mathbf{a}) \cdot (\mu \mathbf{b}) = \lambda \mu \mathbf{a} \cdot \mathbf{b}$ (associative property)
5. $\mathbf{a} \cdot (\mathbf{b} + \mathbf{c}) = \mathbf{a} \cdot \mathbf{b} + \mathbf{a} \cdot \mathbf{c}$ (distributive property)

Special cases

6. $\mathbf{a} \cdot \mathbf{b} = 0$ if \mathbf{a} , \mathbf{b} are orthogonal ($\theta = \pi/2$)
7. $\mathbf{a} \cdot \mathbf{b} = |\mathbf{a}| |\mathbf{b}| = ab$ if \mathbf{a} and \mathbf{b} are parallel ($\theta = 0$)
8. $\mathbf{i} \cdot \mathbf{i} = \mathbf{j} \cdot \mathbf{j} = \mathbf{k} \cdot \mathbf{k} = 1$ and $\mathbf{i} \cdot \mathbf{j} = \mathbf{j} \cdot \mathbf{k} = \mathbf{k} \cdot \mathbf{i} = 0$.

23.3 VECTOR PRODUCTS

23.3.1

The **vector product (cross product)** of vectors $\mathbf{a} = a_1\mathbf{i} + a_2\mathbf{j} + a_3\mathbf{k}$ and $\mathbf{b} = b_1\mathbf{i} + b_2\mathbf{j} + b_3\mathbf{k}$ inclined at an angle θ to one another and written $\mathbf{a} \times \mathbf{b}$ is defined as the vector

$$1. \quad \mathbf{a} \times \mathbf{b} = |\mathbf{a}| |\mathbf{b}| \sin \theta \mathbf{n} = ab \sin \theta \mathbf{n},$$

where \mathbf{n} is a unit vector normal to the plane containing \mathbf{a} and \mathbf{b} directed in the sense in which a right-handed screw would advance if rotated from \mathbf{a} to \mathbf{b} (Figure 23.7).

An alternative and more convenient definition of $\mathbf{a} \times \mathbf{b}$ is

$$2. \quad \mathbf{a} \times \mathbf{b} = \begin{vmatrix} \mathbf{i} & \mathbf{j} & \mathbf{k} \\ a_1 & a_2 & a_3 \\ b_1 & b_2 & b_3 \end{vmatrix}.$$

If required, the angle θ between \mathbf{a} and \mathbf{b} follows from

$$3. \quad \sin \theta = \frac{|\mathbf{a} \times \mathbf{b}|}{ab},$$

though the result 23.2.1.2 is usually easier to use.

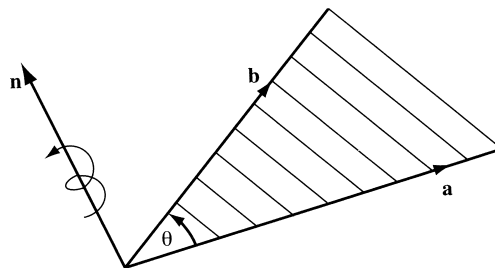

Figure 23.7.

Properties of the vector product. If \mathbf{a} and \mathbf{b} are vectors and λ and μ are scalars, then

4. $\mathbf{a} \times \mathbf{b} = -\mathbf{a} \times \mathbf{b}$ (noncommutative)
5. $(\lambda\mathbf{a}) \times (\mu\mathbf{b}) = \lambda\mu \mathbf{a} \times \mathbf{b}$ (associative property)
6. $\mathbf{a} \times (\mathbf{b} + \mathbf{c}) = \mathbf{a} \times \mathbf{b} + \mathbf{a} \times \mathbf{c}$ (distributive property)

Special cases

7. $\mathbf{a} \times \mathbf{b} = \mathbf{0}$ if \mathbf{a} and \mathbf{b} are parallel ($\theta = 0$)
8. $\mathbf{a} \times \mathbf{b} = ab\mathbf{n}$ if \mathbf{a} and \mathbf{b} are orthogonal ($\theta = \pi/2$) (\mathbf{n} the unit normal)
9. $\mathbf{i} \times \mathbf{j} = \mathbf{k}$, $\mathbf{j} \times \mathbf{k} = \mathbf{i}$, $\mathbf{k} \times \mathbf{i} = \mathbf{j}$
10. $\mathbf{i} \times \mathbf{i} = \mathbf{j} \times \mathbf{j} = \mathbf{k} \times \mathbf{k} = \mathbf{0}$

23.4 TRIPLE PRODUCTS

23.4.1

The **scalar triple product** of the three vectors $\mathbf{a} = a_1\mathbf{i} + a_2\mathbf{j} + a_3\mathbf{k}$, $\mathbf{b} = b_1\mathbf{i} + b_2\mathbf{j} + b_3\mathbf{k}$, and $\mathbf{c} = c_1\mathbf{i} + c_2\mathbf{j} + c_3\mathbf{k}$, written $\mathbf{a} \cdot (\mathbf{b} \times \mathbf{c})$, is the scalar

$$1. \quad \mathbf{a} \cdot (\mathbf{b} \times \mathbf{c}) = \mathbf{b} \cdot (\mathbf{c} \times \mathbf{a}) = \mathbf{c} \cdot (\mathbf{a} \times \mathbf{b}).$$

In terms of components

$$2. \quad \mathbf{a} \cdot (\mathbf{b} \times \mathbf{c}) = \begin{vmatrix} a_1 & a_2 & a_3 \\ b_1 & b_2 & b_3 \\ c_1 & c_2 & c_3 \end{vmatrix}.$$

The alternative notation $[\mathbf{abc}]$ is also used for the scalar triple product in place of $\mathbf{a} \cdot (\mathbf{b} \times \mathbf{c})$.

In geometrical terms the absolute value of $\mathbf{a} \cdot (\mathbf{b} \times \mathbf{c})$ may be interpreted as the volume V of a parallelepiped in which \mathbf{a} , \mathbf{b} , and \mathbf{c} form three adjacent edges meeting at a corner (Figure 23.8). This interpretation provides a useful test for the linear independence of any three vectors. The vectors \mathbf{a} , \mathbf{b} , and \mathbf{c} are *linearly dependent* if $\mathbf{a} \cdot (\mathbf{b} \times \mathbf{c}) = 0$, because $V = 0$ implies that the vectors are coplanar, and so $\mathbf{a} = \lambda\mathbf{b} + \mu\mathbf{c}$ for some scalars λ and μ ; whereas they are *linearly independent* if $\mathbf{a} \cdot (\mathbf{b} \times \mathbf{c}) \neq 0$.

The **vector triple product** of the three vectors \mathbf{a} , \mathbf{b} , and \mathbf{c} , denoted by $\mathbf{a} \times (\mathbf{b} \times \mathbf{c})$, is given by

$$3. \quad \mathbf{a} \times (\mathbf{b} \times \mathbf{c}) = (\mathbf{a} \cdot \mathbf{c})\mathbf{b} - (\mathbf{a} \cdot \mathbf{b})\mathbf{c}.$$

The parentheses are essential in a vector triple product to avoid ambiguity, because $\mathbf{a} \times (\mathbf{b} \times \mathbf{c}) \neq (\mathbf{a} \times \mathbf{b}) \times \mathbf{c}$.

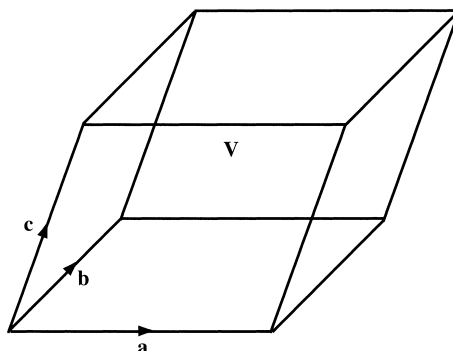

Figure 23.8.

23.5 PRODUCTS OF FOUR VECTORS

23.5.1

Two other products arise that involve the four vectors \mathbf{a} , \mathbf{b} , \mathbf{c} , and \mathbf{d} . The first is the *scalar product*

$$1. \quad (\mathbf{a} \times \mathbf{b}) \cdot (\mathbf{c} \times \mathbf{d}) = (\mathbf{a} \cdot \mathbf{c})(\mathbf{b} \cdot \mathbf{d}) - (\mathbf{a} \cdot \mathbf{d})(\mathbf{b} \cdot \mathbf{c}),$$

and the second is the *vector product*

$$2. \quad (\mathbf{a} \times \mathbf{b}) \times (\mathbf{c} \times \mathbf{d}) = \mathbf{a} \cdot (\mathbf{b} \times \mathbf{d}) \mathbf{c} - \mathbf{a} \cdot (\mathbf{b} \times \mathbf{c}) \mathbf{d}.$$

23.6 DERIVATIVES OF VECTOR FUNCTIONS OF A SCALAR t

23.6.1

Let $x(t)$, $y(t)$, and $z(t)$ be continuous functions of t that are differentiable as many times as necessary, and let \mathbf{i} , \mathbf{j} , and \mathbf{k} be the triad of fixed unit vectors introduced in 23.1.4. Then the vector $\mathbf{r}(t)$ given by

$$1. \quad \mathbf{r}(t) = x(t)\mathbf{i} + y(t)\mathbf{j} + z(t)\mathbf{k}$$

is a vector function of the scalar variable t that has the same continuity and differentiability properties as its components. The first- and second-order derivatives of $\mathbf{r}(t)$ with respect to t are

$$2. \quad \frac{d\mathbf{r}}{dt} = \dot{\mathbf{r}} = \frac{dx}{dt}\mathbf{i} + \frac{dy}{dt}\mathbf{j} + \frac{dz}{dt}\mathbf{k}$$

and

$$3. \quad \frac{d^2\mathbf{r}}{dt^2} = \ddot{\mathbf{r}} = \frac{d^2x}{dt^2}\mathbf{i} + \frac{d^2y}{dt^2}\mathbf{j} + \frac{d^2z}{dt^2}\mathbf{k}.$$

Higher order derivatives are defined in similar fashion so that, in general,

$$4. \quad \frac{d^n \mathbf{r}}{dt^n} = \frac{d^n x}{dt^n} \mathbf{i} + \frac{d^n y}{dt^n} \mathbf{j} + \frac{d^n z}{dt^n} \mathbf{k}.$$

If \mathbf{r} is the **position vector** of a point in space of time t , then $\dot{\mathbf{r}}$ is its *velocity* and $\ddot{\mathbf{r}}$ is its *acceleration* (Figure 23.9).

Differentiation of combinations of vector functions of a scalar t . Let \mathbf{u} and \mathbf{v} be continuous functions of the scalar variable t that are differentiable as many times as necessary, and let $\phi(t)$ be a scalar function of t with the same continuity and differentiability properties as the components of the vector functions. Then the following differentiability results hold:

1. $\frac{d}{dt}(\mathbf{u} + \mathbf{v}) = \frac{d\mathbf{u}}{dt} + \frac{d\mathbf{v}}{dt}$
2. $\frac{d}{dt}(\phi\mathbf{u}) = \frac{d\phi}{dt}\mathbf{u} + \phi\frac{d\mathbf{u}}{dt}$
3. $\frac{d}{dt}(\mathbf{u} \cdot \mathbf{v}) = \frac{d\mathbf{u}}{dt} \cdot \mathbf{v} + \mathbf{u} \cdot \frac{d\mathbf{v}}{dt}$
4. $\frac{d}{dt}(\phi\mathbf{u} \cdot \mathbf{v}) = \frac{d\phi}{dt}\mathbf{u} \cdot \mathbf{v} + \phi\frac{d\mathbf{u}}{dt} \cdot \mathbf{v} + \phi\mathbf{u} \cdot \frac{d\mathbf{v}}{dt}$
5. $\frac{d}{dt}(\mathbf{u} \times \mathbf{v}) = \frac{d\mathbf{u}}{dt} \times \mathbf{v} + \mathbf{u} \times \frac{d\mathbf{v}}{dt}$
6. $\frac{d}{dt}(\phi\mathbf{u} \times \mathbf{v}) = \frac{d\phi}{dt}\mathbf{u} \times \mathbf{v} + \phi\frac{d\mathbf{u}}{dt} \times \mathbf{v} + \phi\mathbf{u} \times \frac{d\mathbf{v}}{dt}$

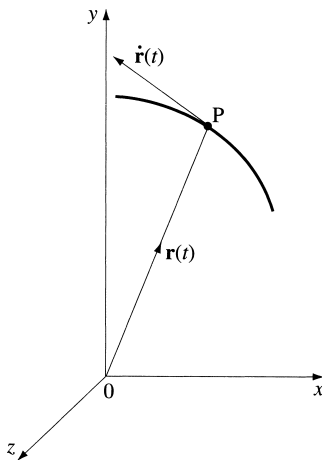

Figure 23.9.

23.7 DERIVATIVES OF VECTOR FUNCTIONS OF SEVERAL SCALAR VARIABLES

23.7.1

Let $u_i(x, y, z)$ and $v_i(x, y, z)$ for $i = 1, 2, 3$ be continuous functions of the scalar variables $x, y,$ and z , and let them have as many partial derivatives as necessary.

Define

$$1. \quad \mathbf{u}(x, y, z) = u_1\mathbf{i} + u_2\mathbf{j} + u_3\mathbf{k}$$

$$2. \quad \mathbf{v}(x, y, z) = v_1\mathbf{i} + v_2\mathbf{j} + v_3\mathbf{k},$$

where $\mathbf{i}, \mathbf{j},$ and \mathbf{k} are the triad of fixed unit vectors introduced in 23.1.4. Then the following differentiability results hold:

$$3. \quad \frac{\partial \mathbf{u}}{\partial x} = \frac{\partial u_1}{\partial x}\mathbf{i} + \frac{\partial u_2}{\partial x}\mathbf{j} + \frac{\partial u_3}{\partial x}\mathbf{k}$$

$$4. \quad \frac{\partial \mathbf{u}}{\partial y} = \frac{\partial u_1}{\partial y}\mathbf{i} + \frac{\partial u_2}{\partial y}\mathbf{j} + \frac{\partial u_3}{\partial y}\mathbf{k}$$

$$5. \quad \frac{\partial \mathbf{u}}{\partial z} = \frac{\partial u_1}{\partial z}\mathbf{i} + \frac{\partial u_2}{\partial z}\mathbf{j} + \frac{\partial u_3}{\partial z}\mathbf{k},$$

with corresponding results of $\partial \mathbf{v}/\partial x,$ $\partial \mathbf{v}/\partial y,$ and $\partial \mathbf{v}/\partial z.$

Second-order and higher derivatives of \mathbf{u} and \mathbf{v} are defined in the obvious manner:

$$6. \quad \frac{\partial^2 \mathbf{u}}{\partial x^2} = \frac{\partial}{\partial x} \left(\frac{\partial \mathbf{u}}{\partial x} \right), \quad \frac{\partial^2 \mathbf{u}}{\partial x \partial y} = \frac{\partial}{\partial x} \left(\frac{\partial \mathbf{u}}{\partial y} \right), \quad \frac{\partial^2 \mathbf{u}}{\partial x \partial z} = \frac{\partial}{\partial x} \left(\frac{\partial \mathbf{u}}{\partial z} \right), \dots$$

$$7. \quad \frac{\partial^3 \mathbf{u}}{\partial x^3} = \frac{\partial}{\partial x} \left(\frac{\partial^2 \mathbf{u}}{\partial x^2} \right), \quad \frac{\partial^3 \mathbf{u}}{\partial x^2 \partial y} = \frac{\partial}{\partial x} \left(\frac{\partial^2 \mathbf{u}}{\partial x \partial y} \right), \quad \frac{\partial^3 \mathbf{u}}{\partial x \partial z^2} = \frac{\partial}{\partial x} \left(\frac{\partial^2 \mathbf{u}}{\partial z^2} \right), \dots$$

$$8. \quad \frac{\partial}{\partial x} (\mathbf{u} \cdot \mathbf{v}) = \frac{\partial \mathbf{u}}{\partial x} \cdot \mathbf{v} + \mathbf{u} \cdot \frac{\partial \mathbf{v}}{\partial x}$$

$$9. \quad \frac{\partial}{\partial x} (\mathbf{u} \times \mathbf{v}) = \frac{\partial \mathbf{u}}{\partial x} \times \mathbf{v} + \mathbf{u} \times \frac{\partial \mathbf{v}}{\partial x},$$

with corresponding results for derivatives with respect to y and z and for higher order derivatives.

$$10. \quad d\mathbf{u} = \frac{\partial \mathbf{u}}{\partial x} dx + \frac{\partial \mathbf{u}}{\partial y} dy + \frac{\partial \mathbf{u}}{\partial z} dz \quad (\text{total differential})$$

and if $x = x(t)$, $y = y(t)$, $z = z(t)$,

$$11. \quad d\mathbf{u} = \left(\frac{\partial \mathbf{u}}{\partial x} \frac{dx}{dt} + \frac{\partial \mathbf{u}}{\partial y} \frac{dy}{dt} + \frac{\partial \mathbf{u}}{\partial z} \frac{dz}{dt} \right) dt \quad (\text{chain rule})$$

23.8 INTEGRALS OF VECTOR FUNCTIONS OF A SCALAR VARIABLE t

23.8.1

Let the vector function $f(t)$ of the scalar variable t be

$$1. \quad \mathbf{f}(t) = f_1(t)\mathbf{i} + f_2(t)\mathbf{j} + f_3(t)\mathbf{k},$$

where f_1 , f_2 , and f_3 are scalar functions of t for which a function $\mathbf{F}(t)$ exists such that

$$2. \quad \mathbf{f}(t) = \frac{d\mathbf{F}}{dt}.$$

Then

$$3. \quad \int \mathbf{f}(t) dt = \int \frac{d\mathbf{F}}{dt} dt = \mathbf{F}(t) + \mathbf{c},$$

where \mathbf{c} is an arbitrary vector constant. The function $\mathbf{F}(t)$ is called an **antiderivative** of $\mathbf{f}(t)$, and result 23.8.1.3 is called an **indefinite integral** of $\mathbf{f}(t)$. Expressed differently, 23.8.1.3 becomes

$$4. \quad \mathbf{F}(t) = \mathbf{i} \int f_1(t) dt + \mathbf{j} \int f_2(t) dt + \mathbf{k} \int f_3(t) dt + \mathbf{c}.$$

The **definite integral** of $f(t)$ between the scalar limits $t = t_1$ and $t = t_2$ is

$$5. \quad \int_{t_1}^{t_2} \mathbf{f}(t) dt = \mathbf{F}(t_2) - \mathbf{F}(t_1).$$

Properties of the definite integral. If λ is a scalar constant, t_3 is such that $t_1 < t_3 < t_2$, and $\mathbf{u}(t)$ and $\mathbf{v}(t)$ are vector functions of the scalar variable t , then

$$1. \quad \int_{t_1}^{t_2} \lambda \mathbf{u}(t) dt = \lambda \int_{t_1}^{t_2} \mathbf{u}(t) dt \quad (\text{homogeneity})$$

$$2. \quad \int_{t_1}^{t_2} [\mathbf{u}(t) + \mathbf{v}(t)] dt = \int_{t_1}^{t_2} \mathbf{u}(t) dt + \int_{t_1}^{t_2} \mathbf{v}(t) dt \quad (\text{linearity})$$

$$3. \quad \int_{t_1}^{t_2} \mathbf{u}(t) dt = - \int_{t_2}^{t_1} \mathbf{u}(t) dt \quad (\text{interchange of limits})$$

$$4. \int_{t_1}^{t_2} \mathbf{u}(t) dt = \int_{t_1}^{t_3} \mathbf{u}(t) dt + \int_{t_3}^{t_2} \mathbf{u}(t) dt \quad (\text{integration over contiguous intervals})$$

23.9 LINE INTEGRALS

23.9.1

Let \mathbf{F} be a continuous and differentiable vector function of position $P(x, y, z)$ in space, and let C be a **path (arc)** joining points $P_1(x_1, y_1, z_1)$ and $P_2(x_2, y_2, z_2)$. Then the **line integral** of \mathbf{F} taken along the path C from P_1 to P_2 is defined as (Figure 23.10)

$$1. \int_C \mathbf{F} \cdot d\mathbf{r} = \int_{P_1}^{P_2} \mathbf{F} \cdot d\mathbf{r} = \int_C (F_1 dx + F_2 dy + F_3 dz),$$

where

$$2. \mathbf{F} = F_1 \mathbf{i} + F_2 \mathbf{j} + F_3 \mathbf{k},$$

and

$$3. d\mathbf{r} = dx \mathbf{i} + dy \mathbf{j} + dz \mathbf{k}$$

is a differential vector displacement along the path C . It follows that

$$4. \int_{P_1}^{P_2} \mathbf{F} \cdot d\mathbf{r} = - \int_{P_2}^{P_1} \mathbf{F} \cdot d\mathbf{r},$$

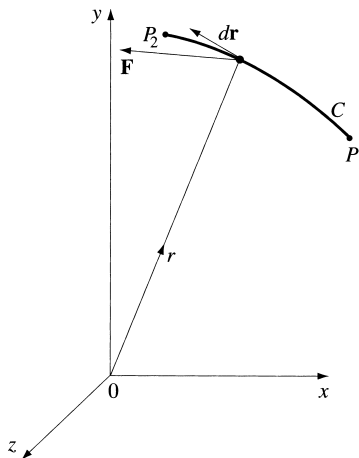

Figure 23.10.

while for three points P_1, P_2 and P_3 on C ,

$$5. \int_{P_1}^{P_2} \mathbf{F} \cdot d\mathbf{r} = \int_{P_1}^{P_3} \mathbf{F} \cdot d\mathbf{r} + \int_{P_3}^{P_2} \mathbf{F} \cdot d\mathbf{r}.$$

A special case of a line integral occurs when \mathbf{F} is given by

$$6. \mathbf{F} = \text{grad } \phi = \nabla \phi,$$

where in rectangular Cartesian coordinates

$$7. \text{grad } \phi = \mathbf{i} \frac{\partial \phi}{\partial x} + \mathbf{j} \frac{\partial \phi}{\partial y} + \mathbf{k} \frac{\partial \phi}{\partial z},$$

for

$$8. \int_C \mathbf{F} \cdot d\mathbf{r} = \int_{P_1}^{P_2} \mathbf{F} \cdot d\mathbf{r} = \phi(P_2) - \phi(P_1),$$

and the line integral is *independent* of the path C , depending only on the initial point P_1 and terminal point P_2 of C . A **vector field** of the form

$$9. \mathbf{F} = \text{grad } \phi$$

is called a **conservative field**, and ϕ is then called a **scalar potential**. For the definition of $\text{grad } \phi$ in terms of other coordinate systems see 24.2.1 and 24.3.1.

In a conservative field, if C is a *closed curve*, it then follows that

$$10. \int_C \mathbf{F} \cdot d\mathbf{r} = \oint_C \mathbf{F} \cdot d\mathbf{r} = 0,$$

where the symbol \oint indicates that the **curve** (contour) C is closed.

23.10 VECTOR INTEGRAL THEOREMS

23.10.1

Let a surface S defined by $z = f(x, y)$ that is bounded by a closed space curve C have an element of surface area $d\sigma$, and let \mathbf{n} be a unit vector normal to S at a representative point P (Figure 23.11).

Then the **vector element of surface area** $d\mathbf{S}$ of surface S is defined as

$$1. d\mathbf{S} = d\sigma \mathbf{n}.$$

The **surface integral** of a vector function $\mathbf{F}(x, y, z)$ over the surface S is defined as

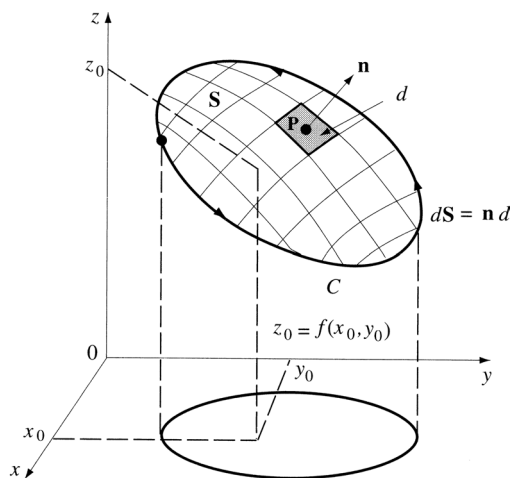

Figure 23.11.

$$2. \int_S \mathbf{F} \cdot d\mathbf{S} = \int_S \mathbf{F} \cdot \mathbf{n} \, d\sigma.$$

The **Gauss divergence theorem** states that if S is a closed surface containing a volume V with volume element dV , and if the vector element of surface area $d\mathbf{S} = \mathbf{n} \, d\sigma$, where \mathbf{n} is the unit normal directed out of V and $d\sigma$ is an element of surface area of S , then

$$3. \int_V \operatorname{div} \mathbf{F} \, dV = \int_S \mathbf{F} \cdot d\mathbf{S} = \int_S \mathbf{F} \cdot \mathbf{n} \, d\sigma.$$

The Gauss divergence theorem relates the volume integral of $\operatorname{div} \mathbf{F}$ to the surface integral of the normal component of \mathbf{F} over the closed surface S .

In terms of the rectangular Cartesian coordinates $0\{x, y, z\}$, the **divergence** of the vector $\mathbf{F} = F_1\mathbf{i} + F_2\mathbf{j} + F_3\mathbf{k}$, written $\operatorname{div} \mathbf{F}$, is defined as

$$4. \operatorname{div} \mathbf{F} = \frac{\partial F_1}{\partial x} + \frac{\partial F_2}{\partial y} + \frac{\partial F_3}{\partial z}.$$

For the definitions of $\operatorname{div} \mathbf{F}$ in terms of other coordinate systems see 24.2.1 and 24.3.1.

Stoke's theorem states that if C is a closed curve spanned by an open surface S , and \mathbf{F} is a vector function defined on S , then

$$5. \oint_C \mathbf{F} \cdot d\mathbf{r} = \int_S (\nabla \times \mathbf{F}) \cdot d\mathbf{S} = \int_S (\nabla \times \mathbf{F}) \cdot \mathbf{n} \, d\sigma.$$

In this theorem the direction of unit normal \mathbf{n} in the vector element of surface area $d\mathbf{S} = d\sigma \mathbf{n}$ is chosen such that it points in the direction in which a right-handed screw would advance

when rotated in the sense in which the closed curve C is traversed. A surface for which the normal is defined in this manner is called an **oriented surface**.

The surface S shown in Figure 23.11 is oriented in this manner when C is traversed in the direction shown by the arrows. In terms of rectangular Cartesian coordinates $0\{x, y, z\}$, the **curl** of the vector $\mathbf{F} = F_1\mathbf{i} + F_2\mathbf{j} + F_3\mathbf{k}$, written either $\nabla \times \mathbf{F}$, or $\text{curl } \mathbf{F}$, is defined as

$$\begin{aligned} 6. \quad \nabla \times \mathbf{F} &= \left(\mathbf{i} \frac{\partial}{\partial x} + \mathbf{j} \frac{\partial}{\partial y} + \mathbf{k} \frac{\partial}{\partial z} \right) \times \mathbf{F} \\ &= \left(\frac{\partial F_3}{\partial y} - \frac{\partial F_2}{\partial z} \right) \mathbf{i} + \left(\frac{\partial F_1}{\partial z} - \frac{\partial F_3}{\partial x} \right) \mathbf{j} + \left(\frac{\partial F_2}{\partial x} - \frac{\partial F_1}{\partial y} \right) \mathbf{k}. \end{aligned}$$

For the definition of $\nabla \times \mathbf{F}$ in terms of other coordinate systems see 24.2.1 and 24.3.1.

Green's first and second theorems (identities). Let U and V be scalar functions of position defined in a volume V contained within a simple closed surface S , with an outward-drawn vector element of surface area $d\mathbf{S}$. Suppose further that the **Laplacians** $\nabla^2 U$ and $\nabla^2 V$ are defined throughout V , except on a finite number of surfaces inside V , across which the second-order partial derivatives of U and V are bounded but discontinuous. **Green's first theorem** states that

$$7. \quad \int (U \nabla V) \cdot d\mathbf{S} = \int_V [U \nabla^2 V + (\nabla U) \cdot (\nabla V)] dV,$$

where in rectangular Cartesian coordinates

$$8. \quad \nabla^2 U = \frac{\partial^2 U}{\partial x^2} + \frac{\partial^2 U}{\partial y^2} + \frac{\partial^2 U}{\partial z^2}.$$

The Laplacian operator ∇^2 is also often denoted by Δ , or by Δ_n if it is necessary to specify the number n of space dimensions involved, so that in Cartesian coordinates $\Delta_2 U = \partial^2 U / \partial x^2 + \partial^2 U / \partial y^2$.

For the definition of the Laplacian in terms of other coordinate systems see 24.2.1 and 24.3.1.

Green's second theorem states that

$$9. \quad \int_V (U \nabla^2 V - V \nabla^2 U) dV = \int_S (U \nabla V - V \nabla U) \cdot d\mathbf{S}.$$

In two dimensions $0\{x, y\}$, **Green's theorem in the plane** takes the form

$$10. \quad \oint_C (P dx + Q dy) = \int_A \left(\frac{\partial Q}{\partial x} - \frac{\partial P}{\partial y} \right) dx dy,$$

where the scalar functions $P(x, y)$ and $Q(x, y)$ are defined and differentiable in some plane area A bounded by a simple closed curve C except, possibly, across an arc γ in A joining two distinct points of C , and the integration is performed counterclockwise around C .

23.11 A VECTOR RATE OF CHANGE THEOREM

Let u be a continuous and differentiable scalar function of position and time defined throughout a moving volume $V(t)$ bounded by a surface $S(t)$ moving with velocity \mathbf{v} . Then the rate of change of the volume integral of u is given by

$$1. \quad \frac{d}{dt} \int_{V(t)} u \, dV = \int_{V(t)} \left\{ \frac{\partial u}{\partial t} + \operatorname{div}(u\mathbf{v}) \right\} dV.$$

23.12 USEFUL VECTOR IDENTITIES AND RESULTS

23.12.1

In each identity that follows the result is expressed first in terms of grad, div, and curl, and then in operator notation. \mathbf{F} and \mathbf{G} are suitably differentiable vector functions and V and W are suitably differentiable scalar functions.

1. $\operatorname{div}(\operatorname{curl} \mathbf{F}) \equiv \nabla \cdot (\nabla \times \mathbf{F}) \equiv 0$
2. $\operatorname{curl}(\operatorname{grad} V) \equiv \nabla \times (\nabla V) \equiv \mathbf{0}$
3. $\operatorname{grad}(VW) \equiv V \operatorname{grad} W + W \operatorname{grad} V \equiv V\nabla W + W\nabla V$
4. $\operatorname{curl}(\operatorname{curl} \mathbf{F}) \equiv \operatorname{grad}(\operatorname{div} \mathbf{F}) - \nabla^2 \mathbf{F} \equiv \nabla(\nabla \cdot \mathbf{F}) - \nabla^2 \mathbf{F}$
5. $\operatorname{div}(\operatorname{grad} V) \equiv \nabla \cdot (\nabla V) \equiv \nabla^2 V$
6. $\operatorname{div}(V\mathbf{F}) \equiv V \operatorname{div} \mathbf{F} + \mathbf{F} \cdot \operatorname{grad} V \equiv \nabla \cdot (V\mathbf{F}) \equiv V\nabla \cdot \mathbf{F} + \mathbf{F} \cdot \nabla V$
7. $\operatorname{curl}(V\mathbf{F}) \equiv V \operatorname{curl} \mathbf{F} - \mathbf{F} \times \operatorname{grad} V \equiv V\nabla \times \mathbf{F} - \mathbf{F} \times \nabla V$
8. $\operatorname{grad}(\mathbf{F} \cdot \mathbf{G}) \equiv \mathbf{F} \times \operatorname{curl} \mathbf{G} + \mathbf{G} \times \operatorname{curl} \mathbf{F} + (\mathbf{F} \cdot \nabla)\mathbf{G} + (\mathbf{G} \cdot \nabla)\mathbf{F}$
 $\equiv \mathbf{F} \times (\nabla \times \mathbf{G}) + \mathbf{G} \times (\nabla \times \mathbf{F}) + (\mathbf{F} \cdot \nabla)\mathbf{G} + (\mathbf{G} \cdot \nabla)\mathbf{F}$
9. $\operatorname{div}(\mathbf{F} \times \mathbf{G}) \equiv \mathbf{G} \cdot \operatorname{curl} \mathbf{F} - \mathbf{F} \cdot \operatorname{curl} \mathbf{G} \equiv \mathbf{G} \cdot (\nabla \times \mathbf{F}) - \mathbf{F} \cdot (\nabla \times \mathbf{G})$
10. $\operatorname{curl}(\mathbf{F} \times \mathbf{G}) \equiv \mathbf{F} \operatorname{div} \mathbf{G} - \mathbf{G} \operatorname{div} \mathbf{F} + (\mathbf{G} \cdot \nabla)\mathbf{F} - (\mathbf{F} \cdot \nabla)\mathbf{G}$
 $\equiv \mathbf{F}(\nabla \cdot \mathbf{G}) - \mathbf{G}(\nabla \cdot \mathbf{F}) + (\mathbf{G} \cdot \nabla)\mathbf{F} - (\mathbf{F} \cdot \nabla)\mathbf{G}$
11. $\mathbf{F} \cdot \operatorname{grad} V = \mathbf{F} \cdot (\nabla V) = (\mathbf{F} \cdot \nabla)V$ is proportional to the *directional derivative* of V in the direction \mathbf{F} and it becomes the directional derivative of V in the direction \mathbf{F} when \mathbf{F} is a unit vector.
12. $\mathbf{F} \cdot \operatorname{grad} \mathbf{G} = (\mathbf{F} \cdot \nabla)\mathbf{G}$ is proportional to the directional derivative of \mathbf{G} in the direction of \mathbf{F} and it becomes the directional derivative of \mathbf{G} in the direction of \mathbf{F} when \mathbf{F} is a unit vector.

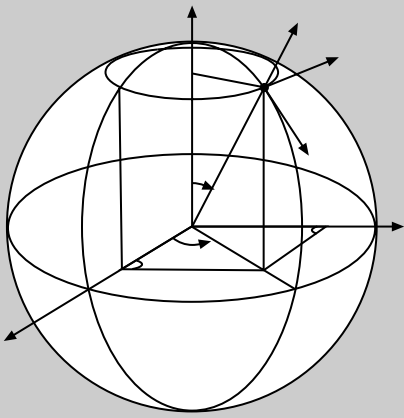

Chapter 24

Systems of Orthogonal Coordinates

24.1 CURVILINEAR COORDINATES

24.1.1 Basic Definitions

24.1.1.1

Let (x, y, z) and (ξ_1, ξ_2, ξ_3) be related by the equations

$$1. \quad x = X(\xi_1, \xi_2, \xi_3), \quad y = Y(\xi_1, \xi_2, \xi_3), \quad z = Z(\xi_1, \xi_2, \xi_3),$$

where the functions X , Y , and Z are continuously differentiable functions of their arguments, and the *Jacobian* determinant

$$2. \quad J = \begin{vmatrix} \frac{\partial X}{\partial \xi_1} & \frac{\partial X}{\partial \xi_2} & \frac{\partial X}{\partial \xi_3} \\ \frac{\partial Y}{\partial \xi_1} & \frac{\partial Y}{\partial \xi_2} & \frac{\partial Y}{\partial \xi_3} \\ \frac{\partial Z}{\partial \xi_1} & \frac{\partial Z}{\partial \xi_2} & \frac{\partial Z}{\partial \xi_3} \end{vmatrix}$$

does not vanish throughout some region R of space. Then R in 24.1.1.1 can be solved uniquely for ξ_1 , ξ_2 , and ξ_3 in terms of x , y , and z to give

$$3. \quad \xi_1 = \Xi_1(x, y, z), \quad \xi_2 = \Xi_2(x, y, z), \quad \xi_3 = \Xi_3(x, y, z).$$

The **position vector** \mathbf{r} of a point in space with the rectangular Cartesian coordinates (x, y, z) can be written

$$4. \quad \mathbf{r} = \mathbf{r}(x, y, z).$$

Then the point P with the rectangular Cartesian coordinates (x_0, y_0, z_0) corresponds to the point with the corresponding coordinates $(\xi_1^{(0)}, \xi_2^{(0)}, \xi_3^{(0)})$ in the new coordinate system, and so to the intersection of the three one-parameter curves (Figure 24.1) defined by

$$5. \quad \mathbf{r} = \mathbf{r}(\xi_1, \xi_2^{(0)}, \xi_3^{(0)}), \quad \mathbf{r} = \mathbf{r}(\xi_1^{(0)}, \xi_2, \xi_3^{(0)}), \quad \mathbf{r} = \mathbf{r}(\xi_1^{(0)}, \xi_2^{(0)}, \xi_3).$$

In general, the coordinates ξ_1, ξ_2, ξ_3 are called **curvilinear coordinates**, and they are said to be **orthogonal** when the unit tangent vectors $\mathbf{e}_1, \mathbf{e}_2$, and \mathbf{e}_3 to the curves $\xi_1 = \xi_1^{(0)}, \xi_2 = \xi_2^{(0)}, \xi_3 = \xi_3^{(0)}$ through $[\xi_1^{(0)}, \xi_2^{(0)}, \xi_3^{(0)}]$ identifying point $P(x_0, y_0, z_0)$ are all mutually orthogonal.

The vectors $\mathbf{e}_1, \mathbf{e}_2$, and \mathbf{e}_3 are defined by

$$6. \quad \frac{\partial \mathbf{r}}{\partial \xi_1} = h_1 \mathbf{e}_1, \quad \frac{\partial \mathbf{r}}{\partial \xi_2} = h_2 \mathbf{e}_2, \quad \frac{\partial \mathbf{r}}{\partial \xi_3} = h_3 \mathbf{e}_3,$$

where the **scale factors** h_1, h_2 , and h_3 are given by

$$7. \quad h_1 = \left| \frac{\partial \mathbf{r}}{\partial \xi_1} \right|, \quad h_2 = \left| \frac{\partial \mathbf{r}}{\partial \xi_2} \right|, \quad h_3 = \left| \frac{\partial \mathbf{r}}{\partial \xi_3} \right|.$$

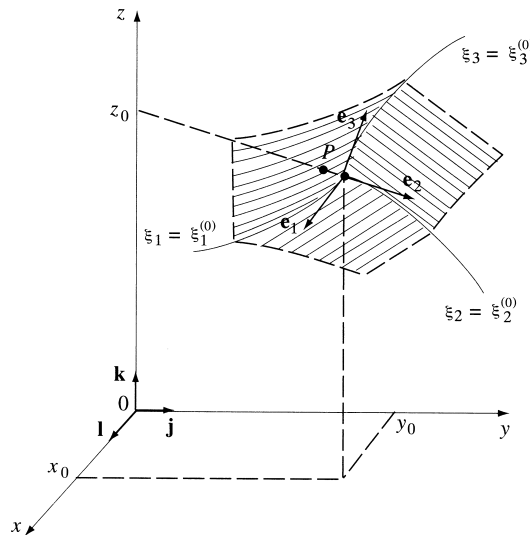

Figure 24.1.

The following general results are valid for orthogonal curvilinear coordinates:

$$8. \quad d\mathbf{r} = h_1 d\xi_1 \mathbf{e}_1 + h_2 d\xi_2 \mathbf{e}_2 + h_3 d\xi_3 \mathbf{e}_3,$$

and if ds is an element of arc length, then

$$(ds)^2 = d\mathbf{r} \cdot d\mathbf{r} = h_1^2 d\xi_1^2 + h_2^2 d\xi_2^2 + h_3^2 d\xi_3^2.$$

24.2 VECTOR OPERATORS IN ORTHOGONAL COORDINATES

24.2.1

Let V be a suitably differentiable scalar function of position, and $\mathbf{F} = F_1 \mathbf{e}_1 + F_2 \mathbf{e}_2 + F_3 \mathbf{e}_3$ be a vector function defined in terms of the orthogonal curvilinear coordinates ξ_1, ξ_2, ξ_3 introduced in 24.1.1. Then the vector operations of **gradient**, **divergence**, and **curl** and the scalar **Laplacian** operator $\nabla^2 V$ take the form:

$$1. \quad \text{grad } V = \nabla V = \frac{1}{h_1} \frac{\partial V}{\partial \xi_1} \mathbf{e}_1 + \frac{1}{h_2} \frac{\partial V}{\partial \xi_2} \mathbf{e}_2 + \frac{1}{h_3} \frac{\partial V}{\partial \xi_3} \mathbf{e}_3$$

$$2. \quad \text{div } \mathbf{F} = \nabla \cdot \mathbf{F} = \frac{1}{h_1 h_2 h_3} \left[\frac{\partial}{\partial \xi_1} (h_2 h_3 F_1) + \frac{\partial}{\partial \xi_2} (h_3 h_1 F_2) + \frac{\partial}{\partial \xi_3} (h_1 h_2 F_3) \right]$$

$$3. \quad \text{curl } \mathbf{F} = \nabla \times \mathbf{F} = \frac{1}{h_1 h_2 h_3} \begin{vmatrix} h_1 \mathbf{e}_1 & h_2 \mathbf{e}_2 & h_3 \mathbf{e}_3 \\ \frac{\partial}{\partial \xi_1} & \frac{\partial}{\partial \xi_2} & \frac{\partial}{\partial \xi_3} \\ h_1 F_1 & h_2 F_2 & h_3 F_3 \end{vmatrix}$$

$$4. \quad \nabla^2 V = \frac{1}{h_1 h_2 h_3} \left[\frac{\partial}{\partial \xi_1} \left(\frac{h_2 h_3}{h_1} \frac{\partial V}{\partial \xi_1} \right) + \frac{\partial}{\partial \xi_2} \left(\frac{h_3 h_1}{h_2} \frac{\partial V}{\partial \xi_2} \right) + \frac{\partial}{\partial \xi_3} \left(\frac{h_1 h_2}{h_3} \frac{\partial V}{\partial \xi_3} \right) \right]$$

The above operations have the following properties:

5. $\nabla(V + W) = \nabla V + \nabla W$
6. $\nabla \cdot (\mathbf{F} + \mathbf{G}) = \nabla \cdot \mathbf{F} + \nabla \cdot \mathbf{G}$
7. $\nabla \cdot (V\mathbf{F}) = V(\nabla \cdot \mathbf{F}) + (\nabla V) \cdot \mathbf{F}$
8. $\nabla \cdot (\nabla V) = \nabla^2 V$
9. $\nabla \times (\mathbf{F} + \mathbf{G}) = \nabla \times \mathbf{F} + \nabla \times \mathbf{G}$
10. $\nabla \times (V\mathbf{F}) = V(\nabla \times \mathbf{F}) + (\nabla V) \times \mathbf{F}$,

where V, W are differentiable scalar functions and \mathbf{F}, \mathbf{G} are differentiable vector functions.

11. In general orthogonal coordinates, the **Helmholtz equation** $H[V] = 0$ in terms of the Laplacian becomes $H[V] \equiv \nabla^2 V + \lambda V = 0$, where λ is a parameter. The Helmholtz equation is usually obtained as a result of applying the method of separation of variables to the wave equation or the heat equation when the parameter λ enters as a separation constant.

24.3 SYSTEMS OF ORTHOGONAL COORDINATES

24.3.1

The following are the most frequently used systems of orthogonal curvilinear coordinates. In each case the relationship between the curvilinear coordinates and Cartesian coordinates is given together with the scale factors h_1, h_2, h_3 and the form taken by ∇V , $\nabla \cdot \mathbf{F}$, $\nabla \times \mathbf{F}$, and $\nabla^2 V$.

1. In terms of a right-handed set of **rectangular Cartesian coordinates** $0\{x, y, z\}$ with the fixed unit vectors \mathbf{i} , \mathbf{j} , and \mathbf{k} along the x -, y -, and z -axes, respectively, and scalar V and vector $\mathbf{F} = F_1\mathbf{i} + F_2\mathbf{j} + F_3\mathbf{k}$:

$$(a) \text{ grad } V = \nabla V = \frac{\partial V}{\partial x}\mathbf{i} + \frac{\partial V}{\partial y}\mathbf{j} + \frac{\partial V}{\partial z}\mathbf{k}$$

$$(b) \text{ div } \mathbf{F} = \nabla \cdot \mathbf{F} = \frac{\partial F_1}{\partial x} + \frac{\partial F_2}{\partial y} + \frac{\partial F_3}{\partial z}$$

$$(c) \text{ curl } \mathbf{F} = \nabla \times \mathbf{F} = \begin{vmatrix} \mathbf{i} & \mathbf{j} & \mathbf{k} \\ \frac{\partial}{\partial x} & \frac{\partial}{\partial y} & \frac{\partial}{\partial z} \\ F_1 & F_2 & F_3 \end{vmatrix}$$

$$(d) \nabla^2 V = \frac{\partial^2 V}{\partial x^2} + \frac{\partial^2 V}{\partial y^2} + \frac{\partial^2 V}{\partial z^2}$$

- (e) The Helmholtz equation $H[V] = 0$ becomes

$$\frac{\partial^2 V}{\partial x^2} + \frac{\partial^2 V}{\partial y^2} + \frac{\partial^2 V}{\partial z^2} + \lambda V = 0$$

2. **Cylindrical polar coordinates** (r, θ, z) are three-dimensional coordinates defined as in Figure 24.2.

$$(a) x = r \cos \theta, \quad y = r \sin \theta, \quad z = z \quad [0 \leq \theta \leq 2\pi]$$

$$(b) h_1^2 = 1, \quad h_2^2 = r^2, \quad h_3^2 = 1$$

$$(c) \mathbf{F} = F_1\mathbf{e}_r + F_2\mathbf{e}_\theta + F_3\mathbf{e}_z$$

$$(d) \text{ grad } V = \nabla V = \frac{\partial V}{\partial r}\mathbf{e}_r + \frac{1}{r}\frac{\partial V}{\partial \theta}\mathbf{e}_\theta + \frac{\partial V}{\partial z}\mathbf{e}_z$$

$$(e) \operatorname{div} \mathbf{F} = \nabla \cdot \mathbf{F} = \frac{1}{r} \left[\frac{\partial}{\partial r} (rF_1) + \frac{\partial F_2}{\partial \theta} + r \frac{\partial F_3}{\partial z} \right]$$

$$(f) \operatorname{curl} \mathbf{F} = \nabla \times \mathbf{F} = \frac{1}{r} \begin{vmatrix} \mathbf{e}_r & r\mathbf{e}_\theta & \mathbf{e}_z \\ \frac{\partial}{\partial r} & \frac{\partial}{\partial \theta} & \frac{\partial}{\partial z} \\ F_1 & rF_2 & F_3 \end{vmatrix}$$

$$(g) \nabla^2 V = \frac{1}{r} \left[\frac{\partial}{\partial r} \left(r \frac{\partial V}{\partial r} \right) + \frac{1}{r} \frac{\partial}{\partial \theta} \left(\frac{\partial V}{\partial \theta} \right) + \frac{\partial}{\partial z} \left(r \frac{\partial V}{\partial z} \right) \right]$$

The corresponding expressions for **plane polar coordinates** follow from (a) to (g) above by omitting the terms involving z , and by confining attention to the plane $z = 0$ in Figure 24.2.

(h) The Helmholtz equation $H[V] = 0$ becomes

$$\frac{1}{r} \left[\frac{\partial}{\partial r} \left(r \frac{\partial V}{\partial r} \right) + \frac{1}{r} \frac{\partial}{\partial \theta} \left(\frac{\partial V}{\partial \theta} \right) + \frac{\partial}{\partial z} \left(r \frac{\partial V}{\partial z} \right) \right] + \lambda V = 0$$

3. **Spherical coordinates** (r, θ, ϕ) are three-dimensional coordinates defined as in Figure 24.3.

$$(a) x = r \sin \theta \cos \phi, \quad y = r \sin \theta \sin \phi, \quad z = r \cos \theta, \quad [0 \leq \theta \leq \pi, 0 \leq \phi < 2\pi]$$

$$(b) h_1^2 = 1, \quad h_2^2 = r^2, \quad h_3^2 = r^2 \sin^2 \theta$$

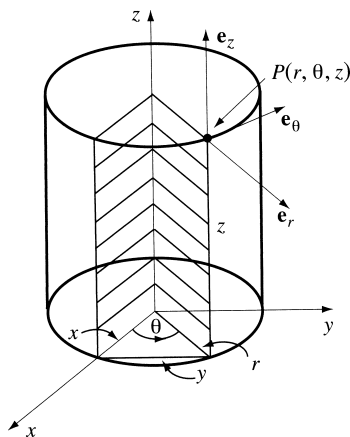

Figure 24.2.

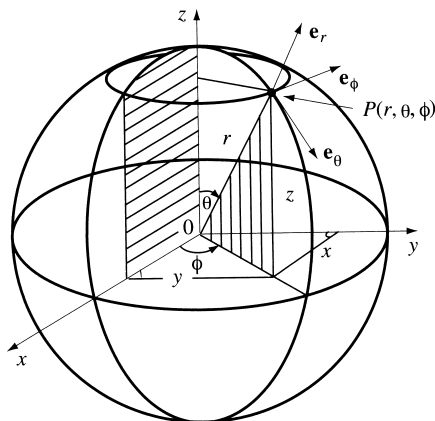

Figure 24.3.

$$(c) \mathbf{F} = F_1 \mathbf{e}_r + F_2 \mathbf{e}_\theta + F_3 \mathbf{e}_\phi$$

$$(d) \text{grad } V = \frac{\partial V}{\partial r} \mathbf{e}_r + \frac{1}{r} \frac{\partial V}{\partial \theta} \mathbf{e}_\theta + \frac{1}{r \sin \theta} \frac{\partial V}{\partial \phi} \mathbf{e}_\phi$$

$$(e) \text{div } \mathbf{F} = \nabla \cdot \mathbf{F} = \frac{1}{r^2} \frac{\partial}{\partial r} (r^2 F_1) + \frac{1}{r \sin \theta} \frac{\partial}{\partial \theta} (\sin \theta F_2) + \frac{1}{r \sin \theta} \frac{\partial F_3}{\partial \phi}$$

$$(f) \text{curl } \mathbf{F} = \nabla \times \mathbf{F} = \frac{1}{r^2 \sin \theta} \begin{vmatrix} \mathbf{e}_r & r \mathbf{e}_\theta & r \sin \theta \mathbf{e}_\phi \\ \frac{\partial}{\partial r} & \frac{\partial}{\partial \theta} & \frac{\partial}{\partial \phi} \\ F_1 & r F_2 & r \sin \theta F_3 \end{vmatrix}$$

$$(g) \nabla^2 V = \frac{1}{r^2} \frac{\partial}{\partial r} \left(r^2 \frac{\partial V}{\partial r} \right) + \frac{1}{r^2 \sin \theta} \frac{\partial}{\partial \theta} \left(\sin \theta \frac{\partial V}{\partial \theta} \right) + \frac{1}{r^2 \sin^2 \theta} \frac{\partial^2 V}{\partial \phi^2}$$

(h) The Helmholtz equation $H[V] = 0$ becomes

$$\frac{1}{r^2} \frac{\partial}{\partial r} \left(r^2 \frac{\partial V}{\partial r} \right) + \frac{1}{r^2 \sin \theta} \frac{\partial}{\partial \theta} \left(\sin \theta \frac{\partial V}{\partial \theta} \right) + \frac{1}{r^2 \sin^2 \theta} \frac{\partial^2 V}{\partial \phi^2} + \lambda V = 0$$

4. **Bipolar coordinates** (u, v, z) are three-dimensional coordinates defined as in Figure 24.4, which shows the coordinate system in the plane $z = 0$. In three dimensions the translation of these coordinate curves parallel to the z -axis generates cylindrical coordinate surfaces normal to the plane $z = 0$.

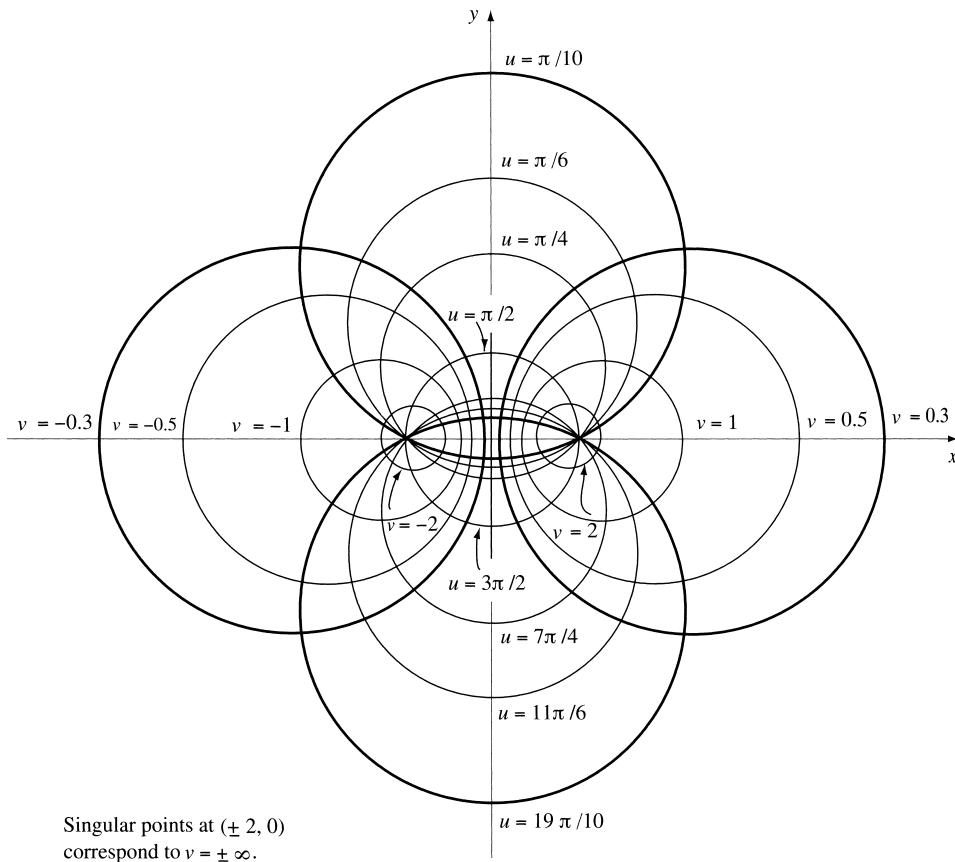

Figure 24.4.

- (a) $x = \frac{a \sinh v}{\cosh v - \cos u}$, $y = \frac{a \sin u}{\cosh v - \cos u}$, $z = z$
 $[0 \leq u < 2\pi, -\infty < v < \infty, -\infty < z < \infty]$
- (b) $h_1^2 = h_2^2 = R^2 = \frac{a^2}{(\cosh v - \cos u)^2}$, $h_3^2 = 1$
- (c) $\mathbf{F} = F_1 \mathbf{e}_u + F_2 \mathbf{e}_v + F_3 \mathbf{e}_z$
- (d) $\text{grad } V = \frac{1}{R} \left(\frac{\partial V}{\partial u} \mathbf{e}_u + \frac{\partial V}{\partial v} \mathbf{e}_v \right) + \frac{\partial V}{\partial z} \mathbf{e}_z$
- (e) $\text{div } \mathbf{F} = \nabla \cdot \mathbf{F} = \frac{1}{R^2} \left[\frac{\partial}{\partial u} (R F_1) + \frac{\partial}{\partial v} (R F_2) + \frac{\partial}{\partial z} (R^2 F_3) \right]$

$$(f) \operatorname{curl} \mathbf{F} = \nabla \times \mathbf{F} = \frac{1}{R^2} \begin{vmatrix} R\mathbf{e}_u & R\mathbf{e}_v & \mathbf{e}_z \\ \frac{\partial}{\partial u} & \frac{\partial}{\partial v} & \frac{\partial}{\partial z} \\ RF_1 & RF_2 & F_3 \end{vmatrix}$$

$$(g) \nabla^2 V = \frac{1}{R^2} \left(\frac{\partial^2 V}{\partial u^2} + \frac{\partial^2 V}{\partial v^2} \right) + \frac{\partial^2 V}{\partial z^2}$$

(h) The Helmholtz equation follows from $H[V] = \nabla^2 V + \lambda V = 0$, by substituting the Laplacian in (g).

5. **Toroidal coordinates** (u, v, ϕ) are three-dimensional coordinates defined in terms of two-dimensional bipolar coordinates. They are obtained by relabeling the y -axis in Figure 24.4 as the z -axis, and then rotating the curves $u = \text{const.}$ and $v = \text{const.}$ about the new z -axis so that each curve $v = \text{const.}$ generates a **torus**. The angle ϕ is measured about the z -axis from the (x, z) -plane, with $0 \leq \phi < 2\pi$.

$$(a) x = \frac{a \sinh v \cos \phi}{\cosh v - \cos u}, \quad y = \frac{a \sinh v \sin \phi}{\cosh v - \cos u}, \quad z = \frac{a \sinh u}{\cosh v - \cos u},$$

$$[0 \leq u < 2\pi, -\infty < v < \infty, 0 \leq \phi < 2\pi]$$

$$(b) h_1^2 = h_2^2 = R^2 = \frac{a^2}{(\cosh v - \cos u)^2}, \quad h_3^2 = \frac{a^2 \sinh^2 v}{(\cosh v - \cos u)^2}$$

$$(c) \mathbf{F} = F_1 \mathbf{e}_u + F_2 \mathbf{e}_v + F_3 \mathbf{e}_\phi$$

where $\mathbf{e}_u, \mathbf{e}_v, \mathbf{e}_\phi$ are the unit vectors in the toroidal coordinates.

$$(d) \operatorname{grad} V = \nabla V = \frac{1}{R} \left(\frac{\partial V}{\partial u} \mathbf{e}_u + \frac{\partial V}{\partial v} \mathbf{e}_v \right) + \frac{1}{R \sinh v} \frac{\partial V}{\partial \phi} \mathbf{e}_\phi$$

$$(e) \operatorname{div} \mathbf{F} = \nabla \cdot \mathbf{F} = \frac{1}{R^3 \sinh v} \left[\frac{\partial}{\partial u} (R^2 \sinh v F_1) + \frac{\partial}{\partial v} (R^2 \sinh v F_2) + \frac{\partial}{\partial \phi} (R^2 F_3) \right]$$

$$(f) \operatorname{curl} \mathbf{F} = \nabla \times \mathbf{F} = \frac{1}{\sinh v} \begin{vmatrix} \mathbf{e}_u & \mathbf{e}_v & \sinh v \mathbf{e}_\phi \\ \frac{\partial}{\partial u} & \frac{\partial}{\partial v} & \frac{\partial}{\partial \phi} \\ F_1 & F_2 & \sinh v F_3 \end{vmatrix}$$

$$(g) \nabla^2 V = \frac{1}{R^3 \sinh v} \left[\frac{\partial}{\partial u} \left(R \sinh v \frac{\partial V}{\partial u} \right) + \frac{\partial}{\partial v} \left(R \sinh v \frac{\partial V}{\partial v} \right) + \frac{\partial}{\partial \phi} \left(\frac{R}{\sinh v} \frac{\partial V}{\partial \phi} \right) \right]$$

(h) The Helmholtz equation follows from $H[V] = \nabla^2 V + \lambda V = 0$, by substituting the Laplacian in (g).

6. **Parabolic cylindrical coordinates** (u, v, z) are three-dimensional coordinates defined as in Figure 24.5, which shows the coordinate system in the plane $z = 0$. In three dimensions the translation of these coordinate curves parallel to the z -axis generates parabolic cylindrical coordinate surfaces normal to the plane $z = 0$.

$$(a) \quad x = \frac{1}{2}(u^2 - v^2), \quad y = uv, \quad z = z$$

$$(b) \quad h_1^2 = h_2^2 = h^2 = u^2 + v^2, \quad h_3^2 = 1$$

$$(c) \quad \mathbf{F} = F_1 \mathbf{e}_u + F_2 \mathbf{e}_v + F_3 \mathbf{e}_z$$

$$(d) \quad \text{grad } V = \nabla V = \frac{1}{h} \left(\frac{\partial V}{\partial u} \mathbf{e}_u + \frac{\partial V}{\partial v} \mathbf{e}_v \right) + \frac{1}{uv} \frac{\partial V}{\partial z} \mathbf{e}_z$$

$$(e) \quad \text{div } \mathbf{F} = \nabla \cdot \mathbf{F} = \frac{1}{h^2} \left[\frac{\partial}{\partial u} (hF_1) + \frac{\partial}{\partial v} (hF_2) + \frac{\partial}{\partial z} (h^2 F_3) \right]$$

$$(f) \quad \text{curl } \mathbf{F} = \nabla \times \mathbf{F} = \frac{1}{h^2} \begin{vmatrix} h\mathbf{e}_u & h\mathbf{e}_v & \mathbf{e}_z \\ \frac{\partial}{\partial u} & \frac{\partial}{\partial v} & \frac{\partial}{\partial z} \\ hF_1 & hF_2 & F_3 \end{vmatrix}$$

$$(g) \quad \nabla^2 V = \frac{1}{h^2} \left(\frac{\partial^2 V}{\partial u^2} + \frac{\partial^2 V}{\partial v^2} \right) + \frac{\partial^2 V}{\partial z^2}$$

- (h) The Helmholtz equation follows from $H[V] = \nabla^2 V + \lambda V = 0$, by substituting the Laplacian in (g).

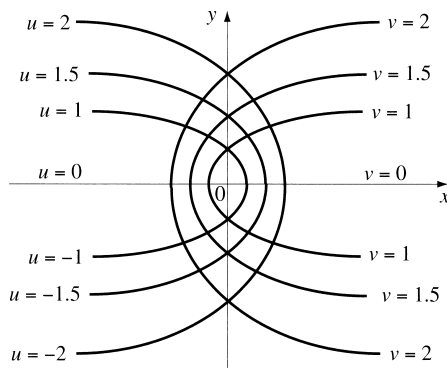

Figure 24.5.

7. **Paraboloidal coordinates** (u, v, ϕ) are three-dimensional coordinates defined in terms of two-dimensional parabolic cylindrical coordinates. They are obtained by relabeling the x - and y -axes in Figure 24.5 as the z - and x -axes, respectively, and then rotating the curves about the new z -axis, so that each parabola generates a paraboloid. The angle ϕ is measured about the z -axis from the (x, z) -plane, with $0 \leq \phi < 2\pi$.

$$(a) \quad x = uv \cos \phi, \quad y = uv \sin \phi, \quad z = \frac{1}{2}(u^2 - v^2) \quad [u \geq 0, v \geq 0, 0 \leq \phi < 2\pi]$$

$$(b) \quad h_1^2 = h_2^2 = h^2 = u^2 + v^2, \quad h_3^2 = u^2 v^2$$

$$(c) \quad \mathbf{F} = F_1 \mathbf{e}_u + F_2 \mathbf{e}_v + F_3 \mathbf{e}_\phi$$

where $\mathbf{e}_u, \mathbf{e}_v, \mathbf{e}_\phi$ are the unit vectors in the paraboloidal coordinates.

$$(d) \quad \text{grad } V = \nabla V = \frac{1}{h} \left(\frac{\partial V}{\partial u} \mathbf{e}_u + \frac{\partial V}{\partial v} \mathbf{e}_v \right) + \frac{1}{uv} \frac{\partial V}{\partial \phi} \mathbf{e}_\phi$$

$$(e) \quad \text{div } \mathbf{F} = \nabla \cdot \mathbf{F} = \frac{1}{h^2 uv} \left[\frac{\partial}{\partial u} (huv F_1) + \frac{\partial}{\partial v} (huv F_2) + \frac{\partial}{\partial \phi} (h^2 F_3) \right]$$

$$(f) \quad \text{curl } \mathbf{F} = \nabla \times \mathbf{F} = \begin{vmatrix} \mathbf{e}_u & \mathbf{e}_v & \frac{uv}{h} \mathbf{e}_\phi \\ \frac{\partial}{\partial u} & \frac{\partial}{\partial v} & \frac{\partial}{\partial \phi} \\ F_1 & F_2 & \frac{uv}{h} F_3 \end{vmatrix}$$

$$(g) \quad \nabla^2 V = \frac{1}{h^2 u} \frac{\partial}{\partial u} \left(u \frac{\partial V}{\partial u} \right) + \frac{1}{h^2 v} \frac{\partial}{\partial v} \left(v \frac{\partial V}{\partial v} \right) + \frac{1}{u^2 v^2} \frac{\partial^2 V}{\partial \phi^2}$$

- (h) The Helmholtz equation follows from $H[V] = \nabla^2 V + \lambda V = 0$, by substituting the Laplacian in (g).

8. **Elliptic cylindrical coordinates** (u, v, z) are three-dimensional coordinates defined as in Figure 24.6, which shows the coordinate system in the plane $z = 0$. In three-dimensions the translation of the coordinate curves parallel to the z -axis generates elliptic cylinders corresponding to the curves $u = \text{const.}$, and parabolic cylinders corresponding to the curves $v = \text{const.}$

$$(a) \quad x = a \cosh u \cos v, \quad y = a \sinh u \sin v, \quad z = z \quad [u \geq 0, 0 \leq v < 2\pi, -\infty < z < \infty]$$

$$(b) \quad h_1^2 = h_2^2 = h^2 = a^2 (\sinh^2 u + \sin^2 v), \quad h_3^2 = 1$$

$$(c) \quad \mathbf{F} = F_1 \mathbf{e}_u + F_2 \mathbf{e}_v + F_3 \mathbf{e}_z$$

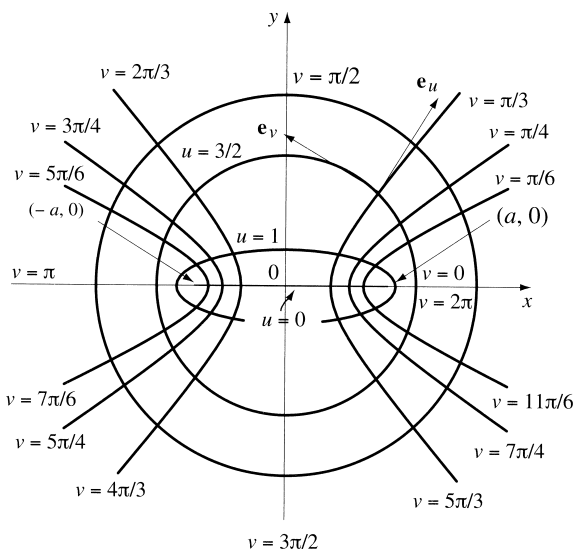

Figure 24.6.

$$(d) \operatorname{grad} V = \frac{1}{h} \frac{\partial V}{\partial u} \mathbf{e}_u + \frac{1}{h} \frac{\partial V}{\partial v} \mathbf{e}_v + \frac{\partial V}{\partial z} \mathbf{e}_z$$

$$(e) \operatorname{div} \mathbf{F} = \nabla \cdot \mathbf{F} = \frac{1}{h} \left[\frac{\partial}{\partial u} (hF_1) + \frac{\partial}{\partial v} (hF_2) \right] + \frac{\partial F_3}{\partial z}$$

$$(f) \operatorname{curl} \mathbf{F} = \nabla \times \mathbf{F} = \frac{1}{h^2} \begin{vmatrix} h\mathbf{e}_u & h\mathbf{e}_v & \mathbf{e}_z \\ \frac{\partial}{\partial u} & \frac{\partial}{\partial v} & \frac{\partial}{\partial z} \\ hF_1 & hF_2 & F_3 \end{vmatrix}$$

$$(g) \nabla^2 V = \frac{1}{h^2} \left(\frac{\partial^2 V}{\partial u^2} + \frac{\partial^2 V}{\partial v^2} \right) + \frac{\partial^2 V}{\partial z^2}$$

(h) The Helmholtz equation follows from $H[V] = \nabla^2 V + \lambda V = 0$, by substituting the Laplacian in (g).

9. **Prolate spheroidal coordinates** (ξ, η, ϕ) are three-dimensional coordinates defined in terms of two-dimensional elliptic cylindrical coordinates. They are obtained by relabeling the x -axis in Figure 24.6 as the z -axis, rotating the coordinate curves about the new z -axis, and taking as the family of coordinate surfaces planes containing this axis. The curves $u = \text{const.}$ then generate prolate spheroidal surfaces.

$$(a) \quad x = a \sinh \xi \sin \eta \cos \phi, \quad y = a \sinh \xi \sin \eta \sin \phi, \quad z = a \cosh \xi \cos \eta$$

$$[\xi \geq 0, 0 \leq \eta \leq \pi, 0 \leq \phi < 2\pi]$$

$$(b) \quad h_1^2 = h_2^2 = h^2 = a^2 (\sinh^2 \xi + \sin^2 \eta), \quad h_3^2 = a^2 \sinh^2 \xi \sin^2 \eta$$

$$(c) \quad \mathbf{F} = F_1 \mathbf{e}_\xi + F_2 \mathbf{e}_\eta + F_3 \mathbf{e}_\phi$$

$$(d) \quad \text{grad } V = \frac{1}{h} \frac{\partial V}{\partial \xi} \mathbf{e}_\xi + \frac{1}{h} \frac{\partial V}{\partial \eta} \mathbf{e}_\eta + \frac{1}{h_3} \frac{\partial V}{\partial \phi} \mathbf{e}_\phi$$

$$(e) \quad \text{div } \mathbf{F} = \nabla \cdot \mathbf{F} = \frac{1}{h^2 h_3} \left[\frac{\partial}{\partial \xi} (h h_3 F_1) + \frac{\partial}{\partial \eta} (h h_3 F_2) \right] + \frac{1}{h_3} \frac{\partial F_3}{\partial \phi}$$

$$(f) \quad \text{curl } \mathbf{F} = \nabla \times \mathbf{F} = \frac{1}{h^2 h_3} \begin{vmatrix} h \mathbf{e}_\xi & h \mathbf{e}_\eta & h_3 \mathbf{e}_\phi \\ \frac{\partial}{\partial \xi} & \frac{\partial}{\partial \eta} & \frac{\partial}{\partial \phi} \\ h F_1 & h F_2 & h_3 F_3 \end{vmatrix}$$

$$(g) \quad \nabla^2 V = \frac{1}{h^2 \sinh \xi} \frac{\partial}{\partial \xi} \left(\sinh \xi \frac{\partial V}{\partial \xi} \right) + \frac{1}{h^2 \sin \eta} \frac{\partial}{\partial \eta} \left(\sin \eta \frac{\partial V}{\partial \eta} \right) + \frac{1}{a^2 \sinh^2 \xi \sin^2 \eta} \frac{\partial^2 V}{\partial \phi^2}$$

(h) The Helmholtz equation follows from $H[V] = \nabla^2 V + \lambda V = 0$, by substituting the Laplacian in (g).

10. **Oblate spheroidal coordinates** (ξ, η, ϕ) are three-dimensional coordinates defined in terms of two-dimensional elliptic cylindrical coordinates. They are obtained by relabeling the y -axis in Figure 24.6 as the z -axis, rotating the coordinate curves about the new z -axis, and taking as the third family of coordinate surfaces planes containing this axis. The curves $u = \text{const.}$ then generate oblate spheroidal surfaces.

$$(a) \quad x = a \cosh \xi \cos \eta \cos \phi, \quad y = a \cosh \xi \cos \eta \sin \phi, \quad z = a \sinh \xi \sin \eta$$

$$[\xi \geq 0, -\pi/2 \leq \eta \leq \pi/2, 0 \leq \phi < 2\pi]$$

$$(b) \quad h_1^2 = h_2^2 = h^2 = a^2 (\sinh^2 \xi + \sin^2 \eta), \quad h_3^2 = a^2 \cosh^2 \xi \cos^2 \eta$$

$$(c) \quad \mathbf{F} = F_1 \mathbf{e}_\xi + F_2 \mathbf{e}_\eta + F_3 \mathbf{e}_\phi$$

$$(d) \quad \text{grad } V = \nabla V = \frac{1}{h} \frac{\partial V}{\partial \xi} \mathbf{e}_\xi + \frac{1}{h} \frac{\partial V}{\partial \eta} \mathbf{e}_\eta + \frac{1}{h_3} \frac{\partial V}{\partial \phi} \mathbf{e}_\phi$$

$$(e) \quad \text{div } \mathbf{F} = \nabla \cdot \mathbf{F} = \frac{1}{h^2 h_3} \left[\frac{\partial}{\partial \xi} (h h_3 F_1) + \frac{\partial}{\partial \eta} (h h_3 F_2) \right] + \frac{1}{h_3} \frac{\partial F_3}{\partial \phi}$$

$$(f) \operatorname{curl} \mathbf{F} = \nabla \times \mathbf{F} = \frac{1}{h^2 h_3} \begin{vmatrix} h\mathbf{e}_\xi & h\mathbf{e}_\eta & h_3\mathbf{e}_\phi \\ \frac{\partial}{\partial \xi} & \frac{\partial}{\partial \eta} & \frac{\partial}{\partial \phi} \\ hF_1 & hF_2 & h_3F_3 \end{vmatrix}$$

$$(g) \nabla^2 V = \frac{1}{h^2 \cosh \xi} \frac{\partial}{\partial \xi} \left(\cosh \xi \frac{\partial V}{\partial \xi} \right) + \frac{1}{h^2 \cos \eta} \frac{\partial}{\partial \eta} \left(\cos \eta \frac{\partial V}{\partial \eta} \right) + \frac{1}{a^2 \cosh^2 \xi \cos^2 \eta} \frac{\partial^2 V}{\partial \phi^2}$$

(h) The Helmholtz equation follows from $H[V] = \nabla^2 V + \lambda V = 0$, by substituting the Laplacian in (g).

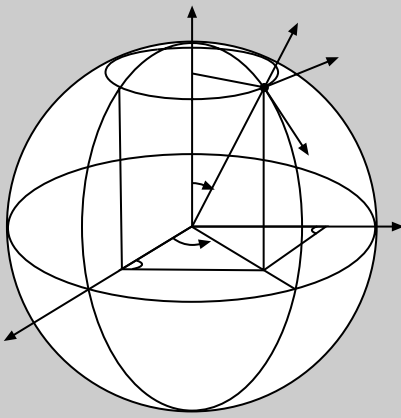

Chapter 25

Partial Differential Equations and Special Functions

25.1 FUNDAMENTAL IDEAS

25.1.1 Classification of Equations

25.1.1.1

A **partial differential equation** (PDE) of **order** n , for an unknown function Φ of the m independent variables x_1, x_2, \dots, x_m ($m \geq 2$), is an equation that relates one or more of the n th-order partial derivatives of Φ to some or all of $\Phi, x_1, x_2, \dots, x_m$ and the partial derivatives of Φ or order less than n .

The most general second-order PDE can be written

$$1. \quad F\left(x_1, x_2, \dots, x_m, \Phi, \frac{\partial \Phi}{\partial x_1}, \dots, \frac{\partial \Phi}{\partial x_m}, \frac{\partial^2 \Phi}{\partial x_1^2}, \dots, \frac{\partial^2 \Phi}{\partial x_i \partial x_j}, \dots, \frac{\partial^2 \Phi}{\partial x_m^2}\right) = 0,$$

where F is an arbitrary function of its arguments. A **solution** of 25.1.1.1 in a region R of the space to which the independent variables belong is a twice differentiable function that satisfies the equation throughout R .

A **boundary value problem** for a PDE arises when its solution is required to satisfy conditions on a boundary in space. If, however, one of the independent variables is the time t and the solution is required to satisfy certain conditions when $t = 0$, this leads to an **initial value problem** for the PDE. Many physical situations involve a combination of both of these situations, and they then lead to an **initial boundary value problem**.

A **linear second-order PDE** for the function $\Phi(x_1, x_2, \dots, x_m)$ is an equation of the form

$$2. \quad \sum_{i,j=1}^m A_{ij} \frac{\partial^2 \Phi}{\partial x_i \partial x_j} + \sum_{i=1}^m B_i \frac{\partial \Phi}{\partial x_i} + C\Phi = f,$$

where the A_{ij} , B_i , C , and f are functions of the m independent variables x_1, x_2, \dots, x_m . The equation is said to be **homogeneous** if $f \equiv 0$, otherwise it is **inhomogeneous (non-homogeneous)**.

The most general linear second-order PDE for the function $\Phi(x, y)$ of the two independent variables x and y is

$$3. \quad A(x, y) \frac{\partial^2 \Phi}{\partial x^2} + 2B(x, y) \frac{\partial^2 \Phi}{\partial x \partial y} + C(x, y) \frac{\partial^2 \Phi}{\partial y^2} \\ + d(x, y) \frac{\partial \Phi}{\partial x} + e(x, y) \frac{\partial \Phi}{\partial y} + f(x, y)\Phi = g(x, y),$$

where x, y may be two spatial variables, or one space variable and the time (usually denoted by t).

An important, more general second-order PDE that is related to 25.1.1.1.1 is

$$4. \quad A \frac{\partial^2 \Phi}{\partial x^2} + 2B \frac{\partial^2 \Phi}{\partial x \partial y} + C \frac{\partial^2 \Phi}{\partial y^2} = H\left(x, y, \Phi, \frac{\partial \Phi}{\partial x}, \frac{\partial \Phi}{\partial y}\right),$$

where A , B , and C , like H , are functions of $x, y, \Phi, \partial\Phi/\partial x$, and $\partial\Phi/\partial y$. A PDE of this type is said to be **quasilinear** (linear in its second (highest) order derivatives).

Linear homogeneous PDEs such as 25.1.1.1.2 and 25.1.1.1.3 have the property that if Φ_1 and Φ_2 are solutions, then so also is $c_1\Phi_1 + c_2\Phi_2$, where c_1 and c_2 are arbitrary constants. This behavior of solutions of PDEs is called the **linear superposition property**, and it is used for the construction of solutions to initial or boundary value problems.

The second-order PDEs 25.1.1.1.3 and 25.1.1.1.4 are classified throughout a region R of the (x, y) -plane according to certain of their mathematical properties that depend on the sign of $\Delta = B^2 - AC$. The equations are said to be of **hyperbolic type (hyperbolic)** whenever $\Delta > 0$, to be of **parabolic type (parabolic)** whenever $\Delta = 0$, and to be of **elliptic type (elliptic)** whenever $\Delta < 0$.

The most important linear homogeneous second-order PDEs in one, two, or three space dimensions and time are:

$$5. \quad \frac{1}{c^2} \frac{\partial^2 \Phi}{\partial t^2} = \nabla^2 \Phi \quad (\text{wave equation: hyperbolic}) \\ 6. \quad k \frac{\partial \Phi}{\partial t} = \nabla^2 \Phi \quad [\text{diffusion (heat) equation: parabolic}] \\ 7. \quad \nabla^2 \Phi = 0 \quad (\text{Laplace's equation: elliptic}),$$

where c and k are constants, and the form taken by the **Laplacian** $\nabla^2\Phi$ is determined by the coordinate system that is used. Laplace's equation is independent of the time and may be regarded as the **steady-state** form of the two previous equations, in the sense that they reduce to it if, after a suitably long time, their time derivatives may be neglected.

Only in exceptional cases is it possible to find general solutions of PDEs, so instead it becomes necessary to develop techniques that enable them to be solved subject to auxiliary conditions (initial and boundary conditions) that identify specific problems. The most frequently used initial and boundary conditions for second-order PDEs are those of Cauchy, Dirichlet, Neumann, and Robin. For simplicity these conditions are now described for second-order PDEs involving two independent variables, although they can be extended to the case of more independent variables in an obvious manner.

When the time t enters as an independent variable, a problem involving a PDE is said to be a **pure initial value problem** if it is completely specified by describing how the solution starts at time $t = 0$, and no spatial boundaries are involved. If only a first-order time derivative $\partial\Phi/\partial t$ of the solution Φ occurs in the PDE, as in the heat equation, the initial condition involving the specification of Φ at $t = 0$ is called a **Cauchy condition**. If, however, a second-order time derivative $\partial^2\Phi/\partial t^2$ occurs in the PDE, as in the wave equation, the **Cauchy conditions** on the initial line involve the specification of both Φ and $\partial\Phi/\partial t$ at $t = 0$. In each of these cases, the determination of the solution Φ that satisfies both the PDE and the Cauchy condition(s) is called a **Cauchy problem**. More generally, **Cauchy conditions** on an arc Γ involve the specification of Φ and $\partial\Phi/\partial n$ on Γ , where $\partial\Phi/\partial n$ is the derivative of Φ normal to Γ .

In other problems only the spatial variables x and y are involved in a PDE that contains both the terms $\partial^2\Phi/\partial x^2$ and $\partial^2\Phi/\partial y^2$ and governs the behavior of Φ in a region D of the (x, y) -plane. The region D will be assumed to lie within a closed boundary curve Γ that is smooth at all but a finite number of points, at which sharp corners occur (region D is *bounded*). A **Dirichlet condition** for such a PDE involves the specification of Φ on Γ . If $\partial\Phi/\partial n = \mathbf{n} \cdot \text{grad } \Phi$, with \mathbf{n} the inward drawn normal to Γ , a **Neumann condition** involves the specification of $\partial\Phi/\partial n$ on Γ . A **Robin condition** arises when Φ is required to satisfy the condition $\alpha(x, y)\Phi + \beta(x, y)\partial\Phi/\partial n = h(x, y)$ on Γ , where h may be identically zero.

The determinations of the solutions Φ satisfying both the PDE and Dirichlet, Neumann, or Robin conditions on Γ are called **boundary value problems of the Dirichlet, Neumann, or Robin types**, respectively.

When a PDE subject to auxiliary conditions gives rise to a solution that is unique (except possibly for an arbitrary additive constant), and depends continuously on the data in the auxiliary conditions, it is said to be **well posed**, or **properly posed**. An **ill-posed** problem is one in which the solution does not possess the above properties.

Well-posed problems for the **Poisson equation** (the inhomogeneous Laplace equation)

$$8. \quad \nabla^2\Phi(x, y) = H(x, y)$$

involving the above conditions are as follows:

The Dirichlet problem

$$9. \quad \nabla^2 \Phi(x, y) = H(x, y) \text{ in } D \quad \text{with } \Phi = f(x, y) \text{ on } \Gamma$$

yields a unique solution that depends continuously on the inhomogeneous term $H(x, y)$ and the boundary data $f(x, y)$.

The Neumann problem

$$10. \quad \nabla^2 \Phi(x, y) = H(x, y) \text{ in } D \quad \text{with } \partial\Phi/\partial n = g(x, y) \text{ on } \Gamma$$

yields a unique solution, apart from an arbitrary additive constant, that depends continuously on the inhomogeneous term $H(x, y)$ and the boundary data $g(x, y)$, provided that H and g satisfy the **compatibility condition**

$$11. \quad \int_D H(x, y) dA = \int_\Gamma g d\sigma,$$

where dA is the element of area in D and $d\sigma$ is the element of arc length along Γ . No solution exists if the compatibility condition is not satisfied.

The Robin problem

$$12. \quad \nabla^2 \Phi(x, y) = H(x, y) \text{ in } D \quad \text{with } \alpha\Phi + \beta \frac{\partial\Phi}{\partial n} = h \text{ on } \Gamma$$

yields a unique solution that depends continuously on the inhomogeneous term $H(x, y)$ and the boundary data $\alpha(x, y)$, $\beta(x, y)$, and $h(x, y)$.

If the PDE holds in a region D that is *unbounded*, the above conditions that ensure well-posed problems for the Poisson equation must be modified as follows:

Dirichlet conditions Add the requirement that Φ is bounded in D .

Neumann conditions Delete the compatibility condition and add the requirement that $\Phi(x, y) \rightarrow 0$ as $x^2 + y^2 \rightarrow \infty$.

Robin conditions Add the requirement that Φ is bounded in D .

The variability of the coefficients $A(x, y)$, $B(x, y)$, and $C(x, y)$ in 25.1.1.1.3 can cause the equation to change its type in different regions of the (x, y) -plane. An equation exhibiting this property is said to be of **mixed type**. One of the most important equations of mixed type is the **Tricomi equation**

$$y \frac{\partial^2 \Phi}{\partial x^2} + \frac{\partial^2 \Phi}{\partial y^2} = 0,$$

which first arose in the study of transonic flow. This equation is elliptic for $y > 0$, hyperbolic for $y < 0$, and degenerately parabolic along the line $y = 0$. Such equations are difficult to study because the appropriate auxiliary conditions vary according to the type of the equation. When a solution is required in a region within which the parabolic degeneracy occurs, the matching of the solution across the degeneracy gives rise to considerable mathematical difficulties.

25.2 METHOD OF SEPARATION OF VARIABLES

25.2.1 Application to a Hyperbolic Problem

25.2.1.1

The method of **separation of variables** is a technique for the determination of the solution of a boundary value or an initial value problem for a linear homogeneous equation that involves attempting to separate the spatial behavior of a solution from its time variation (**temporal behavior**). It will suffice to illustrate the method by considering the special linear homogeneous second-order hyperbolic equation

$$1. \quad \operatorname{div}(k\nabla\phi) - h\phi = \rho \frac{\partial^2\phi}{\partial t^2},$$

in which $k > 0$, $h \geq 0$, and $\phi(x, t)$ is a function of position vector \mathbf{x} , and the time t . A typical **homogeneous boundary condition** to be satisfied by ϕ on some fixed surface S in space bounding a volume V is

$$2. \quad \left(k_1 \frac{\partial\phi}{\partial n} + k_2\phi \right)_S = 0,$$

where k_1, k_2 are constants and $\partial/\partial n$ denotes the derivative of ϕ normal to S . The appropriate *initial conditions* to be satisfied by ϕ when $t = 0$ are

$$3. \quad \phi(S, 0) = \phi_1(S) \quad \text{and} \quad \frac{\partial\phi}{\partial t}(S, 0) = \phi_2(S).$$

The homogeneity of both 25.2.1.1.1 and the boundary condition 25.2.1.1.2 means that if $\tilde{\phi}_1$ and $\tilde{\phi}_2$ are solutions of 25.2.1.1.1 by satisfying 25.2.1.1.2, then the function $c_1\tilde{\phi}_1 + c_2\tilde{\phi}_2$ with c_1, c_2 being arbitrary constants will also satisfy the same equation and boundary condition.

The method of **separation of variables** proceeds by seeking a solution of the form

$$4. \quad \phi(x, t) = U(\mathbf{x})T(t),$$

in which $U(\mathbf{x})$ is a function only on the spatial position vector \mathbf{x} , and $T(t)$ is a function only of the time t .

Substitution of 25.2.1.1.4 into 25.2.1.1.1, followed by division by $\rho U(\mathbf{x})T(t)$, gives

$$5. \quad \frac{L[U]}{\rho U} = \frac{T''}{T},$$

where $T'' = d^2T/dt^2$, and we have set

$$6. \quad L[U] = \operatorname{div}(k\nabla U) - hU.$$

The spatial vector \mathbf{x} has been *separated* from the time variable t in 25.2.1.1.5, so the left-hand side is a function only of \mathbf{x} , whereas the right-hand side is a function only of t . It is only possible for these functions of \mathbf{x} and t to be equal for all \mathbf{x} and t if

$$7. \quad \frac{L[U]}{\rho U} = \frac{T''}{T} = -\lambda,$$

with λ an absolute constant called the **separation constant**. This result reduces to the equation

$$8. \quad L[U] + \lambda\rho U = 0,$$

with the boundary condition

$$9. \quad \left(k_1 \frac{\partial U}{\partial n} + k_2 U \right)_S = 0$$

governing the spatial variation of the solution, and the equation

$$10. \quad T'' + \lambda T = 0,$$

with

$$11. \quad T(0) = \phi_1 \quad \text{and} \quad T'(0) = \phi_2,$$

governing the time variation of the solution.

Problem 25.2.1.1.8 subject to boundary condition 25.2.1.1.9 is called a **Sturm-Liouville problem**, and it only has **nontrivial solutions** (not identically zero) for special values $\lambda_1, \lambda_2, \dots$ of λ called the **eigenvalues** of the problem. The solutions U_1, U_2, \dots , corresponding to the eigenvalues $\lambda_1, \lambda_2, \dots$, are called the **eigenfunctions** of the problem.

The solution of 25.2.1.1.10 for each $\lambda_1, \lambda_2, \dots$, subject to the initial conditions of 25.2.1.1.11, may be written

$$12. \quad T_n(t) = C_n \cos \sqrt{\lambda_n} t + D_n \sin \sqrt{\lambda_n} t \quad [n = 1, 2, \dots]$$

so that

$$\Phi_n(x, t) = U_n(x) T_n(t).$$

The solution of the original problem is then sought in the form of the linear combination

$$13. \quad \phi(x, t) = \sum_{n=1}^{\infty} U_n(x) [C_n \cos \sqrt{\lambda_n} t + D_n \sin \sqrt{\lambda_n} t].$$

To determine the constants C_n and D_n it is necessary to use a fundamental property of eigenfunctions. Setting

$$14. \quad \|U_n\|^2 = \int_D \rho(\mathbf{x}) U_n^2(\mathbf{x}) dV,$$

and using the Gauss divergence theorem, it follows that the eigenfunctions $U_n(\mathbf{x})$ are orthogonal over the volume V with respect to the **weight function** $\rho(\mathbf{x})$, so that

$$15. \quad \int_D \rho(\mathbf{x}) U_m(\mathbf{x}) U_n(\mathbf{x}) dV = \begin{cases} 0, & m \neq n, \\ \|U_n\|^2, & m = n. \end{cases}$$

The constants C_n follow from 25.2.1.1.13 by setting $t = 0$, replacing $\phi(\mathbf{x}, t)$, by $\phi_1(\mathbf{x})$, multiplying by $U_m(x)$, integrating over D , and using 25.2.1.1.15 to obtain

$$16. \quad C_m = \frac{1}{\|U_m\|^2} \int_D \rho(\mathbf{x}) \phi_1(\mathbf{x}) U_m(\mathbf{x}) dV.$$

The constants D_m follow in similar fashion by differentiating $\phi(\mathbf{x}, t)$ with respect to t and then setting $t = 0$, replacing $\partial\phi/\partial t$ by $\phi_2(\mathbf{x})$ and proceeding as in the determination of C_m to obtain

$$17. \quad D_m = \frac{1}{\|U_m\|^2} \int_D \rho(\mathbf{x}) \phi_2(\mathbf{x}) U_m(\mathbf{x}) dV.$$

The required solution to 25.2.1.1.1 subject to the boundary condition 25.2.1.1.2 and the initial conditions 25.2.1.1.3 then follows by substituting for C_n, D_n in 25.2.1.1.13.

If in 25.2.1.1.1 the term $\rho\partial^2\phi/\partial t^2$ is replaced by $\rho\partial\phi/\partial t$ the equation becomes *parabolic*. The method of separation of variables still applies, though in place of 25.2.1.1.10, the equation governing the time variation of the solution becomes

$$18. \quad T' + \lambda T = 0,$$

and so

$$19. \quad T(t) = e^{-\lambda t}.$$

Apart from this modification, the argument leading to the solution proceeds as before.

Finally, 25.2.1.1.1 becomes elliptic if $\rho \equiv 0$, for which only an appropriate boundary condition is needed. In this case, separation of variables is only performed on the spatial variables, though the method of approach is essentially the same as the one already outlined. The boundary conditions lead first to the eigenvalues and eigenfunctions, and then to the solution.

25.3 THE STURM–LIOUVILLE PROBLEM AND SPECIAL FUNCTIONS

25.3.1

In the Sturm–Liouville problem 25.2.1.1.8, subject to the boundary condition 25.2.1.1.9, the operator $L[\phi]$ is a purely spatial operator that may involve any number of space dimensions. The coordinate system that is used determines the form of $L[\phi]$ (see 24.2.1) and the types of special functions that enter into the eigenfunctions.

To illustrate matters we consider as a representative problem 25.2.1.1.1 in cylindrical polar coordinates (r, θ, z) with $k = \text{const.}$, $\rho = \text{const.}$, and $h \equiv 0$, when the equation takes the form

$$1. \quad \frac{\partial^2\phi}{\partial r^2} + \frac{1}{r} \frac{\partial\phi}{\partial r} + \frac{1}{r^2} \frac{\partial^2\phi}{\partial\theta^2} + \frac{\partial^2\phi}{\partial z^2} = \frac{1}{c^2} \frac{\partial^2\phi}{\partial t^2},$$

where $c^2 = k/\rho$.

The first step in separating variables involves separating out the time variation by writing

$$2. \quad \phi(r, \theta, z, t) = U(r, \theta, z)T(t).$$

Substituting for ϕ in 25.3.1.1 and dividing by UT gives

$$3. \quad \frac{1}{U} \left[\frac{\partial^2 U}{\partial r^2} + \frac{1}{r} \frac{\partial U}{\partial r} + \frac{1}{r^2} \frac{\partial^2 U}{\partial \theta^2} + \frac{\partial^2 U}{\partial z^2} \right] = \frac{1}{c^2 T} \frac{d^2 T}{dt^2}.$$

Introducing a separation constant $-\lambda^2$ by setting $1/(c^2 T) d^2 T/dt^2 = -\lambda^2$ reduces 25.3.1.3 to the two differential equations

$$4. \quad \frac{d^2 T}{dt^2} + c^2 \lambda^2 T = 0 \quad (\text{time variation equation})$$

and

$$5. \quad \frac{\partial^2 U}{\partial r^2} + \frac{1}{r} \frac{\partial U}{\partial r} + \frac{1}{r^2} \frac{\partial^2 U}{\partial \theta^2} + \frac{\partial^2 U}{\partial z^2} + \lambda^2 U = 0. \quad (\text{Sturm-Liouville equation})$$

The separation constant has been chosen to be negative because solutions of wave-like equations must be oscillatory with respect to time (see 25.3.1.4).

To separate the variables in this last equation, while is the Sturm-Liouville equation, it is necessary to set

$$6. \quad U(r, \theta, z) = R(r)\Theta(\theta)Z(z)$$

and to introduce two further separation constants. However, a considerable simplification results if fewer independent variables are involved. This happens, for example, in the cylindrical polar coordinate system when the solution in planes parallel to $z = 0$ is the same, so there is no variation with z . This reduces the mathematical study of the three-dimensional problem to a two-dimensional one involving the plane polar coordinates (r, θ) . Removing the term $\partial^2 U/\partial z^2$ in the Sturm-Liouville equation reduces it to

$$7. \quad \frac{\partial^2 U}{\partial r^2} + \frac{1}{r} \frac{\partial U}{\partial r} + \frac{1}{r^2} \frac{\partial^2 U}{\partial \theta^2} + \lambda^2 U = 0.$$

To separate the variables in 25.3.1.7 we now set

$$8. \quad U(r, \theta) = R(r)\Theta(\theta),$$

substitute for U , and multiply by $r^2/(R\Theta)$ to obtain

$$9. \quad \frac{1}{R} \left(r^2 \frac{\partial^2 R}{\partial r^2} + r \frac{\partial R}{\partial r} + \lambda^2 r^2 R \right) = -\frac{1}{\Theta} \frac{d^2 \Theta}{d\theta^2},$$

where the expression on the left is a function only of r , whereas the one on the right is a function only of θ . Introducing a new separation constant μ^2 by writing $\mu^2 = -(1/\Theta) d^2 \Theta/d\theta^2$ shows that

$$10. \quad \frac{d^2 \Theta}{d\theta^2} + \mu^2 \Theta = 0$$

and

$$11. \quad r^2 \frac{d^2 R}{dr^2} + r \frac{dR}{dr} + (\lambda^2 r^2 - \mu^2) R = 0.$$

To proceed further we must make use of the boundary condition for the problem which, as yet, has not been specified. It will be sufficient to consider the solution of 25.3.1.1 in a circular cylinder of radius a with its axis coinciding with the z -axis, inside of which the solution ϕ is finite, while on its surface $\phi = 0$. Because the solution ϕ will be of the form $\phi(r, \theta, z, t) = R(r)\Theta(\theta)T(t)$, it follows directly from this that the boundary condition $\phi(a, \theta, z, t) = 0$ corresponds to the condition

$$12. \quad R(a) = 0.$$

The solution of 25.3.1.10 is

$$13. \quad \Theta(\theta) = \tilde{A} \cos \mu\theta + \tilde{B} \sin \mu\theta,$$

where \tilde{A}, \tilde{B} are arbitrary constants. Inside the cylinder $r = a$ the solution must be invariant with respect to a rotation through 2π , so that $\Theta(\theta + 2\pi) = \Theta(\theta)$, which shows that μ must be an integer $n = 0, 1, 2, \dots$. By choosing the reference line from which θ is measured 25.3.1.3 may be rewritten in the more convenient form

$$14. \quad \Theta_n(\theta) = A_n \cos n\theta.$$

The use of integer values of n in 25.3.1.11 shows the variation of the solution ϕ with r to be governed by **Bessel's equation** of integer order n

$$15. \quad r^2 \frac{d^2 R}{dr^2} + r \frac{dR}{dr} + (\lambda^2 r^2 - n^2)R = 0,$$

which has the general solution (see 17.1.1.1.8)

$$16. \quad R(r) = BJ_n(\lambda r) + CY_n(\lambda r).$$

The condition that the solution ϕ must be finite inside the cylinder requires us to set $C = 0$, because $Y_n(\lambda r)$ is infinite at the origin (see 17.2.22.2), while the condition $R(a) = 0$ in 25.3.1.12 requires that

$$17. \quad J_n(\lambda a) = 0,$$

which can only hold if λa is a zero of $J_n(x)$. Denoting the zeros of $J_n(x)$ by $j_{n,1}, j_{n,2}, \dots$ (see 17.5.11) it follows that

$$18. \quad \lambda_{n,m} = j_{n,m}/a \quad [n = 0, 1, \dots; m = 1, 2, \dots].$$

The possible spatial modes of the solution are thus described by the *eigenfunctions*

$$19. \quad U_{n,m}(r, \theta) = J_n\left(\frac{j_{n,m}r}{a}\right) \cos n\theta \quad [n = 0, 1, \dots; m = 1, 2, \dots].$$

The solution ϕ is then found by setting

$$20. \quad \phi(r, \theta, z, t) = \sum_{\substack{n=0 \\ m=1}}^{\infty} J_n\left(\frac{j_{n,m}r}{a}\right) \cos n\theta [A_{nm} \cos(\lambda_{n,m}ct) + B_{nm} \sin(\lambda_{n,m}ct)],$$

and choosing the constants A_{nm}, B_{nm} so that specified initial conditions are satisfied. In this result the multiplicative constant A_n in 25.3.1.14 has been incorporated into the arbitrary constants A_{nm}, B_{nm} introduced when 25.3.1.4 was solved.

The eigenfunctions 25.3.1.19 may be interpreted as the possible *spatial modes* of an oscillating uniform circular membrane that is clamped around its circumference $r = a$. Each term in 25.3.1.20 represents the time variation of a possible mode, with the response to specified initial conditions comprising a suitable sum of such terms.

Had 25.2.1.1 been expressed in terms of spherical polar coordinates (r, θ, ϕ) , with $k = \text{const.}$, $h \equiv 0$, and $\rho = 0$, the equation would have reduced to Laplace's equation $\nabla^2\phi = 0$. In the case where the solution is required to be finite and independent of the azimuthal angle ϕ , separation of variables would have led to eigenfunctions of the form

$$U_n(r, \theta) = Ar^n P_n(\cos \theta),$$

where $P_n(\cos \theta)$ is the *Legendre polynomial* of degree n .

Other choices of coordinate systems may lead to different and less familiar special functions, the properties of many of which are only to be found in more advanced reference works.

25.4 A FIRST-ORDER SYSTEM AND THE WAVE EQUATION

25.4.1

Although linear second-order partial differential equations govern the behavior of many physical systems, they are not the only type of equation that is of importance. In most applications that give rise to second-order equations, the equations occur as a result of the elimination of a variable, sometimes a vector, between a coupled system of more fundamental **first-order equations**. The study of such first-order systems is of importance because when variables cannot be eliminated in order to arrive at a single higher order equation the underlying first-order system itself must be solved.

A typical example of the derivation of a single second-order equation from a coupled system of first-order equations is provided by considering **Maxwell's equations** in a vacuum. These comprise a first-order linear system of the form

$$1. \quad \frac{\partial \mathbf{E}}{\partial t} = \text{curl } \mathbf{H}, \quad \frac{\partial \mathbf{H}}{\partial t} = -\text{curl } \mathbf{E}, \quad \text{with } \text{div } \mathbf{E} = 0.$$

Here $\mathbf{E} = (E_1, E_2, E_3)$ is the electric vector, $\mathbf{H} = (H_1, H_2, H_3)$ is the magnetic vector, and the third equation is the condition that no distributed charge is present.

Differentiation of the first equation with respect to t followed by substitution for $\partial \mathbf{H} / \partial t$ from the second equation leads to the following second-order vector differential equation for \mathbf{E} :

$$2. \quad \frac{\partial^2 \mathbf{E}}{\partial t^2} = -\text{curl} (\text{curl } \mathbf{E}).$$

Using vector identity 23.1.1.4 together with the condition $\operatorname{div} \mathbf{E} = 0$ shows \mathbf{E} satisfies the vector wave equation

$$3. \quad \frac{\partial^2 \mathbf{E}}{\partial t^2} = \nabla^2 \mathbf{E}.$$

The linearity of this equation then implies that each of the components of \mathbf{E} separately must satisfy this same equation, so

$$4. \quad \frac{\partial^2 U}{\partial t^2} = \nabla^2 U,$$

where U may be any component of \mathbf{E} .

An identical argument shows that the components of \mathbf{H} satisfy this same scalar wave equation. Thus the study of solutions of the first-order system involving Maxwell's equations reduces to the study of the single second-order scalar wave equation.

An example of a first-order quasilinear system of equations, the study of which cannot be reduced to the study of a single higher order equation, is provided by the equations governing **compressible gas flow**

$$5. \quad \frac{\partial \rho}{\partial t} + \operatorname{div}(\rho \mathbf{u}) = 0$$

$$6. \quad \frac{\partial \mathbf{u}}{\partial t} + \mathbf{u} \cdot \operatorname{grad} \mathbf{u} + \frac{1}{\rho} \operatorname{grad} p = 0$$

$$7. \quad p = f(\rho),$$

where ρ is the gas density, \mathbf{u} is the gas velocity, p is the gas pressure, and $f(\rho)$ is a known function of ρ (it is the **constitutive equation** relating the pressure and density). Only in the case of linear acoustics, in which the pressure variations are small enough to justify linearization of the equations, can they be reduced to the study of the scalar wave equation.

25.5 CONSERVATION EQUATIONS (LAWS)

25.5.1

A type of first-order equation that is of fundamental importance in applications is the **conservation equation**, sometimes called a **conservation law**. In the one-dimensional case let $u = u(x, t)$ represent the density per unit volume of a quantity of physical interest. Then in a cylindrical volume of cross-sectional area A normal to the x -axis and extending from $x = a$ to $x = b$, the amount present at time t is

$$1. \quad Q = A \int_a^b u(x, t) dx.$$

Let $f(x, t)$ at position x and time t be the amount of u that is flowing through a unit area normal to the x -axis per unit time. The quantity $f(x, t)$ is called the **flux** of u at position x and time t . Considering the flux at the ends of the cylindrical volume we see that

$$2. \quad Q = A[f(a, t) - f(b, t)],$$

because in a one-dimensional problem there is no flux normal to the axis of the cylinder (through the curved walls).

If there is an internal source for u distributed throughout the cylinder it is necessary to take account of its effect on u before arriving at a final *balance equation* (*conservation law*) for u . Suppose u is created (or removed) at a rate $h(x, t, u)$ at position x and time t . Then the rate of production (or removal) of u throughout the volume $= A \int_a^b h(x, t, u) dx$. Balancing all three of these results to find the rate of change of Q with respect to t gives

$$3. \quad \frac{d}{dt} \int_a^b u(x, t) dx = f(a, t) - f(b, t) + \int_a^b h(x, t, u) dx.$$

This is the **integral form of the conservation equation** for u .

Provided $u(x, t)$ and $f(x, t)$ are differentiable, this may be rewritten as

$$4. \quad \int_a^b \left[\frac{\partial u}{\partial t} + \frac{\partial f}{\partial x} - h(x, t, u) \right] dx = 0,$$

for arbitrary a and b . The result can only be true for all a and b if

$$5. \quad \frac{\partial u}{\partial t} + \frac{\partial f}{\partial x} = h(x, t, u),$$

which is the **differential equation form of the conservation equation** for u .

In more space dimensions the differential form of the conservation equation becomes the equation in **divergence form**

$$6. \quad \frac{\partial u}{\partial t} + \operatorname{div} \mathbf{f} = h(\mathbf{x}, t, u).$$

25.6 THE METHOD OF CHARACTERISTICS

25.6.1

Because the fundamental properties of first-order systems are reflected in the behavior of single first-order scalar equations, the following introductory account will be restricted to this simpler case. Consider the single first-order quasilinear equation

$$1. \quad a(x, t, u) \frac{\partial u}{\partial t} + b(x, t, u) \frac{\partial u}{\partial x} = h(x, t, u),$$

subject to the initial condition $u(x, 0) = g(x)$.

Let a curve Γ in the (x, t) -plane be defined parametrically in terms of σ by $t = t(\sigma)$, $x = x(\sigma)$. The tangent vector \mathbf{T} to Γ has components $dx/d\sigma$, $dt/d\sigma$, so the directional derivative of u with respect to σ along Γ is

$$2. \quad \frac{du}{d\sigma} = \mathbf{T} \cdot \text{grad } u = \frac{dx}{d\sigma} \frac{\partial u}{\partial x} + \frac{dt}{d\sigma} \frac{\partial u}{\partial t}.$$

Comparison of this result with the left-hand side of 25.6.1.1 shows that it may be rewritten in the **first characteristic form**

$$3. \quad \frac{du}{d\sigma} = h(x, t, u),$$

along the **characteristic curves** in the (x, t) -plane obtained by solving

$$4. \quad \frac{dt}{d\sigma} = a(x, t, u) \quad \text{and} \quad \frac{dx}{d\sigma} = b(x, t, u).$$

On occasion it is advantageous to retain the parameter σ , but it is often removed by multiplying $du/d\sigma$ and $dx/d\sigma$ by $d\sigma/dt$ to obtain the equivalent **second characteristic form** for the partial differential equation 25.6.1.1.

$$5. \quad \frac{du}{dt} = \frac{h(x, t, u)}{a(x, t, u)},$$

along the characteristic curves obtained by solving

$$6. \quad \frac{dx}{dt} = \frac{b(x, t, u)}{a(x, t, u)}.$$

This approach, called solution by the **method of characteristics**, has replaced the original partial differential equation by the solution of an ordinary differential equation that is valid along each member of the family of characteristic curves in the (x, t) -plane. If a characteristic curve C_0 intersects the initial line at $(x_0, 0)$, it follows that at this point the initial condition for u along C_0 must be $u(x_0, 0) = g(x_0)$.

This situation is illustrated in Figure 25.1, which shows typical members of a family of characteristics in the (x, t) -plane together with the specific curve C_0 .

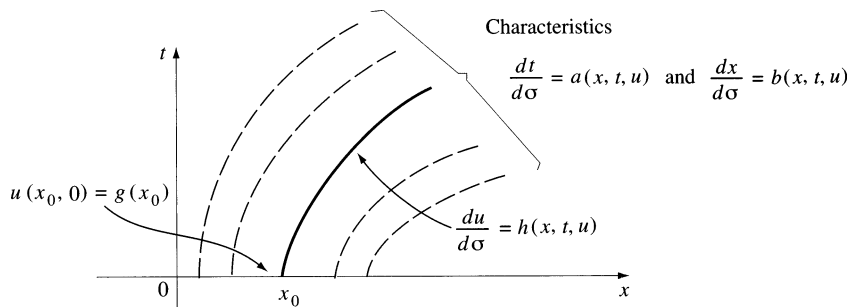

Figure 25.1.

When the partial differential equation is linear, the characteristic curves can be found independently of the solution, but in the quasilinear case they must be determined simultaneously with the solution on which they depend. This usually necessitates the use of numerical methods.

Example 25.1 This example involves a constant coefficient first-order equation. Consider the equation

$$7. \quad \frac{\partial u}{\partial t} + c \frac{\partial u}{\partial x} = 0 \quad [c > 0 \text{ a const.}],$$

sometimes called the **advection equation**, and subject to the initial condition $u(x, 0) = g(x)$. When written in the second characteristic form this becomes

$$8. \quad \frac{du}{dt} = 0$$

along the characteristic curves given by integrating $dx/dt = c$. Thus the characteristic curves are the family of parallel straight lines $x = ct + \xi$ that intersects the initial line $t = 0$ (the x -axis) at the point $(\xi, 0)$. The first equation shows that $u = \text{const.}$ along a characteristic, but at the point $(\xi, 0)$ we have $u(\xi, 0) = g(\xi)$, so $u(x, t) = g(\xi)$ along this characteristic. Using the fact that $\xi = x - ct$ it then follows that the required solution is

$$9. \quad u(x, t) = g(x - ct).$$

The solution represents a **traveling wave** with initial shape $g(x)$ that moves to the right with constant speed c without change of shape. The nature of the solution relative to the characteristics is illustrated in Figure 25.2.

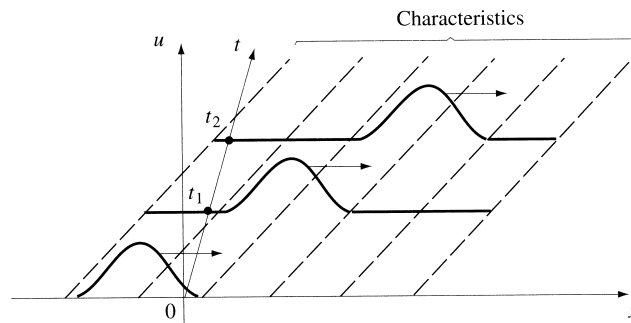

Figure 25.2.

Example 25.2 In this example we solve the linear variable coefficient first-order equation

$$10. \quad \frac{\partial u}{\partial t} + t \frac{\partial u}{\partial x} = xt,$$

subject to the initial condition $u(x, 0) = \sin x$. Again expressing the equation in the second characteristic form gives

$$11. \quad \frac{du}{dt} = xt$$

along the characteristics given by integrating $dx/dt = t$. Integration shows that the characteristic curves are

$$12. \quad \int dx = \int t dt \quad \text{or} \quad x = \frac{1}{2}t^2 + \xi,$$

where the constant of integration ξ defines point $(\xi, 0)$ on the initial line through which the characteristic curve passes, while from the initial condition $u(\xi, 0) = \sin \xi$.

Substituting for x in $du/dt = xt$ and integrating gives

$$13. \quad \int du = \int \left(\frac{1}{2}t^3 + \xi t \right) dt \quad \text{or} \quad u = \frac{1}{8}t^4 + \frac{1}{2}\xi t^2 + k(\xi),$$

where for the moment the “constant of integration” $k(\xi)$ is an unknown function of ξ . The function $k(\xi)$ is constant along each characteristic, but it differs from characteristic to characteristic, depending on the value of ξ associated with each characteristic.

Because $\xi = x - \frac{1}{2}t^2$, it follows that

$$14. \quad u(x, t) = \frac{1}{8}t^4 + \frac{1}{2} \left(x - \frac{1}{2}t^2 \right) t^2 + k \left(x - \frac{1}{2}t^2 \right).$$

Setting $t = 0$ and using the initial condition $u(x, 0) = \sin x$ reduces this last result to

$$15. \quad \sin x = k(x),$$

so the unknown function k has been determined. Replacing x in $k(x)$ by $x - \frac{1}{2}t^2$, and using the result in the expression for $u(x, t)$ gives

$$16. \quad u(x, t) = \frac{1}{8}t^4 + \frac{1}{2} \left(x - \frac{1}{2}t^2 \right) t^2 + \sin \left(x - \frac{1}{2}t^2 \right).$$

This expression for $u(x, t)$ satisfies the initial condition and the differential equation, so it is the required solution.

Example 25.3 This example involves a simple first-order quasilinear equation. We now use the method of characteristics to solve the initial value problem

$$17. \quad \frac{\partial u}{\partial t} + f(u) \frac{\partial u}{\partial x} = 0,$$

subject to the initial condition $u(x, 0) = g(x)$, where $f(u)$ and $g(x)$ are known continuous and differentiable functions.

Proceeding as before, the second characteristic form for the equation becomes

$$18. \quad \frac{du}{dt} = 0$$

along the characteristic curves given by integrating $dx/dt = f(u)$. The first equation shows $u = \text{constant}$ along a characteristic curve. Using this result in the second equation and integrating shows the characteristic curves to be the family of straight lines

$$19. \quad x = t f(u) + \xi,$$

where $(\xi, 0)$ is the point on the initial line from which the characteristic emanates. From the initial condition it follows that the value of u transported along this characteristic must be $u = g(\xi)$. Because $\xi = x - t f(u)$, it follows that the solution is given *implicitly* by

$$20. \quad u(x, t) = g[x - t f(u)].$$

The implicit nature of this solution indicates that the solution need not necessarily always be unique. This can also be seen by computing $\partial u / \partial x$, which is

$$21. \quad \frac{\partial u}{\partial x} = \frac{g'(x - t f(u))}{1 + t g'(x - t f(u)) f'(u)}.$$

If the functions f and g are such that the denominator vanishes for some $t = t_c > 0$, the derivative $\partial u / \partial x$ becomes unbounded when $t = t_c$. When this occurs, the differential equation can no longer govern the behavior of the solution, so it ceases to have meaning and the solution may become nonunique.

The development of the solution when $f(u) = u$ and $g(x) = \sin x$ is shown in Figure 25.3. The wave profile is seen to become steeper due to the influence of nonlinearity until $t = t_c$, where the tangent to part of the solution profile becomes infinite. Subsequent to time t_c the solution is seen to become many valued (nonunique). This result illustrates that, unlike the linear case in which $f(u) = c$ (const.), a quasilinear equation of this type cannot describe traveling waves of constant shape.

25.7 DISCONTINUOUS SOLUTIONS (SHOCKS)

25.7.1

To examine the nature of **discontinuous solutions** of first-order quasilinear hyperbolic equations, it is sufficient to consider the scalar conservation equation in differential form

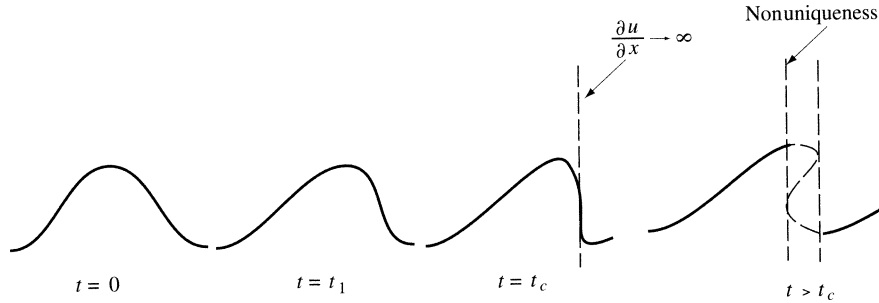

Figure 25.3.

1. $\frac{\partial u}{\partial t} + \text{div } \mathbf{f} = 0,$

where $u = u(\mathbf{x}, t)$ and $\mathbf{f} = \mathbf{f}(u)$. Let $V(t)$ be an arbitrary volume bounded by a surface $S(t)$ moving with velocity $\boldsymbol{\nu}$. Provided u is differentiable in $V(t)$, it follows from 23.11.1.1 that the rate of change of the volume integral of u is

2. $\frac{d}{dt} \int_{V(t)} u \, dV = \int_{V(t)} \left\{ \frac{\partial u}{\partial t} + \text{div}(u\boldsymbol{\nu}) \right\} dV.$

Substituting for $\partial u/\partial t$ gives

3. $\frac{d}{dt} \int_{V(t)} u \, dV = \int_{V(t)} [\text{div}(u\boldsymbol{\nu}) - \text{div } \mathbf{f}] \, dV,$

and after use of the Gauss divergence theorem 23.9.1.3 this becomes

4. $\frac{d}{dt} \int_{V(t)} u \, dV = \int_{S(t)} (u\boldsymbol{\nu} - \mathbf{f}) \cdot d\boldsymbol{\sigma},$

where $d\boldsymbol{\sigma}$ is the outward drawn vector element of surface area of $S(t)$ with respect to $V(t)$.

Now suppose that $V(t)$ is divided into two parts $V_1(t)$ and $V_2(t)$ by a moving surface $\boldsymbol{\Omega}(t)$ across which u is discontinuous, with $u = u_1$ in $V_1(t)$ and $u = u_2$ in $V_2(t)$. Subtracting from this last result the corresponding results when $V(t)$ is replaced first by $V_1(t)$ and then by $V_2(t)$ gives

5. $0 = \int_{\boldsymbol{\Omega}(t)} (u\boldsymbol{\nu} - \mathbf{f})_1 \cdot d\boldsymbol{\Omega}_1 + \int_{\boldsymbol{\Omega}(t)} (u\boldsymbol{\nu} - \mathbf{f})_2 \cdot d\boldsymbol{\Omega}_2,$

where now $\boldsymbol{\nu}$ is restricted to $\boldsymbol{\Omega}(t)$, and so is the velocity of the discontinuity surface, while $d\boldsymbol{\Omega}_i$ is the outwardly directed vector element of surface area of $\boldsymbol{\Omega}(t)$ with respect to $V_i(t)$ for

$i = 1, 2$. As $d\Omega_1 = -d\Omega_2 = \mathbf{n}d\Omega$, say, where \mathbf{n} is the outward drawn unit normal to $\Omega_1(t)$ with respect to $V_1(t)$, it follows that

$$6. \quad 0 = \int_{\Omega(t)} [(u\boldsymbol{\nu} - \mathbf{f})_1 \cdot \mathbf{n} - (u\boldsymbol{\nu} - \mathbf{f})_2 \cdot \mathbf{n}] d\Omega = 0.$$

The arbitrariness of $V(t)$ implies that this result must be true for all $\Omega(t)$, which can only be possible if

$$7. \quad (u\boldsymbol{\nu} - \mathbf{f})_1 \cdot \mathbf{n} = (u\boldsymbol{\nu} - \mathbf{f})_2 \cdot \mathbf{n}.$$

The speed of the discontinuity surface along the normal \mathbf{n} is the same on either side of $\Omega(t)$, so setting $\boldsymbol{\nu}_1 \cdot \mathbf{n} = \boldsymbol{\nu}_2 \cdot \mathbf{n} = s$, leads to the following **algebraic jump condition** that must be satisfied by a discontinuous solution

$$8. \quad (u_1 - u_2)s = (\mathbf{f}_1 - \mathbf{f}_2) \cdot \mathbf{n}.$$

This may be written more concisely as

$$9. \quad \llbracket u \rrbracket s = \llbracket \mathbf{f} \rrbracket \cdot \mathbf{n},$$

where $\llbracket \alpha \rrbracket = \alpha_1 - \alpha_2$ denotes the jump in α across $\Omega(t)$.

In general, $\mathbf{f} = \mathbf{f}(u)$ is a *nonlinear* function of u , so for any given s , specifying u on one side of the discontinuity and using the jump condition to find u on the other side may lead to more than one value. This possible nonuniqueness of discontinuous solutions to quasilinear hyperbolic equations is typical, and in physical problems a *criterion (selection principle)* must be developed to select the unique physically realizable discontinuous solution from among the set of all mathematically possible but nonphysical solutions.

In gas dynamics the jump condition is called the **Rankine–Hugoniot jump condition**, and a discontinuous solution in which gas flows across the discontinuity is called a **shock**, or a **shock wave**. In the case in which a discontinuity is present, but there is no gas flow across it, the discontinuity is called a **contact discontinuity**. In gas dynamics two shocks are possible mathematically, but one is rejected as nonphysical by appeal to the second law of thermodynamics (the selection principle used there) because of the entropy decrease that occurs across it, so only the compression shock that remains is a physically realizable shock. To discuss discontinuous solutions, in general it is necessary to introduce more abstract selection principles, called **entropy conditions**, which amount to stability criteria that must be satisfied by solutions.

The need to work with conservation equations (equations in divergence form) when considering discontinuous solutions can be seen from the preceding argument, for only then can the Gauss divergence theorem be used to relate the solution on one side of the discontinuity to that on the other.

25.8 SIMILARITY SOLUTIONS

25.8.1

When *characteristic scales* exist for length, time, and the dependent variables in a physical problem it is advantageous to free the equations from dependence on a particular choice of scales by expressing them in nondimensional form. Consider, for example, a cylinder of radius ρ_0 filled with a viscous fluid with viscosity ν , which is initially at rest at time $t = 0$. This cylinder is suddenly set into rotation about the axis of the cylinder with angular velocity ω . Although this is a three-dimensional problem, because of radial symmetry about the axis, the velocity \mathbf{u} at any point in the fluid can only depend on the radius ρ and the time t if gravity is neglected.

Natural length and time scales are ρ_0 , which is determined by the geometry of the problem, and the period of a rotation $\tau = 2\pi/\omega$, which is determined by the initial condition. Appropriate nondimensional length and time scales are thus $r = \rho/\rho_0$ and $T = t/\tau$. The dependent variable in the problem is the fluid velocity $\mathbf{u}(r, t)$, which can be made nondimensional by selecting as a convenient characteristic speed $u_0 = \omega\rho_0$, which is the speed of rotation at the wall of the cylinder. Thus, an appropriate nondimensional velocity is $U = u/u_0$.

The only other quantity that remains to be made nondimensional is the viscosity ν . It proves most convenient to work with $1/\nu$ and to define the **Reynolds number** $\text{Re} = u_0\rho_0/\nu$, which is a dimensionless quantity. Once the governing equation has been reexpressed in terms of r , T , U , and Re , and its dimensionless solution has been found, the result may be used to provide the solution appropriate to any choice of ρ_0 , ω , and ν for which the governing equations are valid.

Equations that have natural characteristic scales for the independent variables are said to be **scale-similar**. The name arises from the fact that any two different problems with the same numerical values for the dimensionless quantities involved will have the same nondimensional solution.

Certain partial differential equations have no natural characteristic scales for the independent variables. These are equations for which **self-similar** solutions can be found. In such problems the nondimensionalization is obtained not by introducing characteristic scales, but by combining the independent variables into *nondimensional groups*.

The classic example of a self-similar solution is provided by considering the unsteady heat equation

$$1. \quad \frac{\partial^2 T}{\partial x^2} = \frac{1}{\kappa} \frac{\partial T}{\partial t}$$

applied to a semi-infinite slab of heat conducting material with thermal diffusivity κ , with x measured into the slab normal to the bounding face $x = 0$. Suppose that for $t < 0$ the material is all at the initial temperature T_0 , and that at $t = 0$ the temperature of the face of the slab is suddenly changed to T_1 . Then there is a natural characteristic temperature scale provided by the temperature difference $T_1 - T_0$, so a convenient nondimensional temperature is $\tau = (T - T_0)/(T_1 - T_0)$. However, in this example, no natural length and time scales can be introduced.

If a combination η , say, of variables x and t is to be introduced in place of the separate variables x and t themselves, the one-dimensional heat equation will be simplified if this change of variable reduces it to a second-order ordinary differential equation in terms of the single independent variable η . The consequence of this approach will be that instead of there being a different temperature profile for each time t , there will be a single profile in terms of η from which the temperature profile at any time t can be deduced. It is this scaling of the solution on itself that gives rise to the name *self-similar solution*.

Let us try setting

$$2. \quad \eta = Dx/t^n \quad \text{and} \quad \tau = f(\eta) \quad [D = \text{const.}]$$

in the heat equation, where a suitable choice for n has still to be made. Routine calculation shows that the heat equation becomes

$$3. \quad \frac{d^2 f}{d\eta^2} + \frac{n}{\kappa D^2} t^{2n-1} \eta \frac{df}{d\eta} = 0.$$

For this to become an ordinary differential equation in terms of the independent variable η , it is necessary for the equation to be independent of t , which may be accomplished by setting $n = \frac{1}{2}$ to obtain

$$4. \quad \frac{d^2 f}{d\eta^2} + \frac{1}{2\kappa D^2} \eta \frac{df}{d\eta} = 0.$$

It is convenient to choose D so that $2\kappa D^2 = 1$, which corresponds to

$$5. \quad D = 1/\sqrt{2\kappa}.$$

The heat equation then reduces to the variable coefficient second-order ordinary differential equation

$$6. \quad \frac{d^2 f}{d\eta^2} + \eta \frac{df}{d\eta} = 0, \quad \text{with } \eta = x/\sqrt{2\kappa t}.$$

The initial condition shows that $f(0) = 1$, while the temperature variation must be such that for all time t , $T \rightarrow T_0$ as $\eta \rightarrow \infty$, so another condition on f is $f(\eta) \rightarrow 0$ as $\eta \rightarrow \infty$. Integration of the equation for f subject to these conditions can be shown to lead to the result

$$7. \quad T = T_0 + (T_1 - T_0) \operatorname{erfc}\left(\frac{x}{2\sqrt{\kappa t}}\right).$$

Sophisticated group theoretic arguments must be used to find the similarity variable in more complicated cases. However, this example illustrates the considerable advantage of this approach when a similarity variable can be found, because it reduces by one the number of independent variables involved in the partial differential equation.

As a final simple example of self-similar solutions, we mention the *cylindrical wave equation*

$$8. \quad \frac{\partial^2 \Phi}{\partial r^2} + \frac{1}{r} \frac{\partial \Phi}{\partial r} = \frac{1}{c^2} \frac{\partial^2 \Phi}{\partial t^2},$$

which has the self-similar solution

$$9. \quad \Phi(r, t) = rf(\eta), \quad \text{with } \eta = \frac{r}{ct},$$

where f is a solution of the ordinary differential equation

$$10. \quad \eta(1 - \eta^2)f''(\eta) + (3 - 2\eta^2)f' + f/\eta = 0.$$

If the wave equation is considered to describe an expanding cylindrically symmetric wave, the radial speed of the wave v_r can be shown to be

$$11. \quad v_r = -[f(\eta) + \eta f'(\eta)],$$

which in turn can be reduced to

$$12. \quad v_r = \begin{cases} A(1 - \eta^2)/\eta, & \eta \leq 1, \\ 0, & \eta > 1, \end{cases}$$

where A is a constant of integration.

Other solutions of 25.8.1.8 can be found if appeal is made to the fact that solutions are invariant with respect to a time translation, so that in the solution t may be replaced by $t - t^*$, for some constant t^* .

Result 25.8.1.12 then becomes

$$13. \quad v_r = \begin{cases} A(t^*)[c^2(t - t^*)^2 - r^2]^{1/2}/r, & t^* \leq t - r/c, \\ 0, & t^* > t - r/c, \end{cases}$$

and different choices for $A(t^*)$ will generate different solutions.

25.9 BURGERS'S EQUATION, THE KdV EQUATION, AND THE KdVB EQUATION

25.9.1

In time-dependent partial differential equations, certain higher order spatial derivatives are capable of interpretation in terms of important physical effects. For example, in **Burgers's equation**

$$1. \quad \frac{\partial u}{\partial t} + u \frac{\partial u}{\partial x} = \nu \frac{\partial^2 u}{\partial x^2} \quad [\nu > 0].$$

the term on the right may be interpreted as a **dissipative** effect; namely, as the removal of energy from the system described by the equation. In the **Korteweg-de Vries (KdV) equation**

$$2. \quad \frac{\partial u}{\partial t} + u \frac{\partial u}{\partial x} + \mu \frac{\partial^3 u}{\partial x^3} = 0,$$

the last term on the left represents a **dispersive** effect; namely, a smoothing effect that causes localized disturbances in waves that are propagated to spread out and disperse.

Burgers's equation serves to model a gas shock wave in which energy dissipation is present ($\nu > 0$). The steepening effect of nonlinearity in the second term on the left can be balanced by the dissipative effect, leading to a traveling wave of constant form, unlike the case examined earlier corresponding to $\nu = 0$ in which a smooth initial condition evolved into a discontinuous solution (shock). The steady traveling wave solution for Burgers's equation that describes the so-called **Burgers's shock wave** is

$$3. \quad u(\zeta) = \frac{1}{2}(u_{\infty}^- + u_{\infty}^+) - \frac{1}{2}(u_{\infty}^- - u_{\infty}^+) \tanh \left[\left(\frac{u_{\infty}^- - u_{\infty}^+}{4\nu} \right) \zeta \right],$$

where $\zeta = x - ct$, with the speed of propagation $c = \frac{1}{2}(u_{\infty}^- + u_{\infty}^+)$, $u_{\infty}^- > u_{\infty}^+$, and u_{∞}^- and u_{∞}^+ denote, respectively, the solutions at $\zeta \rightarrow -\infty$ and $\zeta \rightarrow +\infty$. This describes a smooth transition from u_{∞}^- to u_{∞}^+ . The Burgers's shock wave profile is shown in Figure 25.4.

The celebrated KdV equation was first introduced to describe the propagation of long waves in shallow water, but it has subsequently been shown to govern the asymptotic behavior of many other physical phenomena in which nonlinearity and dispersion compete. In the KdV equation, the smoothing effect of the dispersive term can balance the steepening effect of the nonlinearity in the second term to lead to a traveling wave of constant shape in the form of

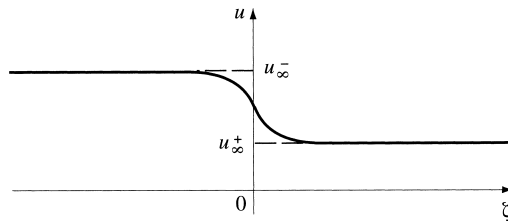

Figure 25.4.

a pulse called a **solitary wave**. The solution for the KdV solitary wave in which $u \rightarrow u_\infty$ as $\zeta \rightarrow \pm \infty$ is

$$4. \quad u(\zeta) = u_\infty + a \operatorname{sech}^2 \left[\zeta \left(\frac{a}{12\mu} \right)^{1/2} \right] \quad [u_\infty > 0],$$

where $\zeta = x - ct$, with the speed of propagation $c = u_\infty + \frac{1}{3}a$.

Notice that, relative to u_∞ , the speed of propagation of the solitary wave is proportional to the amplitude a . It has been shown that these solitary wave solutions of the KdV equation have the remarkable property that, although they are solutions of a nonlinear equation, they can *interact and preserve their identity* in ways that are similar to those of linear waves. However, unlike linear waves, during the interaction the solutions are *not* additive, though after it they have interchanged their positions. This property has led to these waves being called **solitons**. Interaction between two solitons occurs when the amplitude of the one on the left exceeds that of the one on the right, for then overtaking takes place due to the speed of the one on the left being greater than the speed of the one on the right. This interaction is illustrated in Figure 25.5; the waves are *unidirectional* since only a first-order time derivative is present in the KdV equation.

The Korteweg–de Vries–Burgers's (KdVB) equation

$$5. \quad \frac{\partial u}{\partial t} + u \frac{\partial u}{\partial x} - \nu \frac{\partial^2 u}{\partial x^2} + \mu \frac{\partial^3 u}{\partial x^3} = 0 \quad [\nu > 0],$$

describes wave propagation in which the effects of nonlinearity, dissipation, and dispersion are all present. In steady wave propagation the combined smoothing effects of dissipation and dispersion can balance the steepening effect of nonlinearity and lead to a traveling wave solution moving to the right given by

$$6. \quad u(\zeta) = \frac{3\nu^2}{100\mu} [\operatorname{sech}^2(\zeta/2) + 2 \tanh(\zeta/2) + 2],$$

with

$$7. \quad \zeta = \frac{-\nu}{5\mu} \left(x - \frac{6\nu^2}{25\mu} t \right) \quad \text{and} \quad \text{speed } c = 6\nu^2/(25\mu),$$

or to one moving to the left given by

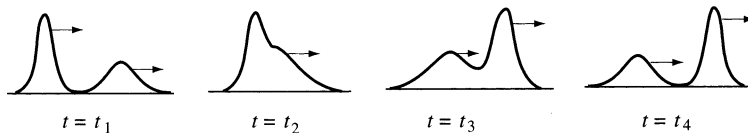

Figure 25.5.

$$8. \quad u(\zeta) = \frac{3\nu^2}{100\mu} [\operatorname{sech}^2(\zeta/2) - 2 \tanh(\zeta/2) - 2],$$

with

$$9. \quad \zeta = \frac{\nu}{5\mu} \left(x + \frac{6\nu^2}{25\mu} t \right) \quad \text{and} \quad \text{speed } c = -6\nu^2/(25\mu).$$

The wave profile for a KdVB traveling wave is very similar to that of the Burgers's shock wave.

25.10 THE POISSON INTEGRAL FORMULAS

There are two fundamental boundary value problems for a solution u of the Laplace equation in the plane that can be expressed in terms of integrals. The first involves finding the solution (a harmonic function) in the upper half of the (x, y) -plane when Dirichlet conditions are imposed on the x -axis. The second involves finding the solution (a harmonic function) inside a circle of radius R centered on the origin when Dirichlet conditions are imposed on the boundary of the circle. The two results are called the **Poisson integral formulas** for solutions of the Laplace equation in the plane, and they take the following forms:

The Poisson integral formula for the half-plane

Let $f(x)$ be a real valued function that is bounded and may be either continuous or piecewise continuous for $-\infty < x < \infty$. Then, when the integral exists, the function

$$1. \quad u(x, y) = \frac{y}{\pi} \int_{-\infty}^{\infty} \frac{f(s) ds}{(x-s)^2 + y^2}$$

is harmonic in the half-plane $y > 0$ and on the x -axis assumes the boundary condition $u(x, 0) = f(x)$ wherever $f(x)$ is continuous.

The Poisson integral formula for a disk

Let $f(\theta)$ be a real valued function that is bounded and may be either continuous or piecewise continuous for $-\pi < \theta \leq \pi$. Then, when the integral exists, the function

$$2. \quad u(r, \theta) = \frac{1}{2\pi} \int_0^{2\pi} \frac{(R^2 - r^2) f(\psi) d\psi}{R^2 - 2rR \cos(\psi - \theta) + r^2}$$

is harmonic inside the disk $0 \leq r < R$, and on the boundary of the disk $r = R$, it assumes the boundary condition $u(R, \theta) = f(\theta)$ wherever $f(\theta)$ is continuous.

These integrals have many applications, and they are often used in conjunction with conformal mapping when a region of complicated shape is mapped either onto a half-plane or onto a disk when these formulas will give the solution. However, unless the boundary conditions are simple, the integrals may be difficult to evaluate, though they may always be used to provide numerical results.

Example 25.4 Find the harmonic function u in the half-plane $y > 0$ when $u(x, 0) = -1$ for $-\infty < x < 0$ and $u(x, 0) = 1$ for $0 < x < \infty$.

Setting $f(x) = -1$ for $-\infty < x < 0$ and $f(x) = 1$ for $0 < x < \infty$ in formula 1 and integrating gives

$$u(x, y) = -\frac{1}{2} \frac{(\pi - 2 \arctan(x/y))}{\pi} \text{ for } -\infty < x < 0$$

and

$$u(x, y) = \frac{1}{2} \frac{(\pi + 2 \arctan(x/y))}{\pi} \text{ for } 0 < x < \infty.$$

Notice that in this case the boundary condition $f(x)$ is discontinuous at the origin. These solutions do not assign a value for u at the origin, but this is to be expected because none exists, and as the results are derived from formula 1 on the assumption that $y \neq 0$, the formula vanishes when $y = 0$.

Example 25.5 Find the harmonic function u inside the unit disk centered on the origin when on its boundary $u(1, \theta) = \sin^2 \theta$.

Setting $R = 1$ and $f(\theta) = \sin^2 \theta$ in formula 2 leads to the integrand $\frac{(1 - r^2) \sin^2 \psi}{1 - 2r \cos(\psi - \theta) + r^2}$.

The change of variable to $z = e^{i\psi}$ converts the integral into a complex integral with a pole of order 2 and also a simple pole inside the unit circle. An application of the residue theorem then shows the required solution to be $u(r, \theta) = \frac{1}{2}(1 - r^2 \cos 2\theta)$.

25.11 THE RIEMANN METHOD

The **Riemann method of solution** applies to linear hyperbolic equations when Cauchy conditions are prescribed along a finite arc Γ_{QR} in the (x, y) -plane. It gives the solution $u(x_0, y_0)$ at an arbitrary point (x_0, y_0) in terms of an integral representation involving a function $v(x, y; x_0, y_0)$ called the **Riemann function**, where $u(x, y)$ satisfies the equation

$$1. \quad \frac{\partial^2 u}{\partial x \partial y} + a(x, y) \frac{\partial u}{\partial x} + b(x, y) \frac{\partial u}{\partial y} + c(x, y)u = f(x, y).$$

In this representation x_0 and y_0 are considered to be parameters of a point P in the (x, y) -plane at which the solution is required, and their relationships to the points Q and R are shown in Figure 25.6.

The Riemann function v is a solution of the homogeneous adjoint equation associated with 1

$$2. \quad \frac{\partial^2 v}{\partial x \partial y} - \frac{\partial(av)}{\partial x} - \frac{\partial(bv)}{\partial y} + cv = 0,$$

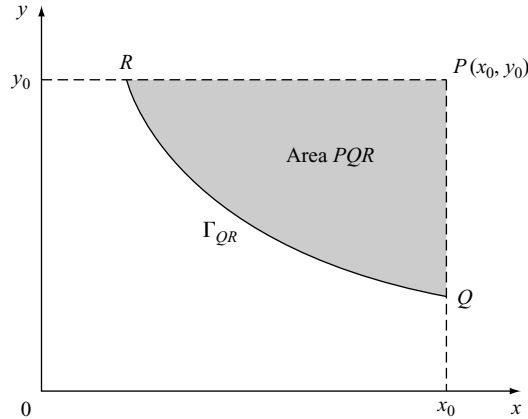

Figure 25.6. Points P , Q , and R and the arc Γ_{QR} along which the Cauchy conditions for u are specified.

subject to the conditions

$$3. \quad v(x, \eta; x_0, y_0) = \exp\left(\int_{x_0}^x b(\sigma, y_0) d\sigma\right) \quad \text{and} \quad v(x_0, y; x_0, y_0) = \exp\left(\int_{y_0}^y a(x_0, \sigma) d\sigma\right)$$

When equation 1 is written as $L[u] = f(x, y)$ and equation 2 as $M[v] = 0$, equation 1 will be **self-adjoint** when the operators L and M are such that $L \equiv M$. In general, solving the adjoint equation for v is as difficult as solving the original equation for u , so a significant simplification results when the equation is self-adjoint.

The Riemann integral formula for the solution $u(x_0, y_0)$ at a point P in the (x, y) -plane terms of the Riemann function v is

$$4. \quad u(x_0, y_0) = \frac{1}{2}(uv)_R + \frac{1}{2}(uv)_Q + \iint_{PQR} Fv dx dy \\ - \int_{\Gamma_{QR}} \left[buv + \frac{1}{2}(vu_x - uv_x) \right] dx - \left[av + \frac{1}{2}(vu_y - uv_y) \right] dy,$$

where $\iint_{PQR} Fv dx dy$ denotes the integral over the region PQR .

This method only gives closed form solutions when the equations involved are simple, so its main use is in deriving information about domains of dependence and influence for equation 1 of a rather general type.

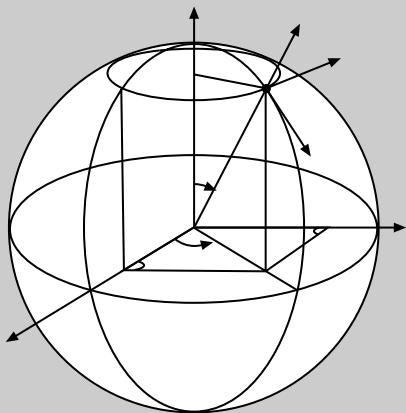

Chapter 26

Qualitative Properties of the Heat and Laplace Equation

26.1 THE WEAK MAXIMUM/MINIMUM PRINCIPLE FOR THE HEAT EQUATION

Let $u(x, t)$ satisfy the heat (diffusion) equation

$$u_t = k^2 u_{xx}$$

in the space-time rectangle $0 \leq x \leq L$, $0 \leq t \leq T$. Then the maximum value of $u(x, t)$ occurs either initially when $t = 0$, or on the sides of the rectangle $x = 0$ or $x = L$ for $0 \leq t \leq T$. Similarly, the minimum value of $u(x, t)$ occurs either initially when $t = 0$, or on the sides of the rectangle $x = 0$ or $x = L$ for $0 \leq t \leq T$.

26.2 THE MAXIMUM/MINIMUM PRINCIPLE FOR THE LAPLACE EQUATION

Let D be a connected bounded open region in two or three space dimensions, and let the function u be harmonic and continuous throughout D and on its boundary ∂D . Then if u is not constant it attains its maximum and minimum values only on the boundary ∂D .

26.3 GAUSS MEAN VALUE THEOREM FOR HARMONIC FUNCTIONS IN THE PLANE

If u is harmonic in a region D of the plane, the value of u at any interior point P of D is the average of the values of u around any circle centered on P and lying entirely inside D .

26.4 GAUSS MEAN VALUE THEOREM FOR HARMONIC FUNCTIONS IN SPACE

If u is harmonic in a region D of space, the value of u at any interior point P of D is the average of the values of u around the surface of any sphere centered on P and lying entirely inside D .

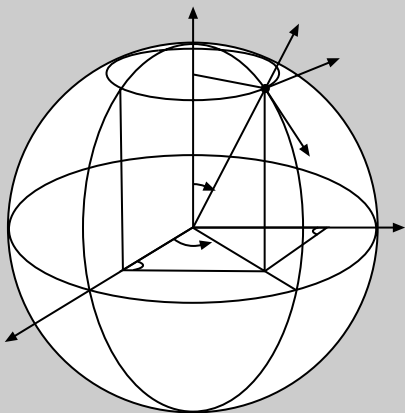

Chapter 27

Solutions of Elliptic, Parabolic, and Hyperbolic Equations

The standard solutions of the Laplace, heat (diffusion), and wave equation that follow are expressed in terms of eigenfunction expansions obtained by the method of **separation of variables** described in Section 25.2.1.

27.1 ELLIPTIC EQUATIONS (THE LAPLACE EQUATION)

1. The boundary value problem:

$$u_{xx}(x, y) + u_{yy}(x, y) = 0, \quad \text{in the rectangle } 0 < x < a, 0 < y < b,$$

subject to the four Dirichlet boundary conditions

$$u(0, y) = 0, \quad u(a, y) = 0, \quad 0 < y < b,$$

$$u(x, 0) = f(x), \quad u(x, b) = 0, \quad 0 < x < a.$$

Solution

$$u(x, y) = \sum_{n=1}^{\infty} c_n \sinh\left(\frac{n\pi(b-y)}{a}\right) \sin\left(\frac{n\pi x}{a}\right),$$

with

$$c_n = \frac{2}{a \sinh(n\pi b/a)} \int_0^a f(x) \sin\left(\frac{n\pi x}{a}\right) dx.$$

2. The boundary value problem:

$$u_{xx}(x, y) + u_{yy}(x, y) = 0, \quad \text{in the rectangle } 0 < x < a, 0 < y < b,$$

subject to the two Dirichlet boundary conditions

$$u(x, 0) = 0, \quad u(x, b) = f(x) \quad \text{for } 0 < x < a,$$

and the two Neumann conditions

$$u_x(0, y) = 0, \quad u_x(a, y) = 0 \quad \text{for } 0 < y < b.$$

Solution

$$u(x, y) = c_0 y + \sum_{n=1}^{\infty} c_n \sinh\left(\frac{n\pi y}{a}\right) \cos\left(\frac{n\pi x}{a}\right),$$

with

$$c_n = \frac{2}{a \sinh(n\pi b/a)} \int_0^a f(x) \cos\left(\frac{n\pi x}{a}\right) dx.$$

3. The boundary value problem:

$$u_{xx}(x, y) + u_{yy}(x, y) = 0, \quad \text{in the semi-infinite strip } x > 0, 0 < y < b,$$

subject to the four Dirichlet boundary conditions

$$u(x, 0) = 0, \quad u(x, b) = 0 \quad \text{for } x > 0,$$

$$u(0, y) = U(\text{constant}) \quad \text{for } 0 < y < b, \quad \text{and } u(x, y) \text{ finite as } x \rightarrow \infty.$$

Solution

$$u(x, y) = \frac{2U}{\pi} \arctan\left(\frac{\sin(\pi y/b)}{\sinh(\pi x/b)}\right).$$

4. The boundary value problem:

$$r^2 u_{rr}(r, \theta) + r u_r(r, \theta) + u_{\theta\theta}(r, \theta) = 0,$$

with $u(r, \theta)$, in polar coordinates, *inside* a circle of radius R subject to the Dirichlet boundary condition on the circumference

$$u(R, \theta) = f(\theta), \quad \text{for } 0 < \theta \leq 2\pi.$$

Solution

$$u(r, \theta) = \frac{1}{2}a_0 + \sum_{n=1}^{\infty} \left(\frac{r}{R}\right)^n (a_n \cos n\theta + b_n \sin n\theta),$$

with $r < R$ and

$$a_n = \frac{1}{\pi} \int_0^{2\pi} f(\theta) \cos n\theta \, d\theta, \quad n = 0, 1, \dots,$$

$$b_n = \frac{1}{\pi} \int_0^{2\pi} f(\theta) \sin n\theta \, d\theta, \quad n = 1, 2, \dots$$

5. The boundary value problem:

$$r^2 u_{rr}(r, \theta) + r u_r(r, \theta) + u_{\theta\theta}(r, \theta) = 0,$$

with $u(r, \theta)$, in polar coordinates, *outside* a circle of radius R subject to the Dirichlet boundary condition on the circumference

$$u(R, \theta) = f(\theta), \quad \text{for } 0 < \theta \leq 2\pi.$$

Solution

$$u(r, \theta) = \frac{1}{2}a_0 + \sum_{n=1}^{\infty} \left(\frac{R}{r}\right)^n (a_n \cos n\theta + b_n \sin n\theta),$$

with $r > R$ and

$$a_n = \frac{1}{\pi} \int_0^{2\pi} f(\theta) \cos n\theta \, d\theta, \quad n = 0, 1, \dots,$$

$$b_n = \frac{1}{\pi} \int_0^{2\pi} f(\theta) \sin n\theta \, d\theta, \quad n = 1, 2, \dots$$

6. The boundary value problem:

$$r^2 u_{rr}(r, \theta) + r u_r(r, \theta) + u_{\theta\theta}(r, \theta) = 0,$$

with $u(r, \theta)$, in polar coordinates, *inside* a circle of radius R subject to the Neumann boundary condition on the circumference $u_r(R, \theta) = f(\theta)$, and satisfying the condition $\int_0^{2\pi} f(\theta) \, d\theta = 0$ necessary for the existence of a solution.

Solution

$$u(r, \theta) = \sum_{n=1}^{\infty} \left(\frac{r^n}{nR^{n-1}}\right) (a_n \cos n\theta + b_n \sin n\theta) + C,$$

with $r < R, C$ an arbitrary constant, and

$$a_n = \frac{1}{\pi} \int_0^{2\pi} f(\theta) \cos n\theta \, d\theta, \quad n = 1, 2, \dots,$$

$$b_n = \frac{1}{\pi} \int_0^{2\pi} f(\theta) \sin n\theta \, d\theta, \quad n = 1, 2, \dots$$

7. The boundary value problem:

$$r^2 u_{rr}(r, \theta) + r u_r(r, \theta) + u_{\theta\theta}(r, \theta) = 0,$$

with $u(r, \theta)$, in polar coordinates, *outside* a circle of radius R subject to the Neumann boundary condition on the circumference $u_r(R, \theta) = f(\theta)$, and satisfying the condition $\int_0^{2\pi} f(\theta) \, d\theta = 0$, necessary for the existence of a solution.

Solution

$$u(r, \theta) = \sum_{n=1}^{\infty} \left(\frac{R^{n+1}}{nr^n} \right) (a_n \cos n\theta + b_n \sin n\theta) + C,$$

with C an arbitrary constant $r > R$ and

$$a_n = \frac{1}{\pi} \int_0^{2\pi} f(\theta) \cos n\theta \, d\theta, \quad n = 1, 2, \dots,$$

$$b_n = \frac{1}{\pi} \int_0^{2\pi} f(\theta) \sin n\theta \, d\theta, \quad n = 1, 2, \dots$$

8. The boundary value problem:

$$r^2 u_{rr}(r, \theta) + r u_r(r, \theta) + u_{\theta\theta}(r, \theta) = 0,$$

with $u(r, \theta)$, in polar coordinates in a semicircle of radius R , subject to the homogeneous Neumann conditions on the diameter of the semicircle

$$u(r, 0) = 0, \quad u(r, \pi) = 0, \quad 0 < r < R,$$

and the Dirichlet condition on the curved boundary of the semicircle

$$u(R, \theta) = f(\theta), \quad 0 < \theta < \pi.$$

Solution

$$u(r, \theta) = \frac{1}{2} a_0 + \sum_{n=1}^{\infty} c_n \left(\frac{r}{R} \right)^n \cos n\theta, \quad \text{with } a_n = \frac{2}{\pi} \int_0^{\pi} f(\theta) \cos n\theta \, d\theta.$$

9. The boundary value problem in a semiannulus $1 < r < R$, $0 < \theta < \pi$:

$$r^2 u_{rr}(r, \theta) + r u_r(r, \theta) + u_{\theta\theta}(r, \theta) = 0,$$

with $u(r, \theta)$, in the polar coordinates, and subject to the Dirichlet conditions

$$u(r, 0) = 0, \quad u(r, \pi) = 0 \quad \text{on } 1 < r < R,$$

and

$$u(1, \theta) = 0, \quad u(R, \theta) = U \quad \text{on } 0 < \theta < \pi.$$

Solution

$$u(r, \theta) = \sum_{n=1}^{\infty} c_n (r^n - 1/r^n) \sin n\theta, \quad \text{with } c_n = \frac{2U}{\pi} \left[\frac{1 - (-1)^n}{n(R^n - 1/R^n)} \right].$$

10. The boundary value problem in a sector of an annulus:

$$r^2 u_{rr}(r, \theta) + r u_r(r, \theta) + u_{\theta\theta}(r, \theta) = 0,$$

with $u(r, \theta)$ in polar coordinates, in the circular sector of the annulus $r = R_1$, $r = R_2$, between radii $\theta = 0$ and $\theta = \Theta$, subject to the Dirichlet conditions $u(R_1, \theta) = f_1(\theta)$ and $u(R_2, \theta) = f_2(\theta)$.

Solution

$$u(r, \theta) = \sum_{n=1}^{\infty} \left(a_n r^{\pi n/\Theta} + b_n / r^{\pi n/\Theta} \right) \sin(\pi n \theta / \Theta), \quad R_1 < r < R_2,$$

with

$$a_n = \frac{R_2^{\pi n/\Theta} g_n - R_1^{\pi n/\Theta} h_n}{R_2^{2\pi n/\Theta} - R_1^{2\pi n/\Theta}}, \quad b_n = \frac{R_2^{\pi n/\Theta} h_n - R_1^{\pi n/\Theta} g_n}{R_2^{2\pi n/\Theta} - R_1^{2\pi n/\Theta}} (R_1 R_2)^{\pi n/\Theta},$$

and

$$g_n = \frac{2}{a} \int_0^{\Theta} f_2(\theta) \sin(\pi n \theta / \Theta) d\theta, \quad h_n = \frac{2}{a} \int_0^{\Theta} f_1(\theta) \sin(\pi n \theta / \Theta) d\theta.$$

11. The boundary value problem inside the finite cylinder $r \leq R$, $0 \leq z \leq L$:

$$\frac{\partial}{\partial r} \left(r \frac{\partial u}{\partial r} \right) + \frac{1}{r} \frac{\partial}{\partial \theta} \left(\frac{\partial u}{\partial \theta} \right) + \frac{\partial}{\partial z} \left(r \frac{\partial u}{\partial z} \right) = 0,$$

with $u(r, \theta, z)$ in cylindrical polar coordinates, subject to the Dirichlet boundary conditions

$$u(R, \theta, z) = 0, \quad u(r, \theta, 0) = f(r, \theta), \quad u(r, \theta, L) = F(r, \theta).$$

Solution

$$\begin{aligned}
u(r, \theta, z) &= \sum_{n=0}^{\infty} \sum_{m=1}^{\infty} (A_{mn} \cos n\theta + B_{mn} \sin n\theta) \\
&\quad \times J_n\left(\mu_m^{(n)} r/R\right) \frac{\sinh\left[\mu_m^{(n)} (L-z)/R\right]}{\sinh\left(\mu_m^{(n)} L/R\right)} \\
&\quad + \sum_{n=0}^{\infty} \sum_{m=1}^{\infty} (P_{mn} \cos n\theta + Q_{mn} \sin n\theta) J_n\left(\mu_m^{(n)} r/R\right) \frac{\sinh\left[\mu_m^{(n)} z/R\right]}{\sinh\left(\mu_m^{(n)} L/R\right)},
\end{aligned}$$

where $\mu_m^{(n)}$ is the m th positive root of $J_n(\mu) = 0$,

$$A_{mn} = \frac{2}{R^2 \pi \alpha_n \left[J_n'(\mu_m^{(n)})\right]^2} \int_0^{2\pi} \int_0^R f(r, \theta) \cos n\theta J_n\left(\mu_m^{(n)} r/R\right) r dr d\theta$$

$$\text{with } \alpha_n = \begin{cases} 2, & n = 0 \\ 1, & n \neq 0 \end{cases},$$

$$B_{mn} = \frac{2}{R^2 \pi \alpha_n \left[J_n'(\mu_m^{(n)})\right]^2} \int_0^{2\pi} \int_0^R f(r, \theta) \sin n\theta J_n\left(\mu_m^{(n)} r/R\right) r dr d\theta,$$

where P_{mn} is defined similarly to A_{mn} with $f(r, \theta)$ replaced by $F(r, \theta)$, and Q_{mn} is defined similarly to B_{mn} with $f(r, \theta)$ replaced by $F(r, \theta)$.

12. The boundary value problem:

$$\frac{\partial}{\partial r} \left(r^2 \frac{\partial u}{\partial r} \right) + \frac{1}{\sin \theta} \frac{\partial}{\partial \theta} \left(\sin \theta \frac{\partial u}{\partial \theta} \right) + \frac{1}{\sin^2 \theta} \frac{\partial^2 u}{\partial \phi^2} = 0$$

with $u(r, \theta, \phi)$ in the spherical polar coordinates related to cartesian coordinates by $x = r \sin \theta \cos \phi$, $y = r \sin \theta \sin \phi$, $z = r \cos \theta$, $0 \leq \theta \leq \pi$, $0 \leq \phi \leq 2\pi$, inside a sphere of radius R and subject to the Dirichlet condition

$$u(R, \theta, \phi) = f(\theta, \phi).$$

Solution

$$u(r, \theta, \phi) = \sum_{n=0}^{\infty} (r/R)^n Z_n(\theta, \phi), \quad r < R,$$

where

$$Z_n(\theta, \phi) = \sum_{k=0}^n (A_{nk} \cos k\phi + B_{nk} \sin k\phi) P_n^k(\cos \theta),$$

with $P_n^k(x) = (1-x^2)^{k/2} d^k P_n(x)/dx^k$ the **associated Legendre function** and

$$A_{00} = \frac{1}{4\pi} \int_0^{2\pi} \int_0^\pi f(\theta, \phi) \sin \theta \, d\theta \, d\phi,$$

$$A_{nk} = \frac{(2n+1)(n-k)!}{2\pi(n+k)!} \int_0^{2\pi} \int_0^\pi f(\theta, \phi) P_n^k(\cos \theta) \\ \times \cos k\phi \sin \theta \, d\theta \, d\phi \quad (n > 0),$$

$$B_{nk} = \frac{(2n+1)(n-k)!}{2\pi(n+k)!} \int_0^{2\pi} \int_0^\pi f(\theta, \phi) P_n^k(\cos \theta) \sin k\phi \sin \theta \, d\theta \, d\phi.$$

13. The boundary value problem:

$$\frac{\partial}{\partial r} \left(r^2 \frac{\partial u}{\partial r} \right) + \frac{1}{\sin \theta} \frac{\partial}{\partial \theta} \left(\sin \theta \frac{\partial u}{\partial \theta} \right) + \frac{1}{\sin^2 \theta} \frac{\partial^2 u}{\partial \phi^2} = 0$$

with $u(r, \theta, \phi)$ in the spherical polar coordinates related to cartesian coordinates by $x = r \sin \theta \cos \phi$, $y = r \sin \theta \sin \phi$, $z = r \cos \theta$, $0 \leq \theta \leq \pi$, $0 \leq \phi \leq 2\pi$, *outside* a sphere of radius R and subject to the Dirichlet condition

$$u(a, \theta, \phi) = f(\theta, \phi).$$

Solution

$$u(r, \theta, \phi) = \sum_{n=0}^{\infty} \sum_{k=0}^{\infty} (R/r)^{n+1} (A_{nk} \cos k\phi + B_{nk} \sin k\phi) P_n^k(\cos \theta), \quad r > R,$$

with the A_{nk} , B_{nk} and $P_n^k(\cos \theta)$ defined as in 12.

14. The boundary value problem:

$$\frac{\partial}{\partial r} \left(r^2 \frac{\partial u}{\partial r} \right) + \frac{1}{\sin \theta} \frac{\partial}{\partial \theta} \left(\sin \theta \frac{\partial u}{\partial \theta} \right) + \frac{1}{\sin^2 \theta} \frac{\partial^2 u}{\partial \phi^2} = 0$$

with $u(r, \theta, \phi)$ in the spherical polar coordinates related to cartesian coordinates by $x = r \sin \theta \cos \phi$, $y = r \sin \theta \sin \phi$, $z = r \cos \theta$, $0 \leq \theta \leq \pi$, $0 \leq \phi \leq 2\pi$, *inside* a sphere of radius R subject to the Neumann condition

$$u_r(R, \theta, \phi) = f(\theta, \phi),$$

and the requirement that

$$\int_0^{2\pi} \int_0^\pi f(\theta, \phi) d\theta d\phi = 0,$$

necessary for the existence of a solution.

Solution

$$u(r, \theta, \phi) = \sum_{n=1}^{\infty} \sum_{k=0}^{\infty} \left(\frac{r^n}{nR^{n-1}} \right) (A_{nk} \cos k\phi + B_{nk} \sin k\phi) P_n^k(\cos \theta) + C,$$

where C is an arbitrary constant, and the A_{nk} , B_{nk} and $P_n^{(k)}(\cos \theta)$ are defined as in 12.

15. The boundary value problem:

$$\frac{\partial}{\partial r} \left(r^2 \frac{\partial u}{\partial r} \right) + \frac{1}{\sin \theta} \frac{\partial}{\partial \theta} \left(\sin \theta \frac{\partial u}{\partial \theta} \right) + \frac{1}{\sin^2 \theta} \frac{\partial^2 u}{\partial \phi^2} = 0$$

with $u(r, \theta, \phi)$ in the spherical polar coordinates related to cartesian coordinates by $x = r \sin \theta \cos \phi$, $y = r \sin \theta \sin \phi$, $z = r \cos \theta$, $[0 \leq \theta \leq \pi, 0 \leq \phi \leq 2\pi]$, *inside* a sphere of radius R subject to the Neumann condition

$$-u_r(R, \theta, \phi) = f(\theta, \phi),$$

where the negative sign occurs because the derivative is along the outward-drawn normal to the surface of the sphere, and the requirement that

$$\int_0^{2\pi} \int_0^\pi f(\theta, \phi) d\theta d\phi = 0,$$

necessary for the existence of a solution.

Solution

$$u(r, \theta, \phi) = \sum_{n=1}^{\infty} \left(\frac{R^{n+2}}{(n+1)r^{n+1}} \right) Z_n(\theta, \phi) + C, \quad r > R,$$

with $Z_n(\theta, \phi)$ defined as in 12 and C an arbitrary constant.

27.2 PARABOLIC EQUATIONS (THE HEAT OR DIFFUSION EQUATION)

1. The initial boundary value problem:

$$u_t(x, t) = \kappa^2 u_{xx}(x, t) \quad \text{in the strip } 0 < x < L,$$

subject to the initial condition

$$u(x, 0) = f(x),$$

and the homogeneous Dirichlet boundary conditions

$$u(0, t) = 0, \quad u(L, t) = 0.$$

Solution

$$u(x, t) = \sum_{n=1}^{\infty} c_n \exp\left[-(n\pi\kappa/L)^2 t\right] \sin(n\pi x/L),$$

$$c_n = \frac{2}{L} \int_0^L f(x) \sin(n\pi x/L) dx.$$

2. The initial boundary value problem:

$$u_t(x, t) = \kappa^2 u_{xx}(x, t) \quad \text{in the strip } 0 < x < L,$$

subject to the initial condition

$$u(x, 0) = f(x), \quad 0 < x < L,$$

and the homogeneous Neumann boundary conditions

$$u_x(0, t) = 0, \quad u_x(L, t) = 0 \quad \text{for } t > 0.$$

Solution

$$u(x, t) = \frac{1}{2} a_0 + \sum_{n=1}^{\infty} a_n \exp\left[-(n\pi\kappa/L)^2 t\right] \cos(n\pi x/L),$$

with

$$a_n = \frac{2}{L} \int_0^L f(x) \cos(n\pi x/L) dx, \quad n = 0, 1, \dots$$

3. The initial boundary value problem:

$$u_t(x, t) = \kappa^2 u_{xx}(x, t) \quad \text{in the strip } 0 < x < L,$$

subject to the initial condition

$$u(x, 0) = f(x), \quad 0 < x < L,$$

the homogeneous Dirichlet boundary condition

$$u(0, t) = 0 \quad \text{for } t > 0,$$

and the homogeneous Neumann boundary condition

$$u_x(L, t) = 0 \quad \text{for } t > 0.$$

Solution

$$u(x, t) = \sum_{n=1}^{\infty} a_{2n-1} \exp[-(2n-1)^2 \pi^2 \kappa^2 t/4] \sin[(2n-1)\pi x/(2L)],$$

with

$$a_{2n-1} = \frac{2}{L} \int_0^L f(x) \sin[(2n-1)\pi x/2] dx.$$

4. The initial boundary value problem:

$$u_t(x, t) = \kappa^2 u_{xx}(x, t) + f(x, t) \quad \text{in the strip } 0 < x < L,$$

subject to the homogeneous initial condition

$$u(x, 0) = 0, \quad \text{for } 0 < x < L,$$

and the homogeneous Dirichlet boundary conditions

$$u(0, t) = 0, \quad \text{and} \quad u(L, t) = 0 \quad \text{for } t > 0.$$

Solution

$$u(x, t) = \sum_{n=1}^{\infty} \left\{ \int_0^t \exp[-(n\pi\kappa/L)^2(t-\tau)] f_n(\tau) d\tau \right\} \sin(n\pi x/L),$$

with

$$f_n(t) = \frac{2}{L} \int_0^L f(x, t) \sin(n\pi x/L) dx.$$

5. The initial boundary value problem *inside* a sphere of radius R :

$$u_t(r, t) = \kappa^2 \left(u_{rr} + \frac{2}{r} u_r \right), \quad r < R, \quad t > 0,$$

for $u(r, t)$ in spherical polar coordinates with spherical symmetry subject to the homogeneous Dirichlet boundary conditions

$$u(0, t) = 0, \quad u(R, t) = 0, \quad t > 0,$$

and the initial condition

$$u(r, 0) = rf(r).$$

Solution

$$u(r, t) = \sum_{n=1}^{\infty} A_n \exp[-(n\pi\kappa/R)^2 t] \frac{\sin(n\pi r/R)}{r}, \quad r < R,$$

with

$$A_n = \frac{2}{r} \int_0^R rf(r) \sin(n\pi r/R) dr.$$

6. The initial boundary value problem for $u(r, t)$ *inside* a sphere of radius R :

$$u_t(r, t) = \kappa^2 \left(u_{rr} + \frac{2}{r} u_r \right), \quad r < R, \quad t > 0,$$

with $u(r, t)$ in spherical polar coordinates with spherical symmetry, subject to the mixed boundary condition on the surface of the sphere

$$(\lambda u_r = q)_{r=R}, \quad t > 0,$$

and the initial condition

$$u(r, 0) = U, \quad 0 \leq r < R.$$

Solution

$$u(r, t) = U + \frac{qR}{\lambda} \left\{ \frac{3\kappa^2 t}{R^2} - \frac{3R^2 - 5r^2}{10R^2} - \sum_{n=1}^{\infty} \frac{2R \exp(-\kappa^2 \mu_n^2 t/R^2) \sin(\mu_n r/R)}{\mu_n^2 \cos \mu_n} \frac{1}{r} \right\}, \quad r < R,$$

with the constants μ_n the positive roots of $\tan \mu = \mu$.

7. The initial boundary value problem *inside* a sphere of radius R :

$$u_t(r, t) = \kappa^2 \left(u_{rr} + \frac{2}{r} u_r \right), \quad r < R, \quad t > 0,$$

with $u(r, t)$ in spherical polar coordinates with spherical symmetry, subject to the Robin boundary condition on the surface of the sphere

$$(u_r + hu)_{r=R} = 0, \quad t > 0,$$

and the initial condition

$$u(r, 0) = f(r), \quad 0 \leq r < R.$$

Solution

$$u(r, t) = \sum_{n=1}^{\infty} A_n \exp(-\kappa^2 \mu_n^2 t) \frac{\sin \mu_n r}{r}, \quad r < R,$$

with the constants μ_n the positive roots of

$$\tan \mu R = \frac{\mu R}{1 - Rh},$$

and

$$A_n = \frac{2}{R} \frac{R^2 \mu_n^2 + (Rh - 1)^2}{R^2 \mu_n^2 + (Rh - 1)Rh} \int_0^R r f(r) \sin \lambda_n r \, dr.$$

8. The initial boundary value problem *inside* an infinite cylinder of radius R :

$$u_t = \kappa^2 \frac{1}{r} \frac{\partial}{\partial r} \left(r \frac{\partial u}{\partial r} \right),$$

for $u(r, t)$ in cylindrical polar coordinates with cylindrical symmetry, subject to the initial condition

$$u(r, 0) = 0, \quad 0 \leq r < R,$$

and the boundary condition

$$u(R, t) = U(\text{constant}), \quad t > 0.$$

Solution

$$u(r, t) = U \left[1 - 2 \sum_{n=1}^{\infty} \exp(-\mu_n^2 \kappa^2 t / R^2) \right] \frac{J_0(\mu_n r / R)}{\mu_n J_1(\mu_n)},$$

where the numbers μ_n are the positive roots of $J_0(\mu) = 0$.

9. The initial boundary value problem *inside* an infinite cylinder of radius R :

$$u_t = \kappa^2 [u_{rr} + (1/r) u_r], \quad 0 \leq r < R, \quad t > 0,$$

for $u(r, t)$ in cylindrical polar coordinates, subject to the boundary condition

$$(\lambda u_r = q)_{r=R}, \quad t > 0,$$

and the initial condition

$$u(r, 0) = U(\text{constant}).$$

Solution

$$u(r, t) = U + \frac{qR}{\lambda} \left[2 \frac{\kappa^2 t}{R^2} - \frac{1}{4} \left(1 - 2 \frac{r^2}{R^2} \right) - \sum_{n=1}^{\infty} \frac{2 \exp(-\kappa^2 \mu_n^2 t / R^2)}{\mu_n^2 J_0(\mu_n)} J_0(\mu_n r / R) \right],$$

where the constants μ_n are the positive roots of $J_0'(\mu) = 0$.

10. The initial boundary value problem *inside* an infinite cylinder of radius R :

$$u_t = \kappa^2 [u_{rr} + (1/r)u_r], \quad 0 \leq r < R, \quad t > 0,$$

for $u(r, t)$ in cylindrical polar coordinates, subject to the Robin condition

$$(u_r + hu)_{r=R} = 0, \quad t > 0,$$

and the initial condition

$$u(r, 0) = f(r).$$

Solution

$$u(r, t) = \sum_{n=1}^{\infty} A_n \exp(-\mu_n^2 \kappa^2 t / R^2) J_0(\mu_n r / R),$$

with

$$A_n = \frac{2\mu_n^2}{R^2 (\mu_n^2 + h^2 R^2) [J_0'(\mu_n)]^2} \int_0^R r f(r) J_0(\mu_n r / R) dr,$$

where the numbers μ_n are the positive roots of

$$\mu J_0'(\mu) + hR J_0(\mu) = 0.$$

27.3 HYPERBOLIC EQUATIONS (WAVE EQUATION)

1. The **D'Alembert solution**, which is not derived by the methods of Section 25.2.1, concerns **traveling waves** and is of fundamental importance, because it shows how initial conditions specified at $t = 0$ on the infinite initial line influence the solution of the wave equation

$$u_{tt} = c^2 u_{xx}, \quad -\infty < x < \infty, \quad t > 0,$$

subject to the initial conditions

$$u(x, 0) = f(x), \quad u_t(x, 0) = k(x).$$

The D'Alembert solution is

$$u(x, t) = \frac{1}{2} [f(x - ct) + f(x + ct)] + \frac{1}{2c} \int_{x-ct}^{x+ct} k(\xi) d\xi.$$

This shows that the solution at a point (x_0, t_0) in the upper half of the (x, t) -plane depends only on the values of $f(x)$ at the ends of the interval $x_0 - ct_0$ and $x_0 + ct_0$ on the initial line, and on the behavior of $g(x)$ throughout this interval.

2. The wave equation on the interval $0 < x < L$:

$$u_{tt} = c^2 u_{xx}, \quad t > 0,$$

subject to the homogeneous boundary conditions

$$u(0, t) = 0, \quad u(L, t) = 0,$$

and the initial conditions

$$u(x, 0) = f(x), \quad u_t(x, 0) = g(x), \quad 0 < x < L.$$

Solution

$$u(x, t) = \sum_{n=1}^{\infty} [a_n \cos(n\pi ct/L) + b_n \sin(n\pi ct/L)] \sin(n\pi x/L),$$

with

$$a_n = \frac{2}{L} \int_0^L f(x) \sin(n\pi x/L) dx, \quad b_n = \frac{2}{n\pi L} \int_0^L g(x) \sin(n\pi x/L) dx.$$

3. The nonhomogeneous wave equation on the interval $0 < x < L$:

$$u_{tt} = c^2 u_{xx} + f(x, t), \quad t > 0,$$

subject to the homogeneous boundary conditions

$$u(0, t) = 0, \quad u(L, t) = 0,$$

and the initial conditions

$$u(x, 0) = \varphi(x), \quad u_t(x, 0) = \psi(x), \quad 0 < x < L.$$

Solution

$$u(x, t) = \sum_{n=1}^{\infty} U_n(t) \sin(n\pi x/L) + \sum_{n=1}^{\infty} [a_n \cos(n\pi ct/L) + b_n \sin(n\pi ct/L)] \sin(n\pi x/L),$$

where

$$U_n(t) = \frac{2}{n\pi c} \int_0^t \sin[n\pi c(t - \tau)/L] d\tau \int_0^L f(x, \tau) \sin(n\pi x/L) dx,$$

and the function $f(x, t)$ is given by

$$f(x, t) = \sum_{n=1}^{\infty} f_n(t) \sin(n\pi x/L),$$

with

$$f_n(t) = \frac{2}{L} \int_0^L f(x, t) \sin(n\pi x/L) dx,$$

and

$$a_n = \frac{2}{L} \int_0^L \varphi(x) \sin(n\pi x/L) dx, \quad b_n = \frac{2}{n\pi c} \int_0^L \psi(x) \sin(n\pi x/L) dx.$$

4. The wave equation in the rectangle $0 < x < a, 0 < y < b$:

$$u_{tt} = c^2(u_{xx} + u_{yy}), \quad 0 < x < a, \quad 0 < y < b,$$

subject to the homogeneous boundary conditions

$$\begin{aligned} u(0, y, t) &= 0, & u(a, y, t) &= 0, \\ u(x, 0, t) &= 0, & u(x, b, t) &= 0, \quad t > 0, \end{aligned}$$

and the initial conditions

$$u(x, y, 0) = \varphi(x, y), \quad u_t(x, y, 0) = \psi(x, y).$$

Solution

$$u(x, y, t) = \sum_{m=1}^{\infty} \sum_{n=1}^{\infty} (A_{mn} \cos ck_{mn}t + B_{mn} \sin ck_{mn}t) \sin(m\pi x/a) \sin(n\pi y/b),$$

where

$$A_{mn} = \frac{4}{ab} \int_0^a \int_0^b \varphi(x, y) \sin(m\pi x/a) \sin(n\pi y/b) dx dy,$$

$$B_{mn} = \frac{4}{ck_{mn}ab} \int_0^a \int_0^b \psi(x, y) \sin(m\pi x/a) \sin(n\pi y/b) dx dy,$$

and the numbers k_{mn} are given by

$$k_{mn}^2 = \pi^2 \left(\frac{m^2}{a^2} + \frac{n^2}{b^2} \right).$$

5. The wave equation in a circle of radius R :

$$u_{tt} = c^2 [u_{rr} + (1/r) u_r], \quad 0 \leq r \leq R, \quad t > 0,$$

with $u(r, t)$ in polar coordinates, subject to the Dirichlet boundary condition

$$u(R, t) = 0,$$

and the initial conditions

$$u(r, 0) = \varphi(r), \quad u_t(r, 0) = \psi(r).$$

Solution

$$u(r, t) = \sum_{n=1}^{\infty} [a_n \cos(c\mu_n t/R) + b_n \sin(c\mu_n t/R)] J_0(\mu_n r/R),$$

where

$$a_n = \frac{2}{R^2 [J_1(\mu_n)]^2} \int_0^R r \varphi(r) J_n(\mu_n r/R) dr,$$

$$b_n = \frac{2}{c\mu_n R [J_1(\mu_n)]^2} \int_0^R r \psi(r) J_n(\mu_n r/R) dr,$$

and the numbers μ_n are the positive roots of $J_0(\mu) = 0$.

6. The nonhomogeneous wave equation in a circle of radius R :

$$u_{tt} = c^2 [u_{rr} + (1/r) u_r] + P, \quad 0 \leq r \leq R, \quad t > 0 \quad (P = \text{constant}),$$

with $u(r, t)$ in polar coordinates, subject to the boundary condition

$$u(R, t) = 0, \quad t > 0,$$

and the initial conditions

$$u(r, 0) = 0, \quad u_t(r, 0) = 0, \quad 0 \leq r \leq R.$$

Solution

$$u(r, t) = \frac{P}{c^2} \left[\frac{R^2 - r^2}{4} - 2R^2 \sum_{n=1}^{\infty} \frac{J_0(\mu_n r/R)}{\mu_n^2 J_1(\mu_n)} \cos(c\mu_n t/R) \right],$$

where the numbers μ_n are the positive roots of $J_0(\mu) = 0$.

7. The wave equation in a circle of radius R :

$$u_{tt} = c^2 [u_{rr} + (1/r)u_r], \quad 0 \leq r \leq R, \quad t > 0,$$

with $u(r, t)$ in polar coordinates, subject to

$$u(R, \theta, t) = f(t) \cos n\theta, \quad f(0) = 0, \quad f'(0) = 0, \quad \text{with } n \text{ an integer.}$$

Solution

$$u(r, \theta, t) = [U(r, t) + (r/R)^2 f(t)] \cos n\theta,$$

where

$$U(r, t) = \frac{R}{c} \sum_{m=1}^{\infty} \frac{J_n(\mu_m r/R)}{\mu_m} \int_0^t \Phi_m(\tau) \sin[c\mu_m (t - \tau)/R] d\tau,$$

with

$$\Phi_m(t) = \frac{2 \int_0^R r [3c^2 f(t) - r^2 f''(t)] J_m(\mu_m r/R) dr}{R^4 [J'_n(\mu_m)]^2},$$

and the numbers μ_m the positive roots of $J_n(\mu) = 0$.

8. The wave equation in the annulus $R_1 < r < R_2$:

$$u_{tt} = c^2 [u_{rr} + (1/r)u_r], \quad R_1 \leq r \leq R_2, \quad t > 0,$$

with $u(r, t)$ in polar coordinates, subject to the boundary conditions

$$u(R_1, t) = 0, \quad u(R_2, t) = 0, \quad t > 0,$$

and the initial conditions

$$u(r, 0) = \varphi(r), \quad u_t(r, 0) = \psi(r).$$

Solution

$$u(r, t) = K_n(r) \left[\cos\left(\frac{\mu_n ct}{R_2}\right) \int_{R_1}^{R_2} \rho \varphi(\rho) U_{\mu_n}(\rho) d\rho + \frac{R_2}{\mu_n c} \sin\left(\frac{\mu_n ct}{R_2}\right) \int_{R_1}^{R_2} \rho \psi(\rho) U_{\mu_n}(\rho) d\rho \right],$$

where

$$K_n(r) = \frac{2}{R_2^2} \sum_{n=1}^{\infty} \frac{\mu_n^2 U_{\mu_n}(r)}{(4/\pi^2) - R_1^2 [U'_{\mu_n}(R_1)]^2},$$

$$U_{\mu}(r) = Y_0(\mu)J_0(\mu r/R_2) - J_0(\mu)Y_0(\mu r/R_2),$$

and the numbers μ_n are the positive roots of $U_{\mu}(R_1) = 0$.

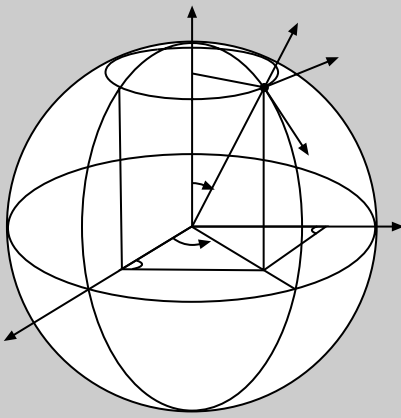

Chapter 28

The z-Transform

28.1 THE z-TRANSFORM AND TRANSFORM PAIRS

The **z-transform** converts a numerical sequence $x[n]$ into a function of the complex variable z , and it takes two different forms. The **bilateral** or **two-sided z-transform**, denoted here by $Z_b\{x[n]\}$, is used mainly in signal and image processing, while the **unilateral** or **one-sided z-transform**, denoted here by $Z_u\{x[n]\}$, is used mainly in the analysis of discrete time systems and the solution of linear difference equations.

The **bilateral z-transform** $X_b(z)$ of the sequence $x[n] = \{x_n\}_{n=-\infty}^{\infty}$ is defined as

$$Z_b\{x[n]\} = \sum_{n=-\infty}^{\infty} x_n z^{-n} = X_b(z),$$

and the **unilateral z-transform** $X_u(z)$ of the sequence $x[n] = \{x_n\}_{n=0}^{\infty}$ is defined as

$$Z_u\{x[n]\} = \sum_{n=0}^{\infty} x_n z^{-n} = X_u(z),$$

where each series has its own domain of convergence (DOC). The series $X_b(z)$ is a Laurent series, and $X_u(z)$ is the principal part of the Laurent series of $X_b(z)$. When $x_n = 0$ for $n < 0$,

the two z -transforms $X_b(z)$ and $X_u(z)$ are identical. In each case the sequence $x[n]$ and its associated z -transform is called a **z -transform pair**.

The inverse z -transformation $x[n] = Z^{-1}\{X(z)\}$ is given by

$$x[n] = \frac{1}{2\pi i} \int_{\Gamma} X(z) z^{n-1} dz,$$

where $X(z)$ is either $X_b(z)$ or $X_u(z)$, and Γ is a simple closed contour containing the origin and lying entirely within the domain of convergence of $X(z)$. In many practical situations the z -transform is either found by using a series expansion of $X(z)$ in the inversion integral or, if $X(z) = N(z)/D(z)$ where $N(z)$ and $D(z)$ are polynomials in z , by means of partial fractions and the use of an appropriate table of z -transform pairs. In order that the inverse z -transform is unique it is necessary to specify the domain of convergence, as can be seen by comparison of entries 3 and 4 of Table 28.2.

Table 28.1 lists general properties of the bilateral z -transform, and Table 28.2 lists some bilateral z -transform pairs. In what follows, use is made of the **unit integer function** $h(n) = \begin{cases} 0, & n < 0 \\ 1, & n \geq 0 \end{cases}$ that is a generalization of the Heaviside step function, and the **unit integer pulse function** $\Delta(n-k) = \begin{cases} 1, & n=k \\ 0, & n \neq k \end{cases}$ that is a generalization of the delta function.

The relationship between the Laplace transform of a continuous function $x(t)$ sampled at $t = 0, T, 2T, \dots$ and the unilateral z -transform of the function $\hat{x}(t) = \sum_{n=0}^{\infty} x(nT)\delta(t-nT)$ follows from the result

$$\begin{aligned} \mathcal{L}\{\hat{x}(t)\} &= \int_0^{\infty} \left[\sum_{k=0}^{\infty} x(kT)\delta(t-kT) \right] e^{-st} dt \\ &= \sum_{k=0}^{\infty} x(kT) e^{-ksT}. \end{aligned}$$

Setting $z = e^{sT}$ this becomes

$$\mathcal{L}\{\hat{x}(t)\} = \sum_{k=0}^{\infty} x(kT)z^{-k} = X(z),$$

showing that the unilateral z -transform $X_u(z)$ can be considered to be the Laplace transform of a continuous function $x(t)$ for $t \geq 0$ sampled at $t = 0, T, 2T, \dots$.

Table 28.3 lists some general properties of the unilateral z -transform, and Table 28.4 lists some unilateral z -transform pairs.

As an example of the use of the unilateral z -transform when solving a linear constant coefficient difference equation, consider the difference equation

$$x_{n+2} - 4x_{n+1} + 4x_n = 0 \quad \text{with the initial conditions } x_0 = 2, x_1 = 3.$$

Table 28.1. General Properties of the Bilateral z-Transform $X_b(n) = \sum_{n=-\infty}^{\infty} x_n z^{-n}$

Term in sequence	z-Transform $X_b(z)$	Domain of convergence
1. $\alpha x_n + \beta y_n$	$\alpha X_b(z) + \beta Y_b(z)$	Intersection of DOCs of $X_b(z)$ and $Y_b(z)$ with α, β constants
2. x_{n-N}	$z^{-N} X_b(z)$	DOC of $X_b(z)$ to which it may be necessary to add or delete the origin or the point at infinity
3. $n x_n$	$-z d X_b(z) / dz$	DOC of $X_b(z)$ to which it may be necessary to add or delete the origin and the point at infinity
4. $z_0^n x_n$	$X_b(z/z_0)$	DOC of $X_b(z)$ scaled by $ z_0 $
5. $n z_0^n x_n$	$-z d X_b(z/z_0) / dz$	DOC of $X_b(z)$ scaled by $ z_0 $ to which it may be necessary to add or delete the origin and the point at infinity
6. x_{-n}	$X_b(1/z)$	DOC of radius $1/R$, where R is the radius of convergence of DOC of $X_b(z)$
7. $n x_{-n}$	$-z d X_b(1/z) / dz$	DOC of radius $1/R$, where R is the radius of convergence of DOC of $X_b(z)$
8. \bar{x}_n	$\bar{X}_b(\bar{z})$	The same DOC as x_n
9. $\text{Re } x_n$	$\frac{1}{2} \{X_b(z) + \bar{X}_b(\bar{z})\}$	DOC contains the DOC of x_n
10. $\text{Im } x_n$	$\frac{1}{2i} \{X_b(z) - \bar{X}_b(\bar{z})\}$	DOC contains the DOC of x_n
11. $\sum_{k=-\infty}^{\infty} x_k y_{n-k}$	$X_b(z) Y_b(z)$	DOC contains the intersection of the DOCs of $X_b(z)$ and $Y_b(z)$ (convolution theorem)
12. $x_n y_n$	$\frac{1}{2\pi i} \int_{\Gamma} X_b(\zeta) Y_b(z/\zeta) \zeta^{-1} d\zeta$	DOC contains the DOCs of $X_b(z)$ and $Y_b(z)$, with Γ inside the DOC and containing the origin (convolution theorem)
13. Parseval formula	$\sum_{n=-\infty}^{\infty} x_n \bar{y}_n$ $= \frac{1}{2\pi i} \int_{\Gamma} X_b(\zeta) \bar{Y}_b(1/\bar{\zeta}) \zeta^{-1} d\zeta$	DOC contains the intersection of DOCs of $X_b(z)$ and $Y_b(z)$, with Γ inside the DOC and containing the origin
14. Initial value theorem for $x_n h(n)$	$x_0 = \lim_{z \rightarrow \infty} X_b(z)$	

Table 28.2. Basic Bilateral z-Transforms

Term in sequence	z-Transform $X_b(z)$	Domain of convergence
1. $\Delta(n)$	1	Converges for all z
2. $\Delta(n - N)$	z^{-N}	When $N > 0$ convergence is for all z except at the origin. When $N < 0$ convergence is for all z except at ∞
3. $a^n h(n)$	$\frac{z}{z - a}$	$ z > a $
4. $a^n h(-n - 1)$	$\frac{z}{z - a}$	$ z < a $
5. $na^n h(n)$	$\frac{az}{(z - a)^2}$	$ z > a > 0$
6. $na^n h(-n - 1)$	$\frac{az}{(z - a)^2}$	$ z < a, a > 0$
7. $n^2 a^n h(n)$	$\frac{za(z + a)}{(z - a)^3}$	$ z > a > 0$
8. $\{(1/a)^n + (1/b)^n\}h(n)$	$\frac{az}{az - 1} + \frac{bz}{bz - 1}$	$ z > \max\{1/ a , 1/ b \}$
9. $a^n h(n - N)$	$\frac{z(1 - (a/z)^N)}{z - a}$	$ z > 0$
10. $h(n) a^n \sin \Omega n$	$\frac{az \sin \Omega}{z^2 - 2az \cos \Omega + a^2}$	$ z > a > 0$
11. $h(n) a^n \cos \Omega n$	$\frac{z(z - a \cos \Omega)}{z^2 - 2az \cos \Omega + a^2}$	$ z > a > 0$
12. $e^{an} h(n)$	$\frac{z}{z - e^a}$	$ z > e^{-a}$
13. $h(n) e^{-an} \sin \Omega n$	$\frac{ze^a \sin \Omega}{z^2 e^{2a} - 2ze^a \cos \Omega + 1}$	$ z > e^{-a}$
14. $h(n) e^{-an} \cos \Omega n$	$\frac{ze^a (ze^a - \cos \Omega)}{z^2 e^{2a} - 2ze^a \cos \Omega + 1}$	$ z > e^{-a}$

Direct calculation shows that the first few terms of this difference equation are $x_0 = 2$, $x_1 = 3$, $x_2 = 4$, $x_3 = 4$, $x_4 = 0$, $x_5 = -16, \dots$. Taking the unilateral z-transform of this difference equation and using the linearity of the transform (entry 1 in Table 28.3) with entry 2 in the same table gives

$$\underbrace{(z^2 X_u - z^2 x_0 - z x_1)}_{Z_u \{ \{x_{n+2}\}_{n=0}^\infty \}} - \underbrace{4(z X_u - z x_0)}_{Z_u \{ \{x_{n+1}\}_{n=0}^\infty \}} + \underbrace{X_u}_{Z_u \{ \{x_n\}_{n=0}^\infty \}} = 0,$$

Table 28.3. General Properties of the Unilateral z-Transform $X_u(n) = \sum_{n=0}^{\infty} x_n z^{-n}$

Term in sequence	z-Transform $X_u(z)$	Domain of convergence
1. $\alpha x_n + \beta y_n$	$\alpha X_u(z) + \beta Y_u(z)$	Intersection of DOCs of $X_u(z)$ and $Y_u(z)$ with α, β constants
2. x_{n+k}	$z^k X_u(z) - z^k x_0 - z^{k-1} x_1 - z^{k-2} x_2 - \cdots - z x_{k-1}$	
3. $n x_n$	$-z dX_u(z)/dz$	DOC of $X_u(z)$ to which it may be necessary to add or delete the origin and the point at infinity
4. $z_0^n x_n$	$X_u(z/z_0)$	DOC of $X_u(z)$ scaled by $ z_0 $ to which it might be necessary to add or delete the origin and the point at infinity
5. $n z_0^n x_n$	$-z dX_u(z/z_0)/dz$	DOC of $X_u(z)$ scaled by $ z_0 $ to which it may be necessary to add or delete the origin and the point at infinity
6. \bar{x}_n	$\bar{X}_u(\bar{z})$	The same DOC as x_n
7. $\operatorname{Re} x_n$	$\frac{1}{2} \{X_u(z) + \bar{X}_u(\bar{z})\}$	DOC contains the DOC of x_n
8. $\frac{\partial}{\partial \alpha} x_n(\alpha)$	$\frac{\partial}{\partial \alpha} X_u(z, \alpha)$	Same DOC as $x_n(\alpha)$
9. Initial value theorem	$x_0 = \lim_{z \rightarrow \infty} X_u(z)$	
10. Final value theorem	$\lim_{n \rightarrow \infty} x_n = \lim_{z \rightarrow 1} \left[\left(\frac{z-1}{z} \right) X_u(z) \right]$ when $X_u(z) = N(z)/D(z)$ with $N(z), D(z)$ polynomials in z and the zeros of $D(z)$ inside the unit circle $ z = 1$ or at $z = 1$	

and so

$$X_u(z) = \frac{2z^2 - 5z}{(z-2)^2}.$$

To determine the inverse z-transform by means of entries in Table 28.4, $X_u(z)$ must first be written in the form

$$\frac{X_u(z)}{z} = \frac{2z - 5}{(z-2)^2}.$$

Table 28.4. Basic Unilateral z-Transforms

Term in sequence	z-Transform $X_u(z)$	Domain of convergence
1. $\Delta(n)$	1	Converges for all z
2. $\Delta(n - k)$	z^{-k}	Convergence for all $z \neq 0$
3. $a^n h(n)$	$\frac{z}{z - a}$	$ z > a $
4. $na^n h(n)$	$\frac{az}{(z - az)^2}$	$ z > a > 0$
5. $n^2 a^n h(n)$	$-\frac{za(z + a)}{(a - z)^3}$	$ z > a > 0$
6. $na^{n-1} h(n)$	$\frac{z}{(z - a)^2}$	$ z > a > 0$
7. $(n - 1)a^n h(n)$	$\frac{z(2a - z)}{(z - a)^2}$	$ z > a > 0$
8. $e^{-an} h(n)$	$\frac{ze^a}{ze^a - 1}$	$ z > e^{-a}$
9. $ne^{-an} h(n)$	$\frac{ze^{-a}}{(z - e^{-a})^2}$	$ z > e^{-a}$
10. $n^2 e^{-an} h(n)$	$\frac{ze^{-a}(z + e^{-a})}{(z - e^{-a})^3}$	$ z > e^{-a}$
11. $h(n)e^{-an} \sin \Omega n$	$\frac{ze^a \sin \Omega}{z^2 e^{2a} - 2ze^a \cos \Omega + 1}$	$ z > e^{-a}$
12. $h(n)e^{-an} \cos \Omega n$	$\frac{ze^a (ze^a - \cos \Omega)}{z^2 e^{2a} - 2ze^a \cos \Omega + 1}$	$ z > e^{-a}$
13. $h(n) \sinh an$	$\frac{z \sinh a}{z^2 - 2z \cosh a + 1}$	$ z > e^{-a}$
14. $h(n) \cosh an$	$\frac{z(z - \cosh a)}{z^2 - 2z \cosh a + 1}$	$ z > e^{-a}$
15. $h(n)a^{n-1}e^{-an} \sin \Omega n$	$\frac{ze^a \sin \Omega}{z^2 e^{2a} - 2zae^a \cos \Omega + a^2}$	$ z > e^{-a}$
16. $h(n)a^n e^{-an} \cos \Omega n$	$\frac{ze^a (ze^a - a \cos \Omega)}{z^2 - 2zae^a \cos \Omega + a^2}$	$ z > e^{-a}$

A partial fraction representation gives

$$X_u(z) = \frac{2z}{z - 2} - \frac{z}{(z - 2)^2},$$

Using entries 3 and 4 of Table 28.4 to find the inverse unilateral z-transform shows that

$$x_n = 2 \cdot 2^n - n2^{n-1}, \quad \text{or} \quad x_n = 2^{n-1}(4 - n) \quad \text{for } n = 0, 1, 2, \dots$$

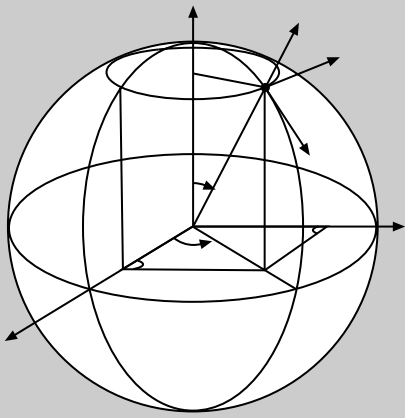

Chapter 29

Numerical Approximation

29.1 INTRODUCTION

The derivation of numerical results usually involves approximation. Some of the most common reasons for approximation are round-off error, the use of interpolation, the approximate values of elementary functions generated by computer sub-routines, the numerical approximation of definite integrals, and the numerical solution of both ordinary and partial differential equations.

This section outlines some of the most frequently used methods of approximation, ranging from linear interpolation, spline function fitting, the economization of series and the Padé approximation of functions, to finite difference approximations for ordinary and partial derivatives. More detailed information about these methods, their use, and suitability in varying circumstances can be found in the numerical analysis references at the end of the book.

29.1.1 Linear Interpolation

Linear interpolation is the simplest way to determine the value of a function $f(x)$ at a point $x = c$ in the interval $x_0 \leq x \leq x_1$ when it is known only at the data points $x = x_0$ and $x = x_1$ at the ends of the interval, where it has the respective values $f(x_0)$ and $f(x_1)$. This involves fitting a straight line L through the data points $(x_0, f(x_0))$ and $(x_1, f(x_1))$, and approximating $f(c)$ by the point on line L where $x = c$, with $x_0 < c < x_1$. The formula for linear interpolation is

$$f(x) = f(x_0) + \left[\frac{f(x_1) - f(x_0)}{x_1 - x_0} \right] (x - x_0), \quad x_0 \leq x \leq x_1.$$

29.1.2 Lagrange Polynomial Interpolation

If a function $f(x)$ is known only at the data points x_0, x_1, \dots, x_n where its values are, respectively, $f(x_0), f(x_1), \dots, f(x_n)$, the Lagrange interpolation polynomial $F(x)$ of degree n for $f(x)$ in the interval $x_0 \leq x \leq x_n$ is

$$F(x) = \sum_{r=0}^n f(x_r) L_r(x)$$

where

$$L_r(x) = \frac{(x - x_0)(x - x_1) \cdots (x - x_{r-1})(x - x_{r+1}) \cdots (x - x_n)}{(x_r - x_0)(x_r - x_1) \cdots (x_r - x_{r-1})(x_r - x_{r+1}) \cdots (x_r - x_n)}.$$

Inspection of this interpolation polynomial shows that it passes through each of the known data points $(x_0, f(x_0)), (x_1, f(x_1)), \dots, (x_n, f(x_n))$. However it is not advisable to use Lagrange interpolation over many more than three points, because interpolation by polynomials of degree greater than three is likely to cause $F(x)$ to be subject to large oscillations between the data interpolation points.

When interpolation is necessary and more than three data points are involved, a possible approach is to use Lagrange interpolation polynomials between successive groups of three data points. This has the disadvantage that where successive interpolation polynomials meet at a data interpolation point $x = x_r$, say, neither takes account of the variation of the other in the vicinity of x_r . Consequently, when the set of interpolation polynomials is graphed, although the resulting curve is continuous, it has discontinuities in its derivative wherever consecutive pairs of interpolation polynomials meet. This difficulty can be overcome by using spline interpolation that is outlined next.

29.1.3 Spline Interpolation

Cubic spline interpolation is the most frequently used form of spline interpolation, and it is particularly useful when a smooth curve needs to be generated between known fixed points. The idea is simple, and it involves fitting a cubic equation between each pair of interpolation data points and requiring that where consecutive polynomials meet their functional values coincide, and both the slope of each polynomial and its second derivative are continuous.

When graphed, a cubic spline interpolation approximation is a smooth curve that passes through each data point. The data points where the cubics meet are called the *knots* of the spline interpolation. The generation of cubic spline interpolation polynomials, and their subsequent graphing is computationally intensive, so it is only performed by computer.

Many readily available numerical packages provide the facility for spline function interpolation that allows for different conditions at the ends of the interval over which interpolation is required. A *natural* or *linear spline* end condition allows the interpolation function to become linear at an end, a *parabolic spline* end condition causes the cubic spline to reduce to a parabolic approximation at the end of the interval and *periodic spline* end conditions are suitable for functions that are believed to be periodic over the interval of approximation.

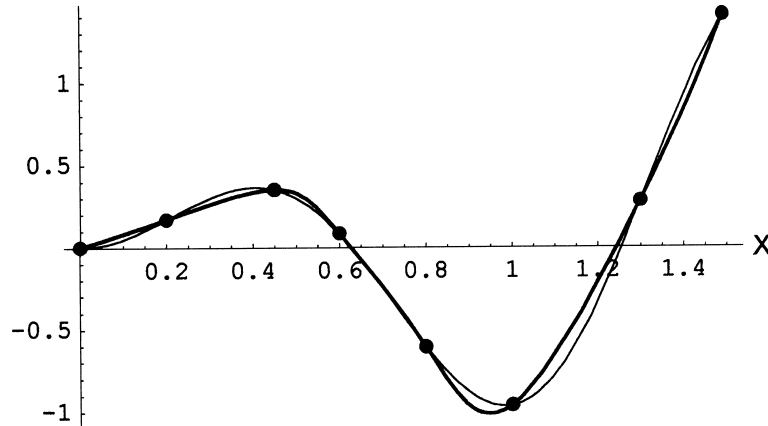

Figure 29.1. A cubic spline interpolation of $f(x) = x \sin 5x$ using eight data points.

A cubic spline interpolation of the function $f(x) = x \sin 5x$ over the interval $0 \leq x \leq 1.5$, using eight data points and with natural end conditions is illustrated in Figure 29.1, where the data points are shown as dots, the spline function interpolation is shown as the thin line and the original function $f(x) = x \sin 5x$ as the thick line.

29.2 ECONOMIZATION OF SERIES

When a power series approximation is used repeatedly, as in a subroutine, it is often desirable to minimize the number of multiplications that are involved by using a process called the *economization of series*. This is based on the use of Chebyshev polynomials, where the objective is that given a series $f(x) = \sum_{r=0}^n a_r x^r$ in an interval $-1 \leq x \leq 1$, and a number $R > 0$ representing the absolute error that is to be allowed, it is required to find an approximation $F(x) = \sum_{r=0}^N b_r x^r$ where N is as small as possible, such that $|F(x) - f(x)| < R$.

The approach uses the special property of Chebyshev polynomials that enables them to provide approximations in which the *maximum deviation* from the function to be approximated is made as *small* as possible. It involves first replacing each power of x in the series $f(x)$ by its representation in terms of the Chebyshev polynomials $T_r(x)$, and then collecting terms so that $f(x)$ is expressed as the sum $f(x) = \sum_{r=0}^n b_r T_r(x)$. As Chebyshev polynomials have the property that $|T_n(x)| \leq 1$ for $-1 \leq x \leq 1$ (see Section 18.3), the objective is attained within the required accuracy by using the truncated approximation $F(x) = \sum_{r=0}^N b_r T_r(x)$ where N is such that $\sum_{r=N+1}^n |b_r| < R$. The required economized polynomial approximation in terms of x is obtained by expressing the truncated series $F(x)$ in terms of powers of x .

To illustrate this approach we find an economized polynomial approximation for

$$f(x) = 1 + \frac{1}{3}x + \frac{1}{5}x^2 + \frac{1}{7}x^3 + \frac{1}{9}x^5 \quad \text{for } -1 \leq x \leq 1, \quad \text{with } R = 0.01.$$

Replacing powers of x by their representation in terms of Chebyshev polynomials gives

$$f(x) = \left(1 + \frac{1}{10}\right) T_0 + \left(\frac{1}{3} + \frac{3}{28} + \frac{5}{72}\right) T_1 + \frac{1}{10} T_2 + \left(\frac{1}{28} + \frac{5}{144}\right) T_3 + \frac{1}{144} T_5,$$

or

$$f(x) = \frac{11}{10} T_0 + \frac{771}{1512} T_1 + \frac{1}{10} T_2 + \frac{71}{1008} T_3 + \frac{1}{144} T_5.$$

An approximation with $R = 0.01$ is given by

$$F(x) = \frac{11}{10} T_0 + \frac{771}{1512} T_1 + \frac{1}{10} T_2 + \frac{71}{1008} T_3,$$

because

$$|b_5| = \left| \frac{1}{144} \right| = 0.00694 < 0.01.$$

When expressed in terms of powers of x this gives the approximation

$$F(x) = 1 + 0.298612x + 0.2x^2 + 0.281744x^3 \quad \text{for } -1 \leq x \leq 1.$$

The error $f(x) - F(x)$ is shown in Figure 29.2, from which it can be seen that the Chebyshev polynomials used in the approximation distribute the error over the interval $-1 \leq x \leq 1$. This

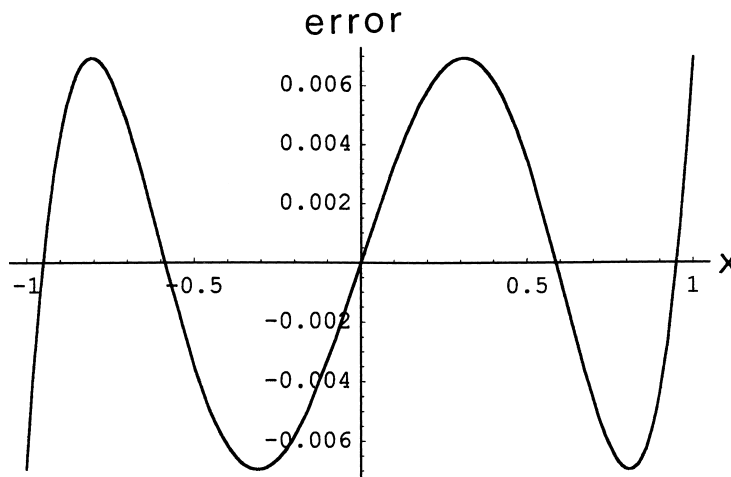

Figure 29.2. The error $f(x) - F(x)$ as a function of x for $-1 \leq x \leq 1$.

contrasts with a Taylor polynomial approximation of the same degree (in this case the first four terms of $f(x)$), that has the least absolute error close to the origin and the greatest absolute error at the ends of the interval $-1 \leq x \leq 1$, where in this case it is $1/9$.

If a representation is required over the interval $a \leq x \leq b$, a change of variable must first be made to scale the interval to $-1 \leq x \leq 1$.

29.3 PADÉ APPROXIMATION

An effective and concise form of approximation is provided by *Padé approximation* in which a function $f(x)$ defined over an interval $a \leq x \leq b$ is approximated by a function of the form $F(x) = N(x)/D(x)$, where $N(x)$ and $D(x)$ are polynomials with no common zeros. This type of approximation can be used with functions $f(x)$ that are analytic over the interval $a \leq x \leq b$, and also with functions that have singularities in the interval at which the function becomes infinite. In the latter case the zeros of $D(x)$ are chosen to coincide with the singularities of $f(x)$ inside the interval.

Unless there is a reason to do otherwise, the degrees of the polynomial $N(x)$ in the numerator and $D(x)$ in the denominator of a Padé approximation are usually chosen to be the same. If, however, the function $f(x)$ to be approximated is an even function, $N(x)$ and $D(x)$ are both chosen to be even functions, while if $f(x)$ is odd, one of the functions $N(x)$ and $D(x)$ is chosen to be even and the other to be odd. As already stated, when the function to be approximated has singularities in the interval, the zeros of $D(x)$ are taken to coincide with the singularities.

The determination of a Padé approximation $F(x)$ for $f(x)$ over the interval $a \leq x \leq b$ is determined as follows where, by way of example, $f(x)$ is supposed to be neither even nor odd so the degrees of $N(x)$ and $D(x)$ are both taken to be n .

Setting

$$F(x) = \frac{a_1(x-a)^n + a_2(x-a)^{n-1} + \cdots + a_n(x-a) + f(a)}{b_1(x-a)^n + b_2(x-a)^{n-1} \cdots + b_n(x-a) + 1},$$

the values of $f(x)$ are computed at $2n$ points x_1, x_2, \dots, x_{2n} distributed over the interval $a \leq x \leq b$ in such a way that the functional values at these points provide a good representation of $f(x)$ away from any singularities that might occur. Set $f_r = f(x_r)$ with $r = 1, 2, \dots, 2n$, where the initial point $x = a$ is excluded from this set of $2n$ points. Then, for each value x_r set $F(x_r) = f_r$, so that after multiplication of $F(x)$ by $b_1(x_r - a)^n + \cdots + b_n(x_r - a) + 1$,

$$a_1(x_r - a)^n + \cdots + a_n(x_r - a) + f(a) = f_r[b_1(x_r - a)^n + \cdots + b_n(x_r - a) + 1],$$

with $r = 1, 2, \dots, 2n$. These $2n$ equations determine the $2n$ coefficients $a_1, a_2, \dots, a_n, b_1, b_2, \dots, b_n$ to be used in the Padé approximation.

The approach is different if $f(x)$ is analytic in an interval of interest that contains no singularities of $f(x)$ and the function is known in the form of a power series. The method used in such a case is illustrated by finding a Padé approximation for $\sin x$ based on the first four terms of its Maclaurin series

$$\sin x = x - \frac{1}{6}x^3 + \frac{1}{120}x^5 - \frac{1}{5040}x^7.$$

The sine function is an odd function, so a Padé approximation is sought of the form

$$x - \frac{1}{6}x^3 + \frac{1}{120}x^5 - \frac{1}{5040}x^7 = \frac{x + a_1x^3}{1 + b_1x^2 + b_2x^4},$$

where the numerator is an odd polynomial function of degree three and the denominator is an even polynomial function of degree four.

Multiplying this representation by $1 + b_1x^2 + b_2x^4$ and equating corresponding powers of x on each side of the equation gives:

$$b_1 - \frac{1}{6} = a_1, \quad b_2 - \frac{1}{6}b_1 + \frac{1}{120} = 0, \quad -\frac{1}{5040} + \frac{1}{120}b_1 - \frac{1}{6}b_2 = 0,$$

so $a_1 = -31/294$, $b_1 = 3/49$ and $b_2 = 11/5880$. Substituting for a_1 , b_1 and b_2 in the original expression and clearing fractions shows that the required Padé approximation to be

$$\sin x \approx F(x) = \frac{5880x - 620x^3}{5880 + 360x^2 + 11x^4}.$$

The positive zero of the numerator at 3.07959 provides a surprisingly good approximation to the zero of $\sin x$ at $\pi = 3.14159\dots$, despite the very few terms used in the Maclaurin series for $\sin x$. The Padé approximations $F(1) = 0.84147$, $F(2) = 0.90715$ and $F(3) = 0.08990$, should be compared with the true values $\sin 1 = 0.84147\dots$, $\sin 2 = 0.90929\dots$ and $\sin 3 = 0.14112\dots$.

An example of a Padé approximation to an analytic function that is neither even nor odd is provided by an approximation to $\exp(-x)$, based on the first nine terms of its Maclaurin series expansion and a rational approximation in which the numerator and denominator are both of degree four, yields

$$\exp(-x) \approx F(x) = \frac{1680 - 840x + 180x^2 - 20x^3 + x^4}{1680 + 840x + 180x^2 + 20x^3 + x^4}.$$

This approximation gives $F(-1) = 2.718281$, that should be compared with the true value $\exp(1) = e = 2.718281\dots$, similarly $F(-2) = 7.388889$ should be compared with the true

value $\exp(2) = 7.389056\dots$, and $F(-3) = 20.065421$ should be compared with the true value $\exp(3) = 20.085536\dots$.

A final example is provided by the Padé approximation to the odd function $\tan x$, based on the first five terms of its Maclaurin series expansion and a rational function approximation in which the numerator is an odd function of degree five and the denominator is an even function of degree four.

In this case the Padé approximation becomes

$$\tan x \approx F(x) = \frac{945x - 105x^3 + x^5}{945 - 420x^2 + 15x^4}.$$

The smallest positive zero of the denominator $945 - 420x^2 + 15x^4$ gives for the approximation to $\pi/2 = 1.57079\dots$ the surprisingly accurate estimate $\pi/2 \approx 1.57081$. The value $F(1.1) = 2.57215$ should be compared with the true value $\tan 1.1 = 2.57215\dots$, the value $F(1.5) = 14.10000$ should be compared with the true value $\tan 1.5 = 14.10141\dots$ and the value $F(1.57) = 1237.89816$ should be compared with the true value $\tan 1.57 = 1255.76559\dots$.

29.4 FINITE DIFFERENCE APPROXIMATIONS TO ORDINARY AND PARTIAL DERIVATIVES

Taylor's theorem can be used to approximate ordinary derivatives of a suitably differentiable function $u(x)$ at a point $x = x_0$ in terms of values of $u(x)$ at one or more points to the left and right of x_0 that are separated from each other by an increment $\pm h$. For example, an approximation to $f'(x_0)$ can be obtained from Taylor's theorem with a remainder as follows:

$$u(x_0 + h) = u(x_0) + hu'(x_0) + \frac{1}{2}h^2u''(x_0 + \xi h), \quad 0 < \xi < 1,$$

$$u(x_0 - h) = u(x_0) - hu'(x_0) + \frac{1}{2}h^2u''(x_0 + \eta h), \quad 0 < \eta < 1.$$

Differencing these expressions and rearranging terms gives

$$u'(x_0) = \frac{1}{2h}(u_1 - u_{-1}) + O(h^2),$$

where $u_{-1} = u(x_0 - h)$ and $u_1 = u(x_0 + h)$. So, to order h^2 ,

$$u'(x_0) = \frac{1}{2h}(u_1 - u_{-1}).$$

Similar arguments lead to the following finite difference approximations to an accuracy $O(h^2)$ to higher order derivatives of a suitably differentiable function $u(x)$, where the notation $u_{\pm n} = u(x_0 \pm nh)$, $n = 0, 1, 2$.

<i>Ordinary derivative</i>	<i>Finite difference approximation</i>	<i>Order of error</i>
$u'(x_0)$	$\frac{1}{2h}(u_1 - u_{-1})$	$O(h^2)$
$u''(x_0)$	$\frac{1}{h^2}(u_1 - 2u_0 + u_{-1})$	$O(h^2)$
$u'''(x_0)$	$\frac{1}{2h^3}(u_2 - 2u_1 + 2u_{-1} - u_{-2})$	$O(h^2)$
$u^{(4)}(x_0)$	$\frac{1}{h^4}(u_2 - 4u_1 + 6u_0 - 4u_{-1} + u_{-2})$	$O(h^2)$

The same method can be used to derive finite difference approximations to an accuracy $O(h^2)$ to the partial derivatives of a suitably differentiable function $u(x, y)$ about a point (x_0, y_0) in terms of values of $u(x, y)$ at points separated from each other by increments $\pm h$. Using the notation $U_{\pm m, \pm n} = u(x_0 \pm mh, y_0 \pm nh)$, the following are commonly used finite difference approximations to partial derivatives.

<i>Partial derivative</i>	<i>Finite difference approximation</i>	<i>Order of error</i>
$u_x(x_0, y_0)$	$\frac{1}{2h}(u_{1,0} - u_{-1,0})$	$O(h^2)$
$u_y(x_0, y_0)$	$\frac{1}{2h}(u_{0,1} - u_{0,-1})$	$O(h^2)$
$u_{xy}(x_0, y_0)$	$\frac{1}{4h^2}(u_{1,1} - u_{1,-1} - u_{-1,1} + u_{-1,-1})$	$O(h^2)$
$u_{xx}(x_0, y_0)$	$\frac{1}{h^2}(u_{1,0} - 2u_{0,0} + u_{-1,0})$	$O(h^2)$
$u_{yy}(x_0, y_0)$	$\frac{1}{h^2}(u_{0,1} - 2u_{0,0} + u_{0,-1})$	$O(h^2)$
$u_{xxxx}(x_0, y_0)$	$\frac{1}{h^4}(u_{2,0} - 4u_{1,0} + 6u_{0,0} - 4u_{-1,0} + u_{-2,0})$	$O(h^2)$
The Laplacian at (x_0, y_0)		
$u_{xx}(x_0, y_0)$	$\frac{1}{h^2}(u_{1,0} + u_{-1,0} + u_{0,1} + u_{0,-1} - 4u_{0,0})$	$O(h^2)$

The pattern of points around (x_0, y_0) leading to a finite difference approximation to a partial derivative is called a *computational molecule* and the patterns for the above partial derivatives are as follows:

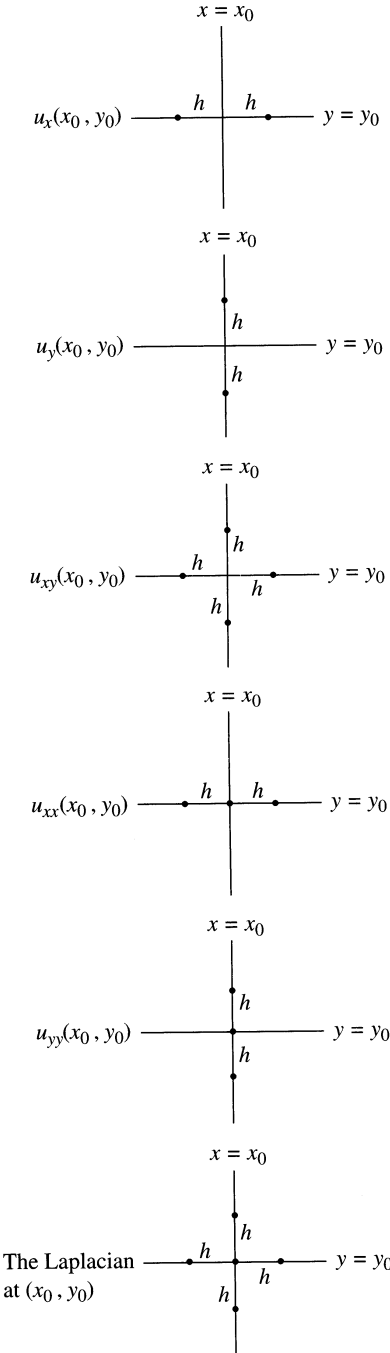

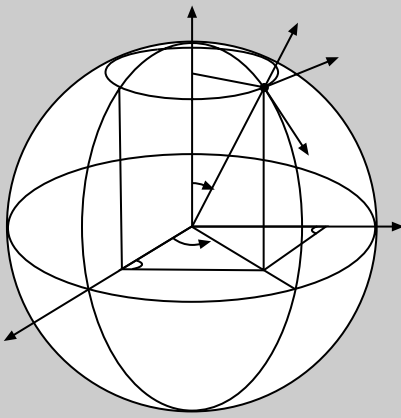

Chapter 30

Conformal Mapping and Boundary Value Problems

30.1 ANALYTIC FUNCTIONS AND THE CAUCHY-RIEMANN EQUATIONS

A complex function $w = f(z) = u + iv$, where either $z = x + iy$ or $z = re^{i\theta}$, is said to be **analytic** in a domain D of the complex plane if, and only if, it is differentiable at every point of D . Other terms used in place of *analytic* but with the same meaning are **regular** and **holomorphic**. A function $f(z)$ that is analytic throughout the entire complex z -plane is called an **entire function** an example of which is $f(z) = \exp(z)$. For a function $f(z)$ to be analytic in a domain D in the complex z -plane, it is necessary that it satisfies the Cauchy-Riemann equations at every points of D . In Cartesian form the Cauchy-Riemann equations are

$$1. \quad \frac{\partial u}{\partial x} = \frac{\partial v}{\partial y} \quad \text{and} \quad \frac{\partial u}{\partial y} = -\frac{\partial v}{\partial x},$$

while in modulus/argument form—that is, when expressed in terms of r and θ —the Cauchy-Riemann equations become

$$2. \quad \frac{\partial u}{\partial r} = \frac{1}{r} \frac{\partial v}{\partial \theta} \quad \text{and} \quad \frac{\partial v}{\partial r} = -\frac{1}{r} \frac{\partial u}{\partial \theta}, \quad r \neq 0.$$

If $w = f(z)$ is analytic, when expressed in Cartesian form its derivative $dw/dz = f'(z)$ is given by

$$3. \quad f'(z) = \frac{\partial u}{\partial x} + i \frac{\partial v}{\partial x} = \frac{\partial v}{\partial y} - i \frac{\partial u}{\partial y}.$$

30.2 HARMONIC CONJUGATES AND THE LAPLACE EQUATION

If $f(z) = u + iv$ is analytic in a domain D , the real functions u and v that satisfy the Cauchy-Riemann equations are said to be **harmonic conjugates**. However, if $f(z) = u_1 + iv_1$ and $g(z) = u_2 + iv_2$ are analytic, then although u_1 and v_1 are harmonic conjugates, as are u_2 and v_2 , when paired differently the functions u_1 and v_2 , and the functions u_2 and v_1 are *not* harmonic conjugates.

The differentiability of $f(z)$ implies the equality of the mixed derivatives u_{xy} and u_{yx} and also of v_{xy} and v_{yx} . So, working with the Cartesian form of the equations, differentiation of the first Cauchy-Riemann equation first with respect to x and the second with respect to y shows that u satisfies the two-dimensional Laplace equation

$$4. \quad \frac{\partial^2 u}{\partial x^2} + \frac{\partial^2 u}{\partial y^2} = 0,$$

while differentiation in the reverse order shows that v is also a solution of the two-dimensional Laplace equation

$$5. \quad \frac{\partial^2 v}{\partial x^2} + \frac{\partial^2 v}{\partial y^2} = 0.$$

Similar reasoning shows that when the Cauchy-Riemann equations are expressed in modulus/argument form, the Laplace equations satisfied by u and v become

$$6. \quad \frac{\partial^2 u}{\partial r^2} + \frac{1}{r} \frac{\partial u}{\partial r} + \frac{1}{r^2} \frac{\partial^2 u}{\partial \theta^2} = 0 \quad \text{and} \quad \frac{\partial^2 v}{\partial r^2} + \frac{1}{r} \frac{\partial v}{\partial r} + \frac{1}{r^2} \frac{\partial^2 v}{\partial \theta^2} = 0.$$

A real valued function $\Phi(x, y)$ that satisfies the Laplace equation

$$7. \quad \frac{\partial^2 \Phi}{\partial x^2} + \frac{\partial^2 \Phi}{\partial y^2} = 0$$

is said to be a **harmonic function**, so u and v , the respective real and imaginary parts of an analytic function $f(z)$, are *harmonic functions*.

30.3 CONFORMAL TRANSFORMATIONS AND ORTHOGONAL TRAJECTORIES

It is a direct consequence of the Cauchy-Riemann equations that if $f(z) = u + iv$ is an analytic function, the curves $u = \text{const.}$ and $v = \text{const.}$ when drawn in the (x, y) -plane form mutually **orthogonal trajectories** (they intersect at right angles). However, at certain isolated points called *critical points*, this property ceases to be true (see **30.5**).

Let two curves γ_1 and γ_2 drawn in the complex z -plane intersect at a point P , as shown in Figure 30.1(a), where their angle of intersection is α , and suppose the sense of rotation from γ_1 to γ_2 is counterclockwise. Then, when an analytic function $w = f(z)$ maps these curves in

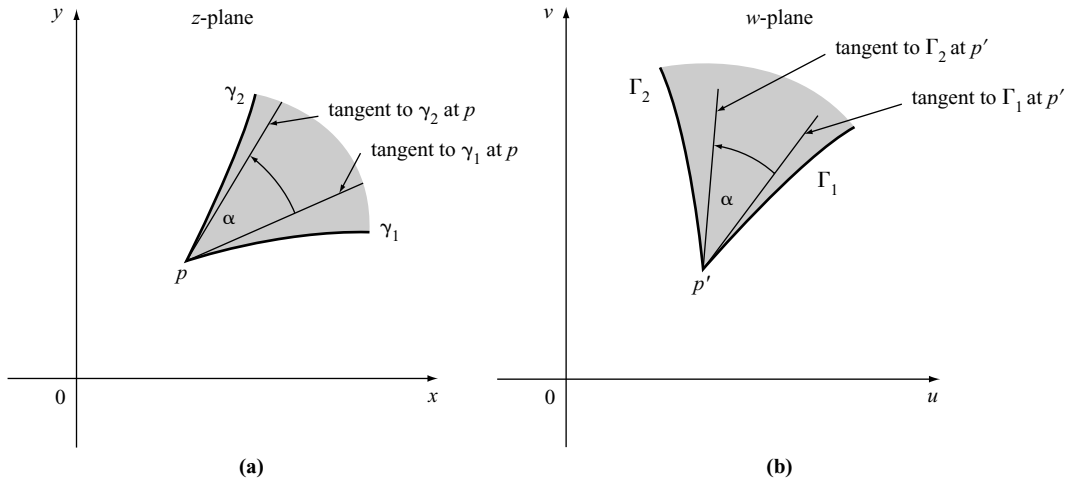

Figure 30.1. The preservation of angle and sense of rotation by a conformal mapping.

the complex z -plane into their **images** Γ_1 and Γ_2 that intersect at a point P' in the complex w -plane, their angle of intersection α is preserved, and the sense of rotation from γ_1 to γ_2 is also preserved when Γ_1 and Γ_2 are mapped, as shown in Figure 30.1(b). It is these two properties, namely the preservation of both the angle and the sense of rotation between intersecting curves in the complex z - and w -planes, that characterizes a complex mapping by an analytic function $w = f(z)$.

30.4 BOUNDARY VALUE PROBLEMS

The Laplace equation describes many physical phenomena, and the requirement that a real valued function Φ satisfies the Laplace equation in a region R , while on the boundary of R it satisfies some prescribed auxiliary conditions, constitutes what is called a **boundary value problem (bvp)**. The most frequently occurring auxiliary conditions, called **boundary conditions**, are of two types.

Dirichlet conditions: the assignment of the prescribed values Φ is to assume on part or all of the boundary.

Neumann conditions: the assignment of the prescribed values the derivative $\partial\Phi/\partial n$ —that is, the derivative of Φ normal to the boundary—is to assume on part or all of the boundary.

In typical boundary value problems a Dirichlet condition is prescribed on parts of the boundary, and a **homogeneous Neumann condition** $\partial\Phi/\partial n = 0$ is prescribed on the remainder of the boundary.

Conformal transformations use two complex planes, the first of which is the z -plane from which a region with a simple shape is to be transformed by a given analytic function $w = f(z)$. The second complex plane is the w -plane generated by the transformation $w = f(z)$, which will, in general, map the first region into a more complicated one. The importance of conformal

transformations when working with boundary value problems is because, if a solution satisfies the Laplace equation in the z -plane, the effect of a conformal transformation will be to produce a solution that also satisfies the Laplace equation in the w -plane. Furthermore, Dirichlet or homogeneous Neumann conditions imposed on boundaries in the z -plane are transformed unchanged to the corresponding boundaries in the w -plane. This has the result that if the solution can be found in the z -plane, it can be transformed at once into the solution in the w -plane, thereby enabling a complicated solution to be found from a simpler one.

In a typical case the temperature satisfies the Laplace equation. In this case, the specification of Dirichlet conditions on part of a boundary is equivalent to specifying the temperature on that part of the boundary, while the specification of homogeneous Neumann conditions on another part of the boundary corresponds to thermal insulation on that part of the boundary because there can be no heat flux across a thermally insulated boundary. In such a case, the curves $u = \text{const.}$ will correspond to isothermals (curves of constant temperature), while their orthogonal trajectories $v = \text{const.}$ will correspond to heat flow lines. Plotting the lines $u = \text{const.}$ and $v = \text{const.}$ then shows graphically the isothermals to each of which can be associated the appropriate temperature. If desired, plotting the curves $v = \text{const.}$ will show the heat flow lines relative to the isothermals.

The idea underlying the use of conformal mapping to solve a boundary value problem for the Laplace equation inside a region with a complicated shape is straightforward. It involves first using separation of variables to find an analytical solution of a related problem in a simply shaped region, like a rectangle or circle, for which the boundaries coincide with constant coordinate lines. The choice of such a simple shape is necessary if a solution is to be found inside the region by means of separation of variables. A conformal mapping is then used to transform the simply shaped region, together with its solution, into a more complicated region of interest, along with its solution, which otherwise would be difficult to find.

30.5 SOME USEFUL CONFORMAL MAPPINGS

In the atlas of diagrams that follow, the boundary of a region in the complex z -plane is shown on the left, and the diagram on the right shows how that boundary is mapped to the w -plane by the given function $w = f(z)$. Important points on the boundary of the region on the left are marked with letters A, B, C, \dots , and their images on the boundary of the transformed region on the right are shown as A', B', C', \dots .

The shaded region in the diagram on the left maps to the shaded region in the diagram on the right. This agrees with the property of conformal mapping that as a point P on the boundary of the region on the left moves around it in a *counterclockwise* sense, so the region that lies to the *left* of the boundary will map to the image region that lies to the *left* as the image point P' of P moves *counterclockwise* around the image boundary. Notice how, in some cases, finite points on one boundary may correspond to points at infinity on the other boundary.

It may happen that an analytic function $w = f(z)$ contains branches and so is multivalued. This occurs, for example, with the **logarithmic function**, and when this function appears in the mappings that follow, the principal branch of the function is used and will be denoted by **Log**. When displaying the mapping of a function with branches, in order to keep the function

single-valued, it is necessary to cut the w -plane. In such cases a cut is to be interpreted as a boundary that may not be crossed, as it separates different values of the solution on either side of the cut. A cut is shown in a diagram as a solid line with a dashed line on either side. A cut is considered to have zero thickness. A typical cut from the origin to the point $w = 1$ on the $u =$ axis is shown in Figure 30.26, where the mapping of a semi-infinite strip by the function $f(z) = \coth(z/2)$ is also shown.

Let a function $f(z)$ be analytic at a point z_0 , where $f'(z_0) = 0$. Then z_0 is called a **critical point** of $f(z)$, and at a critical point the conformal nature of the mapping $w = f(z)$ fails. An important property of critical points can be expressed as follows. Let z_0 be a critical point, and suppose that for some $n > 1$ it is true that $f''(z_0) = f'''(z_0) = \dots = f^{(n-1)}(z_0) = 0$ but that $f^{(n)}(z_0) \neq 0$. Then, if α is the angle between two smooth curves γ_1 and γ_2 that pass through z_0 , the sense of rotation of the angle between their image curves Γ_1 and Γ_2 in the w -plane that pass through the image point P' of P is preserved, but the angle is magnified by a factor n to become $n\alpha$. This can be seen in Figure 30.3, where the function $f(z) = z^2$ has a critical point at the origin because $f'(0) = 0$. However, $f''(0) = 2 \neq 0$, so the right angle in the boundary curve at point B in the diagram on the left is doubled, so when the boundary is mapped to the w -plane on the right, it changes the boundary to the straight line A', B', C' .

Every analytic function will provide a conformal mapping, but only experimentation will show if a chosen analytic function will map simple regions in the z -plane with a boundary formed by lines parallel to the x - and y -axes onto a usefully shaped region in the w -plane.

Entries in the following atlas of mappings may be combined to form composite mappings. This approach is usually necessary when a set of simple mappings is used sequentially to arrive at a single mapping with properties that cannot be found directly from the results in the atlas. An example of a composite mapping is shown in Figure 30.30 at the end of the atlas.

The diagrams that follow show how the boundary at the left is mapped to the boundary on the right by the analytic function $w = f(z)$. However, the diagrams can be used in the reverse sense because the inverse function $z = f^{-1}(w)$ will map the boundary on the right to the one on the left. Whenever such a reverse mapping is used, care must always be taken if the inverse function contains branches, because when this happens the correct branch must be used.

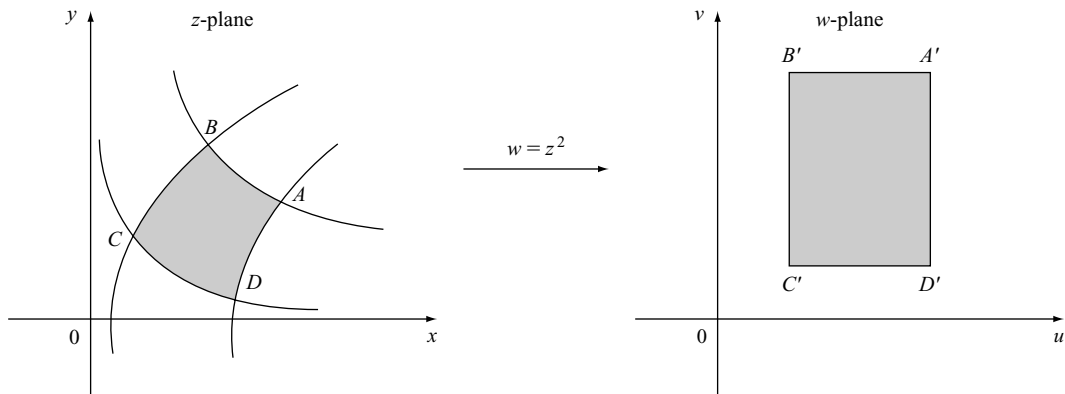

Figure 30.2. The mapping $w = z^2$.

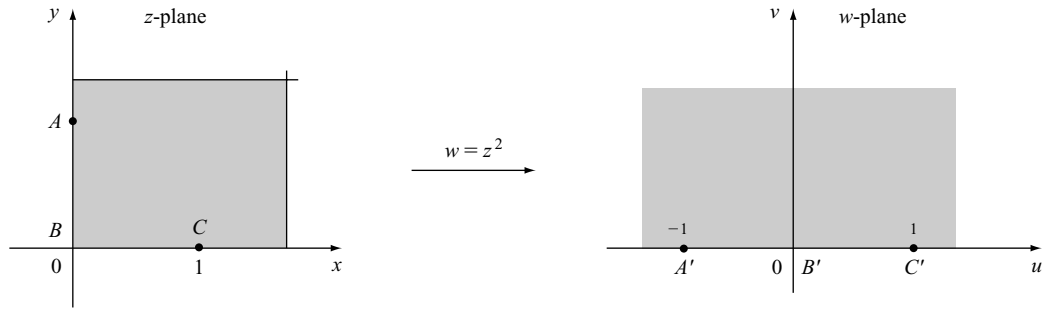

Figure 30.3. The mapping $w = z^2$.

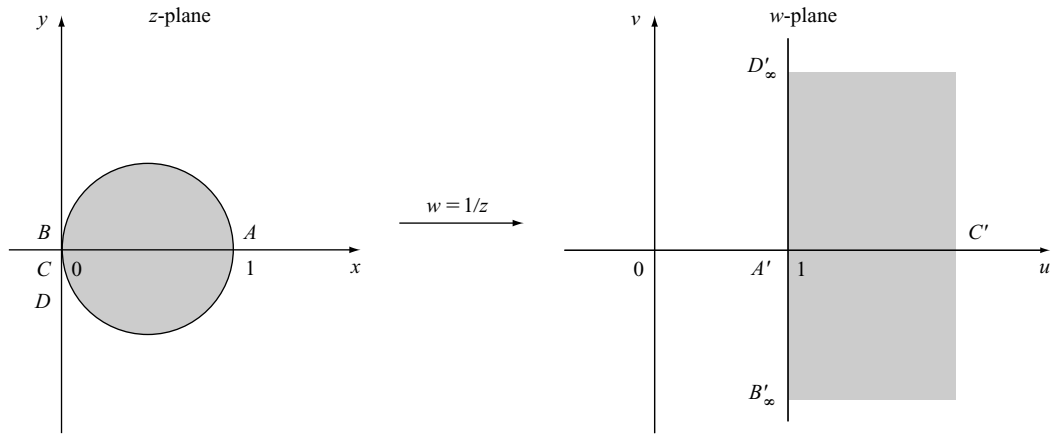

Figure 30.4. The mapping $w = 1/z$.

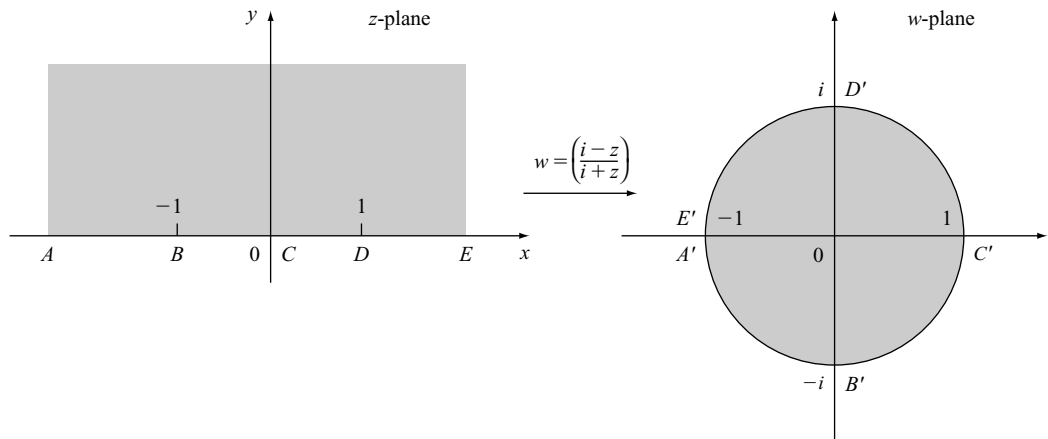

Figure 30.5. The mapping $w = \frac{i-z}{i+z}$.

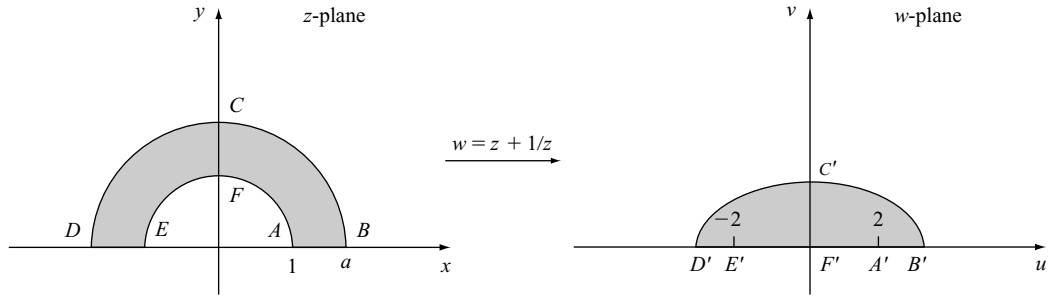

Figure 30.6. The mapping $w = z + 1/z$.

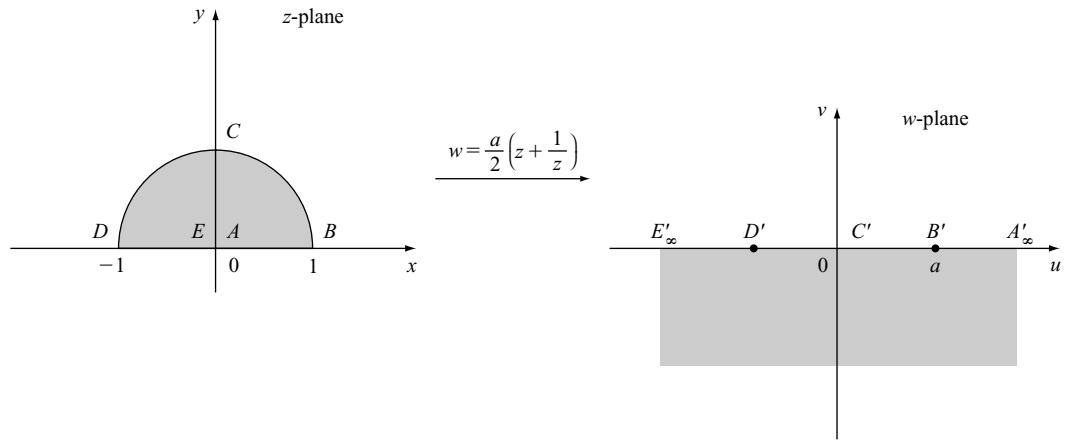

Figure 30.7. The mapping $w = \frac{a}{2} \left(z + \frac{1}{z} \right)$.

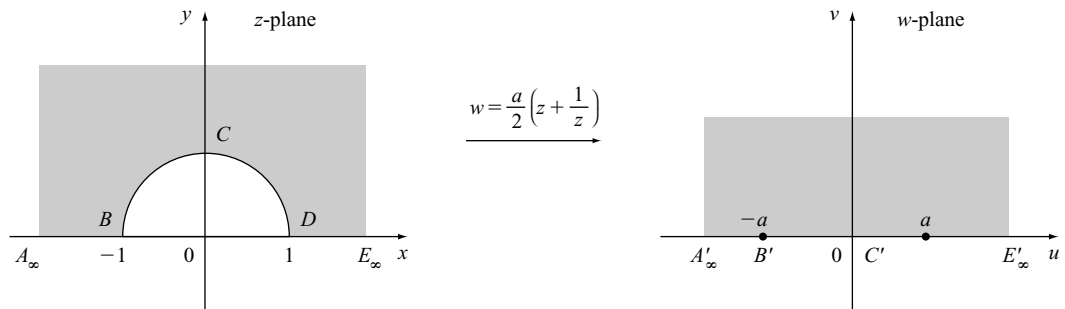

Figure 30.8. The mapping $w = \frac{a}{2} \left(z + \frac{1}{z} \right)$.

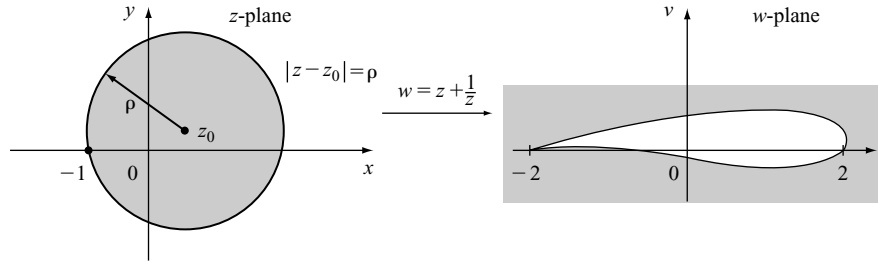

Figure 30.9. The mapping $w = z + \frac{1}{z}$.

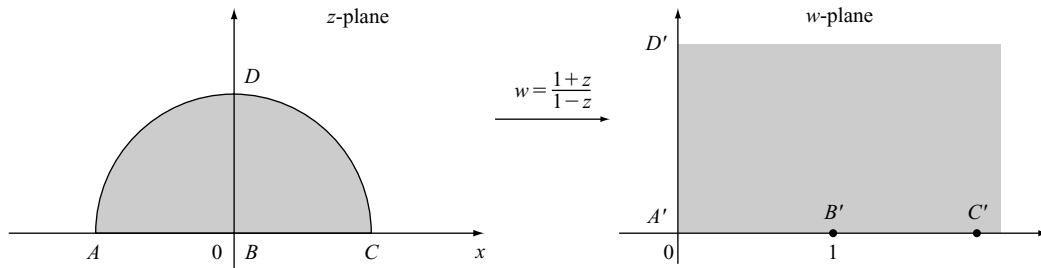

Figure 30.10. The mapping $w = \frac{1+z}{1-z}$.

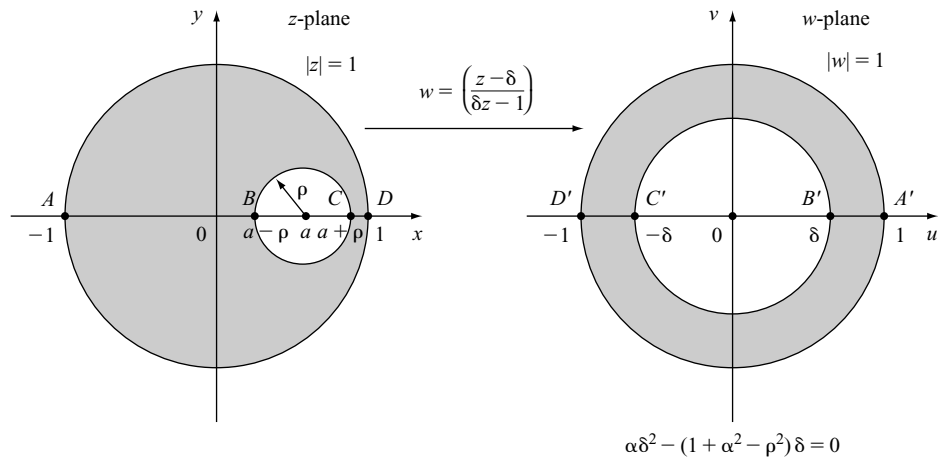

Figure 30.11. The mapping $w = \frac{z-\delta}{\delta z-1}$.

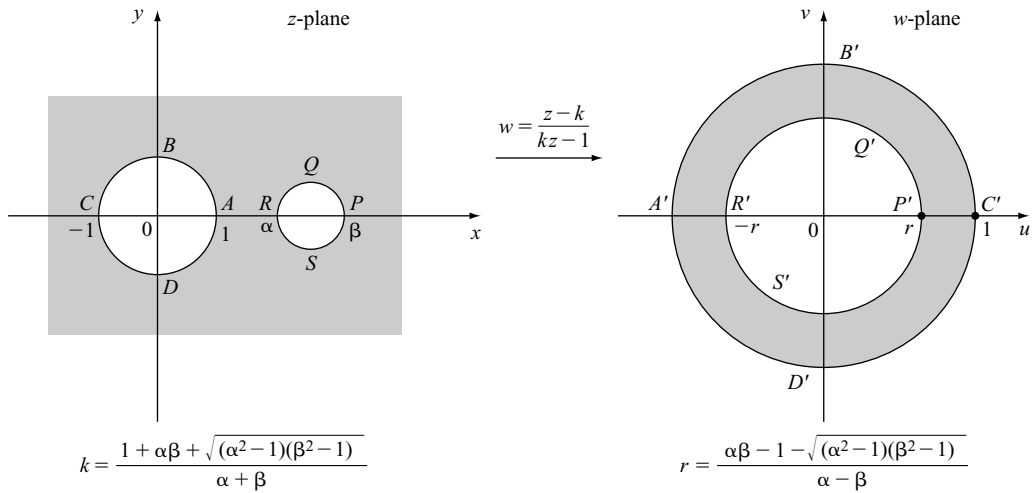

Figure 30.12. The mapping $w = f(z) = \frac{z - k}{kz - 1}$.

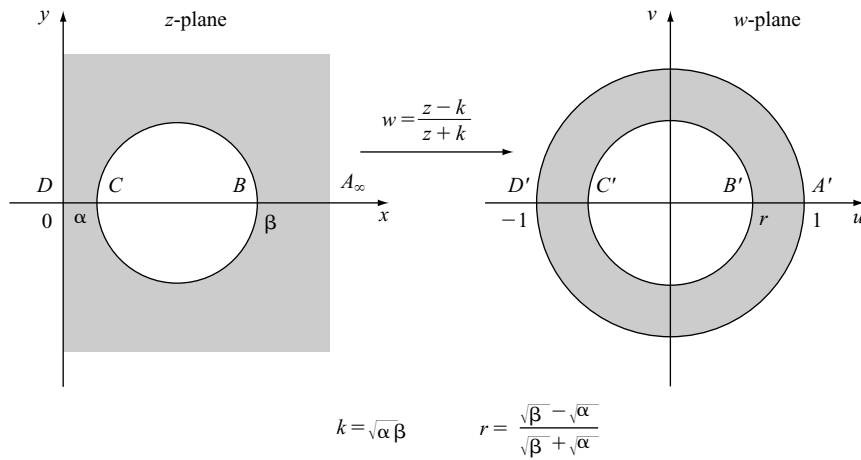

Figure 30.13. The mapping $w = \frac{z - k}{z + k}$.

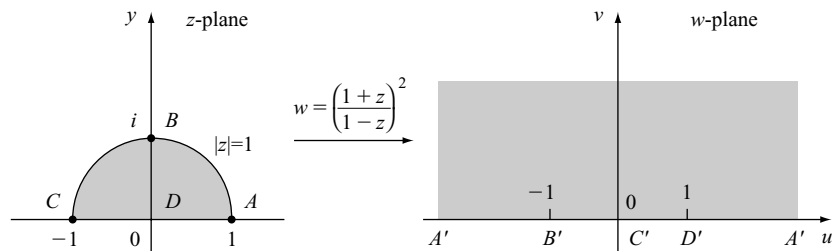

Figure 30.14. The mapping $w = \left(\frac{1 + z}{1 - z}\right)^2$.

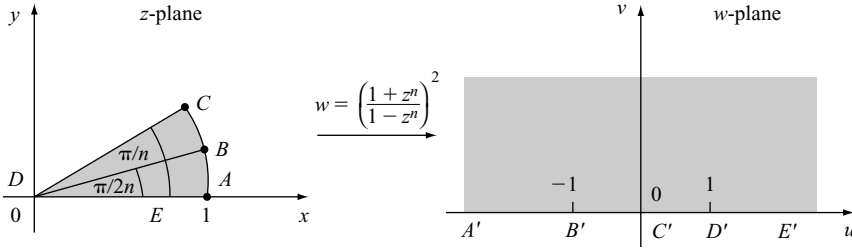

Figure 30.15. The mapping $w = \left(\frac{1+z^n}{1-z^n} \right)^2$.

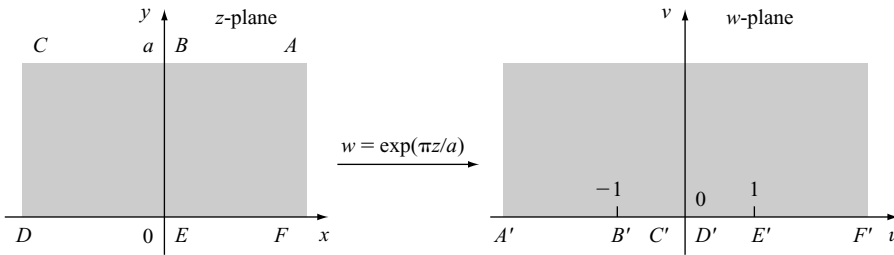

Figure 30.16. The mapping $w = \exp(\pi z/a)$.

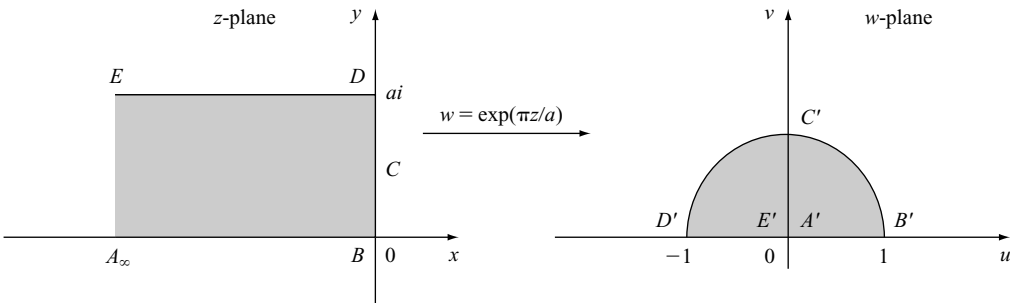

Figure 30.17. The mapping $w = \exp(\pi z/a)$.

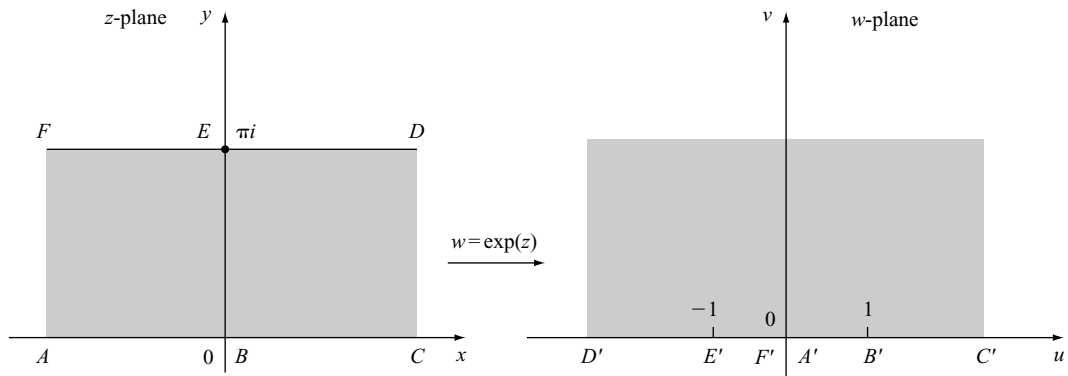

Figure 30.18. The mapping $w = \exp(z)$.

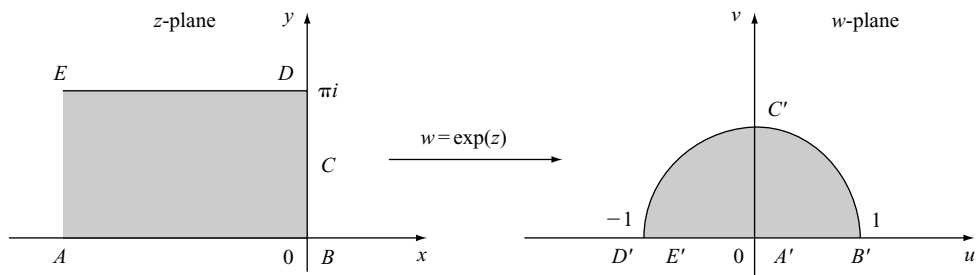

Figure 30.19. The mapping $w = \exp(z)$.

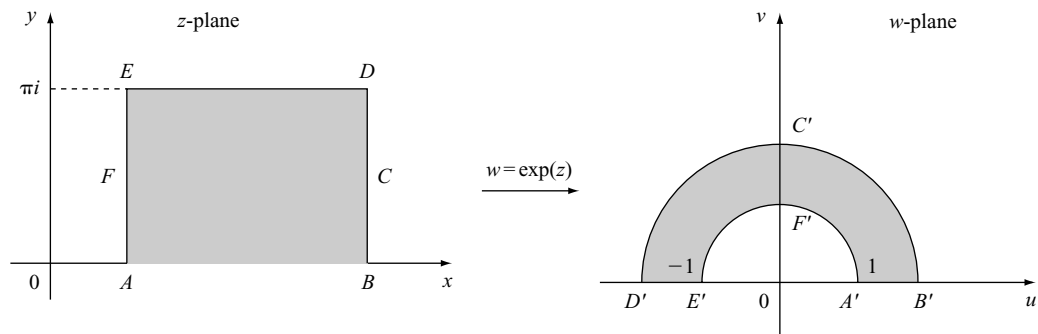

Figure 30.20. The mapping $w = \exp(z)$.

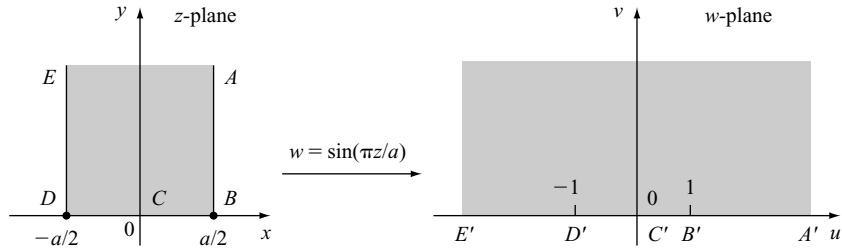

Figure 30.21. The mapping $w = \sin(\pi z/a)$.

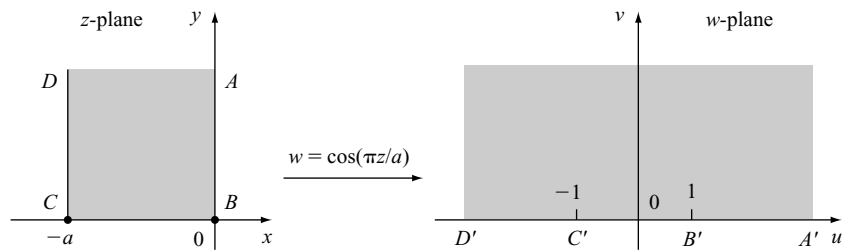

Figure 30.22. The mapping $w = \cos(\pi z/a)$.

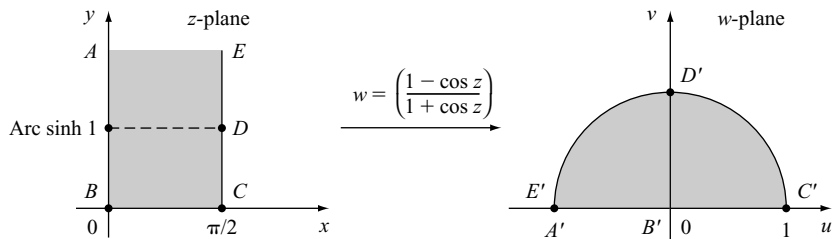

Figure 30.23. The mapping $w = \frac{1 - \cos z}{1 + \cos z}$.

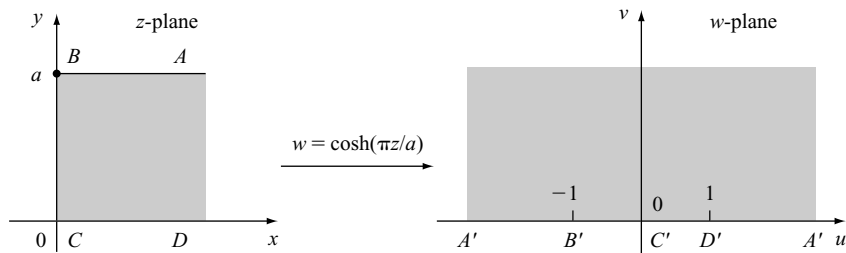

Figure 30.24. The mapping $w = \cosh(\pi z/a)$.

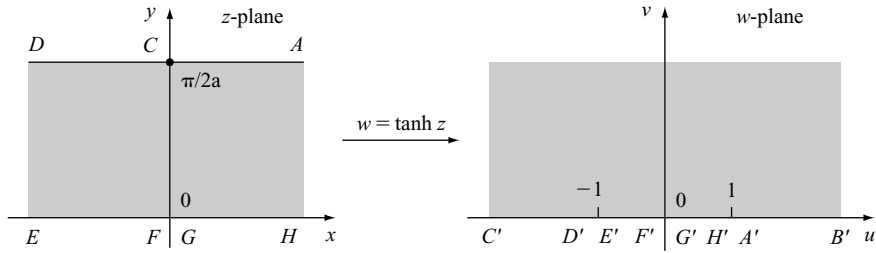

Figure 30.25. The mapping $w = \tanh z$.

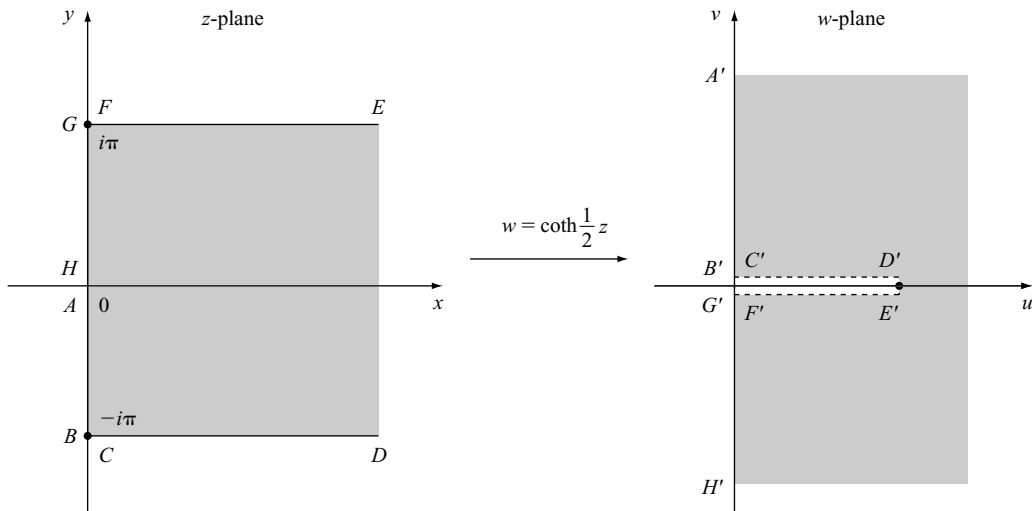

Figure 30.26. The mapping $w = \coth \frac{1}{2} z$.

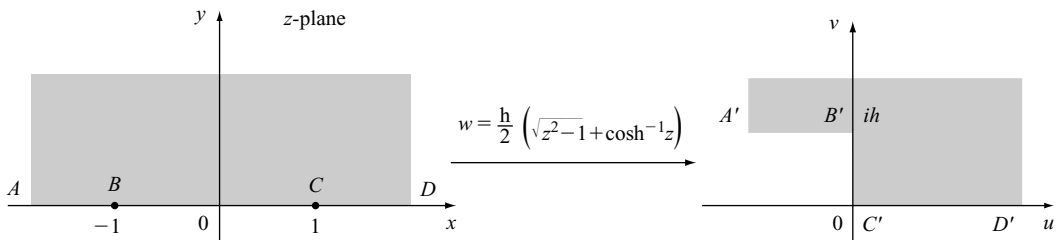

Figure 30.27. The mapping $w = \frac{h}{2} (\sqrt{z^2 - 1} + \cosh^{-1} z)$.

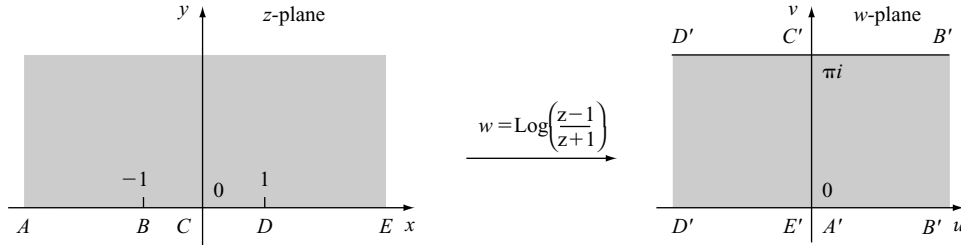

Figure 30.28. The mapping $w = \text{Log}\left(\frac{z-1}{z+1}\right)$.

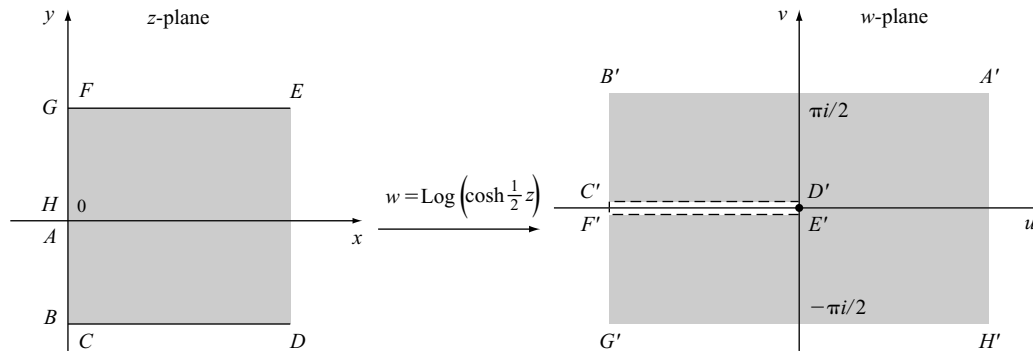

Figure 30.29. The mapping $w = \text{Log}\left(\cosh \frac{1}{2} z\right)$.

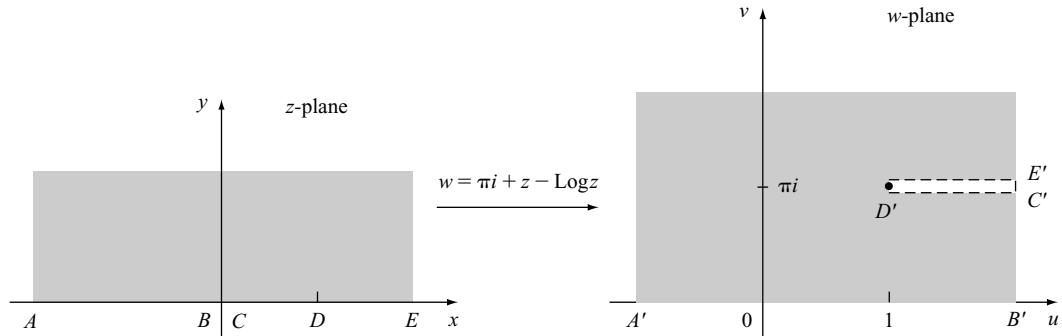

Figure 30.30. The mapping $w = \pi i + z - \text{Log} z$.

The following is a typical example of a composite mapping. It shows how, by using a sequence of simple mappings, the interior of a displaced semi-infinite wedge with internal angle $\pi/2$, indented at its vertex by an arc of radius R , with its vertex at $z = a$, may be mapped onto the upper half of the w -plane. The mapping t_1 shifts the vertex to the origin, mapping t_2 scales the

radius of the indentation to 1, t_3 doubles the angle of the wedge, while t_4 uses the Joukowski transformation (see mapping 30.8 in the atlas) to map the region in t_3 onto the upper half of the w -plane. When combined, this sequence of mappings shows that the direct mapping from the z -plane to the w -plane is given by

$$w = \frac{1}{2} \left[\left(\frac{z-a}{R} \right)^2 + \left(\frac{R}{z-a} \right)^2 \right].$$

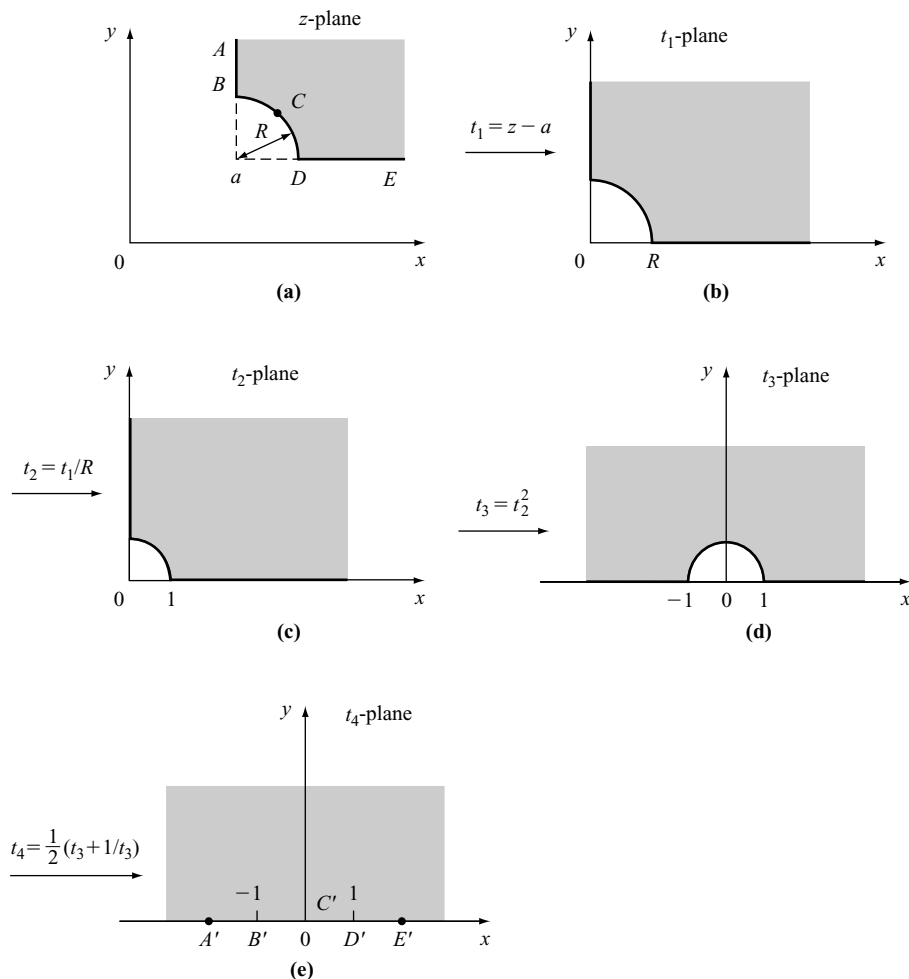

Figure 30.31. The mapping $w = \frac{1}{2} \left[\left(\frac{z-a}{R} \right)^2 + \left(\frac{R}{z-a} \right)^2 \right]$

As a result of this mapping, the points A, B, C, D, E in the z -plane map to the points A', B', C', D', E' in the w -plane.

This mapping shows the solution of the Laplace equation in the interior of the displaced and indented wedge in the z -plane, with Dirichlet conditions on its boundary, is equivalent to solving the Laplace equation in the upper half of the w -plane with the same Dirichlet conditions transferred to the real axis in the w -plane. The solution in the w -plane can be found immediately from the Poisson integral formula for the plane (see section **25.10.1**) and then transformed back to give the solution in the z -plane. Because if point z_1 in the indented wedge maps to the point w_1 in the w -plane, the solution of the Laplace equation at point w_1 in the half-plane maps to the solution of the Laplace equation at point z_1 in the indented wedge. However, if the Dirichlet conditions are piecewise constant, a simpler approach to the solution in the w -plane is possible. See, for example, Section **5.2.3** in the book by Jeffrey in the Complex Analysis references.

Short Classified Reference List

General Tables of Integrals

- Erdélyi, A., *et al.*, *Tables of Integral Transforms*, Vols. I and II, McGraw-Hill, New York, 1954.
- Gradshteyn, I. S., and Ryzhik, I. M., in *Tables of Integrals, Series and Products*, 7th ed. (A. Jeffrey and D. Zwillinger, Eds.), Academic Press, Boston, 1994.
- Marichev, O. I., *Handbook of Integral Transforms of Higher Transcendental Functions, Theory and Algorithmic Tables*, Ellis Horwood, Chichester, 1982.
- Prudnikov A. P., Brychkov, Yu. A., and Marichev, O. I., *Integrals and Series*, Vols. 1–4, Gordon and Breach, New York, 1986–1992.

General Reading

- Klein, M., *Mathematical Thought from Ancient to Modern Times*, Oxford University Press, New York, 1972.
- Zeidler, D., *Oxford User's Guide to Mathematics*, Oxford University Press, London, 2003.

Special Functions

- Abramowitz, M., and Stegun, I. A., *Handbook of Mathematical Functions*, Dover Publications, New York, 1972.
- Andrews, G. E., Askey, R., and Roy, R., *Special Functions*, Cambridge University Press, London, 1995.
- Erdélyi, A., *et al.*, *Higher Transcendental Functions*, Vols. I–III, McGraw-Hill, New York, 1953–55.
- Hobson, E. W., *The Theory of Spherical and Ellipsoidal Harmonics*, Cambridge University Press, London, 1931.
- MacRobert, T. M., *Spherical Harmonics*, Methuen, London, 1947.

- Magnus, W., Oberhettinger, F., and Soni, R. P., *Formulas and Theorems for the Special Functions of Mathematical Physics*, 3rd ed., Springer-Verlag, Berlin, 1966.
- McBride, E. B., *Obtaining Generating Functions*, Springer-Verlag, Berlin, 1971.
- Snow, C., *The Hypergeometric and Legendre Functions with Applications to Integral Equations and Potential Theory*, 2nd ed., National Bureau of Standards, Washington, DC, 1952.
- Watson, G. N., *A Treatise on the Theory of Bessel Functions*, 2nd ed., Cambridge University Press, London, 1944.

Asymptotics

- Copson, E. T., *Asymptotic Expansions*, Cambridge University Press, London, 1965.
- DeBruijn, N. G., *Asymptotic Methods in Analysis*, North-Holland, Amsterdam, 1958.
- Erdélyi, A., *Asymptotic Expansions*, Dover Publications, New York, 1956.
- Olver, F. W. J., *Asymptotics and Special Functions*, Academic Press, New York, 1974.

Elliptic Integrals

- Abramowitz, M., and Stegun, I. A., *Handbook of Mathematical Functions*, Dover Publications, New York, 1972.
- Byrd, P. F., and Friedman, M. D., *Handbook of Elliptic Integrals for Engineers and Physicists*, Springer-Verlag, Berlin, 1954.
- Gradshteyn, I. S., and Ryzhik, I. M., *Tables of Integrals, Series, and Products*, 7th ed. (A. Jeffrey and D. Zwillinger, Eds.), Academic Press, Boston, 2007.
- Lawden, D. F., *Elliptic Functions and Applications*, Springer-Verlag, Berlin, 1989.
- Neville, E. H., *Jacobian Elliptic Functions*, 2nd ed., Oxford University Press, Oxford, 1951.
- Prudnikov, A. P., Brychkov, Yu. A., and Marichev, O. I., *Integrals and Series*, Vol. 3, Gordon and Breach, New York, 1990.

Integral Transforms

- Debnath, L., and Bhatta, D., *Integral Transforms and Their Applications*, 2nd ed., Chapman and Hall/CRC, London, 2007.
- Doetsch, G., *Handbuch der Laplace-Transformation*, Vols. I–IV, Birkhäuser Verlag, Basel, 1950–56.
- Doetsch, G., *Theory and Application of the Laplace Transform*, Chelsea, New York, 1965.
- Erdélyi, A., et al., *Tables of Integral Transforms*, Vols. I and II, McGraw-Hill, New York, 1954.
- Jury, E. I., *Theory and Application of the z-Transform Method*, Wiley, New York, 1964.
- Marichev, O. I., *Handbook of Integral Transforms of Higher Transcendental Functions, Theory and Algorithmic Tables*, Ellis Horwood, Chichester, 1982.
- Oberhettinger, F., and Badii, L., *Tables of Laplace Transforms*, Springer-Verlag, Berlin, 1973.
- Oppenheim, A. V., and Schaffer, R. W., *Discrete Signal Processing*, Prentice-Hall, New York, 1989.
- Prudnikov, A. P., Brychkov, Yu. A., and Marichev, O. I., *Integrals and Series*, Vol. 4, Gordon and Breach, New York, 1992.
- Sneddon, I. N., *Fourier Transforms*, McGraw-Hill, New York, 1951.
- Sneddon, I. N., *The Use of the Integral Transforms*, McGraw-Hill, New York, 1972.
- Widder, D. V., *The Laplace Transforms*, Princeton University Press, Princeton, NJ, 1941.

Orthogonal Functions and Polynomials

- Abramowitz, M., and Stegun, I. A., *Handbook of Mathematical Functions*, Dover Publications, New York, 1972.
- Sansone, G., *Orthogonal Functions*, revised English ed., Interscience, New York, 1959.
- Szegö, G., *Orthogonal Polynomials*, American Mathematical Society, Rhode Island, 1975.

Series

- Jolley, I., R. W., *Summation of Series*, Dover Publications, New York, 1962.
- Zygmund, A., *Trigonometric Series*, 2nd ed., Vols. I and II, Cambridge University Press, London, 1988.

Numerical Tabulations and Approximations

- Abramowitz, M., and Stegun, I. A., *Handbook of Mathematical Functions*, Dover Publications, New York, 1972.
- Hastings, C., Jr., *Approximations for Digital Computers*, Princeton University Press, Princeton, NJ, 1955.
- Jahnke, E., and Emde, F., *Tables of Functions with Formulas and Curves*, Dover Publications, New York, 1943.
- Jahnke, E., Emde, F., and Lösch, F., *Tables of Higher Functions*, 6th ed., McGraw-Hill, New York, 1960.

Ordinary and Partial Differential Equations

- Birkhoff, G., and Gian-Carlo, R., *Ordinary Differential Equations*, 4th ed., Wiley, New York, 1989.
- Boyce, W. E., and Di Prima, R. C., *Elementary Differential Equations and Boundary Value Problems*, 5th ed., Wiley, New York, 1992.
- Debnath, L., *Nonlinear Partial Differential Equations for Scientists and Engineers*, 2nd ed., Birkhauser, Boston, 2005.
- Du Chateau, Y., and Zachmann, D., *Applied Partial Differential Equations*, Harper & Row, New York, 1989.
- Keener, J. P., *Principles of Applied Mathematics*, Addison-Wesley, New York, 1988.
- Logan, J. D., *Applied Mathematics*, 3rd ed., Wiley, New York, 2006.
- Strauss, W. A., *Partial Differential Equations*, Wiley, New York, 1992.
- Zachmanoglou, E. C., and Thoe, D. W., *Introduction to Partial Differential Equations and Applications*, William and Wilkins, Baltimore, 1976.
- Zauderer, E., *Partial Differential Equations of Applied Mathematics*, 2nd ed., Wiley, New York, 1989.
- Zwillinger, D., *Handbook of Differential Equations*, Academic Press, New York, 1989.

Numerical Analysis

- Ames, W. F., *Nonlinear Partial Differential Equations in Engineering*, Vol. 1, Academic Press, New York, 1965.
- Ames, W. F., *Nonlinear Partial Differential Equations in Engineering*, Vol. 2, Academic Press, New York, 1972.

- Ames, W. F., *Numerical Methods for Partial Differential Equations*, Nelson, London, 1977.
- Atkinson, K. E., *An Introduction to Numerical Analysis*, 2nd ed., Wiley, New York, 1989.
- Fröberg, C. E., *Numerical Methods: Theory and Computer Applications*, Addison-Wesley, New York, 1985.
- Golub, G. H., and Van Loan, C. E., *Matrix Computations*, Johns Hopkins University Press, Baltimore, 1984.
- Henrici, P., *Essentials of Numerical Analysis*, Wiley, New York, 1982.
- Johnson, L. W., and Riess, R. D., *Numerical Analysis*, Addison-Wesley, New York, 1982.
- Morton, K. W., and Mayers, D. F., *Numerical Solution of Partial Differential Equations*, Cambridge University Press, London, 1994.
- Press, W. H., Flannery, B. P., Teukolsky, S. A., and Vetterling, W. T., *Numerical Recipes*, Cambridge University Press, London, 1986.
- Richtmeyer, R., and Morton, K., *Difference Methods for Initial Value Problems*, Interscience, New York, 1967.
- Schwarz, H. R., *Numerical Analysis: A Comprehensive Introduction*, Wiley, New York, 1989.

Complex Analysis

- Churchill, R. V., Brown, J. W., and Verhey, R., *Complex Variables with Applications*, 5th ed., New York, McGraw-Hill, 1990.
- Jeffrey, A., *Complex Analysis and Applications*, 2nd ed., Chapman and Hall/CRC, London, 2006.
- Matthews, J. H., and Howell, R. W., *Complex Analysis for Mathematics and Engineering*, Jones and Bartlett, Sudbury, MA, 1997.
- Saff, E. B., and Snider, A. D., *Fundamentals of Complex Analysis for Mathematics, Science and Engineering*, 2nd ed., Upper Saddle River, NJ, Prentice Hall, 1993.
- Zill, D. G., and Shanahan, P. D., *A First Course in Complex Analysis with Applications*, Jones and Bartlett, Sudbury, MA, 1997.

Index

A

Abel's test, for convergence, 74, 103
Abel's theorem, 81
Absolute convergence
 infinite products, 77–78
 series, 72
Absolute value
 complex number, 28
 integral quality, 99
Acceleration of convergence, 49–50
Addition, *see* Sum
Adjoint matrix, 59
Advection equation, 460
Algebraic function
 definition, 153
 derivatives, 149–150
 indefinite integrals, 5–7, 154–174
 nonrational, *see* Nonrational algebraic functions
 rational, *see* Rational algebraic functions
Algebraic jump condition, 464
Algebraically homogeneous differential equation, 376
Alternant, 55
Alternating series, 49, 74
Amplitude, of Jacobian elliptic function, 247
Analytic functions, 509, 513
Annulus
 geometry of, 19
 properties of, 19
Annulus, of circle, 18
Antiderivative, 96–97, 426, *see also* Indefinite integral
Arc
 circular, 17–18
 length, 106–107
 line integral along, 427

Area

 under a curve, 105
 geometric figures, 12–26
 surface, 428
 surface of revolution, 107
Argument, of complex number, 109
Arithmetic–geometric inequality, 30
Arithmetic–geometric series, 36, 74
Arithmetic series, 36
Associated Legendre functions, 316–317
Associative laws, of vector operations, 417, 421, 422
Asymptotic expansions
 definition, 89–91
 error function, 257
 Hermite polynomial, 332
 normal distribution, 253–254
 order notation, 88–89
 spherical Bessel functions, 306
Asymptotic representation
 Bernoulli numbers, 46–47
 Bessel functions, 294, 299
 gamma function, 233
 $n!$, 233
Asymptotic series, 93–95

B

Bernoulli distribution, *see* Binomial distribution
Bernoulli number
 asymptotic relationships for, 45
 definitions, 40, 42
 list of, 41, 42
 occurrence in series, 43–44
 relationships with Euler numbers and polynomials, 42
 series representations for, 43
 sums of powers of integers, 36–37
Bernoulli polynomials, 40, 43, 46–47
Bernoulli's equation, 374–375
Bessel functions, 289–308
 asymptotic representations, 294, 299
 definite integrals, 303–304
 expansion, 292
 of fractional order, 292–293
 graphs, 295
 indefinite integrals, 302–303
 integral representations, 302
 modified, 294–297
 of first and second kind, 296
 relationships between, 299–302
 series expansions, 290–292, 297–298
 spherical, 304–307
 zeros, 294
Bessel's equation
 forms of, 289–290, 394–396
 partial differential equations, 389
Bessel's inequality, 93
Bessel's modified equation, 294–297, 394–396
Beta function, 235
Big O, 88
Binomial coefficients, 32
 definition, 31
 generation, 31–32

- Binomial coefficients
(*continued*)
permutations, 67
relationships between, 34
sums of powers of integers,
36–37
table, 33
- Binomial expansion, 32, 75
- Binomial distribution
approximations in, 254–255
mean value of, 254
variance of, 254
- Binomial series, 10
- Binomial theorem, 32–34
- Bipolar coordinates, 438–440
- Bisection method, for
determining roots, 114–115
- Bode's rule, for numerical
integration, 365
- Boundary conditions, 387
Dirichlet conditions, 511
Neumann conditions, 511
- Boundary value problems,
511–512
ordinary differential
equations, 377, 410–413
partial differential equations,
381–382, 383
- Bounded variation, 90
- Burger's equation, 467
- Burger's shock wave, 468–470
- C**
- Cardano formula, 113
- Carleman's inequality, 31
- Cartesian coordinates, 419–482
- Cartesian representation, of
complex number, 109
- Cauchy condition, for partial
differential equations, 449
- Cauchy criterion, for
convergence, 72, 80
- Cauchy–Euler equation, 393
- Cauchy form, of Taylor series
remainder term, 87
- Cauchy integral test, 74
- Cauchy n th root test, 73
- Cauchy principal value, 102
- Cauchy problem, 449
- Cauchy–Riemann equations,
509–510
- Cauchy–Schwarz–Buniakowsky
inequality, 29
- Cayley–Hamilton theorem, 61
- Center of mass (gravity), 107
- Centroid, 12–24, 106, 108
- Chain rule, 95, 426
- Characteristic curve, 459
- Characteristic equation, 60, 61
- Characteristic form, of partial
differential equation, 459
- Characteristic method, for
partial differential
equations, 458–462
- Characteristic parameter, 242
- Characteristic polynomial, 378,
379, 380, 383
- Chebyshev polynomial,
320–324, 501–502
- Chebyshev's inequality, 30
- Circle geometry, 17–19
- Circle of convergence, 82
- Circulant, 56
- Circumference, 17
- Closed-form summation,
285–288
- Closed-type integration
formula, 363–367
- Coefficients
binomial, *see* Binomial
coefficient
Fourier, 89, 275–284
multinomial, 68
polynomial, 103–104
undetermined, 69–71
- Cofactor, 51
- Combinations, 67–68
- Commutative laws, of vector
operations, 417, 418, 421
- Comparison integral inequality,
99
- Comparison test, for
convergence, 73
- Compatibility condition, for
partial differential
equations, 450
- Complementary error function,
257
- Complementary function, linear
differential equation, 341
- Complementary minor, 54
- Complementary modulus, 242
- Complete elliptic integral, 242
- Complex conjugate, 28
- Complex Fourier series, 91, 284
- Complex numbers
Cartesian representation, 109
conjugate, 28
de Moivre's theorem, 110
definitions, 109–110
difference, 55, 27–28, 134–135
equality, 27
Euler's formula, 110
identities, 1, 77
imaginary part, 27
imaginary unit, 27
inequalities, 28, 29
modulus, 28
modulus-argument form, 109
principal value, 110
quotient, 28
real part, 27
roots, 111–112
sums of powers of integers, 36
triangle inequality, 28
- Components, of vectors, 416,
419–420
- Composite integration formula,
364
- Composite mapping, 513, 522
- Compressible gas flow, 457
- Computational molecule, 506
- Conditionally convergent series,
72
- Cone geometry, 21–23
- Confluent hypergeometric
equation, 403
- Conformal mapping, 512–524
- Conformal transformations,
510–511
- Conservation equation, 457–458
- Conservative field, 428
- Constant
 e , 3
Euler–Mascheroni, 232
Euler's, 232
gamma, 3
of integration, 97
 $\log_{10} e$, \log_e , 3
method of undetermined
coefficients, 390
pi, 3
- Constitutive equation, 457
- Contact discontinuity, 464
- Convergence
acceleration of, 49

- of functions, *see* Roots of functions
- improper integrals, 101–103
- infinite products, 77–78
- Convergence of series
 - absolute, 72
 - Cauchy criterion for, 72
 - divergence, 72
 - Fourier, 89–90, 275–283
 - infinite products, 77–78
 - partial sum, 72
 - power, 82
 - Taylor, 86–89
 - tests, 72–74
 - Abel's test, 74
 - alternating series test, 49, 74
 - Cauchy integral test, 74
 - Cauchy n th root test, 73
 - comparison test, 73
 - Dirichlet test, 74
 - limit comparison test, 73
 - Raabe's test, 73
 - types of, 72
 - uniform convergence, 79–81
- Convex function, 30–31
- Convexity, 31
- Convolution theorem, 339
- Coordinates
 - bipolar, 438–440
 - Cartesian, 416, 436
 - curvilinear, 433–436
 - cylindrical, 436–437, 441, 442–443
 - definitions, 433–435
 - elliptic cylinder, 442–443
 - oblate spheroidal, 444–445
 - orthogonal, 433–445
 - parabolic cylinder, 441
 - paraboloidal, 442
 - polar, 436–437
 - prolate spheroidal, 443–444
 - rectangular, 436
 - spherical, 437–438
 - spheroidal, 443–444
 - toroidal, 440
- Cosine
 - Fourier series, 277–283
 - Fourier transform, 357–362
- Cosine integrals, 261–264
- Cramer's rule, 55
- Critical points, 510, 513
- Cross product, 421–422
- Cube, 14
- Cubic spline interpolation, 500
- Curl, 429–430, 435
- Curvilinear coordinates, *see* Coordinates
- Cylinder geometry, 19–21
- Cylindrical coordinates, 436–437, 441, 442–443
- Cylindrical wave equation, 467
- D**
- D'Alembert's ratio test, 72
- D'Alembert solution, 488
- De Moivre's theorem, 110–111
- Definite integral
 - applications, 104–108
 - Bessel functions, 303–304
 - definition, 97
 - exponential function, 270–271
 - Hermite polynomial, 331–332
 - hyperbolic functions, 273
 - incomplete gamma function, 236–237
 - involving powers of x , 265–267
 - Legendre polynomial, 366
 - logarithmic function, 273–274
 - trigonometric functions, 267–269
 - vector functions, 427
- Delta amplitude, 247
- Delta function, 151, 494
- Derivative
 - algebraic functions, 149–150
 - approximation to, 504
 - directional, 431
 - error function, 257
 - exponential function, 149–150
 - Fourier series, 92
 - function of a function, 4
 - hyperbolic functions, 151
 - inverse hyperbolic functions, 152
 - inverse trigonometric functions, 150–151
 - Jacobian elliptic function, 250
 - Laplace transform of, 338
 - logarithmic function, 149–150
 - matrix, 64–65
 - power series, 82
 - trigonometric functions, 150
- vector functions, 423–424
- Determinant
 - alternant, 55
 - basic properties, 53
 - circulant, 56
 - cofactors, 51
 - Cramer's rule, 55
 - definition, 50–51
 - expansion of, 50–51
 - Hadamard's inequality, 54–55
 - Hadamard's theorem, 54
 - Hessian, 57
 - Jacobian, 56
 - Jacobi's theorem, 53–54
 - Laplace expansion, 51
 - minor, 51
 - Routh–Hurwitz theorem, 57–58
 - Vandermonde's, 55
 - Wronskian, 372–373
- Diagonal matrix, 58, 61–62
- Diagonally dominant matrix, 55, 60
- Diagonals, of geometric figures, 12–15
- Difference equations
 - z -transform and, 498
 - numerical methods for, 499–507
- Differential equations
 - Bessel's, *see* Bessel functions; Bessel's equation
 - Chebyshev polynomials, 320–325
 - Hermite polynomials, 329
 - Laguerre polynomials, 325
 - Legendre polynomials, 310, 313, 394
 - ordinary, *see* Ordinary differential equations
 - partial, *see* Partial differential equations
 - solution methods, 377–413, 451–472
- Differentiation
 - chain rule, 95
 - elementary functions, 3, 149
 - exponential function, 149
 - hyperbolic functions, 151
 - integral containing a parameter, 4
 - inverse hyperbolic functions, 152

- Differentiation (*continued*)
 inverse trigonometric functions, 150–151
 logarithmic functions, 149
 product, 4, 95
 quotient, 4, 95
 rules of, 4, 95–96
 sums of powers of integers, 3
 term by term, 81
 trigonometric functions, 150
- Digamma function, 234
- Dini's condition, for Fourier series, 90
- Dirac delta function, 340
- Direction cosine, 416
- Direction ratio, 416
- Directional derivative, 431
- Dirichlet condition, 511, 524
 Fourier series, 90
 Fourier transform, 353
 partial differential equations, 449, 460
- Dirichlet integral
 representation, 92
- Dirichlet kernel, 92
- Dirichlet problem, 450
- Dirichlet's result, 90
- Dirichlet's test, for convergence, 74, 103
- Dirichlet's theorem, 81
- Discontinuous functions, and
 Fourier series, 285–288
- Discontinuous solution, to
 partial differential equation, 462–464
- Discriminant, 381
- Dispersive effect, 468
- Dissipative effect, 468
- Distributions, 253–257
- Distributive laws, of vector operations, 418, 421, 422
- Divergence
 infinite products, 77
 vectors, 428, 430, 435
- Divergence form, of
 conservation equation, 458
- Divergent series, 72, 73, 94
- Division algorithm, 114
- Dot product, 420
- Double arguments, in Jacobian elliptic function, 242
- Dummy variable, for integration, 97
- E**
- e*, *see also* Exponential function
 constant, 3
 definitions, 123
 numerical value, 2, 113
 series expansion for, 113
 series involving, 75
- Economization of series, 501–503
- Eigenfunction
 Bessel's equations, 394–396
 partial differential equations, 447
- Eigenvalues, 62
 Bessel's equations, 390–395
 definition, 40
 diagonal matrix, 66
 partial differential equations, 386
- Eigenvectors, 60, 62, 66
- Elementary function, 241
- Ellipsoid geometry, 25
- Elliptic cylindrical coordinates, 442–444
- Elliptic equation solutions, 475–482
- Elliptic function
 definition, 250
 Jacobian, 250–251
- Elliptic integrals, 241–248
 definitions, 231–234
 series representation, 243–245
 tables of values, 243–244, 246
 types, 241, 265
- Elliptic partial differential equations, 447
- Entropy conditions, 464
- Error function, 253–257
 derivatives, 249
 integral, 201–207
 relationship with normal probability distribution, 253
 table of values, 255
- Euler integral, 231
- Euler–Mascheroni constant, 232
- Euler–Maclaurin summation formula, 48
- Euler numbers
 definitions, 40–42
 list of, 41
 relationships with Bernoulli numbers, 42
 series representation, 43
- Euler polynomial, 46–47
- Euler's constant, 232
- Euler's formula, 110
- Euler's method, for differential equations, 404
- Even function
 definition, 124
 trigonometric, 125
- Exact differential equation, 325
- Exponential Fourier series, 279
- Exponential Fourier transform, 353
- Exponential function
 derivatives, 149
 Euler's formula, 110
 inequalities involving, 147
 integrals, 4, 7, 8, 168–171
 definite, 265
 limiting values, 147
 series representation, 123
- Exponential integral, integrands involving, 176, 274
- F**
- Factorial, asymptotic approximations to, 223, *see also* Gamma function
- False position method, for determining roots, 115
- Faltung theorem, 339, 355
- Finite difference methods, 505–507
- Finite sum, 32–39
- First fundamental theorem of calculus, 97
- Fourier–Bessel expansions, 307–308
- Fourier–Chebyshev expansion, 321
- Fourier convolution, 354–355
- Fourier convolution theorem, inverse, 355
- Fourier cosine transform, 357–358
- Fourier–Hermite expansion, 330
- Fourier–Laguerre expansion, 326
- Fourier–Legendre expansion, 310
- Fourier series, 89–90
 Bessel's inequality, 93

- bounded variation, 90
 - coefficients, 67, 275–278
 - complex form, 91
 - convergence, 72–73
 - definitions, 89–93
 - differentiation, 64, 93, 95
 - Dini's condition, 90
 - Dirichlet condition, 90
 - Dirichlet expression for n 'th partial sum, 92
 - Dirichlet kernel, 92
 - discontinuous functions, 285–288
 - examples, 260–268
 - forms of, 275–294
 - half-range forms, 82–83
 - integration, 96
 - Parseval identity, 93
 - Parseval relations, 275–284
 - periodic extension, 285
 - Riemann–Lebesgue lemma, 91
 - total variation, 90
 - Fourier sine transform, 358
 - Fourier transform, 353–362
 - basic properties, 354, 358
 - convolution operation, 339
 - inversion integral, 354
 - sine and cosine transforms, 358
 - transform pairs, 353, 355
 - tables, 356–357, 359–362
 - Fractional order, of Bessel functions, 292–293, 298–299
 - Fresnel integral, 261–264
 - Frobenius method, for differential equations, 398–402
 - Frustrum, 22
 - Function
 - algebraic functions, 153
 - beta, 235
 - complementary error, 257
 - error, 257
 - even, 124
 - exponential function, 123, 147, 149
 - gamma, 231, 232, 233
 - hyperbolic, 109
 - inverse hyperbolic, 9, 12, 141, 142
 - inverse trigonometric, 8, 11, 139
 - logarithmic, 104, 121, 147
 - odd, 114, 124
 - periodic, 124
 - psi (digamma), 234
 - rational, 103
 - transcendental, 153
 - trigonometric, 109
 - Functional series, 79–81
 - Abel's theorem, 81
 - definitions, 73–74
 - Dirichlet's theorem, 81
 - region of convergence, 79, 81, 82
 - termwise differentiation, 74
 - termwise integration, 74
 - uniform convergence, 79
 - Weierstrass M test, 80
 - Fundamental interval, for Fourier series, 265
 - Fundamental theorems of calculus, 97
- G**
- Gamma function
 - asymptotic representation, 233, 294
 - definition, 221
 - graph, 235
 - identities, 77
 - incomplete, *see* Incomplete gamma function
 - properties, 232–233
 - series, 77
 - special numerical values, 223
 - table of values, 243–244
 - Gauss divergence theorem, 429, 452
 - Gauss mean value theorem for harmonic functions
 - in plane, 473
 - in space, 474
 - Gaussian probability density function, 253–254
 - Gaussian quadrature, 366–367
 - General solution, of differential equations, 340, 371
 - Generalized Laguerre polynomials, 327–329
 - Generalized L'Hôpital's rule, 96
 - Generalized Parseval identity, 93
 - Generating functions, for orthogonal polynomials, 325, 435
 - Geometric figures, reference data, 30
 - Geometric series, 36, 74
 - Geometry, applications of definite integrals, 96, 99
 - Gerschgorin circle theorem, 67
 - Gradient, vector operation, 435
 - Green's first theorem, 430
 - Green's function
 - definition, 385–389
 - for solving initial value problems, 386
 - linear inhomogeneous equation using, 385
 - two-point boundary value problem using, 387–388
 - Green's second theorem, 430
 - Green's theorem in the plane, 430
- H**
- Hadamard's inequality, 54
 - Hadamard's theorem, 54
 - Half angles
 - hyperbolic identities, 132–137
 - trigonometric identities, 124–132
 - Half arguments, in Jacobian elliptic functions, 248
 - Half-range Fourier series, 89–93
 - Harmonic conjugates, 510
 - Harmonic function, 471, 510
 - Heat equation, 436
 - Heaviside step function, 338, 494
 - Hermite polynomial, 329–332
 - asymptotic expansion, 332
 - definite integrals, 331–332
 - powers of x , 331
 - series expansion of, 331
 - Hermitian matrix, 60
 - Hermitian transpose, 59
 - Hessian determinant, 57
 - Helmholtz equation, 304, 436–438, 440–444
 - Holder's inequality, 28–29
 - Homogeneous boundary conditions, 387
 - Homogeneous equation differential, 376, 377

- Homogeneous equation
 (*continued*)
 differential linear, 327–332
 partial differential, 447
 Hyperbolic equation solutions,
 451, 462
 Hyperbolic functions
 basic relationships, 125–127
 definite integrals, 265
 definitions, 132
 derivatives, 151–152
 graphs, 133
 half-argument form, 137
 identities, 2, 111, 112, 132,
 134, 137
 inequalities, 147
 integrals, 9, 93, 179, 181
 inverse, *see* Inverse
 hyperbolic functions
 multiple argument form,
 135–136
 powers, 136
 series, 12, 145
 sum and difference, 134
 Hyperbolic partial differential
 equation, 448
 Hyperbolic problem, 451–453
 Hypergeometric equation,
 403–404
- I**
- Idempotent matrix, 60
 Identities
 complex numbers, 2, 110–111
 constants, 3
 e , 2
 gamma function, 77
 Green's theorems, 430
 half angles, 130–131, 137
 hyperbolic functions, 2, 121,
 134–137
 inverse hyperbolic, 142,
 143–144
 inverse trigonometric
 functions, 139, 142, 143
 Jacobi elliptic, 247
 Lagrange trigonometric, 130
 Lagrange's, 29
 logarithmic, 139, 142
 multiple angles, 130, 135, 136
 Parseval's, 93
 trigonometric, 1, 121, 128–132
 vector, 431
- Identity matrix, 58
 Ill-posed partial differential
 equation, 449
 Imaginary part, of complex
 number, 27
 Imaginary unit, 27
 Improper integral
 convergence, 101–103
 definitions, 101–102
 divergence, 101–102
 evaluation, 101–102
 first kind, 101
 second kind, 101
 Incomplete elliptic integral, 242
 Incomplete gamma function
 definite integrals, 236–237
 functional relations, 236
 series representations, 236
 Indefinite integral, *see also*
 Antiderivative
 algebraic functions, 5–7,
 153–174
 Bessel functions, 302–303
 definition, 97, 426
 exponential function, 175–179
 hyperbolic functions, 189–199
 inverse hyperbolic functions,
 201–205
 inverse trigonometric
 functions, 225–229
 logarithmic function, 181–187
 nonrational function, 166–174
 rational functions, 154–166
 simplification by substitution,
 207–209
 trigonometric functions,
 177–179, 207–209
 Indicial equation, 399
 Induction
 mathematical, 38
 Inequalities
 absolute value integrals, 99
 arithmetic–geometric, 30
 Bessel's, 93
 Carleman's, 31
 Cauchy–Schwarz–
 Buniakowsky inequality,
 29
 Chebyshev, 30
 comparison of integrals, 99
 exponential function, 147
 Hadamard's, 54
 Holder, 30
 hyperbolic, 148
 Jensen, 31
 logarithmic, 147
 Minkowski, 29–30
 real and complex, 28–32
 trigonometric, 148
 Infinite products
 absolute convergence, 78
 convergence, 77
 divergence, 77
 examples, 78–79
 Vieta's formula, 79
 Wallis's formula, 79
 Infinite series, 74–77
 Inhomogeneous differential
 equation ordinary, 382–389
 Initial conditions, 377
 Initial point, of vector, 416
 Initial value problem, 340–341,
 377, 386, 447–449
 Inner product, 420–421
 Integral
 definite, *see* Definite integral
 elliptic, *see* Elliptic integral
 of error function, 258–259
 of Fourier series, 92
 Fresnel, 261–262
 improper, *see* Improper
 integral
 indefinite, *see* Indefinite
 integral
 inequalities, 99
 inversion, 338, 354, 358
 of Jacobian elliptic functions,
 250, 251
 line, 427–428
 mean value theorem for
 integrals, 99
 n 'th repeated, 258–259
 particular, *see* Particular
 integral
 standard, 4–10
 surface, 428
 volume, 431
 Integral form
 conservation equation, 458
 Taylor series, 86
 Integral method, for differential
 equations, 400
 Integrating factor, 373
 Integration
 by parts, 97, 97–99
 Cauchy principal value, 102

- contiguous intervals, 97
 convergence of improper type, 102–103
 definitions, 97
 differentiation with respect to a parameter, 99
 of discontinuous functions, 85
 dummy variable, 97
 first fundamental theorem, 97
 limits, 97
 of matrices, 65
 numerical, 363–369
 of power series, 82
 rational functions, 103–104
 reduction formulas, 99
 Romberg, 367–369
 rules of, 95
 second fundamental form, 97
 substitutions, 98
 trigonometric, 207–209
 term by term, 81
 of vector functions, 426–431
 zero length interval, 98
- Integration formulas, open and closed, 363–369
- Interpolation methods, 499–500
 Lagrange, 500
 linear, 499
 spline, 500–501
- Inverse Fourier convolution theorem, 355
- Inverse hyperbolic functions
 definitions, 3, 139, 153
 derivatives, 152
 domains of definition, 139
 graphs, 141
 identities, 139, 142–143
 integrals, 9–10, 201–205
 principal values, 139
 relationships between, 143
 series, 10–12, 146
- Inverse Jacobian elliptic function, 250
- Inverse Laplace convolution theorem, 339
- Inverse Laplace transform, 66
- Inverse, of matrix, 56
- Inverse trigonometric functions
 derivatives, 150–151
 differentiation, 4, 128, 140
 domains of definition, 139
 functional relationships, 139
 graphs, 140–141
- identities, 128, 131–132
 integrals, 8, 225–229
 principal values, 139
 relationships between, 142–144
 series, 10–12, 134–135
- Inversion integral
 Fourier transform, 354
 Laplace transform, 338
 z -transform, 494
- Irrational algebraic function, *see* Nonrational algebraic function
- Irreducible matrix, 59
- Irregular point, of differential equation, 398
- J**
- Jacobian determinant, 56, 433–434
- Jacobian elliptic function, 247
- Jacobi polynomials, 332–334
 asymptotic formula for, 335
 graphs of, 335
- Jacobi's theorem, 53–54
- Jensen inequality, 31–32
- Joukowski transformation, 523
- K**
- KdV equation, *see* Korteweg-de Vries equation
- KdVB equation, *see* Korteweg-de Vries–Burger's equation
- Korteweg-de Vries–Burger's equation, 469
- Korteweg-de Vries equation, 467–468
- Kronecker delta, 52
- L**
- Lagrange form, of Taylor series remainder term, 87
- Lagrange's identity, 29
- Laguerre polynomials, 325–328
 associated, *see* Generalized Laguerre polynomials
 integrals involving, 327
- Lagrange trigonometric identities, 130
- Laplace convolution, 339
- Laplace convolution theorem, inverse, 339
- Laplace expansion, 51
- Laplace transform
 basic properties, 338
 convolution operation, 339
 definition, 337
 delta function, 340
 for solving initial value problems, 340–341
 initial value theorem, 339
 inverse, 66
 inversion integral, 338
 of Heaviside step function, 338
 pairs, 337, 340–352
 pairs, table, 340–352
 z -transform and, 497
- Laplace's equation, 448, 510, 512
- Laplacian
 partial differential equations, 383–384
 vectors, 429, 435
- Leading diagonal, 58
- Legendre functions, 313–314
 associated, 316–317
- Legendre normal form, of elliptic integrals, 241–242
- Legendre polynomials, 313, 456
 definite integrals involving, 315
- Legendre's equation, 394
- Leibnitz's formula, 96
- Length of arc by integration, 106
- L'Hôpital's rule, 96
- Limit comparison test, 73
- Limiting values
 exponential function, 147
 Fresnel integrals, 262
 logarithmic function, 147
 trigonometric functions, 148
- Line integral, 427–428
- Linear constant coefficient differential equation, 377
- Linear dependence, 371–373
- Linear inhomogeneous equation, 385
- Linear interpolation, 499
- Linear second-order partial differential equation, 448

- Linear superposition property, 448
- Logarithm to base e , 122
- Logarithmic function
 base of, 3
 basic results, 121–122
 definitions, 123
 derivatives, 3, 149–151
 identities, 132
 inequalities involving, 147
 integrals, 4, 8, 181–187
 definite, 256
 limiting values, 147
 series, 12, 76, 137
- Lower limit, for definite integral, 97
- Lower triangular matrix, 59
- M**
- Maclaurin series
 Bernoulli numbers, 40
 definition, 86
- Mass of lamina, 108
- Mathematical induction, 38–40
- Matrix, 58–67
 adjoint, 59
 Cayley–Hamilton theory, 61
 characteristic equation, 60, 61
 definitions, 58–61
 derivatives, 64–65
 diagonal dominance, 55, 60
 diagonalization of, 62
 differentiation and integration, 64–65
 eigenvalue, 60
 eigenvector, 60
 equality, 60
 equivalent, 59
 exponential, 65
 Hermitian, 54
 Hermitian transpose, 59
 idempotent, 60
 identity, 58
 inverse, 59
 irreducible, 59
 leading diagonal, 58
 lower-triangular form, 59
 multiplication, 57–58
 nilpotent, 60
 nonnegative definite, 60
 nonsingular, 55, 59
 normal, 60
 null, 58
 orthogonal, 61
 positive definite, 60
 product, 58–60
 quadratic forms, 62–63
 reducible, 59
 scalar multiplication, 57
 singular, 59
 skew-symmetric, 59
 square, 58
 subtraction, 95
 sums of powers of integers, 36
 symmetric, 59
 transpose, 59
 Hermitian, 59
 unitary, 60
- Matrix exponential, 65
 computation of, 66
- Maximum/minimum principle
 for Laplace equation, 473
- Maxwell's equations, 456–457
- Mean
 of binomial distribution, 254
 of normal distribution, 253
 of Poisson distribution, 255
- Mean-value theorem
 for derivatives, 96
 for integrals, 99
- Midpoint rule, for numerical integration, 364
- Minkowski's inequality, 29–30
- Minor, of determinant element, 51–53
- Mixed type, partial differential equation, 450
- Modified Bessel functions, 294–299
- Modified Bessel's equation, 294–296
- Modified Euler's method, for differential equations, 404–405
- Modular angle, 242
- Modulus
 complex number, 28, 109
 elliptic integral, 241
- Modulus-argument
 representation, 109–110
- Moment of inertia, 107
- Multinomial coefficient, 68
- Multiple angles/arguments
 hyperbolic identities, 135–136
 trigonometric identities, 124
- Multiplicative inverse, of matrix, 59
- Multiplicity, 113, 378
- N**
- Naperian logarithm, 122
- Natural logarithm, 122
- Negative, of vector, 417
- Nested multiplication, in polynomials, 119
- Neumann condition, 511
 for partial differential equations, 449, 450
- Neumann function, 290
- Neumann problem, 450
- Newton's algorithm, 118
- Newton–Cotes formulas, 365–366
- Newton–Raphson method, for determining roots, 117–120
- Newton's method, for determining roots, 117–120
- Nilpotent matrix, 60
- Noncommutativity, of vector product, 421–422
- Nonhomogeneous differential equation, *see*
 Inhomogeneous differential equation
- Nonnegative definite matrix, 60
- Nonrational algebraic functions, integrals, 166–174
- Nonsingular matrix, 55, 59
- Nontrivial solution, 452
- Norm, of orthogonal polynomials, 309
- Normal probability distribution, 240
 definition, 253
 relationship with error function, 253
- Normalized polynomial, 309
- n 'th repeated integral, 258–259
- n 'th roots of unity, 111
- Null matrix, 58
- Null vector, 415
- Numerical approximation, 499–507

- Numerical integration
 (quadrature)
 composite mid-point rule, 364
 composite Simpson's rule, 364
 composite trapezoidal rule, 364
 definition, 463
 Gaussian, 366–367
 Newton–Cotes, 365–366
 open and closed formulas,
 363–364
 Romberg, 367–369
- Numerical methods
 approximation in, 499–507
 for differential equations,
 404–413
- Numerical solution of
 differential equations
 Euler's method, 404
 modified Euler's method,
 404–405
 Runge–Kutta–Fehlberg
 method, 407–410
 Runge–Kutta method, 406,
 407
 two-point boundary value
 problem, 410–413
- O**
- Oblate spheroidal coordinates,
 444–445
- Oblique prism, 17
- Odd function
 definition, 124–125
 Jacobian elliptic, 247
 trigonometric, 125
- Open-type integration formula,
 364–367
- Order
 of determinant, 50
 of differential equations, 447
- Order notation, 77
- Ordinary differential equations
 approximations in, 465–467
 Bernoulli's equation, 374–375
 Bessel's equation, 394–396
 Cauchy–Euler type, 393
 characteristic polynomial, 378
 complementary function, 377
 definitions, 371
 exact, 375
 general solution, 376–377
 homogeneous, 376–382
 hypergeometric, 403–404
 inhomogeneous, 377, 381–382
 initial value problem, 377
 integral method, 400
 Legendre type, 394
 linear, 376–392
 first order, 373–374
 linear dependence and
 independence, 371
 linear homogeneous
 constant coefficient,
 377–381
 second-order, 381–382
 linear inhomogeneous
 constant coefficient, 382
 second-order, 389–390
 particular integrals, 377, 383,
 390–392
 separation of variables, 373
 singular point, 397
 solution methods, 377–413
 Frobenius, 397–402
 Laplace transform, 380
 numerical, 404–413
 variation of parameters,
 383
 two-point boundary value
 problem, 377
- Oriented surface, 430
- Orthogonal coordinates,
 433–445
- Orthogonal matrix, 59
- Orthogonal polynomials
 Chebyshev, 320–325
 definitions, 309–310
 Hermite, 329–332
 Jacobi, 332–335
 Laguerre, 325–329
 Legendre, 310–320
 orthonormal, 309
 Rodrigues' formula, 310, 320,
 325, 329
 weight functions, 309
- Orthogonal trajectories,
 510–511
- Orthogonality relations, 310,
 317, 320–321, 325, 328–329,
 333
- P**
- Pade approximation, 503–505
- Pappus's theorem, 26, 107
- Parabolic cylindrical
 coordinates, 441
- Parabolic equation solutions,
 482–487
- Parabolic partial differential
 equation, 448
- Paraboloidal coordinates, 442
- Parallelepiped, 14
- Parallelogram geometry, 13
- Parameter of elliptic integral,
 242
- Parseval formula, 495
- Parseval relations, 275, 354,
 359
- Parseval's identity, 93
- Partial differential equations
 approximations in, 505–507
 boundary value problem,
 447
 Burger's equation, 467, 470
 Cauchy problem, 449
 characteristic curves, 459
 characteristics, 458–462
 classification, 447–450
 conservation law, 457–458
 definitions, 446–450
 Dirichlet condition, 357, 449
 eigenfunctions, 452
 eigenvalues, 395
 elliptic type, 448
 hyperbolic type, 448
 ill-posed problem, 449
 initial boundary value
 problem, 448
 initial value problem, 448
 KdV equation, 467–470
 KdVB equation, 467–470
 Laplacian, 449
 linear inhomogeneous, 448
 Neumann condition,
 449–450
 parabolic type, 448
 physical applications,
 390–392, 396–402
 Poisson's equation, 449
 Rubin condition, 449, 450
 separation constant, 452
 separation of variables,
 451–453
 shock solutions, 462–464
 similarity solution, 465–467
 soliton solution, 469
 solution methods, 385–402

- Partial differential equations
 (*continued*)
 systems, 456, 458
 Tricomi's equation, 450
 well-posed problem, 450
 Partial fractions, 69–70
 Partial sums, 72
 Fourier series, 92
 Particular integral, and
 ordinary differential
 equations
 definition, 377, 382–383
 undetermined coefficients
 method, 390–392
 Particular solution, of ordinary
 differential equation, 371
 Pascal's triangle, 33–34
 Path, line integral along,
 427–428
 Periodic extension, of Fourier
 series, 285
 Periodic function, 124, 127
 Permutations, 67
 Physical applications
 center of mass, 107
 compressible gas flow, 457
 conservation equation,
 457–458
 heat equation, 465–467
 Maxwell's equations, 456–457
 moments of inertia, 108
 radius of gyration, 108
 Sylvester's law of inertia, 63
 waves, 460, 462–464, 467–470
 Pi
 constant, 3
 series, 75
 Pi function, 231–232
 Plane polar coordinates, 437
 Poisson distribution, mean and
 variance of, 255
 Poisson equation, 449–450
 Poisson integral formula
 for disk, 470
 for half-plane, 470
 Polar coordinates, plane, 437
 Polynomial
 Bernoulli's, 46–47
 characteristic, 378
 Chebyshev, 320–325, 501–503
 definition, 113–114
 Euler, 47–48
 evaluation, 119
 Hermite, 329–332
 interpolation, 499–501
 Laguerre, 325–329
 Legendre, 310–320
 orthogonal, *see* Orthogonal
 polynomials
 roots, 111, 113–120
 Position vector, 424, 434
 Positive definite matrix, 60
 Positive definite quadratic form,
 63
 Positive semidefinite quadratic
 form, 63
 Power
 hyperbolic functions, 137
 integers, 36–37, 44–45
 of series, 83–84
 trigonometric functions,
 124–132
 Power series, 82–86
 Cauchy–Hadamard formula,
 82
 circle of convergence, 82
 definitions, 82–86
 derivative, 83
 error function, 257–259
 integral, 82–83
 normal distribution, 253
 product, 85
 quotient, 83–84
 radius of convergence, 82
 remainder terms, 86
 reversion, 86
 standard, 4
 Power series method, for
 differential equations,
 396–397
 Powers of x
 Hermite polynomial, 331
 integrands involving, 7,
 265–267
 Principle value, of complex
 argument, 110
 Prism geometry, 17
 Probability density function,
 253–254
 Products
 differentiation, 4, 95
 infinite, *see* Infinite product
 matrix, 60–62
 of power series, 85
 types, in vector analysis,
 358–361
 Prolate spheroidal coordinates,
 443–444
 Properly posed partial for a
 differential equation, 449
 Psi (digamma) function, 234
 Pure initial value problem, 449
 Purely imaginary number, 28
 Purely real number, 27
 Pyramid geometry, 15

Q
 Quadratic equation, 112
 Quadratic forms
 basic theorems, 63–64
 inner product, 62
 positive definite, 63
 positive semi-definite, 63
 signature, 63
 Quadratic formula, for
 determining roots, 112
 Quadratic function, 112
 Quadrature formula, 363
 Quasilinear partial differential
 equation, 448
 Quotient
 differentiation, 4, 95
 of power series, 83–84
 of trigonometric functions,
 131

R
 R–K–F method, *see*
 Runge–Kutta–Fehlberg
 method
 Raabe's test, for convergence,
 73
 Radius of convergence, 82
 Radius of gyration, 108
 Raising to a power, 84
 Rankine–Hugoniot jump
 condition, 464
 Rate of change theorem, 431
 Rational algebraic functions
 definitions, 63, 154
 integrals, 154–166
 integration rules, 103–104
 Rayleigh formulas, 306
 Real numbers, inequalities, 28
 Real part, of complex number,
 28–32

- Rectangular Cartesian coordinates, 416, 436
- Rectangular parallelepiped geometry, 14
- Rectangular wedge geometry, 16
- Reducible matrix, 59
- Reduction formula, 99
- Reflection formula, for gamma function, 232
- Region of convergence, 79
- Regula falsi method, for determining roots, 115
- Regular point, of differential equation, 398
- Remainder
in numerical integration, 363
in Taylor series, 86
- Reverse mapping, 513
- Reversion, of power series, 86
- Reynolds number, 465
- Rhombus geometry, 13
- Riemann function, 471
- Riemann integral formula, 472
- Riemann–Lebesgue lemma, 91
- Right-handed coordinates, 416
- Robin conditions, for partial differential equations, 449, 450
- Robin problem, 450
- Rodrigues' formulas, 310, 320, 325, 328–329
- Romberg integration, 367–369
- Romberg method, 368–369
- Roots of complex numbers, 111–112
- Roots of functions, 113–120
bisection method, 114
false position method, 115–116
multiplicity, 113, 378
Newton's method, 117–120
secant method, 116–117
- Roots of unity, 111
- Rouche form, of Taylor series remainder term, 87
- Routh–Hurwitz conditions, for determinants, 58
- Routh–Hurwitz theorem, 57–58
- Runge–Kutta–Fehlberg method, for differential equations, 407–410
- Runge–Kutta methods, for differential equations, 405–410
- ## S
- Saltus, 90, 98
- Scalar, 415
- Scalar potential, 428
- Scalar product, 60, 420–421
- Scalar triple product, 422
- Scale factor, for orthogonal coordinates, 434
- Scale-similar partial differential equation, 465
- Scaling, of vector, 418
- Schlömilch form, of Taylor series remainder term, 87
- Secant method
of determining roots, 116
of interpolation, 412
- Second fundamental theorem of calculus, 97
- Second order determinant, 50–51
- Sector
circular, 18
spherical, 24
- Sectoral harmonics, 319
- Segment
circular, 18
spherical, 24
- Self-similar partial differential equation, 465
- Self-similar solution, to partial differential equations, 465–467
- Sense, of vector, 415
- Separable variables, 373
- Separation of variables method
ordinary differential equation, 373
partial differential equation, 451–453
- Series
alternating, 74
arithmetic, 36
arithmetic–geometric, 36, 74
asymptotic, 93–95
Bernoulli numbers, 41–45
binomial, 10, 75
convergent, *see* Convergence of series
differentiation of, 81
divergent, 72–73, 93
 e , 76
elliptic integrals, 244–245
error function, 257–259
Euler numbers, 40
exponential, 11, 123
Fourier, *see* Fourier series
Fresnel integrals, 261–262
functional, 79–81
gamma function, 77
geometric, 36, 74–75
hyperbolic, 12, 145
infinite, 74–77
integration of, 81
inverse hyperbolic, 12, 146–147
inverse trigonometric, 11, 146
logarithmic, 11, 76–77, 137–139
Maclaurin, *see* Maclaurin series
normal distribution, 253
pi, 75–76
power, *see* Power series
sums with integer coefficients, 36–38, 44–45
Taylor, 86–89
telescoping, 286
trigonometric, 11, 144–145, 245–247
- Series expansion
Bessel functions, 289–292, 298–299
of Hermite polynomials, 331
Jacobian elliptic functions, 247–249
- Shock wave, 462–464, 467–470
- Shooting method, for differential equations, 410–411
- Signature, of quadratic form, 63
- Signed complementary minor, 54
- Simpson's rules, for numerical integration, 364, 365
- Sine Fourier series, 278, 283
- Sine Fourier transform, 355, 357–358
- Sine integrals, 261–264
- Singular point, of differential equation, 398
- Skew-symmetric matrix, 59

- Solitary wave, 469
- Solitons, 469
- Solution
- nontrivial, 452
 - of ordinary differential equations, 371, 376–413
 - of partial differential equation, 447, 452–472
 - temporal behavior, 451
- Spectral Galerkin method, 332
- Sphere, 23–24
- Spherical Bessel functions, 304–307
- Spherical coordinates, 436–439
- Spherical harmonics, 318
- addition theorem of, 320
 - orthogonality of, 319
- Spherical sector geometry, 24
- Spherical segment geometry, 24
- Spheroidal coordinates, 443–444
- Spline interpolation, 500
- Square integrable function, 93
- Square matrix, 58
- Steady-state form, of partial differential equation, 449
- Stirling formula, 233
- Stoke's theorem, 429
- Strictly convex function, 31
- Sturm–Liouville equation, 454
- Sturm–Liouville problem, 452, 453–456
- Substitution, integration by, 97–98, 207–209
- Subtraction
- matrix, 60
 - vector, 415
- Sum
- binomial coefficients, 34–36
 - differentiation, 4, 95
 - finite, 32–38
 - integration, 4
 - matrices, 60
 - powers of integers, 36–37, 44–45
 - vectors, 417
- Surface area, 428
- Surface harmonics, 319
- Surface integral, 428, 429
- Surface of revolution, area of, 106–108
- Sylvester's law of inertia, 63
- Symmetric matrix, 59
- Symmetry relation, 257
- Synthetic division, 119
- T**
- Tables of values
- Bessel function zeros, 294
 - elliptic integrals, 243–247
 - error function, 257
 - gamma function, 237–240
 - Gaussian quadrature, 366–367
 - normal distribution, 254
- Taylor series
- Cauchy remainder, 87
 - definition, 86
 - error term in, 88
 - integral form of remainder, 87
 - Lagrange remainder, 87
 - Maclaurin series, 87
 - Rouché remainder, 87
 - Schlömilch remainder, 87
- Taylor's theorem, 505
- Telescoping, of series, 286
- Temporal behavior, of solution, 451
- Terminal point, of vector, 416
- Tesseral harmonics, 319
- Tetrahedron geometry, 16–17
- Theorem of Pappus, 26, 106
- Third-order determinant, 51
- Toroidal coordinates, 440
- Torus geometry, 26
- Total variation, 90
- Trace, of matrix, 59
- Transcendental function, 153–154, *see also*
- Exponential function;
 - Hyperbolic functions;
 - Logarithmic functions;
 - Trigonometric functions
- Transpose, of matrix, 59
- Trapezium geometry, 13
- Trapezoidal rule, for numerical integration, 364
- Traveling wave, 460
- Triangle geometry, 12
- Triangle inequality, 28–29
- Triangle rule, for vector addition, 417
- Tricomi equation, 450
- Trigonometric functions
- basic relationships, 125
 - connections with hyperbolic functions, 121
 - de Moivre's theorem, 110–111
 - definitions, 124
 - derivatives, 150
 - differentiation, 310
 - graphs, 126
 - half-angle representations, 130–131
 - identities, 1, 111–112, 117–121
 - inequalities involving, 147–148
 - integrals, 4–5, 7–8, 177–179, 209–223
 - definite, 265–269
 - inverse, *see* Inverse
 - trigonometric functions
 - multiple-angle representations, 128–130
 - powers, 130
 - quotients, 131
 - series, 10–12, 144, 244–247
 - substitution, for simplification of integrals, 207–209
 - sums and differences, 127, 128
- Triple product, of vectors, 422–423
- Two-point boundary value problem, 377, 387–388, 408–413
- U**
- Undetermined coefficients
- ordinary differential equations, 390
 - partial fractions, 69–70
- Uniform convergence, 79–81
- Unit integer function, 494
- Unit matrix, 58
- Unit vector, 415
- Unitary matrix, 60
- Upper limit, for definite integral, 97
- Upper triangular matrix, 59
- V**
- Vandermonde's determinant, 55
- Variance
- of binomial distribution, 254

- of normal distribution, 253
 - of Poisson distribution, 255
- Variation of parameters
(constants), 390
- Vector
- algebra, 417–419
 - components, 419–420
 - definitions, 415–416
 - derivatives, 423–426
 - direction cosines, 416–417
 - divergence theorem, 429
 - Green's theorem, 430
 - identities, 431
 - integral theorems, 428–430
 - integrals, 426–431
 - line integral, 427–428
 - null, 415
 - position, 424, 434
 - rate of change theorem, 431
 - scalar product, 420–421
 - Stoke's theorem, 429
 - subtraction, 417–418
 - sum, 417–418
 - triple product, 422–423
- unit, 415
- vector product, 421–423
- Vector field, 428
- Vector function
- derivatives, 423–426
 - integrals, 426–431
 - rate of change theorem, 431
- Vector operator, in orthogonal coordinates, 435–436
- Vector product, 421–423
- Vector scaling, 418
- Vieta's formula, 79
- Volume
- geometric figures, 12–26
 - of revolution, 105–107
- Volume by integration, 105
- W**
- Wallis's formula, 79
- Waves, 460, 462–464, 467–470
- Weak maximum/minimum principle for heat equation, 473
- Wedge, 16, 21
- Weierstrass's M test, for convergence, 80
- Weight function
- orthogonal polynomials, 309, 320–321, 325–329
- Well-posed partial differential equation, 447
- Wronskian
- determinant, 57, 371–372
 - test, 371–373
- Z**
- z -transform, 493–498
- bilateral, 493, 495–496
 - unilateral, 493, 497–498
- Zero
- of Bessel functions, 294
 - of function, 113
- Zero complex number, 28
- Zonal surface harmonics, 319

