

p polyhedron

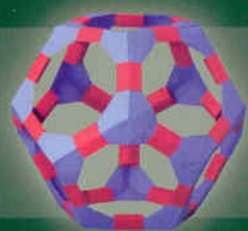

origami
for beginners

miyuki kawamura

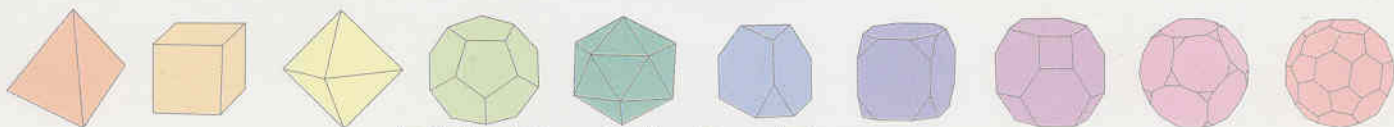

This Book is for Everyone

—those who already love polyhedra,
and those who don't know anything about them.

Do you love polyhedra? Have you made them before?

Or are they a complete mystery to you?

I myself have loved polyhedra since I was a child,
partly because I could see so many different shapes in a single polyhedron.
(But, really, I don't know why I love polyhedra. I just love them, and that's all.)

Before I began to study polyhedra, and to build them with origami,

I didn't know there were so many polyhedra in the world.

There was no one to teach me, and there were no books to show me.

I wanted other people to be able to easily learn about polyhedra,

and to make them themselves,

and so I wrote this book.

I hope this book leads you into the world of polyhedra!

Miyuki Kawamura
(川村みゆき)

Many people helped me write this book. In particular, I owe special thanks
to Tomoko Fuse, Kunihiro Kasahara, Paul Jackson and Thoki Yenn.

For this English edition, thanks also go to Tom Hull
for helping me translate all the technical math terms.

Finally, many, many thanks to Anne LaVin for her translation and editing help,
without which this edition would not have been possible.

© 2001 M. KAWAMURA & NIHON VOGUE CO., LTD.

All right reserved. No part of this publication may be reproduced in any form without written permission of the copyright holders.

Published by NIHON VOGUE CO., LTD.

3-23, Ichigaya Honmura-cho, Shinjuku-ku, Tokyo 162-8705, Japan

Translated by M. KAWAMURA

First Printing: April 2001

Overseas distributor: JAPAN PUBLICATIONS TRADING CO., LTD., Tokyo, Japan

Distributors:

THE UNITED STATES: KODANSHA AMERICA, INC. through OXFORD UNIVERSITY PRESS, 198 Madison Avenue, New York, NY 10016.

CANADA: FITZENRY & WHITESIDE LTD., 195 Allstate Parkway, Markham, Ontario L3R 4T8.

UNITED KINGDOM and EUROPE: PREMIER BOOK MARKETING LTD., Clarendon House, 52 Cornmarket Street, Oxford OX1 3HJ, England

AUSTRALIA and NEW ZEALAND: BOOKWISE INTERNATIONAL PTY LTD., 174 Cormack Road, Wingfield, South Australia 5013, Australia.

ASIA and JAPAN: JAPAN PUBLICATIONS TRADING CO., LTD., 1-2-1 Sarugaku-cho, Chiyoda-ku, Tokyo 101-0064, Japan

ISBN Printed in Japan

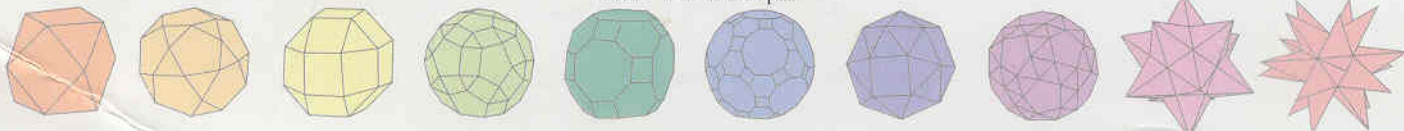

C O N T E N T S

4 ● Folding Symbols, Making a Square

5 ● A Note about Folding and Assembly

6 ● TILES

8 ● BRICKS



12 ● RIGHT CORNERS

16 ● Prism, Antiprism, Pyramid, Dipyrmaid

17 ● PRISMS

20 ● ANTIPRISMS

24 ● PYRAMIDS

27 ● DIPYRAMID

28 ● What is a Polyhedron?

30 ● REGULAR POLYHEDRA

43 ● PAPER BALLOON

44 ● POLYHEDRAL SKELETONS

56 ● POLYHEDRAL FRAMES

60 ● POLYHEDRA KIT

72 ● STARS

86 ● What is a Star Polyhedron?

88 ● FLUTTER WHEELS

91 ● WINDMILL

99 ● What is a Polygon?

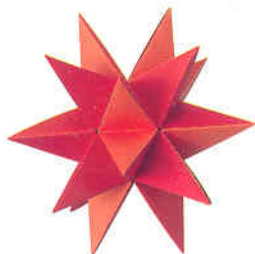
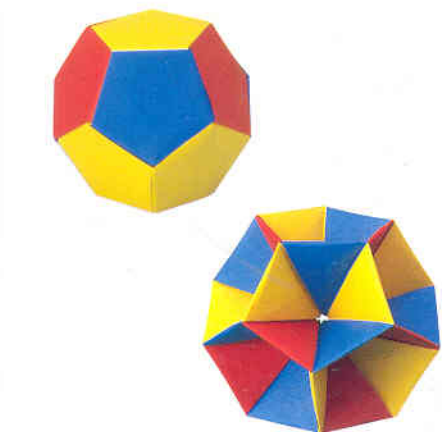
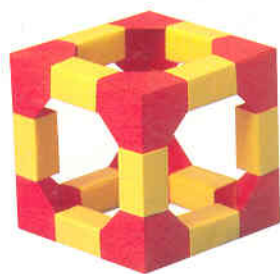

Folding Symbols

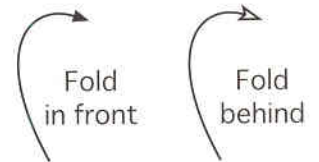
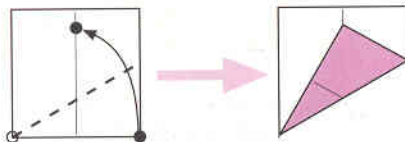
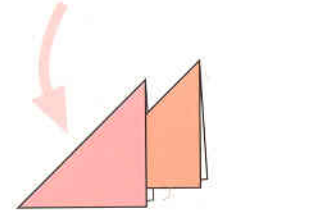
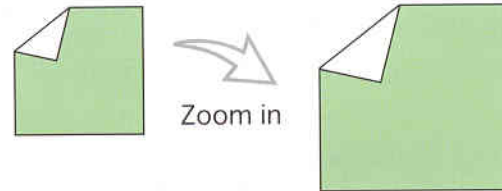
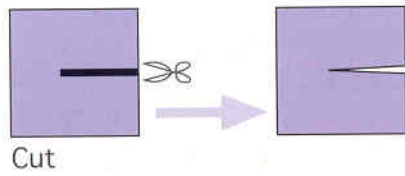
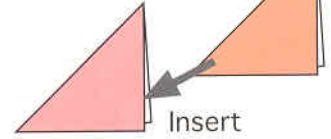
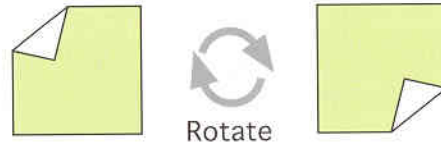
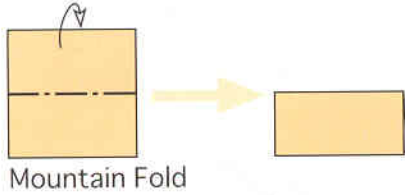
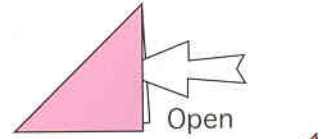
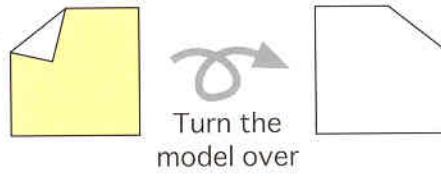
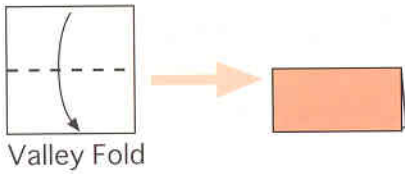

Bring the two points marked ● together and fold. The crese will run to the point marked ○.

How to make a Square Piece of Paper

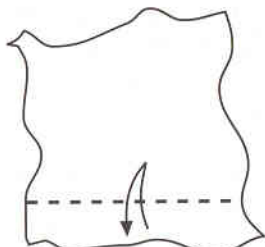

① Fold along a straight line.

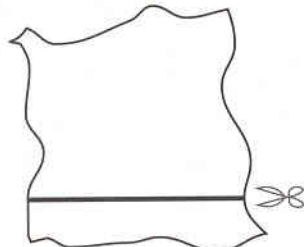

② Cut along the crese.

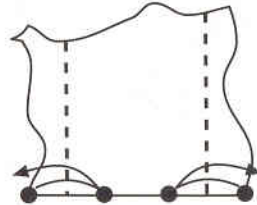

③ Fold by bringing the lower right corner to the bottom edge and unfold. Do the same on the left side.

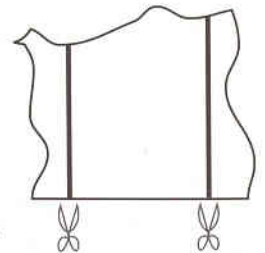

④ Cut along the two crese.

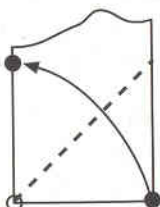

⑤ Bring the bottom edge to the left edge and fold.

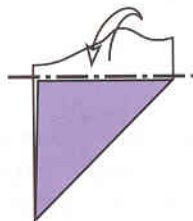

⑥ Fold along the edge and unfold.

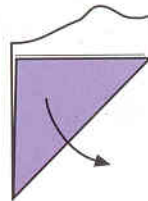

⑦ Unfold

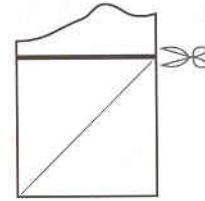

⑧ Cut along the crese.

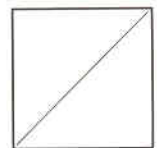

The completed Square Piece of Paper

A Note about Folding and Assembly

- For easy folding, always fold on a flat, firm surface.
- If you cannot understand a diagram, try to look ahead to the next diagram to see what the result is supposed to look like.
- When you fold a piece of paper, you should line up corners, edges and creases very carefully. Neatness is important!
- When you make a crease, always turn the model so you are folding the corner or flap away from you, as in the example to the right. This way you can see the crease while you're folding it.
- Once you've folded a model from one type or color of paper, try folding it again with something different!

- Example: How to fold into a triangle.

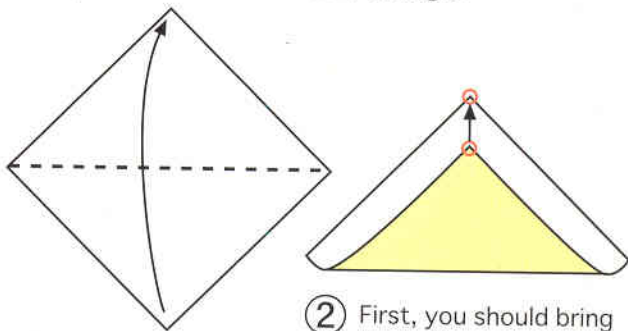

- ① This diagram means fold the paper in half.

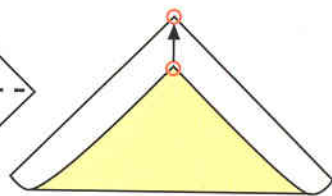

- ② First, you should bring the bottom corner up to the top corner and line them up exactly.

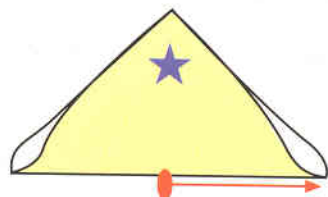

- ③ Second, you hold the part marked ★ with one hand. Then you squash the bottom edge with the other hand from the center to the right corner.

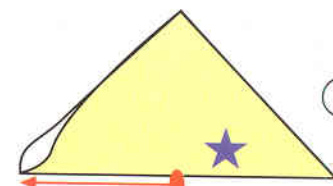

- ④ Do the same on the left side, switching hands.

- Example: A module

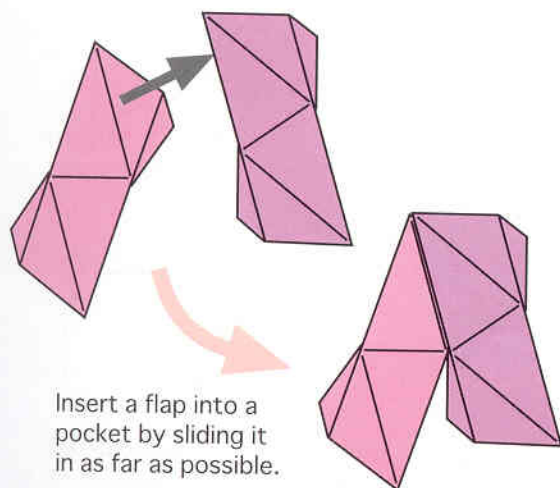
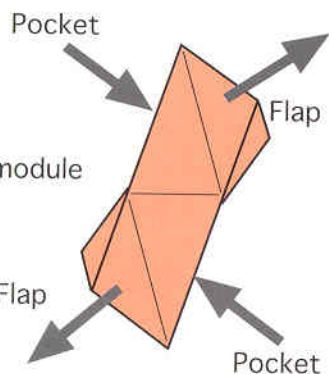

Insert a flap into a pocket by sliding it in as far as possible.

- You will make some geometrical models by putting many modules together. Usually a module has both flaps and pockets. To join, you tuck a flap of a module into a pocket of another module.
- When you assemble modules into a model, you should tuck the flaps into the pockets one by one.
- If you want to strengthen a model, you can put glue on the face of a flap and then insert it into its pocket.
- Tucking the last flap into the last pocket is the most difficult step in the assembly of a model. You should open the model up a little and insert the flap carefully.
- For easy assembly of models with many pieces, start by using 3"~ 5" pieces of square paper. After you have gained some experience, you can try them with different-sized paper.

TILES

SQUARE TILE 1

● Diagram: Page 92



RIGHT TRIANGULAR TILE

● Diagram: Page 93

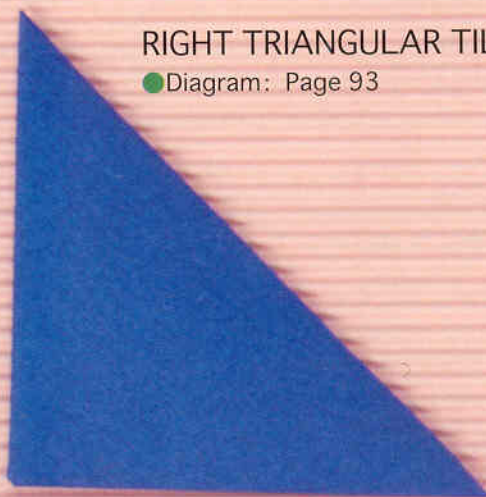

ISOSCELES TRIANGULAR TILE

● Diagram: Page 93

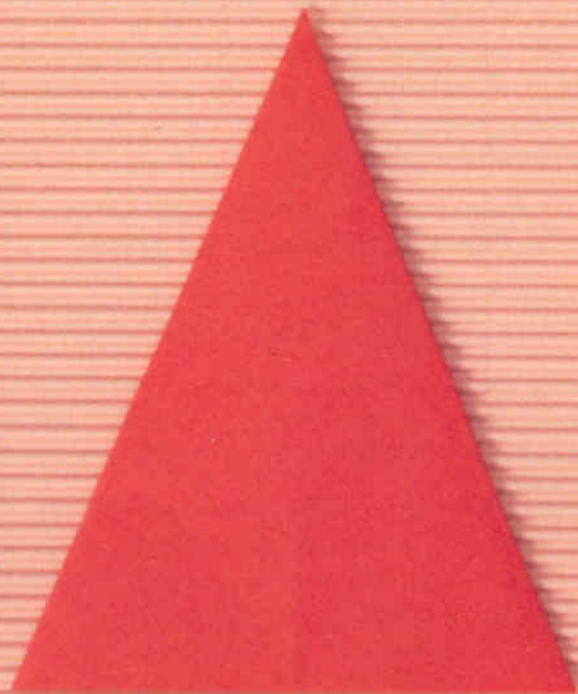

RECTANGULAR TILE 1

● Diagram: Page 92



Front

EQUILATERAL
TRIANGULAR TILE

●Diagram: Page 96



SQUARE TILE 2

●Diagram: Page 94



REGULAR
PENTAGONAL TILE

●Diagram: Page 98



REGULAR
HEXAGONAL TILE

●Diagram: Page 97



RHOMBIC TILE

●Diagram: Page 96



RECTANGULAR TILE 2

●Diagram: Page 94



REGULAR
OCTAGONAL TILE

●Diagram: Page 95

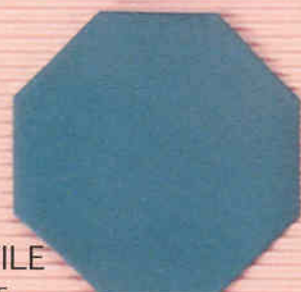

Back

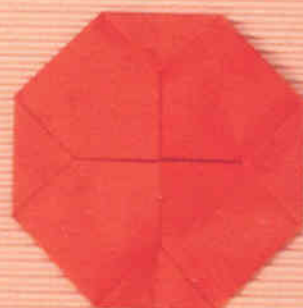

BRICKS

● Diagram: Page 10

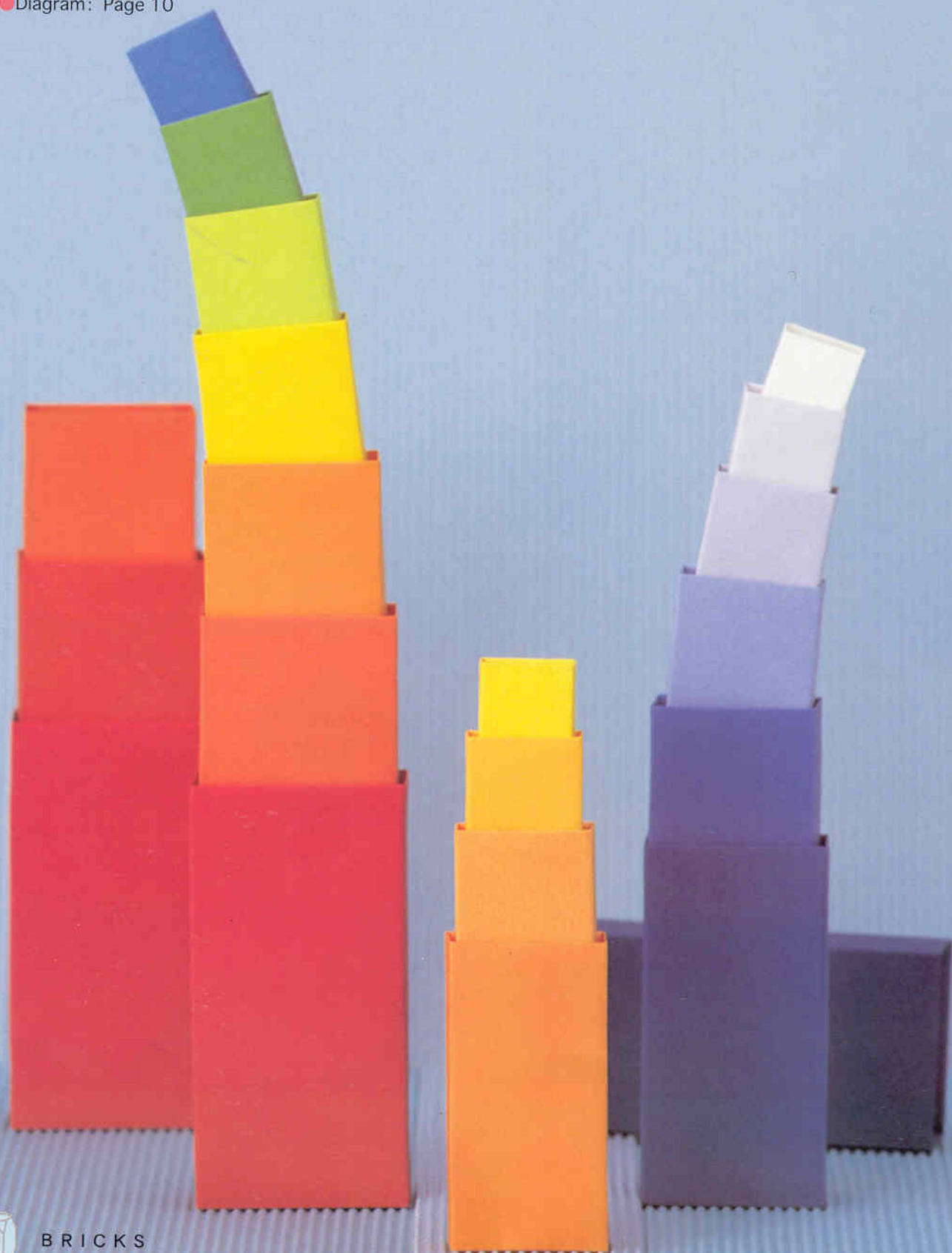



BRICK

れんが
レンガ
RE - N - GA

Start with a square piece of paper.

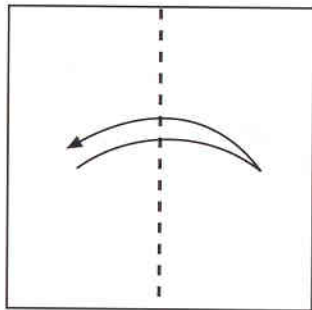

① Fold in half and unfold.

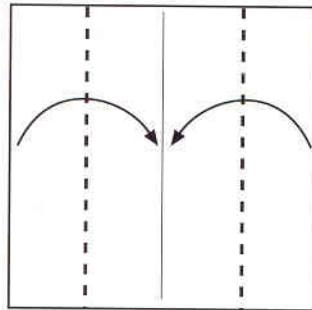

② Bring the right edge to the center line and fold. Do the same on the left side.

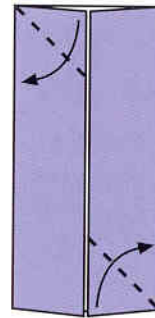

③ Fold only the upper layer.

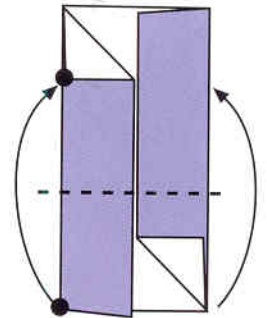

④ Bring the two points marked ● together and fold.

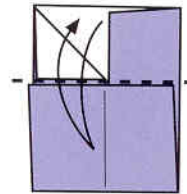

⑤ Fold along the edge and unfold.

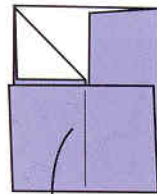

⑥ Unfold.

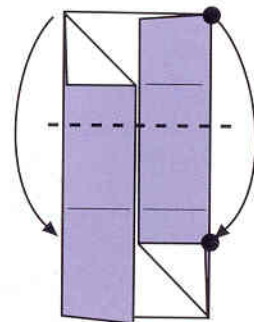
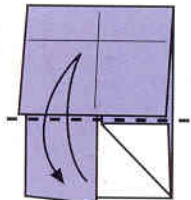

⑦ Bring the two points marked ● together and fold.

⑧ Fold along the edge and unfold.

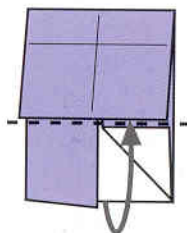

⑨ Tuck the flap into the pocket.

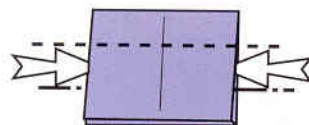

⑩ Open to form a brick. Use existing creases.

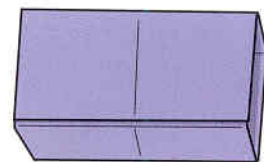

The completed
BRICK

Let's play with lots of BRICKS!

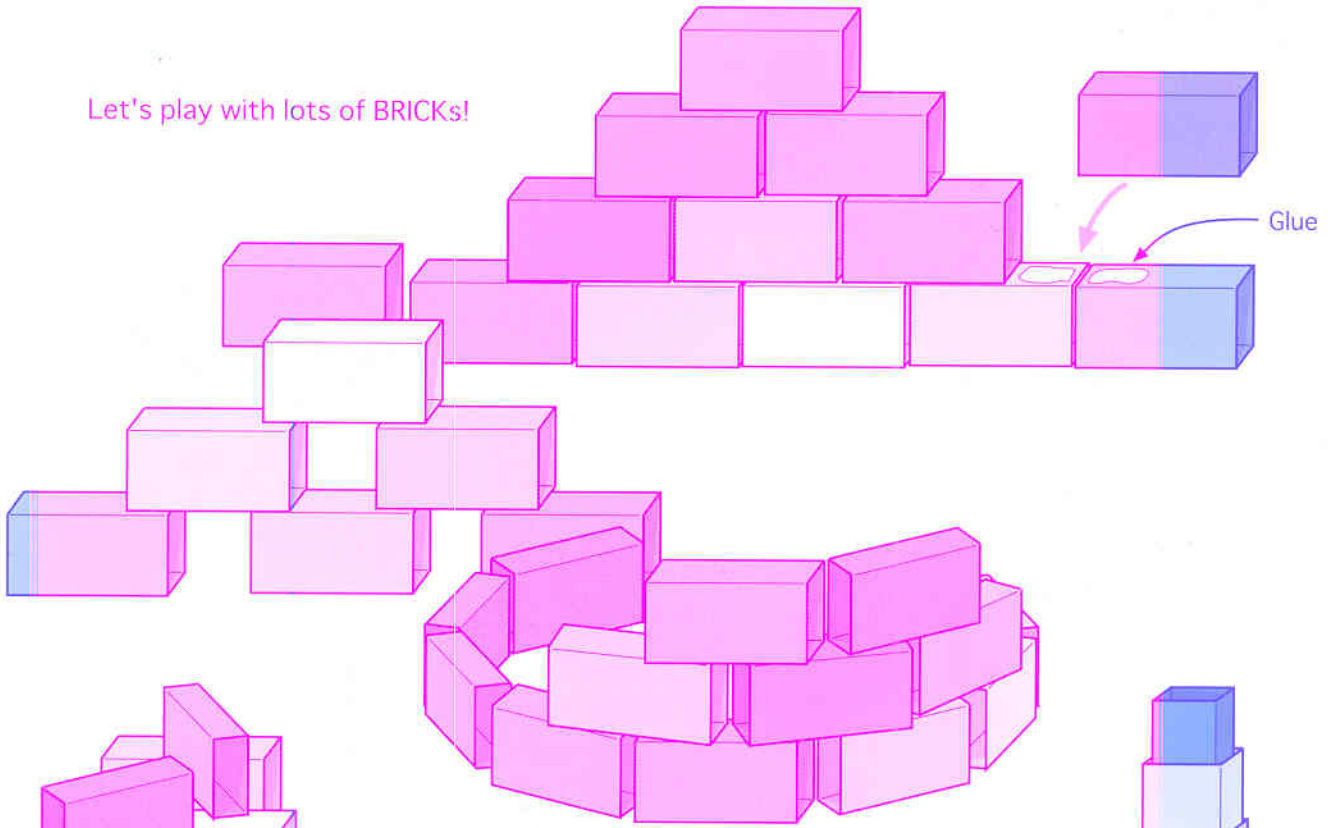

Try making things with various sizes of BRICKS.

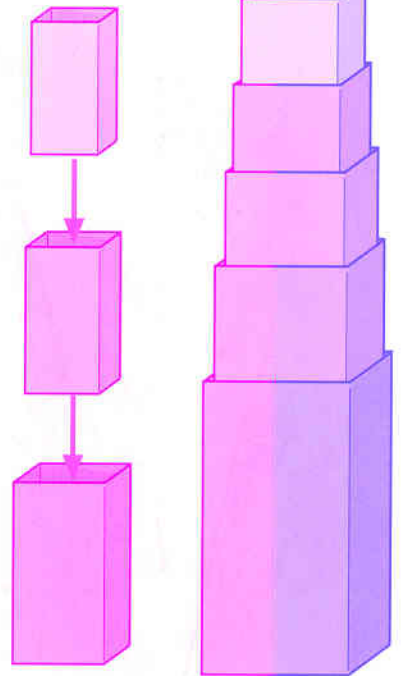
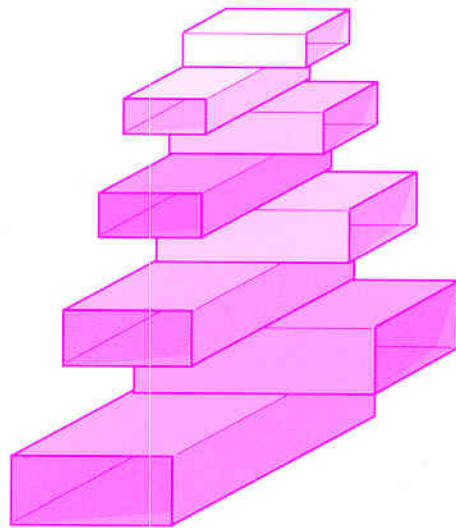
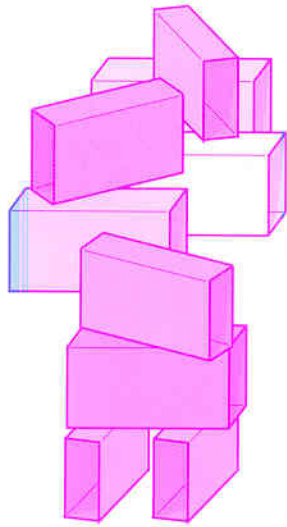

RIGHT CORNERS

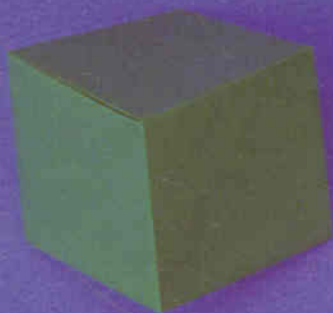

RIGHT CORNER 1

● Diagram: Page 13

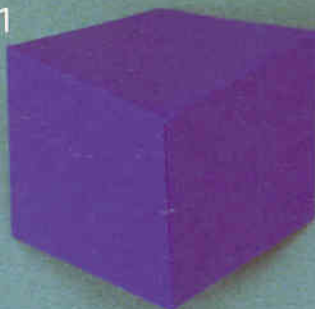

RIGHT CORNER 3

● Diagram: Page 14

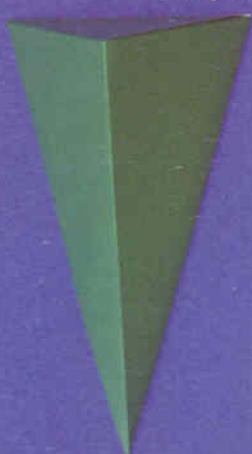

RIGHT CORNER 2

● Diagram: Page 14

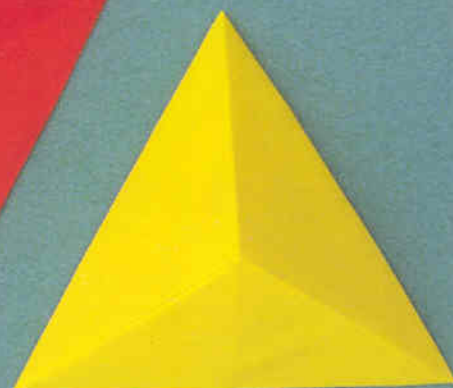

Arrangements of Right Corners



RIGHT CORNER 1

ちよっかくこーなーいち
直角コーナー1
CHOK-KAKU KO-O-NA-A ICHI

Start with a square piece of paper.

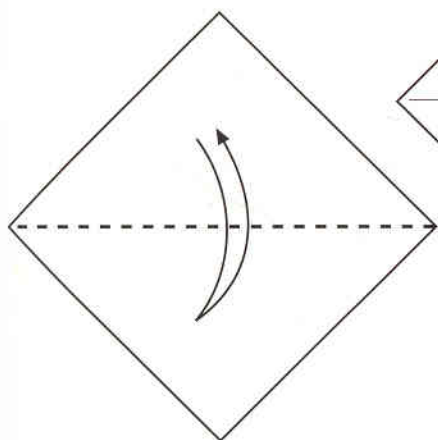

① Fold in half and unfold.

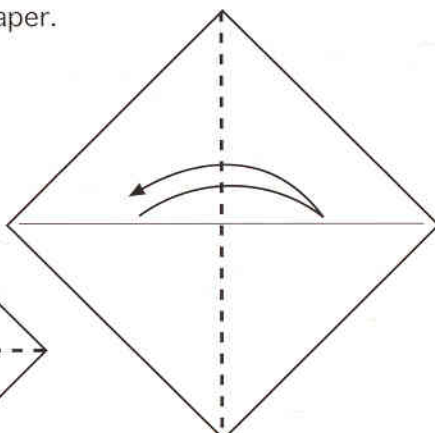

② Fold in half and unfold.

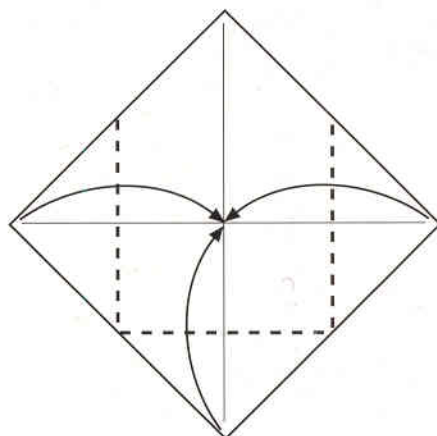

③ Bring the right corner to the center point and fold. Do the same on the left and bottom corners.

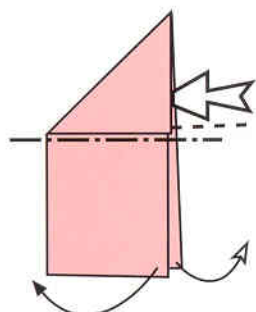

④ Spread the inside open and flatten the top.

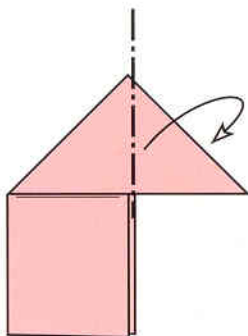

⑤ Tuck the point inside.

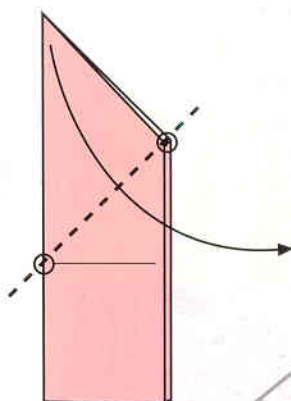

⑥ Fold the top point down along the line connecting the two points marked ○.

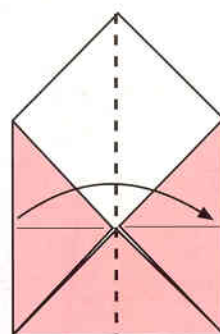

⑦ Fold in half.

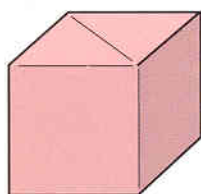

The completed
RIGHT CORNER 1

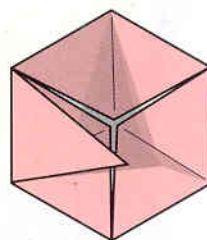
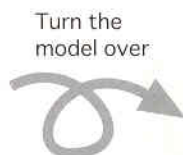

Back view

RIGHT CORNER 2

ちよっかくこーなーに
直角コーナー2
CHOK-KAKU KO - O - NA - A NI

Start with a square piece of paper.

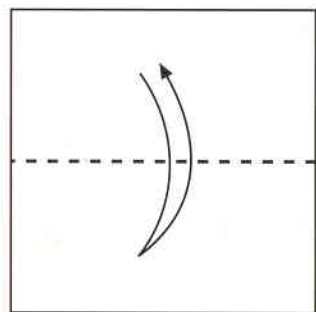

① Fold in half and unfold.

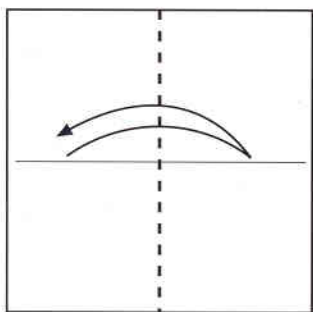

② Fold in half and unfold.

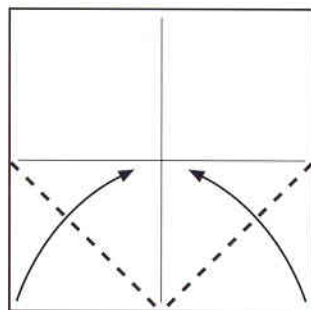

③ Bring the lower right corner to the center point and fold. Do the same on the left side.

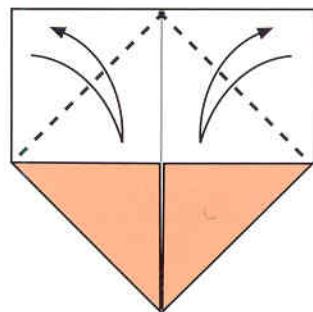

④ Fold by bringing each corner to the center point and unfold.

RIGHT CORNER 3

ちよっかくこーなーさん
直角コーナー3
CHOK-KAKU KO - O - NA - A SAN

Start with a square piece of paper.

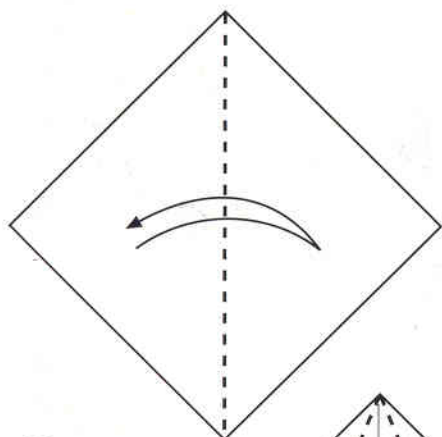

① Fold in half and unfold.

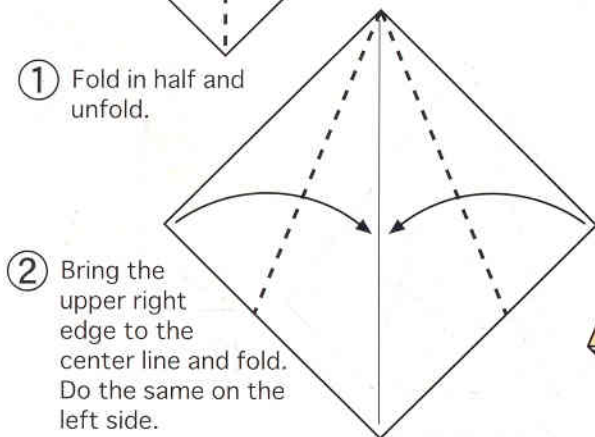

② Bring the upper right edge to the center line and fold. Do the same on the left side.

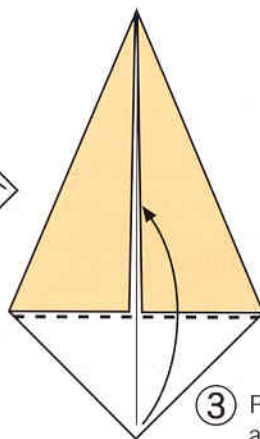

③ Fold the bottom corner up along the edge of the flaps as shown in the diagram.

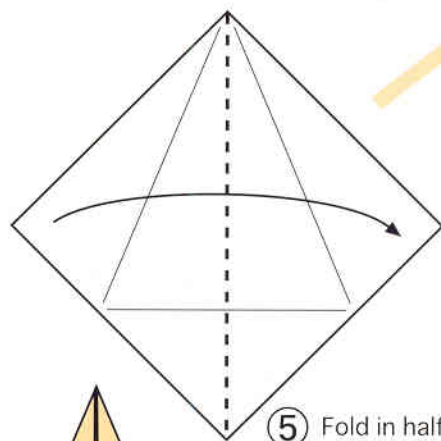

⑤ Fold in half.

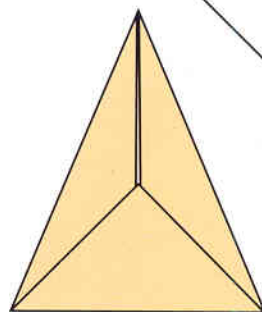

④ Unfold back to a square.



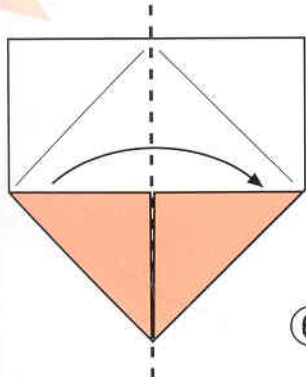

⑤ Fold in half.

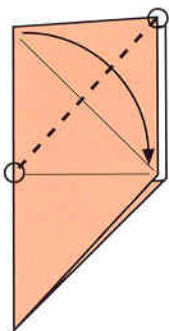

⑥ Fold the top point down along the line connecting the two points marked ○.

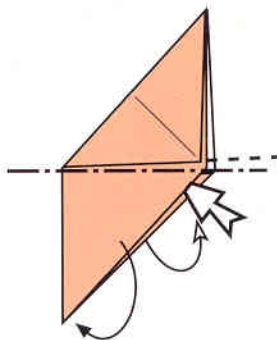

⑦ Spread the inside open and flatten the top.

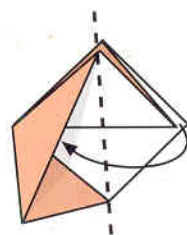

⑧ Fold inside.

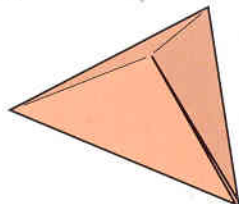

The completed
RIGHT CORNER 2

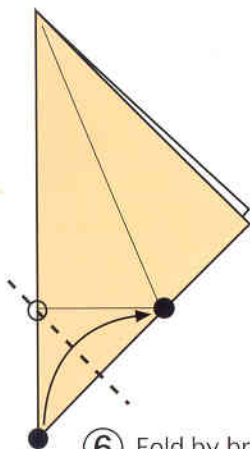

⑥ Fold by bringing the two points marked ● together.

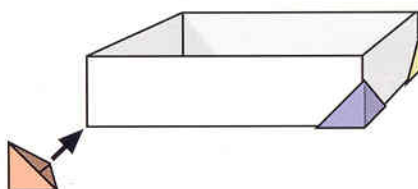

You can glue these on the corners of boxes and BRICKS!

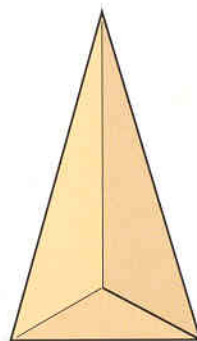
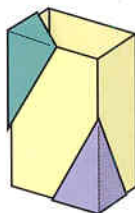
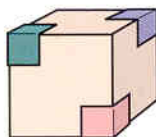

The completed
RIGHT CORNER 3

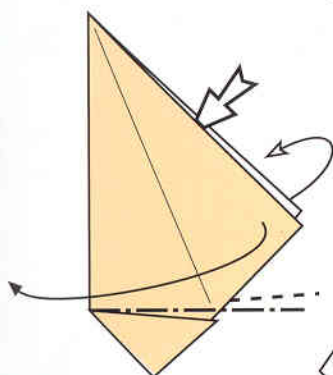

⑦ Spread the inside open and flatten the bottom.

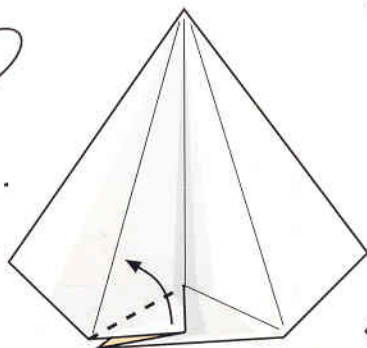

⑧ Fold up the inside flap. (The model is no longer flat.)

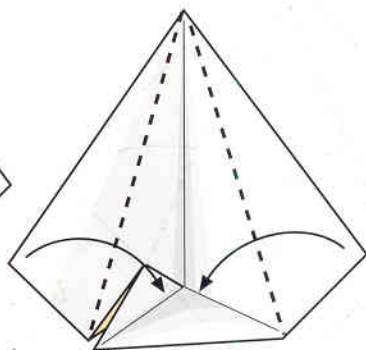

⑨ Fold inside.

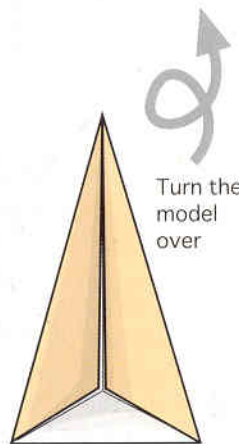

Turn the model over

PRISM

かくちゅう
角柱
KAKU-CHUU

● A prism is a polyhedron whose top and bottom faces are parallel and identical. The other sides are quadrilaterals.

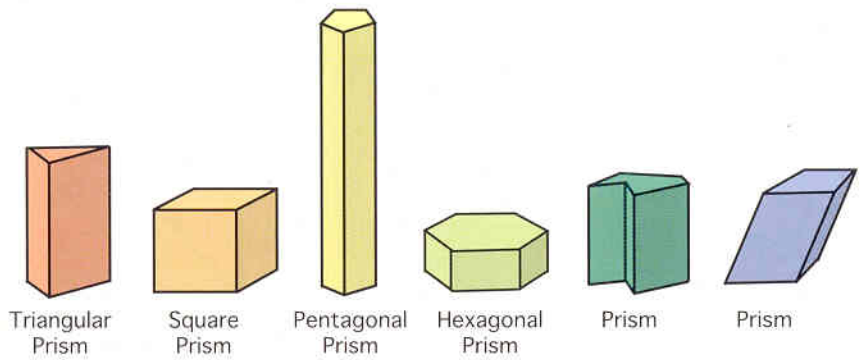

Triangular Prism

Square Prism

Pentagonal Prism

Hexagonal Prism

Prism

Prism

ANTIPRISM

はんかくちゅう
反角柱
HAN-KAKU-CHUU

● An antiprism is a polyhedron whose top and bottom faces are parallel and identical. The other sides are triangles.

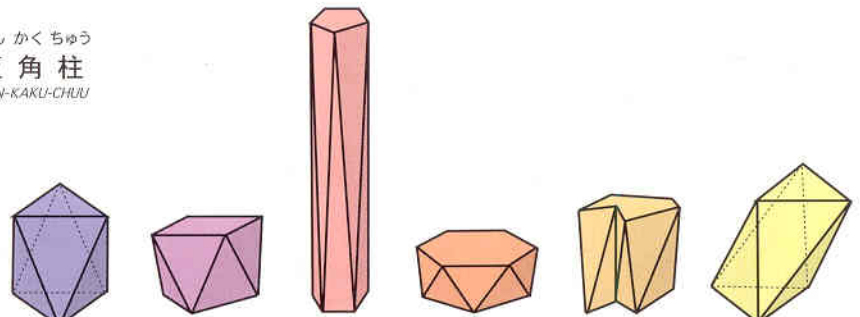

Triangular Antiprism

Square Antiprism

Pentagonal Antiprism

Hexagonal Antiprism

Antiprism

Antiprism

PYRAMID

かくすい
角錐
KAKU-SUI

● A pyramid is a polyhedron with a polygonal bottom face. The other faces are triangles which meet at a point at the top.

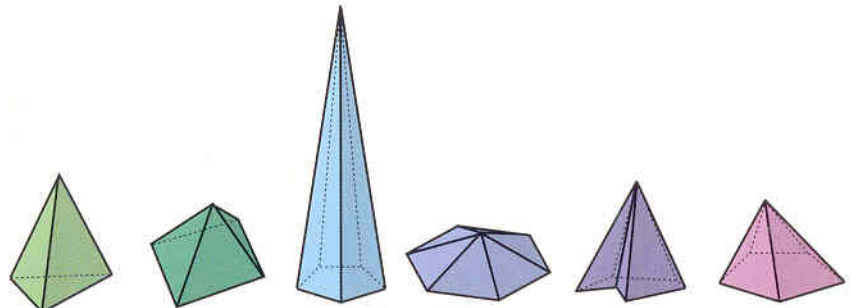

Triangular Pyramid

Square Pyramid

Pentagonal Pyramid

Hexagonal Pyramid

Pyramid

Pyramid

DIPYRAMID

りょうかくすい
両角錐
RYOU-KAKU-SUI

● A dipyramid is made from two pyramids which have been joined at their bases.

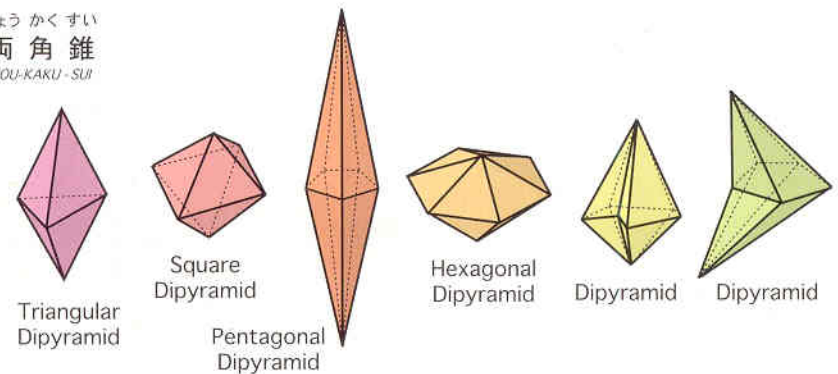

Triangular Dipyramid

Square Dipyramid

Pentagonal Dipyramid

Hexagonal Dipyramid

Dipyramid

Dipyramid

PRISMS

TRIANGULAR PRISM

●Diagram: Page 17



SQUARE PRISM

●Diagram: Page 18



PENTAGONAL PRISM

●Diagram: Page 18



HEXAGONAL PRISM

●Diagram: Page 18



TRIANGULAR PRISM

さんかくちゅう
三角柱
SAN-KAKU-CHUU

Start with a square piece of paper.

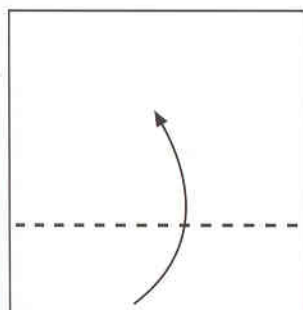

① Fold at about the quarter line.

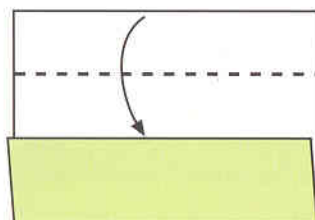

② Bring the top edge down to the other edge of the paper and fold.

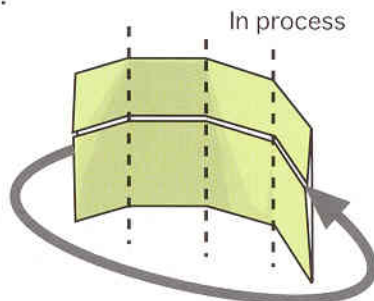

The completed
TRIANGULAR PRISM

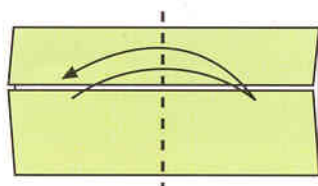

③ Fold in half and unfold.

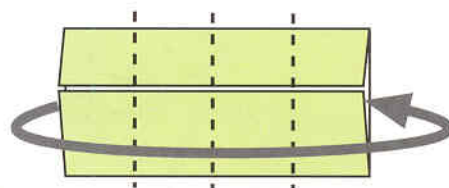

⑥ Tuck one flap inside the other end.

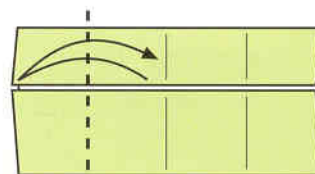

⑤ Fold along the quarter line and unfold.

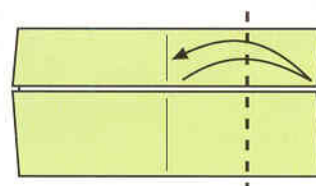

④ Fold along the quarter line and unfold.

SQUARE PRISM

し かく ちゅう
4 角 柱
SHI-KAKU-CHUU

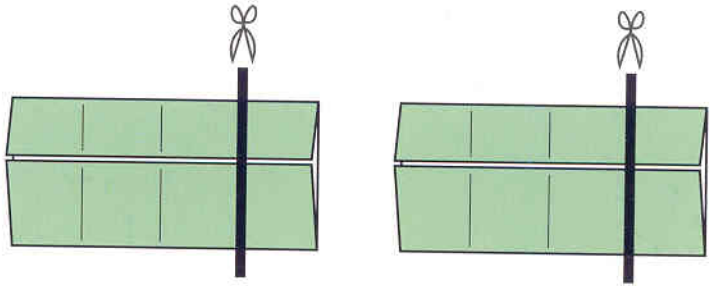
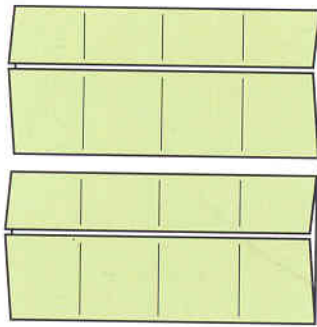

⑦ Cut one flap off each piece.

You will need 2 pieces from step ⑤ on page 17 for each model.

PENTAGONAL PRISM

ご かく ちゅう
5 角 柱
GO-KAKU-CHUU

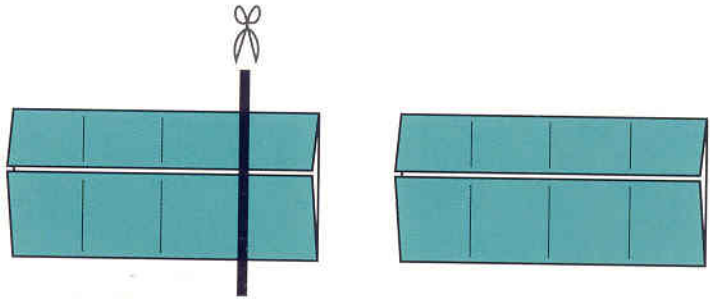
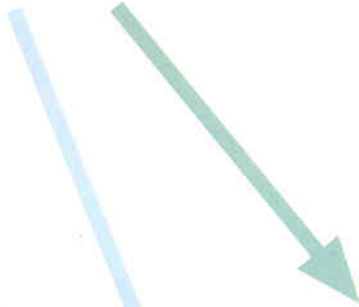

⑦ Cut off only one flap.

HEXAGONAL PRISM

ろっ かく ちゅう
6 角 柱
ROK-KAKU-CHUU

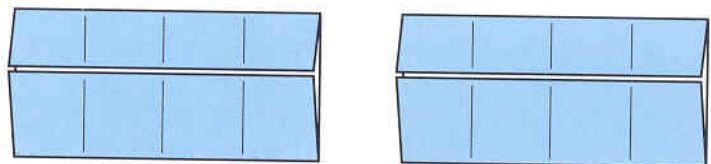

⑦

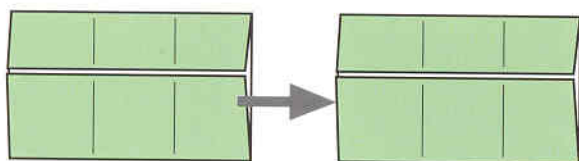

⑧ Insert one flap into the other module.

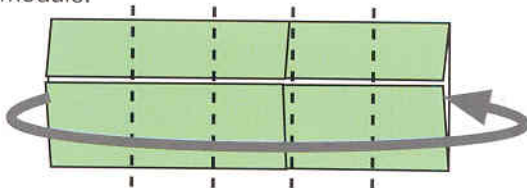

⑨ Tuck one flap inside the other end.

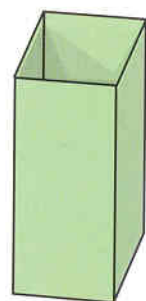

The completed
SQUARE PRISM

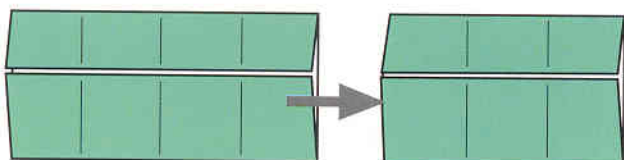

⑧ Insert one flap into the other module.

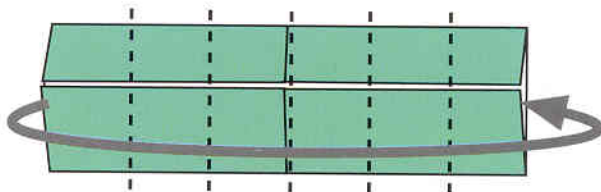

⑨ Tuck one flap inside the other end.

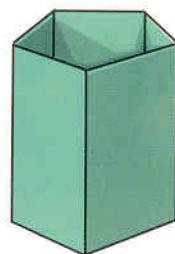

The completed
PENTAGONAL PRISM

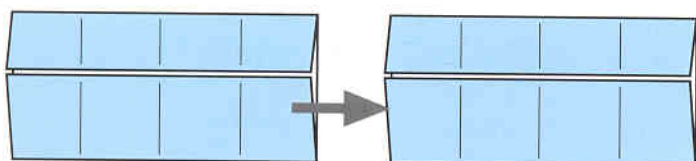

⑧ Insert one flap into the other module.

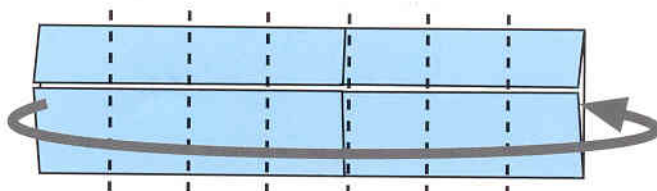

⑨ Tuck one flap inside the other end.

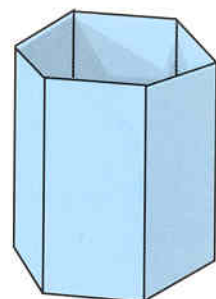

The completed
HEXAGONAL PRISM

ANTIPRISMS



TRIANGULAR
ANTIPRISM

● Diagram: Page 21

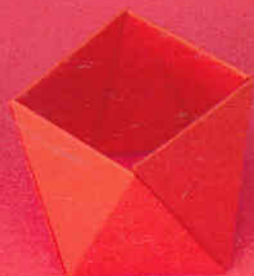

SQUARE
ANTIPRISM

● Diagram: Page 22



PENTAGONAL
ANTIPRISM

● Diagram: Page 22

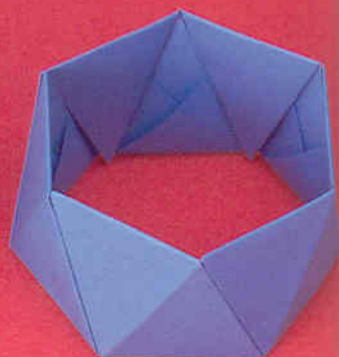

HEXAGONAL
ANTIPRISM

● Diagram: Page 22

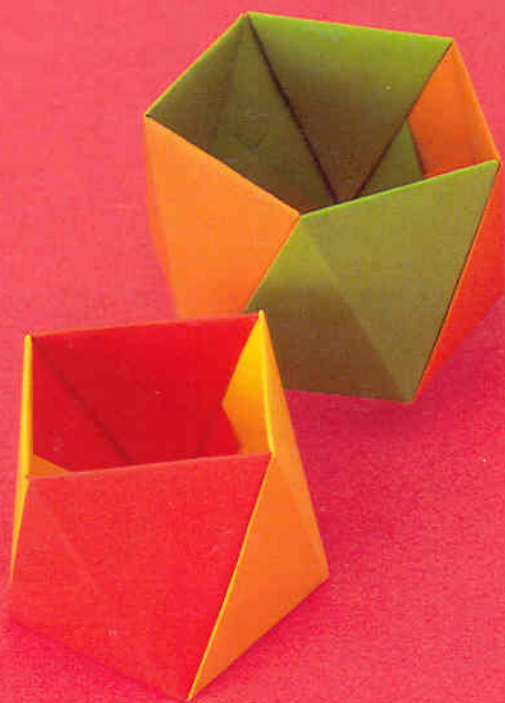

TRIANGULAR ANTIPRISM

はんさんかくちゅう
反三角柱
HAN-SAN-KARU-CHUU

You need 3 square pieces of paper, all the same size.

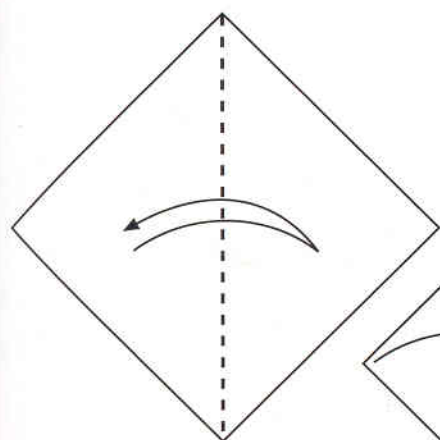

① Fold in half and unfold.

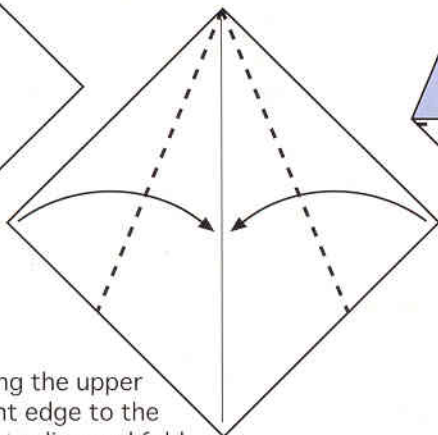

② Bring the upper right edge to the center line and fold. Do the same on the left side.

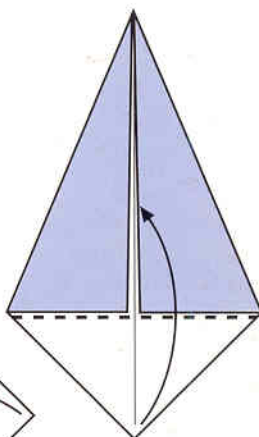

③ Fold the bottom corner up along the edge of the flaps as shown.

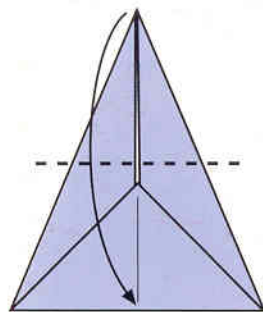

④ Bring the top point to the center of the bottom edge and fold.

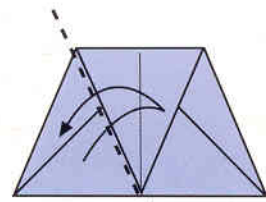

⑤ Fold along the edge and unfold.

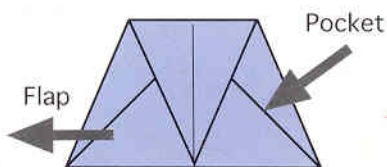

⑦ This is the Antiprism Module. You need 3 modules.

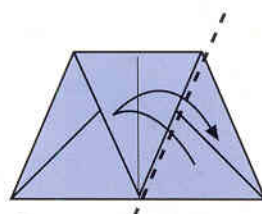

⑥ Fold along the edge and unfold.

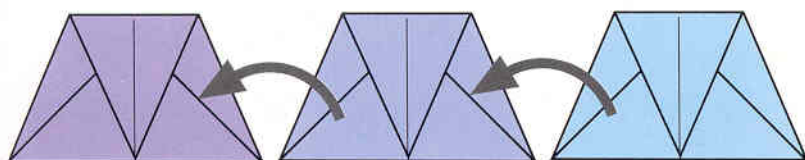

⑧ Insert a flap into the pocket of another module. Do the same once more.

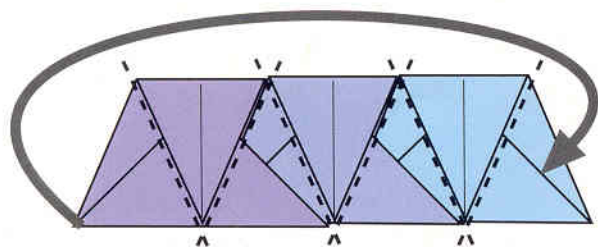

⑨ Tuck the flap into the pocket.

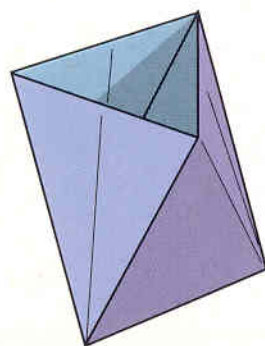

The completed
TRIANGULAR ANTIPRISM

SQUARE ANTIPRISM

はん し かくちゆう
反 4 角 柱
HAN - SHI - KAKU-CHUU

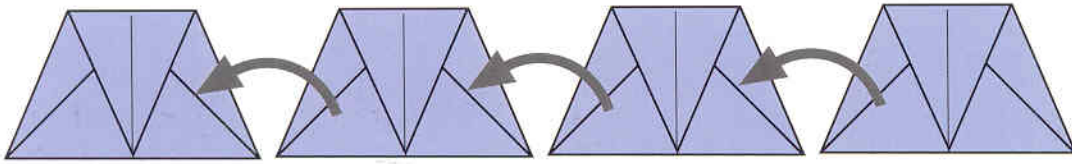

You need 4 Antiprism Modules from page 21.
Insert a flap into the pocket of another module and do the same two more times. Then tuck the flap into the pocket at the other end.

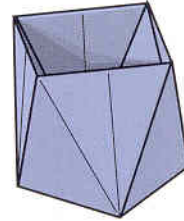

The completed
SQUARE
ANTIPRISM

PENTAGONAL ANTIPRISM

はん ご かくちゆう
反 5 角 柱
HAN - GO - KAKU-CHUU

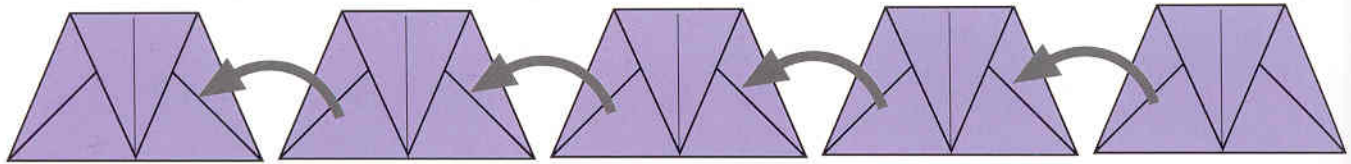

You need 5 Antiprism Modules from page 21.
Insert a flap into the pocket of another module and do the same three more times. Then tuck the flap into the pocket at the other end.

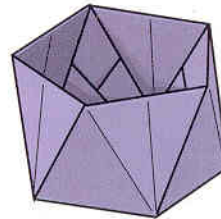

The completed
PENTAGONAL
ANTIPRISM

HEXAGONAL ANTIPRISM

はん ろく かくちゆう
反 6 角 柱
HAN - ROK - KAKU-CHUU

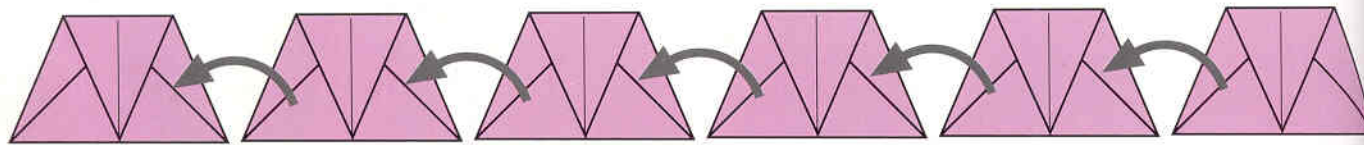

You need 6 Antiprism Modules from page 21.
Insert a flap into the pocket of another module and do the same four more times. Then tuck the flap into the pocket at the other end.

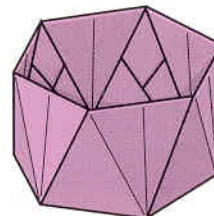

The completed
HEXAGONAL
ANTIPRISM

Arrangements of Antiprisms

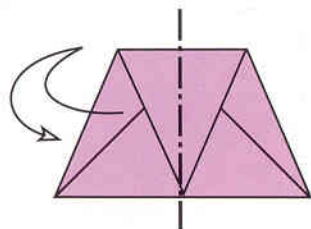

- ① (This is the Antiprism Module from page 21. You need 3 modules.) Fold along the center line and unfold. Do the same to the other two modules.

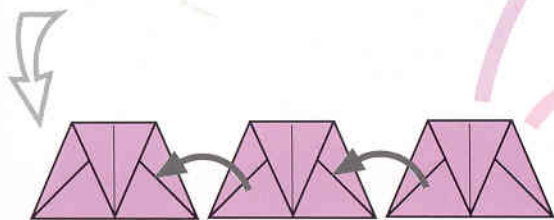

- ② Insert a flap into the pocket of another module and do the same. Then tuck the flap into the pocket at the other end. You can make two types of models.

Type 1

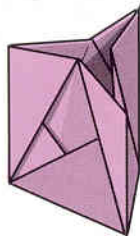

3 modules

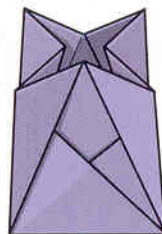

4 modules

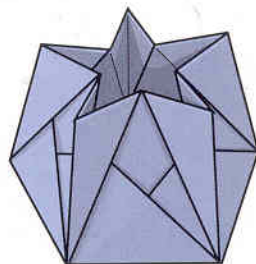

5 modules

Type 2



3 modules

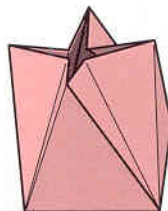

4 modules

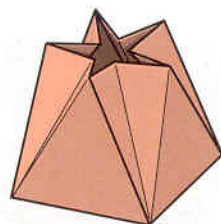

5 modules

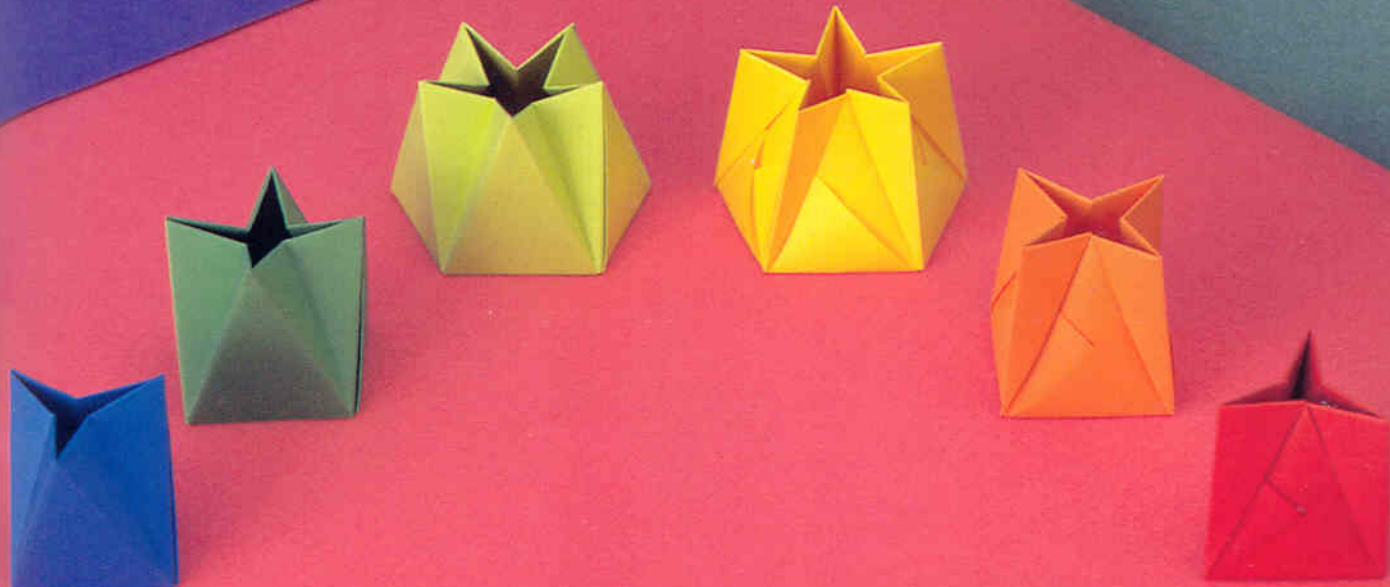

PYRAMIDS



TRIANGULAR
PYRAMID

● Diagram: Page 25



SQUARE
PYRAMID

● Diagram: Page 26



PENTAGONAL
PYRAMID

● Diagram: Page 26

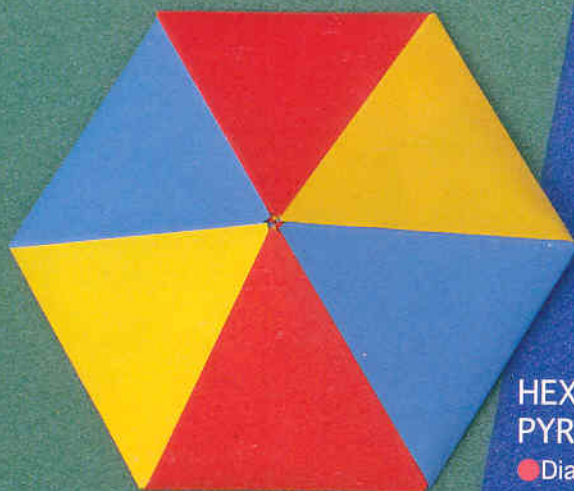

HEXAGONAL
PYRAMID

● Diagram: Page 26

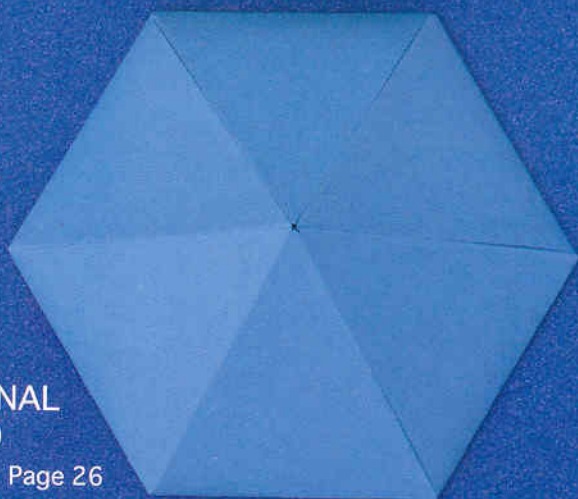

TRIANGULAR PYRAMID

さん かく すい
3 角 錐
SAN-KAKU-SUI

You need 3 square pieces of paper, all the same size.

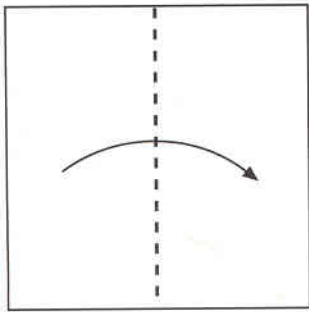

① Fold in half.

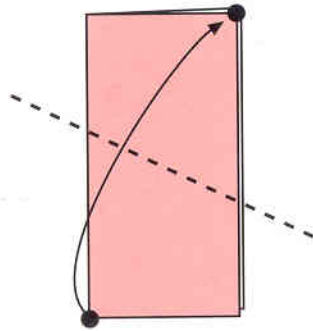

② Fold by bringing the two points together.

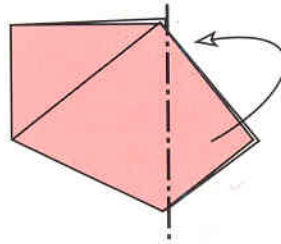

③ Tuck the two flaps inside.

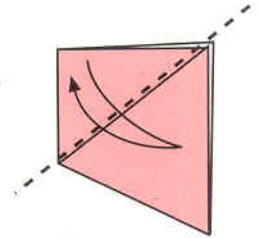

④ Fold and unfold.

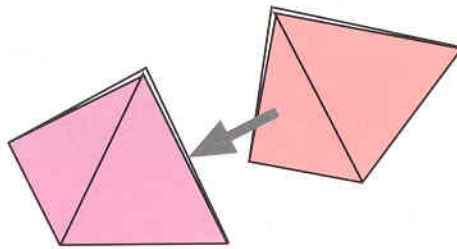

⑥ Insert a flap into the pocket of another module.

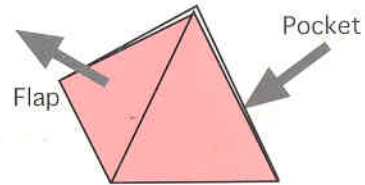

⑤ This is the Pyramid Module. You need 3 modules.

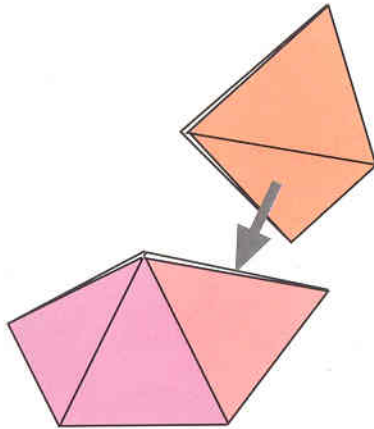

⑦ Do the same once more.

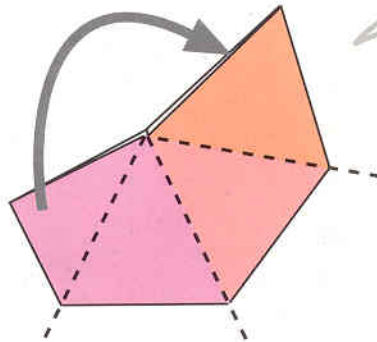

⑧ Tuck the flap into the pocket and make a mountain shape.

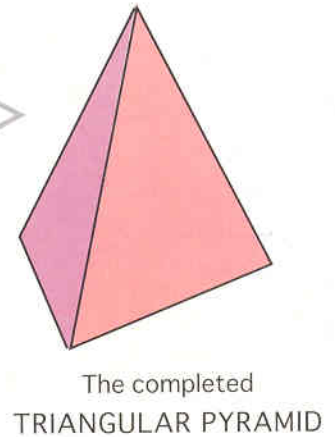

The completed
TRIANGULAR PYRAMID

SQUARE PYRAMID

し かくすい
4 角 錐
SHI - KAKU - SUI

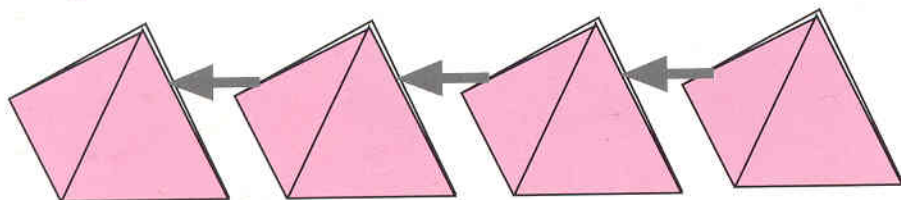

The completed
SQUARE PYRAMID

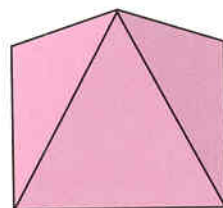

You need 4 Pyramid Modules from page 25.
Insert a flap into the pocket of another module and do the same two more times. Then tuck the flap into the pocket at the other end and make a mountain shape.

PENTAGONAL PYRAMID

ご かくすい
5 角 錐
GO - KAKU - SUI

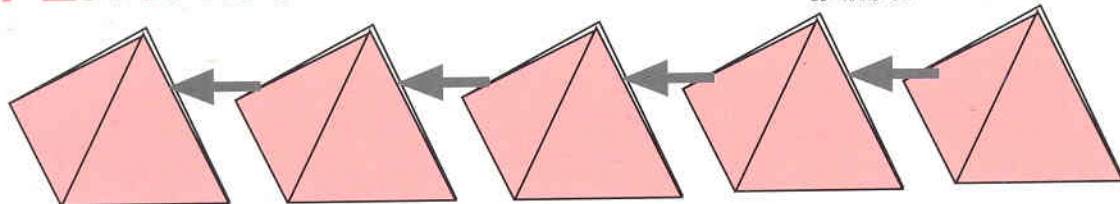

The completed
PENTAGONAL
PYRAMID

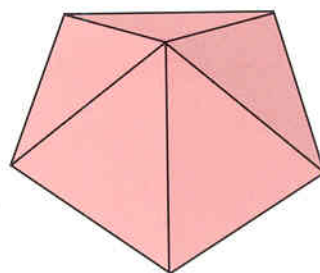

You need 5 Pyramid Modules from page 25.
Insert a flap into the pocket of another module and do the same three more times. Then tuck the flap into the pocket at the other end and make a mountain shape.

HEXAGONAL PYRAMID

ろっ かくすい
6 角 錐
ROK - KAKU - SUI

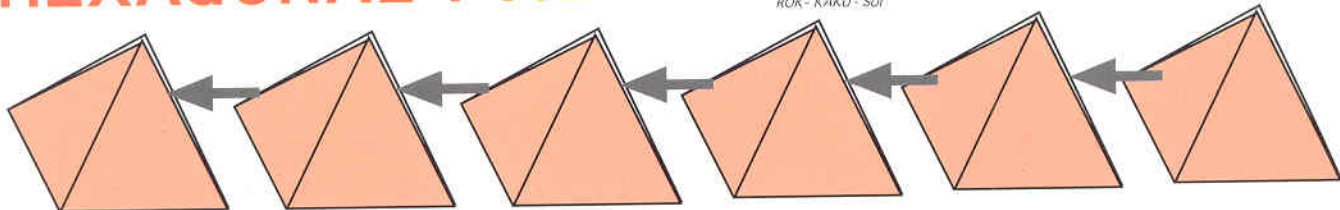

The completed
HEXAGONAL
PYRAMID

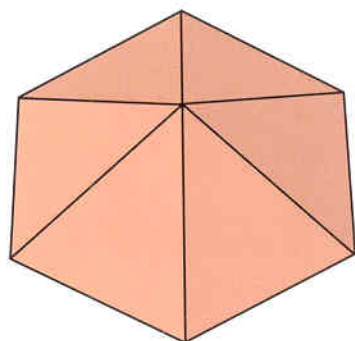

You need 6 Pyramid Modules from page 25.
Insert a flap into the pocket of another module and do the same four more times. Then tuck the flap into the pocket at the other end and make a mountain shape.

DIPYRAMIDS

りょう かく すい
両角錐
RYOU-KAKU-SUI

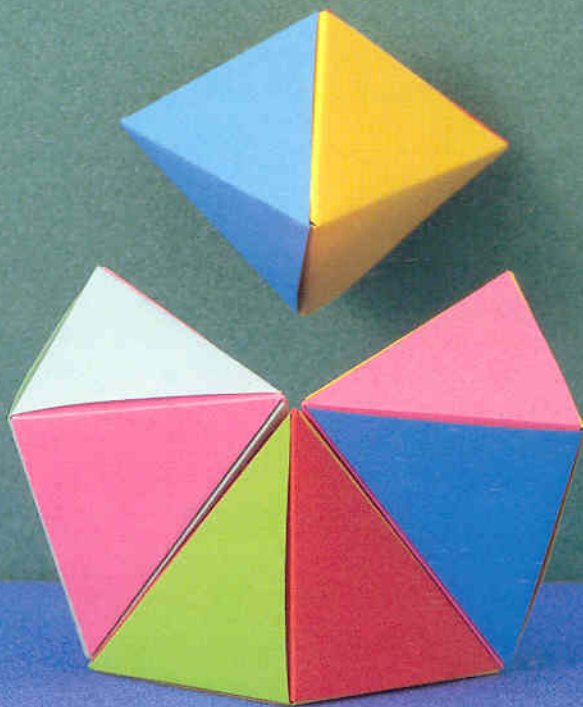

You need 3 square pieces of paper, all the same size.

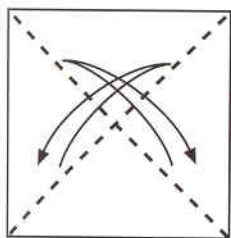

① Fold and unfold.

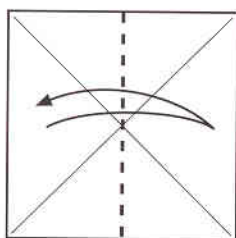

② Fold and unfold.

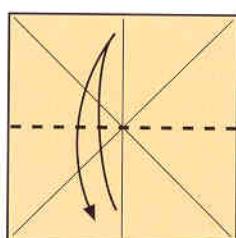

③ Fold and unfold.

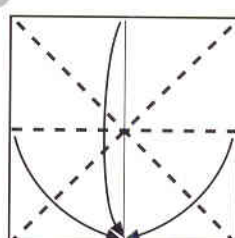

④ Fold by using all the creases at the same time.

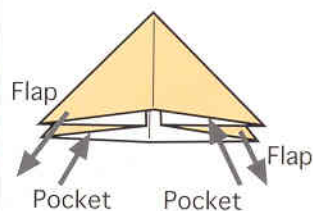

⑤ This is the Dipyramid Module. You need 3 modules.

Turn the model over

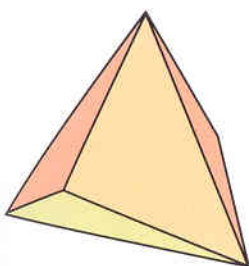

The completed
DIPYRAMID

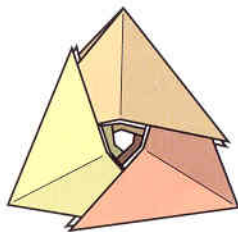

⑧ Pushing gently, bit by bit, bring the pieces together. (The models is no longer flat.)

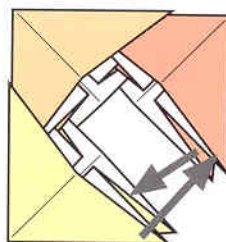

⑦ Push together and insert the last two flaps into the last two pockets.

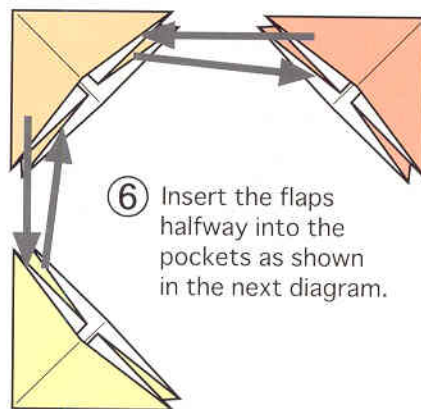

⑥ Insert the flaps halfway into the pockets as shown in the next diagram.

POLYHEDRON

た めん たい
多 面 体
TA - MEN - TAI

- A polyhedron is a 3-D solid with polygonal faces.
- The names of these shapes come from Greek and Latin words. For example, "tetra" means four, "octa" is eight and "dodeca" is twelve.
- Every polyhedron has vertices, edges and faces enclosing a space. The inside of the polyhedron is called the interior, and the outside is the exterior.

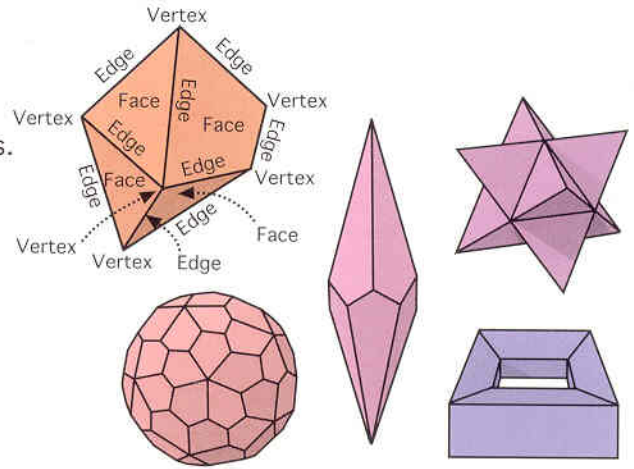

REGULAR POLYHEDRON

せい た めん たい
正 多 面 体
SEI - TA - MEN - TAI

- A regular polyhedron is a polyhedron whose faces are all identical, regular polygons and whose vertices are formed by the same number of faces. (See "Regular Polygon" on page 99.)
- There are nine kinds of regular polyhedra. Four of them are stellated polyhedra. (See "Star Polyhedra" on page 86.)

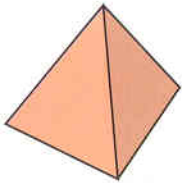

★ Tetrahedron

正 4 面 体 / せい し めん たい
(SEI-SHI-MEN-TAI)

| | | |
|----------------------------------|-------------------------|------------|
| The shape and number of faces | 4 Equilateral Triangles | |
| The number of edges and vertices | 6 Edges | 4 Vertices |

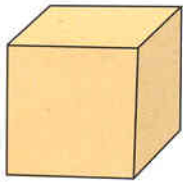

★ Cube

立 方 体 / りっほうたい
(RIP-POU-TAI)

| | |
|-----------|------------|
| 6 Squares | |
| 12 Edges | 8 Vertices |

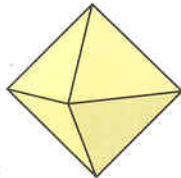

★ Octahedron

正 8 面 体 / せい はちめんたい
(SEI-HACHI-MEN-TAI)

| | |
|-------------------------|------------|
| 8 Equilateral Triangles | |
| 12 Edges | 6 Vertices |

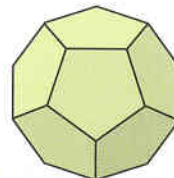

★ Dodecahedron

正 12 面 体 / せいじゅうにめんたい
(SEI-JUUNI-MEN-TAI)

| | |
|----------------------|-------------|
| 12 Regular Pentagons | |
| 30 Edges | 20 Vertices |



★ Icosahedron

正 20 面 体 / せい にじゅうめんたい
(SEI-NIJUU-MEN-TAI)

| | |
|--------------------------|-------------|
| 20 Equilateral Triangles | |
| 30 Edges | 12 Vertices |

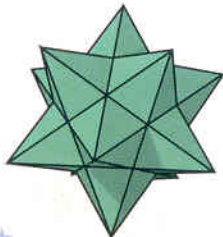

★ Small Stellated Dodecahedron

小 星 形 12 面 体 / しょうほしがたじゅうにめんたい
(SHOU-HOSHI-GATA-JUUNI-MEN-TAI)

| | |
|--------------------------------|-------------|
| 12 Regular Stellated Pentagons | |
| 30 Edges | 20 Vertices |

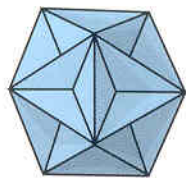

★ Great Dodecahedron

大 12 面 体 / だいじゅうにめんたい
(DAI-JUUNI-MEN-TAI)

| | |
|----------------------|-------------|
| 12 Regular Pentagons | |
| 30 Edges | 20 Vertices |

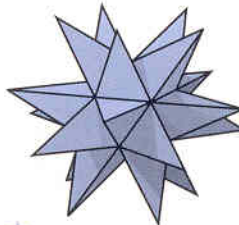

★ Great Stellated Dodecahedron

大 星 形 12 面 体 / だいほしがたじゅうにめんたい
(DAI-HOSHI-GATA-JUUNI-MEN-TAI)

| | |
|--------------------------------|-------------|
| 12 Regular Stellated Pentagons | |
| 30 Edges | 20 Vertices |

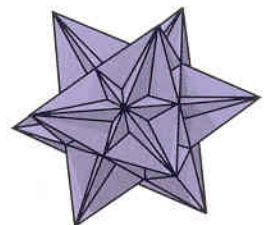

★ Great Icosahedron

大 20 面 体 / だい にじゅうめんたい
(DAI-NIJUU-MEN-TAI)

| | |
|--------------------------|-------------|
| 20 Equilateral Triangles | |
| 30 Edges | 12 Vertices |

- There are three groups of regular and semi-regular polyhedra:
 - ★ The regular tetrahedron group
 - ★ The cube and regular octahedron group
 - ★ The regular dodecahedron and regular icosahedron group

SEMI-REGULAR POLYHEDRON

じゅんせい た めんたい
準正多面体
JUN-SEI-TA-MEN-TAI

- A semi-regular polyhedron is made up of two or three kinds of regular polygonal faces with all vertices having the same structure.
- There are 13 kinds of semi-regular polyhedra. (There are 53 kinds of semi-regular stellated polyhedra.)

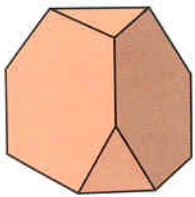

★ Truncated Tetrahedron

切頂4面体/せつちょうしめんたい
(SET-CHOU-SHI-MEN-TAI)

| | | | |
|------------------------------------|----------|-----------------------|--|
| The shapes and the number of faces | 4 | Equilateral Triangles | |
| | 4 | Regular Hexagons | |
| The number of edges and vertices | 18 Edges | 12 Vertices | |

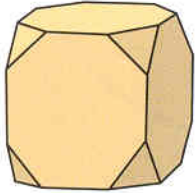

★ Truncated Cube

切頂立方体/せつちょうりっぽうたい
(SET-CHOU-RIP-POU-TAI)

| | | |
|----------|-----------------------|------------------|
| 8 | Equilateral Triangles | |
| | 6 | Regular Octagons |
| 36 Edges | 24 Vertices | |

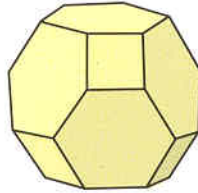

★ Truncated Octahedron

切頂8面体/せつちょうはちめんたい
(SET-CHOU-HACHI-MEN-TAI)

| | | |
|----------|-------------|------------------|
| 6 | Squares | |
| | 8 | Regular Hexagons |
| 36 Edges | 24 Vertices | |

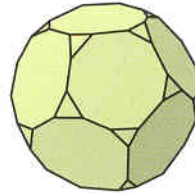

★ Truncated Dodecahedron

切頂12面体/せつちょうじゅうにめんたい
(SET-CHOU-JUUNI-MEN-TAI)

| | | |
|----------|-----------------------|------------------|
| 20 | Equilateral Triangles | |
| | 12 | Regular Decagons |
| 90 Edges | 60 Vertices | |

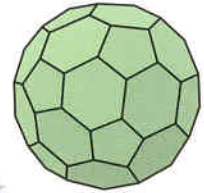

★ Truncated Icosahedron

切頂20面体/せつちょうにじゅうめんたい
(SET-CHOU-NIJUU-MEN-TAI)

| | | |
|----------|-------------------|------------------|
| 12 | Regular Pentagons | |
| | 20 | Regular Hexagons |
| 90 Edges | 60 Vertices | |

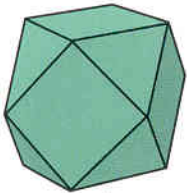

★ Cuboctahedron

立方8面体/りっぽうはちめんたい
(RIP-POU-HACHI-MEN-TAI)

| | | |
|----------|-----------------------|---------|
| 8 | Equilateral Triangles | |
| | 6 | Squares |
| 24 Edges | 12 Vertices | |

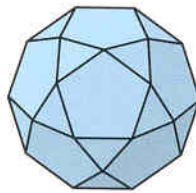

★ Icosidodecahedron

20・12面体/にじゅうじゅうにめんたい
(NIJUU-JUUNI-MEN-TAI)

| | | |
|----------|-----------------------|-------------------|
| 20 | Equilateral Triangles | |
| | 12 | Regular Pentagons |
| 60 Edges | 30 Vertices | |

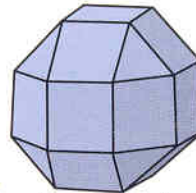

★ Rombicuboctahedron

斜立方8面体/しゃほうりっぽうはちめんたい
(SHA-HOU-RIP-POU-HACHI-MEN-TAI)

| | | |
|----------|-----------------------|---------|
| 8 | Equilateral Triangles | |
| | 18 | Squares |
| 48 Edges | 24 Vertices | |

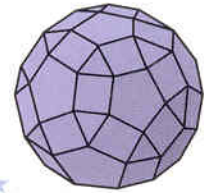

★ Rhombicosidodecahedron

斜方20・12面体
/しゃほうにじゅうじゅうにめんたい
(SHA-HOU-NIJUU-JUUNI-MEN-TAI)

| | | |
|-----------|-----------------------|-------------------|
| 20 | Equilateral Triangles | |
| | 30 | Squares |
| 12 | Regular Pentagons | |
| | 12 | Regular Pentagons |
| 120 Edges | 60 Vertices | |



★ Truncated Cuboctahedron

斜方切頂立方8面体
/しゃほうせつちょうりっぽうはちめんたい
(SHA-HOU-SET-CHOU-RIP-POU-HACHI-MEN-TAI)

| | | |
|----------|------------------|------------------|
| 12 | Squares | |
| | 8 | Regular Hexagons |
| 6 | Regular Octagons | |
| | 6 | Regular Octagons |
| 72 Edges | 48 Vertices | |

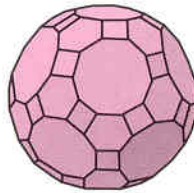

★ Truncated Icosidodecahedron

斜方切頂20・12面体
/しゃほうせつちょうにじゅうじゅうにめんたい
(SHA-HOU-SET-CHOU-NIJUU-JUUNI-MEN-TAI)

| | | |
|-----------|------------------|------------------|
| 30 | Squares | |
| | 20 | Regular Hexagons |
| 12 | Regular Octagons | |
| | 12 | Regular Octagons |
| 180 Edges | 120 Vertices | |



★ Snub Cube

変形立方体/へんけいりっぽうたい
(HEN-KEI-RIP-POU-TAI)

| | | |
|----------|-----------------------|---------|
| 32 | Equilateral Triangles | |
| | 6 | Squares |
| 60 Edges | 24 Vertices | |

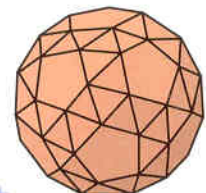

★ Snub Dodecahedron

変形12面体/へんけいじゅうにめんたい
(HEN-KEI-JUUNI-MEN-TAI)

| | | |
|-----------|-----------------------|-------------------|
| 80 | Equilateral Triangles | |
| | 12 | Regular Pentagons |
| 150 Edges | 60 Vertices | |

REGULAR POLYHEDRA

CUBE

● Diagram: Page 34

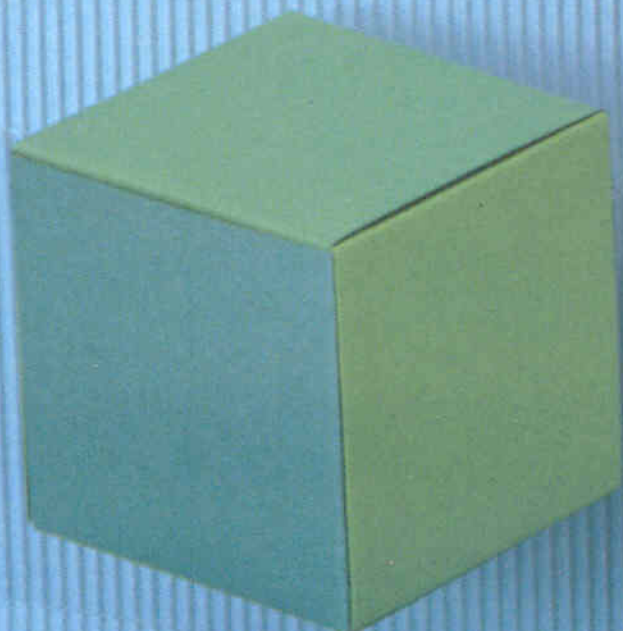

DODECAHEDRON

● Diagram: Page 38



TETRAHEDRON

● Diagram: Page 32



ICOSAHEDRON

● Diagram: Page 40

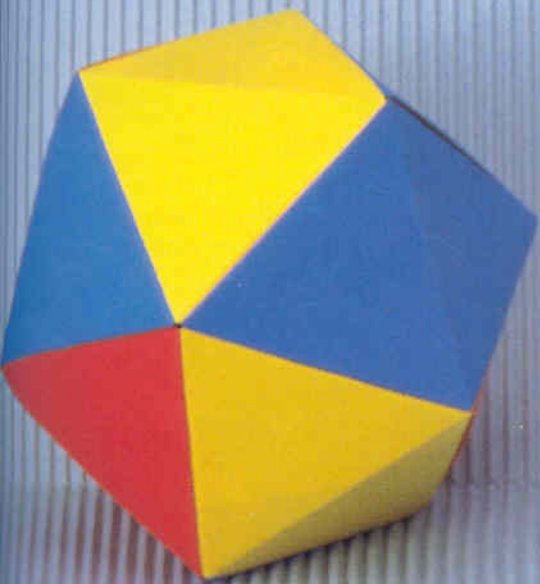

OCTAHEDRON

● Diagram: Page 36

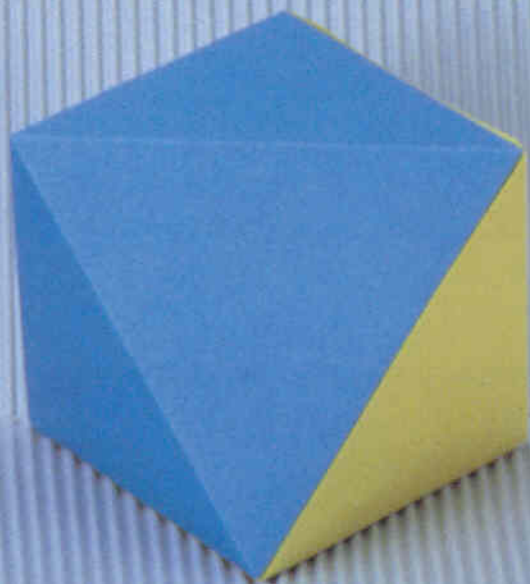

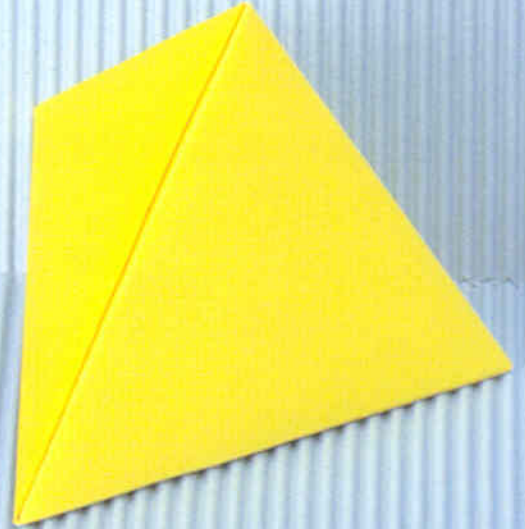
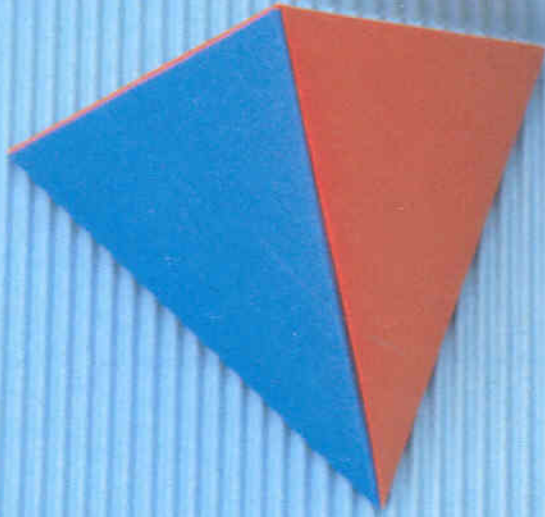

TETRAHEDRON

せい し めん たい
正 4 面 体
SEI - SHI - MEN - TAI

You need 2 square pieces of paper, both the same size.

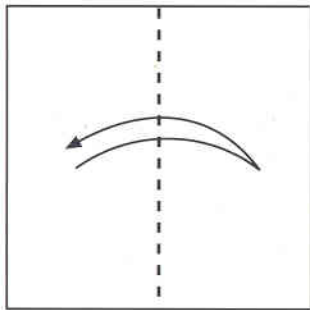

① Fold in half and unfold.

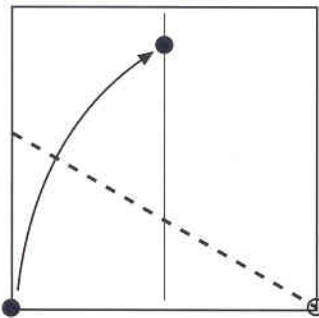

② Bring the lower left corner to the center line and fold. Make sure the fold goes through the lower right corner.

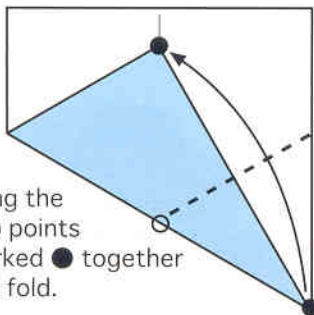

③ Bring the two points marked ● together and fold.

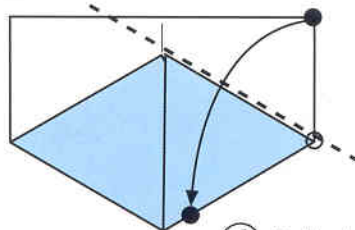

④ Fold along the edge.

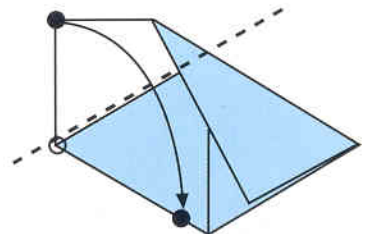

⑤ Fold along the edge.

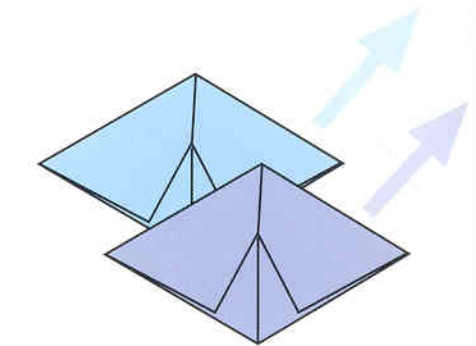

⑥ You need 2 identical pieces. Unfold both back to a square.

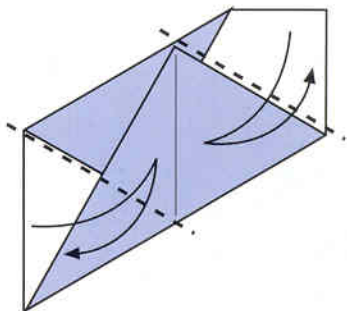
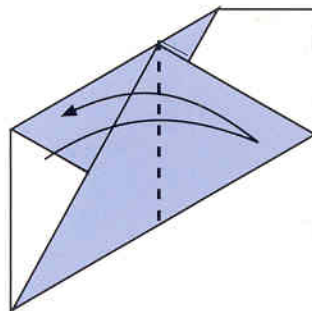
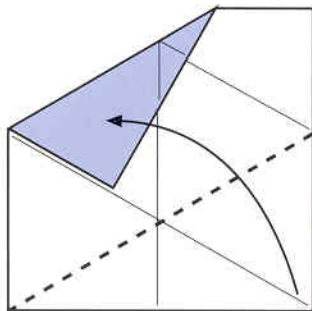
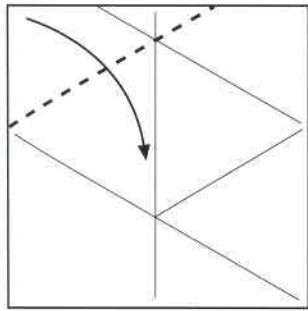
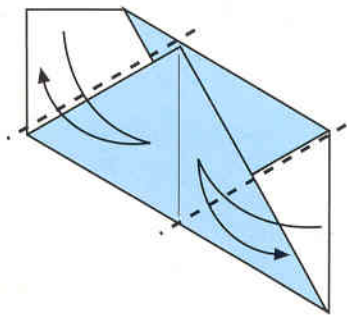
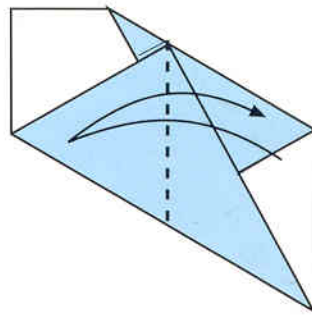
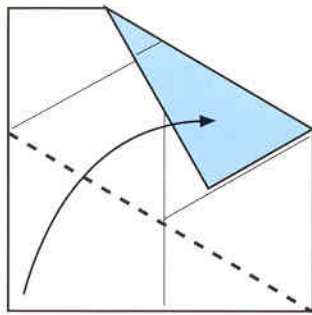
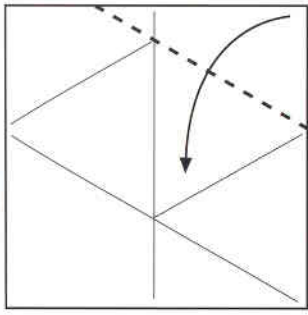

7 Fold along the existing crease line.
(Each unit is different!)

8 Fold along the existing crease line.

9 Fold and unfold.

10 Fold and unfold. These are the 2 Tetrahedron Modules.

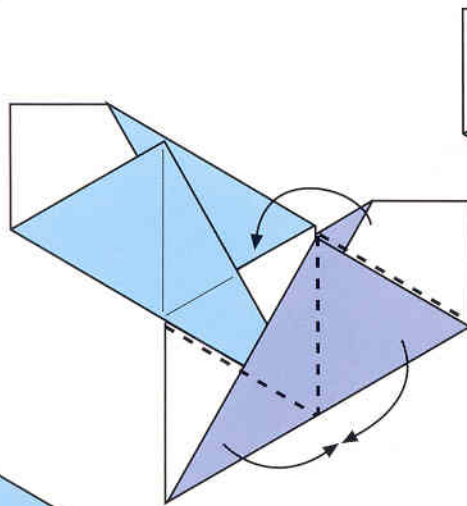

11 Insert.

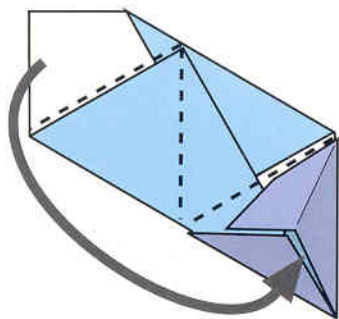

12 Raise up along the three crease lines and make a mountain shape.

13 Tuck the flap into the slot.

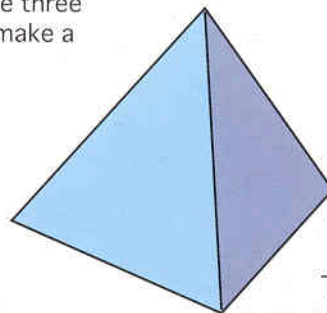

The completed TETRAHEDRON

CUBE

リッ ほう たい
立方体
RIP - POU - TAI

● This "Cube" is a slightly different arrangement of the "Cube" by Paul Jackson.

You need 6 square pieces of paper, all the same size.

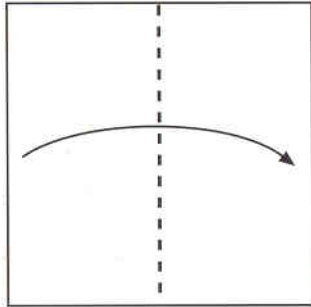

① Fold in half.

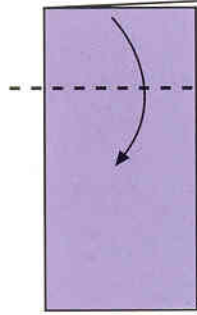

② Fold at about the quarter line.

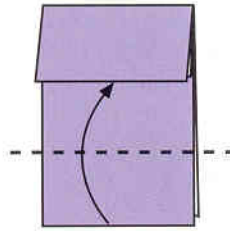

③ Bring the bottom edge up to the other edge of the paper and fold.

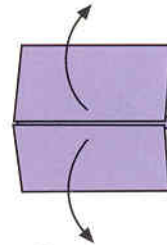

④ Unfold.

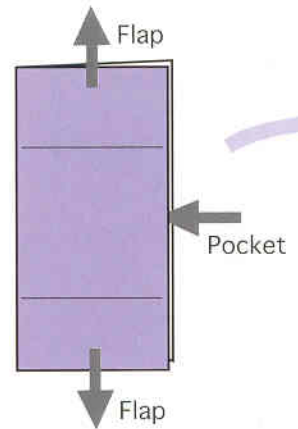

⑤ This is the Cube Module. You need 6 modules.

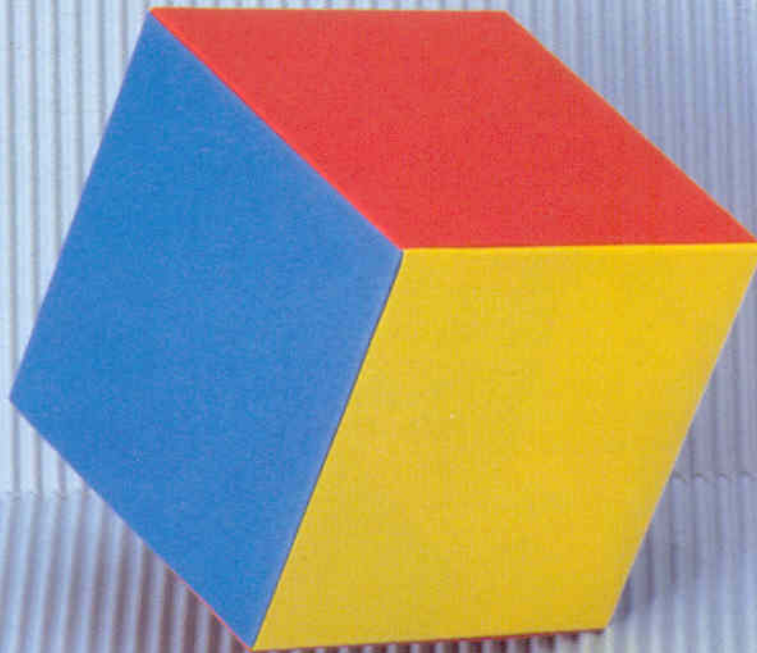



⑥ Insert.

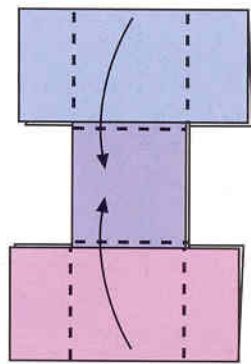

⑦ Raise up along the two crease lines.

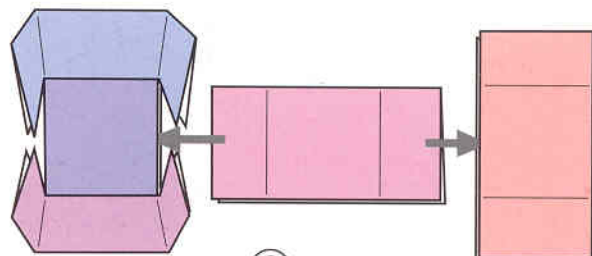

⑧ Insert.

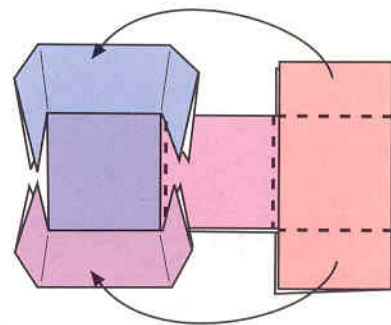

⑨ Raise up along a crease line, tuck in the two flaps and make a box shape.

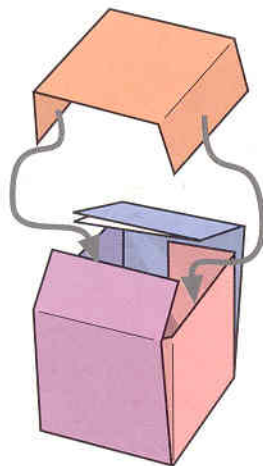

⑩ Tuck in the two flaps of the last module.

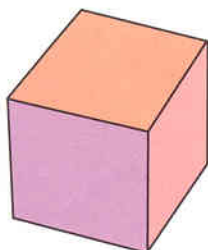

The completed
CUBE

OCTAHEDRON

せい はち めん たい
正 8 面 体
SEI - HACHI-MEN - TAI

You need 4 square pieces of paper, all the same size.

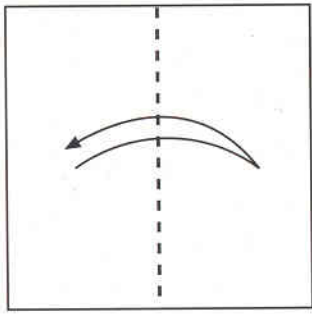

① Fold in half and unfold.

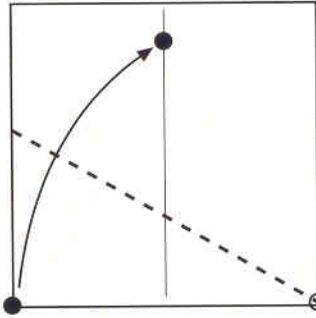

② Bring the lower left corner to the center line and fold. Make sure the fold goes through the lower right corner.

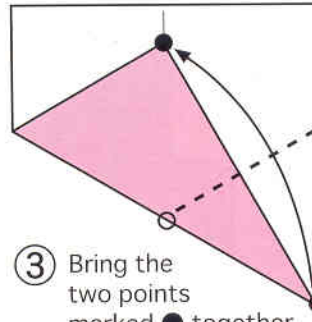

③ Bring the two points marked ● together and fold.

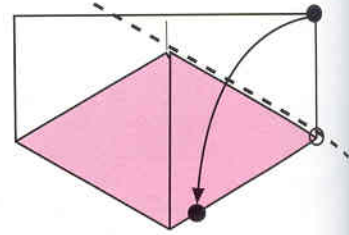

④ Fold along the edge.

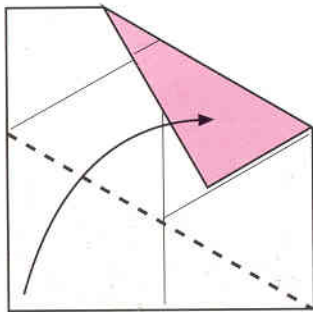

⑤ Fold along the edge.

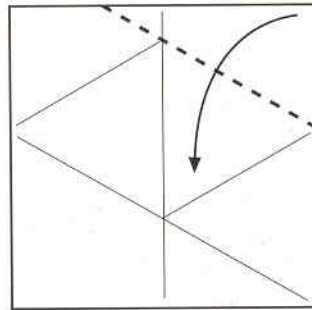

⑥ Unfold back to a square.

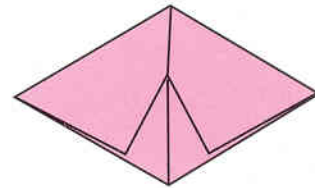

⑦ Fold along the existing crease line.

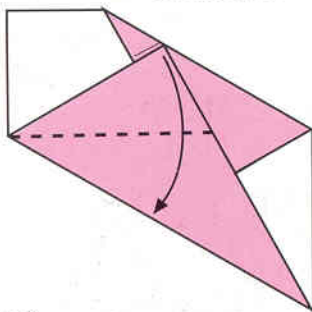

⑧ Fold along the existing crease line.

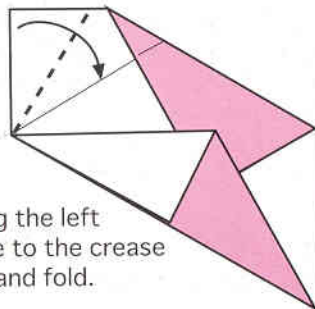

⑨ Bring the left edge of the top layer to the bottom edge and fold.

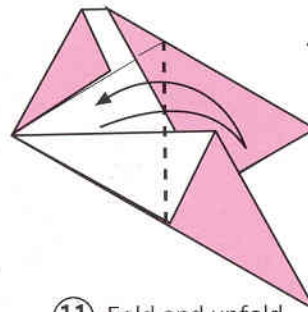

⑩ Bring the left edge to the crease line and fold.

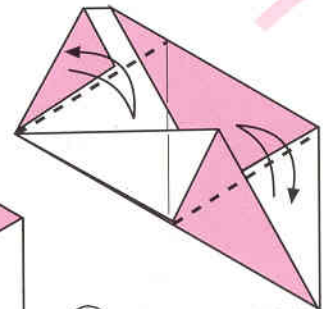

⑪ Fold and unfold.

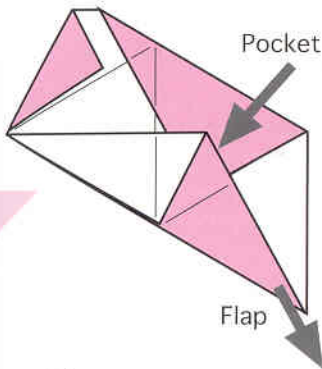
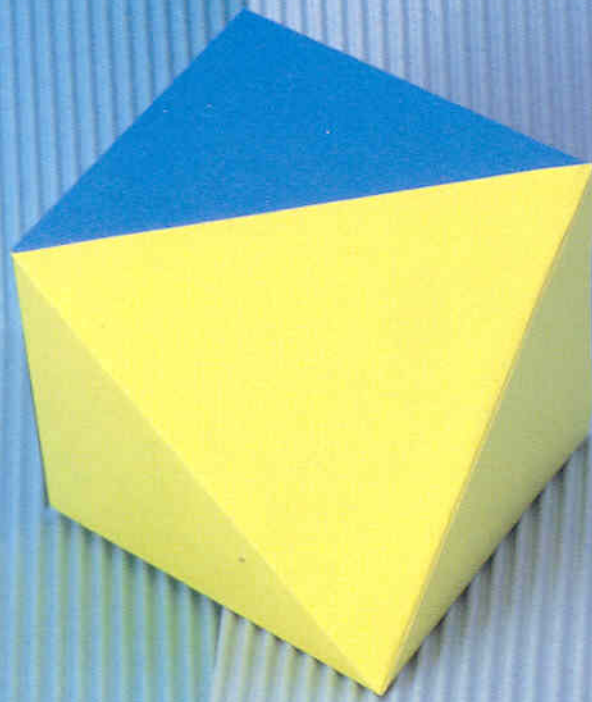

⑬ This is the Octahedron Module. You need 4 modules.

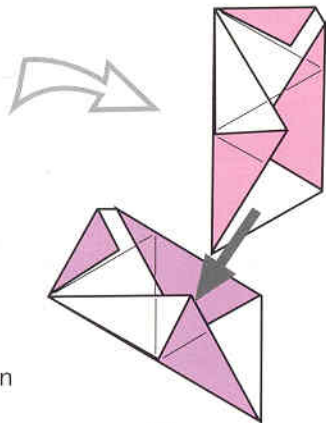

⑭ Insert.

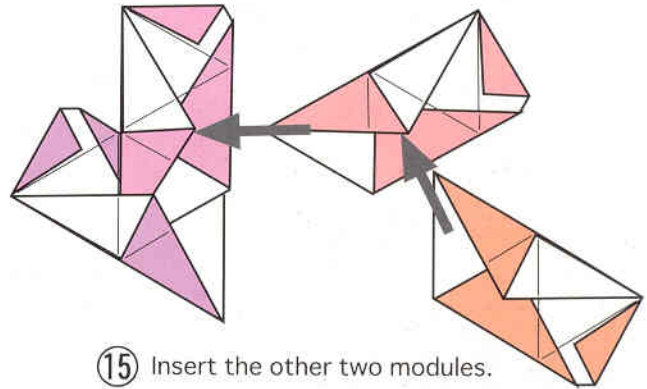

⑮ Insert the other two modules.

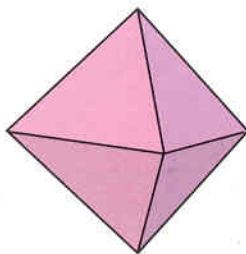

The completed
OCTAHEDRON

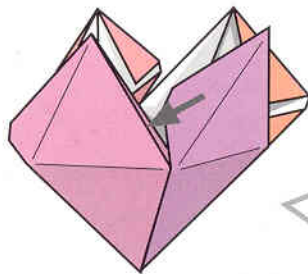

⑰ Tuck the flap into the next pocket and repeat for the other three flaps.

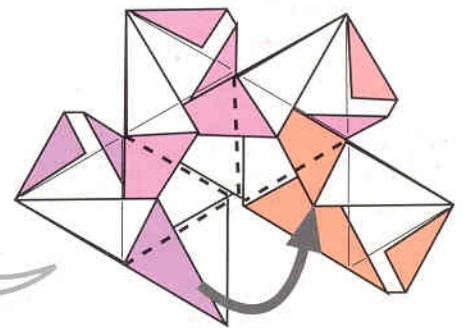

⑯ Tuck the flap into the pocket and make a cup shape.

DODECAHEDRON

せいじゅうにめんたい
正 12 面体
SEI - JUUNI - MEN - TAI

You need 12 square pieces of paper,
all the same size.

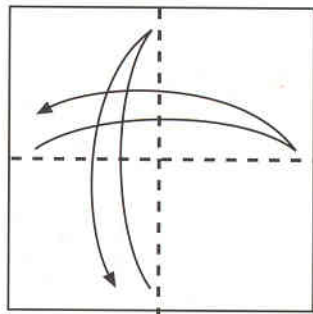

- ① Fold and unfold.
Do the same in the
other direction.

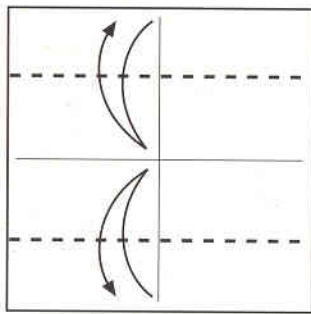

- ② Fold the bottom edge
up to the center line
and fold. Do the same
with the upper edge.

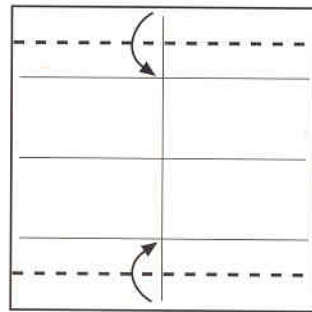

- ③ Fold the bottom edge
up to the quarter line
and fold. Do the same
with the upper edge.

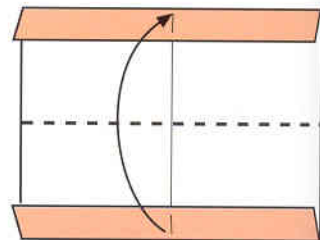

- ④ Fold the bottom edge
up to the top.

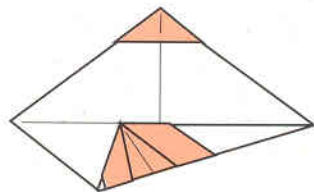

- ⑦ Bring the lower right
edge up to the center
line and fold.

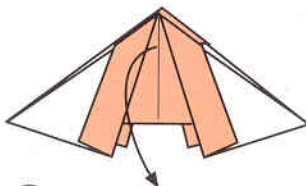

- ⑥ Open the model. The
lower corners will overlap
on the back.

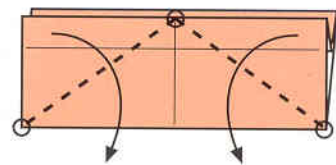

- ⑤ Fold just the upper layer
in front. Do the same on
the reverse side.

- ⑧ Unfold back to a square.

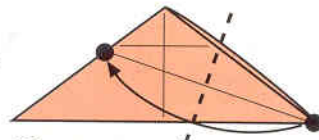

- ⑬ Bring the two points
marked ● together
and fold.

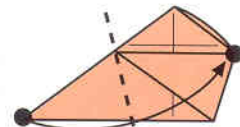

- ⑭ Bring the two points
marked ● together
and fold.

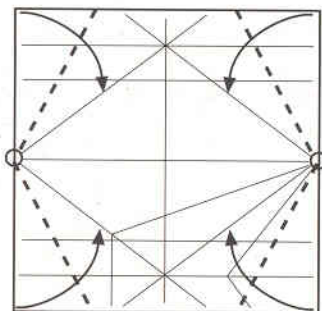

- ⑨ Bring the four edges to
each of the crease lines.

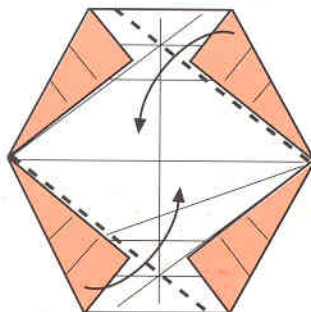

- ⑩ Fold along the two
crease lines.

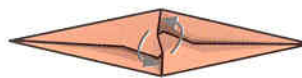

In process
(Top view)

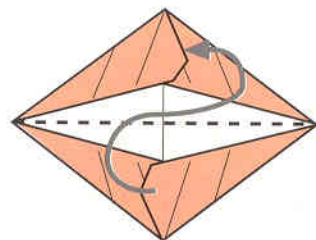

- ⑫ Fold in half and
interlock the flaps.

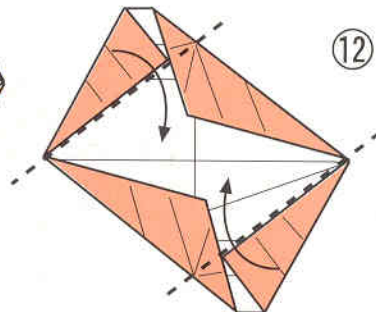

- ⑪ Fold along the two crease lines.

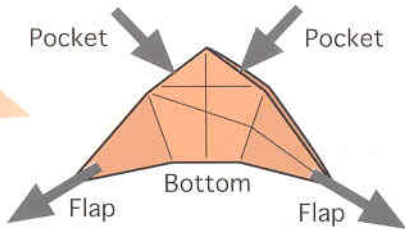

15 This is the Dodecahedron Module. You need 12 modules.

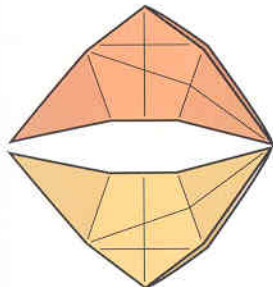

16 Place two modules bottom to bottom.

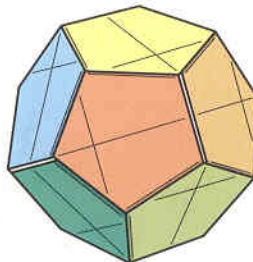

The completed DODECAHEDRON

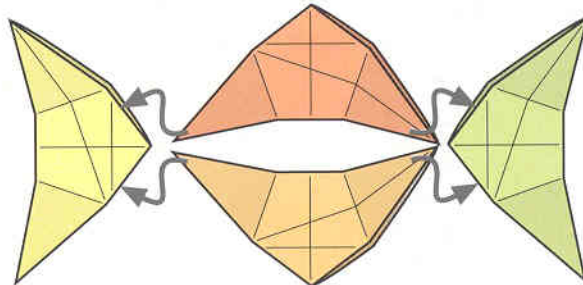

17 Insert two modules as shown in the diagram.

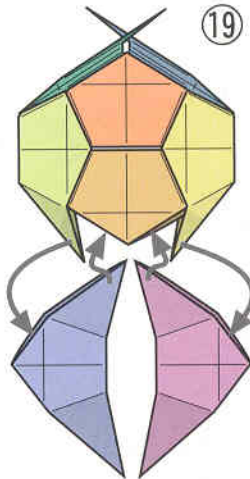

19 Insert all the other modules the same way, each pair aligned bottom to bottom.

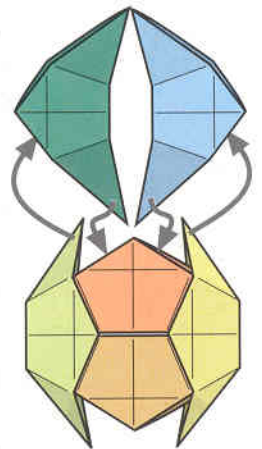

Turn the model over

18 Insert another pair of modules.

ICOSAHEDRON

せい にじゅうめんたい
正 20 面体
SEI - NIJUJU - MEN - TAI

You need 10 square pieces of paper, all the same size.

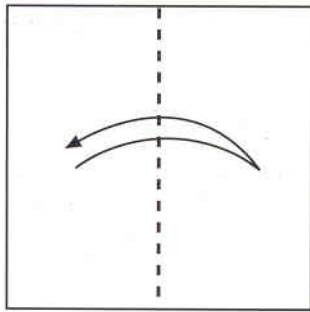

① Fold in half and unfold.

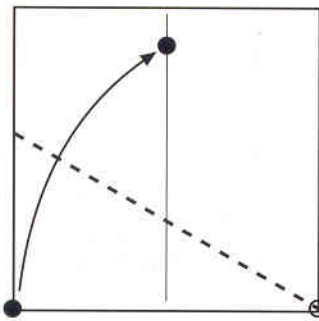

② Bring the lower left corner to the center line and fold. Make sure the fold goes through the lower right corner.

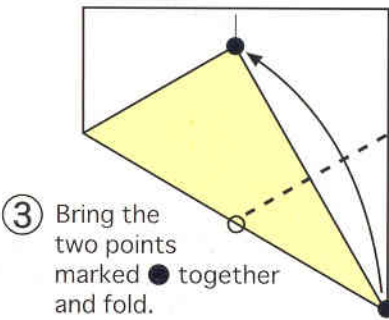

③ Bring the two points marked ● together and fold.

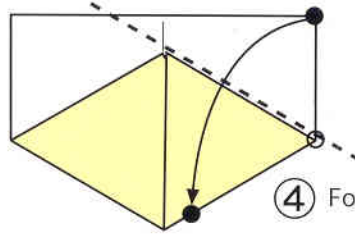

④ Fold along the edge.

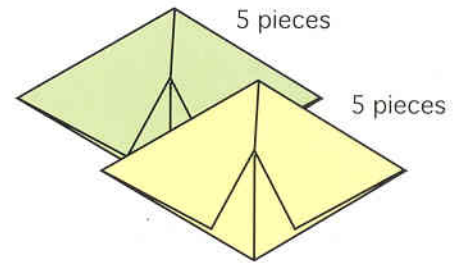

⑥ You need 10 identical pieces. Unfold all of them back to a square.

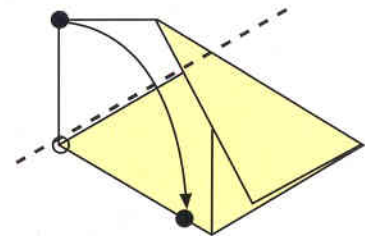

⑤ Fold along the edge.

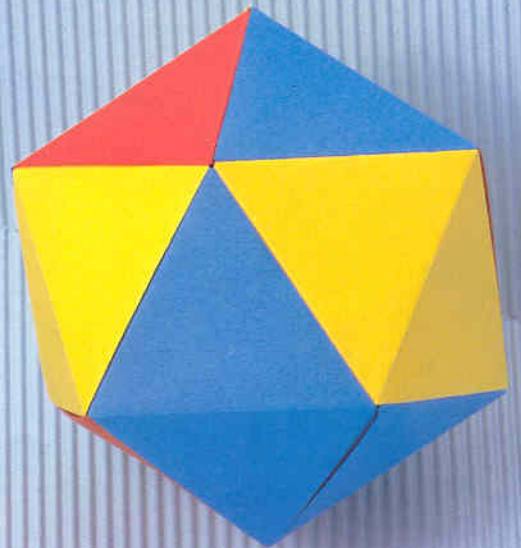
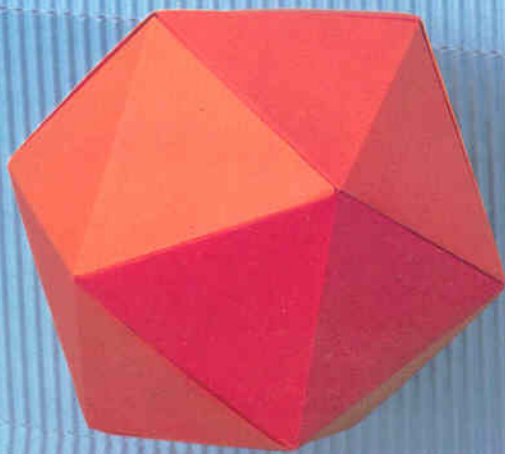

Type A

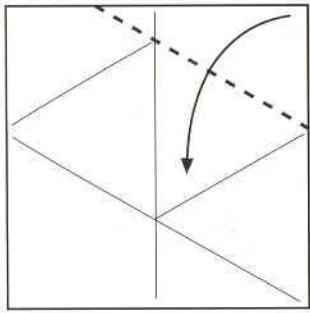

7 Fold along the existing crease line.

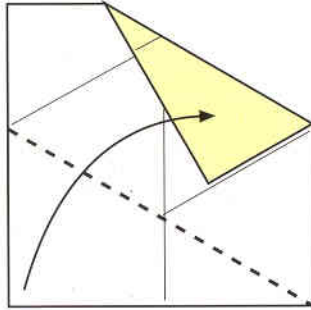

8 Fold along the existing crease line.

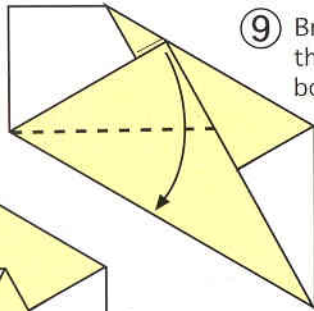

9 Bring the left edge of the top layer to the bottom edge and fold.

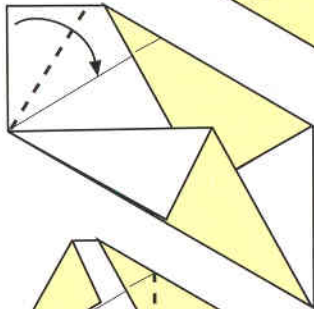

10 Bring the left edge to the crease line and fold.

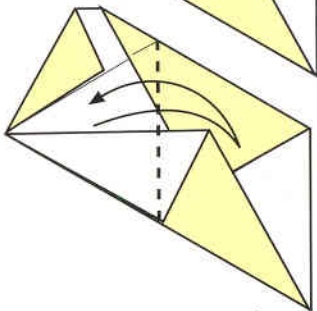

11 Fold and unfold.

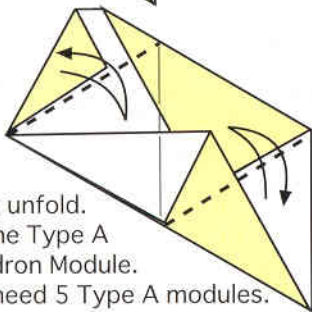

12 Fold and unfold. This is the Type A Icosahedron Module. You need 5 Type A modules.

Type B

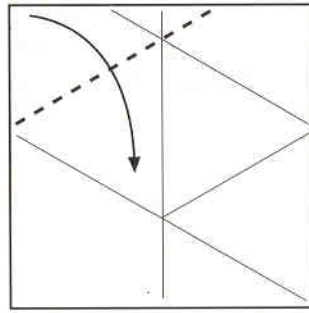

7 Fold along the existing crease line.

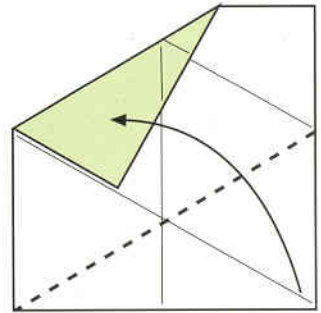

8 Fold along the existing crease line.

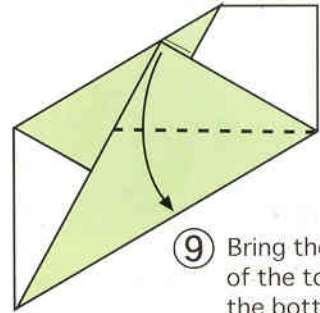

9 Bring the left edge of the top layer to the bottom edge and fold.

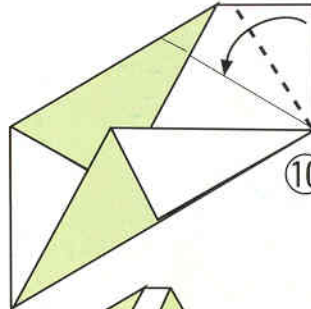

10 Bring the left edge to the crease line and fold.

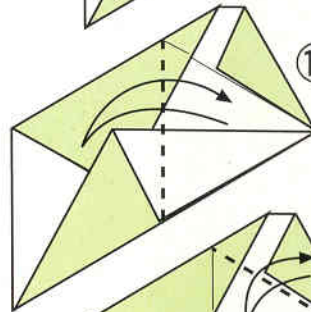

11 Fold and unfold.

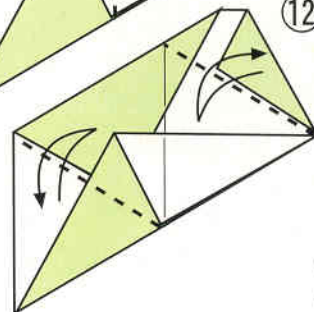

12 Fold and unfold. This is the Type B Icosahedron Module. You need 5 Type B modules.

Continued on the next page.

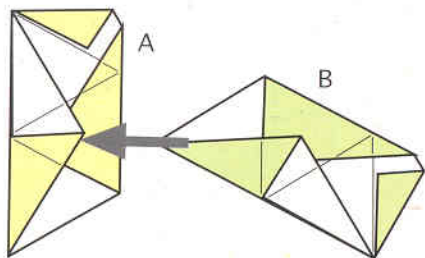

- ⑬ Tuck the flap of a Type B module into the pocket of a Type A module.

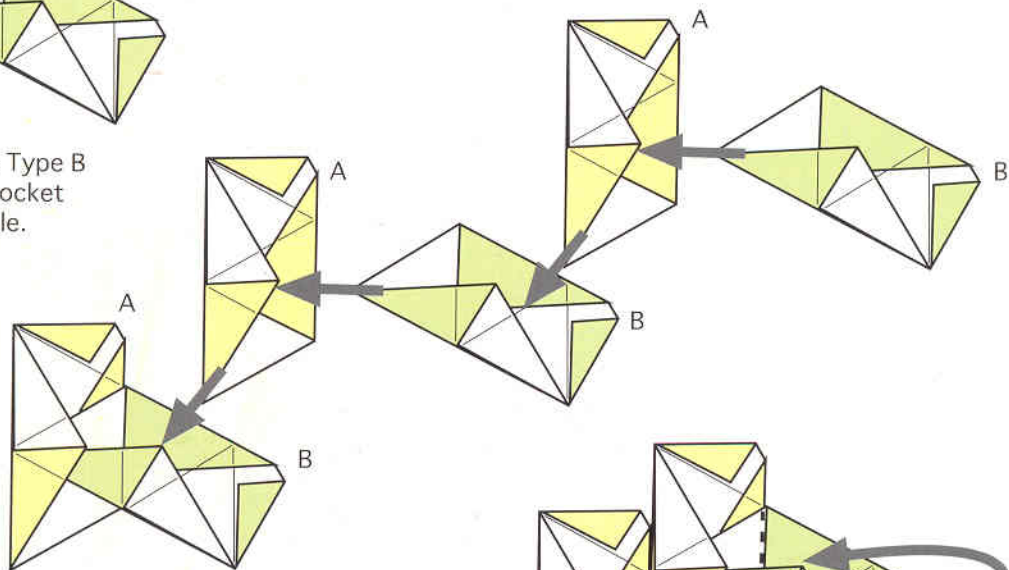

- ⑭ Put together the other eight modules as shown in the diagram. (You can use glue to make a strong model.)

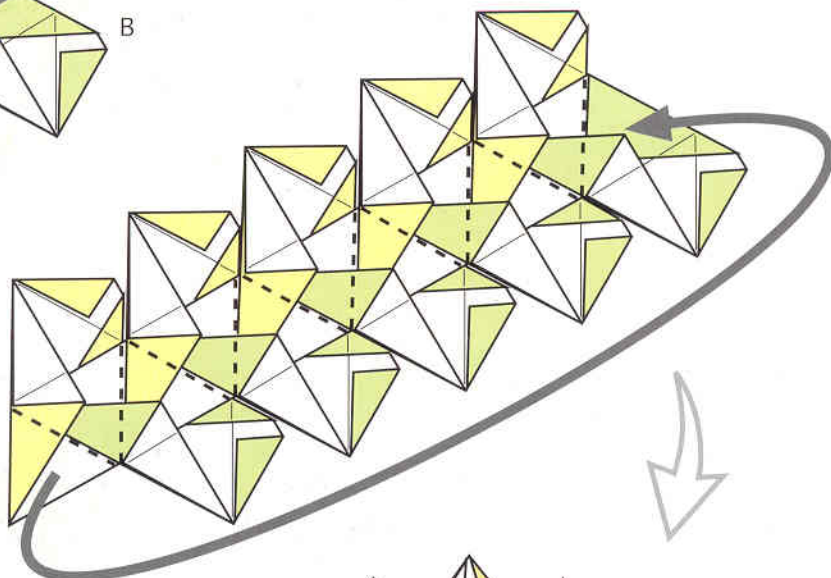

- ⑮ Tuck the flap into the pocket on the other end and make a cylinder shape.

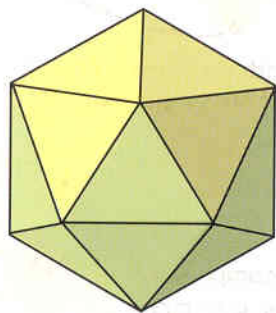

The completed
ICOSAHEDRON

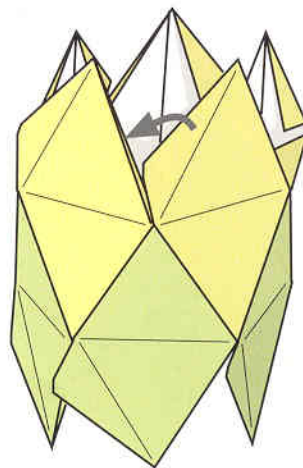

- ⑯ Tuck the flap into the next pocket and repeat for the other nine flaps.

PAPER BALLOON

かみ ふう せん
紙 風 船
KAMI: FUU - SEN



You need 6 square pieces of paper, all the same size.

- ① Glue five sheets of square paper as shown in the diagram.

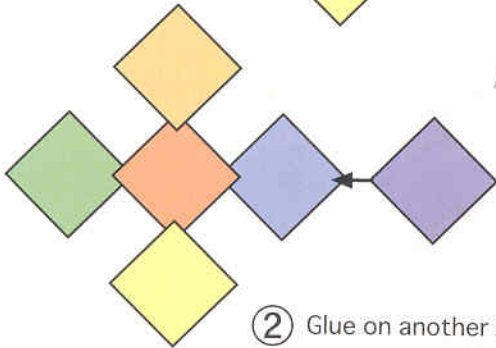
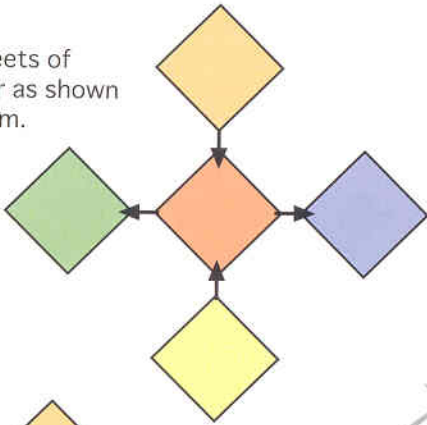

- ② Glue on another one.

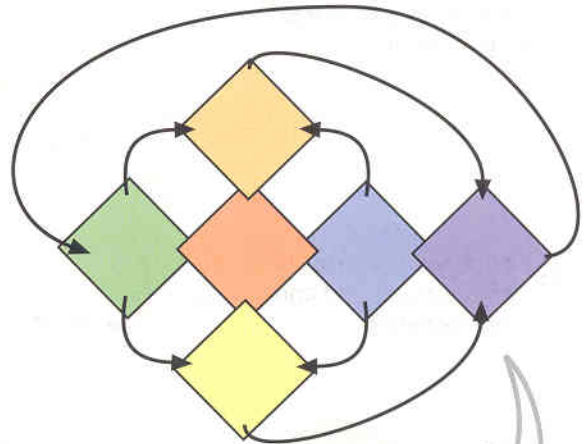

- ③ Put together the corners and glue as shown in the diagram.

The completed
PAPER BALLOON

This model is fun
to toss around!

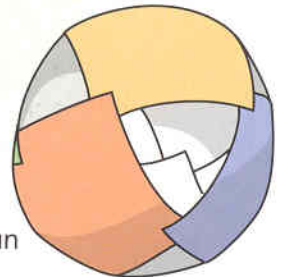

POLYHEDRAL SKELETONS

ICOSAHEDRAL SKELETON

● Diagram: Page 54

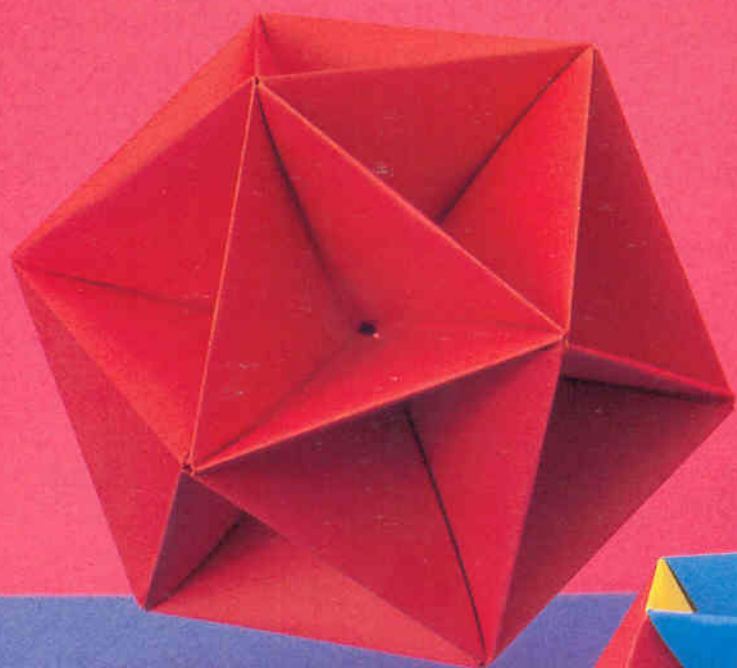

OCTAHEDRAL SKELETON

● Diagram: Page 50



DODECAHEDRAL SKELETON

● Diagram: Page 52

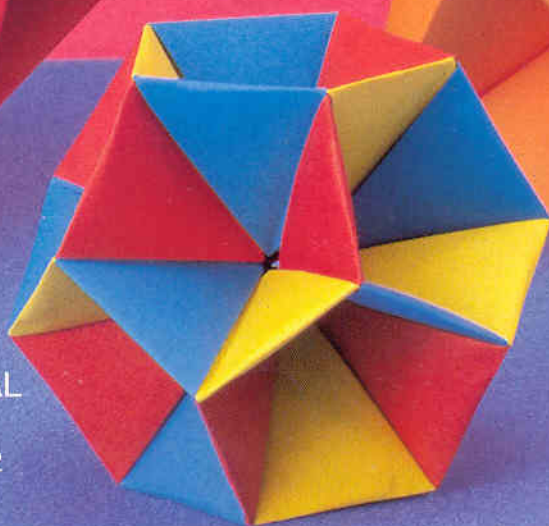

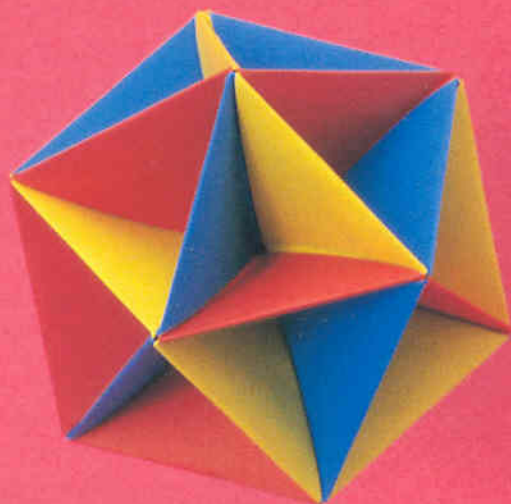

CUBE SKELETON

● Diagram: Page 48

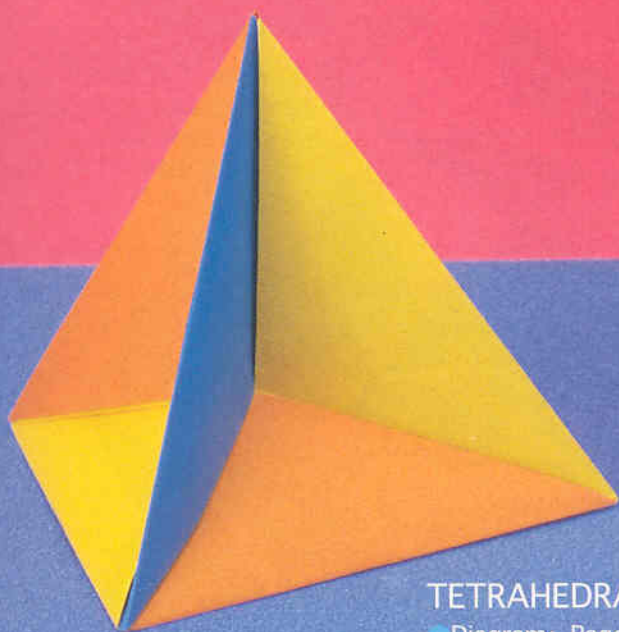

TETRAHEDRAL SKELETON

● Diagram: Page 46

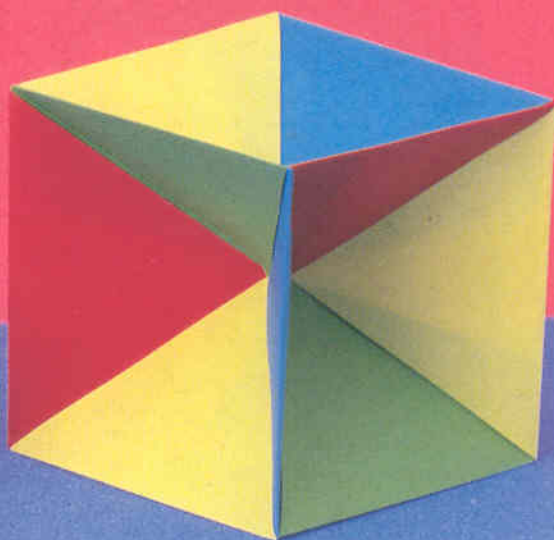

TETRAHEDRAL SKELETON

せいしめんたい すける とん
正四面体のスケルトン
SEI-SHI-MEN-TAI NO SU-KE-RU-TO-N

You need 6 square pieces of paper, all the same size.

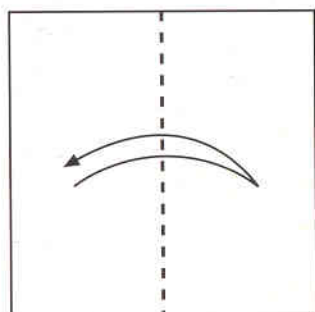

① Fold in half and unfold.

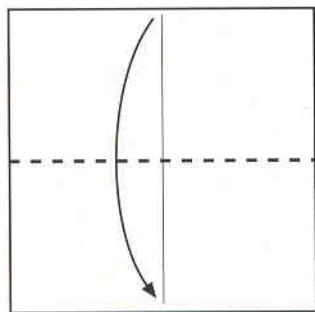

② Fold in half.

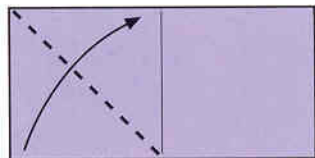

③ Fold only one layer, bringing the left edge to the top edge.

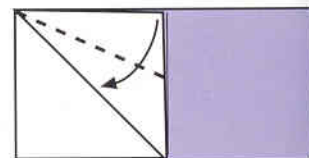

④ Fold only one layer, bringing the top edge to the slanted edge.

Turn the model over

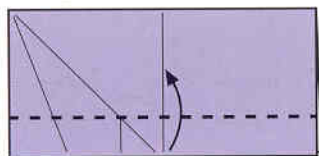
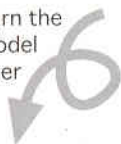

⑦ Fold only one layer along the crease line.

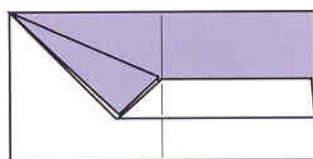

⑥ Unfold back to step ③.

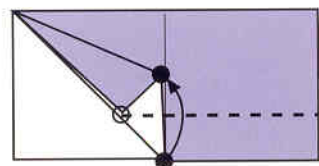

⑤ Bring the two points marked ● together and fold only one layer.

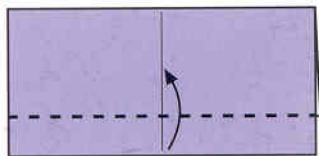

⑧ Fold along the edge of the reverse side.

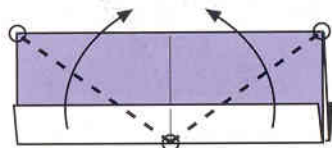

⑨ Fold only one layer.

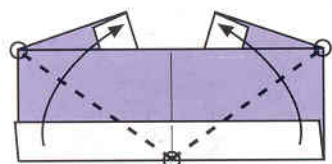

⑩ Do the same on the reverse side.

Turn the model over

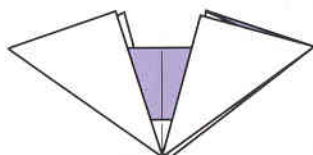

⑪ Unfold back to a square.

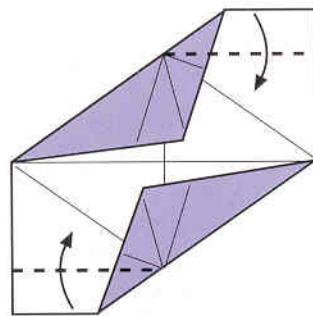

⑭ Fold along the two crease lines.

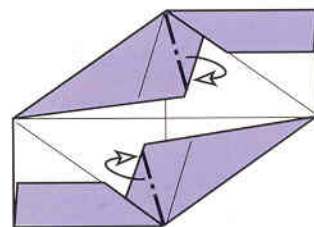

⑮ Tuck the two small triangles under the top layer and pull out the two hidden parts as shown in the next diagram.

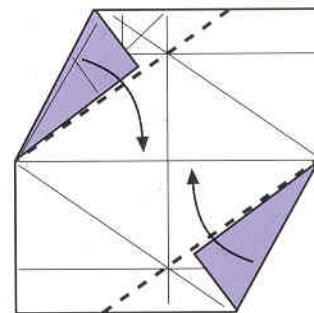

⑬ Fold along the two crease lines.

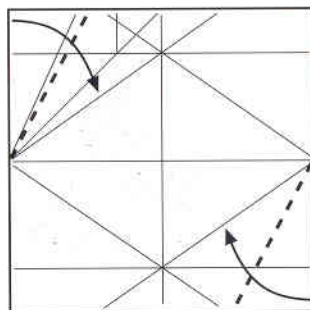

⑫ Fold by bringing the left edge to the slanted crease line. Do the same on the right edge.

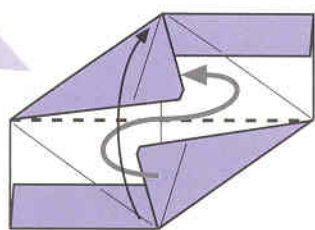
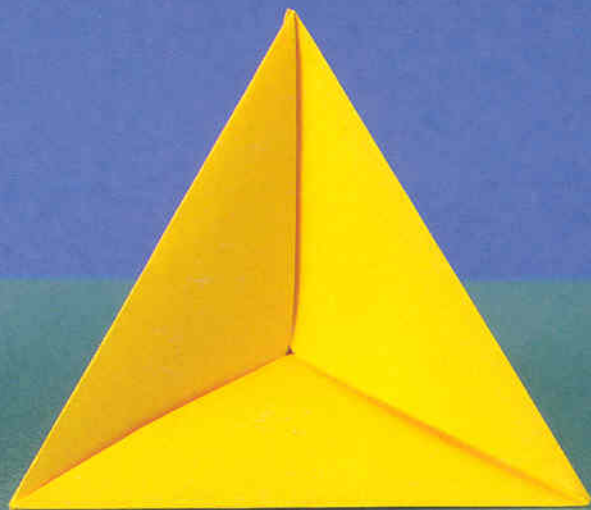
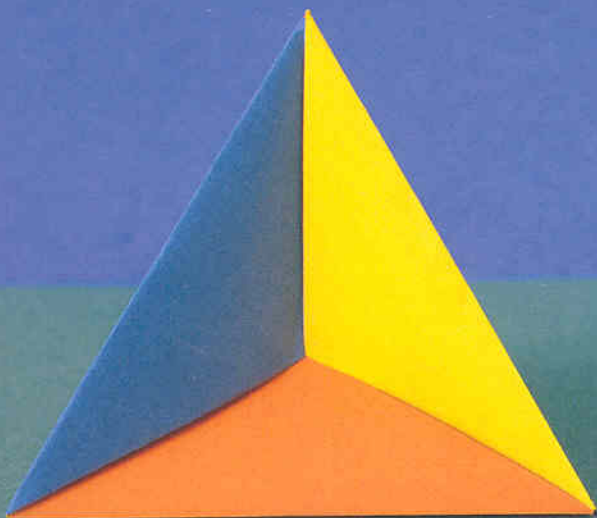

16 Fold in half and interlock the flaps.

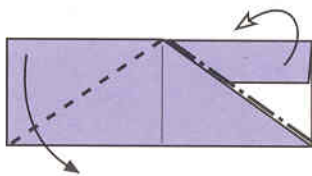

17 Fold along the edges.



18 Fold a little above the bottom edge. Do the same on the reverse side.

Turn the model over

21

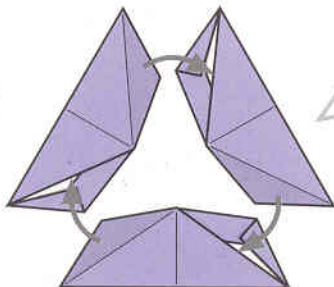
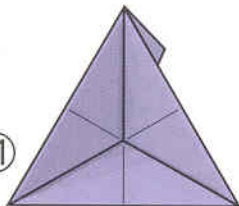

20 Insert the flaps into the pockets all around and make a dish shape.

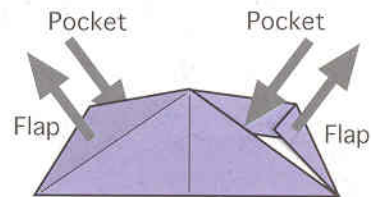

19 This is the Tetrahedral Skeleton Module. You need 6 modules.

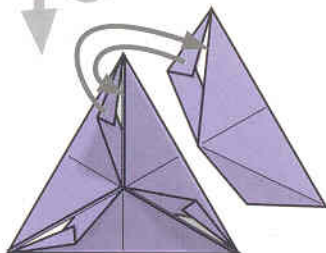

22 Insert the flap on the new piece into the pocket on the dish shape. Then insert the flap on the dish shape into the pocket on the new piece.

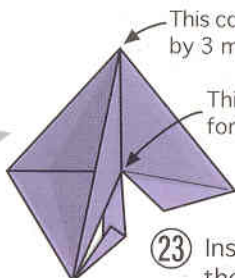

This corner is formed by 3 modules.

This interior corner is also formed by 3 modules.

23 Insert the other modules the same way.

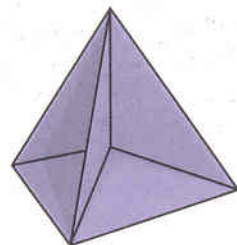

The completed TETRAHEDRAL SKELETON

CUBE SKELETON

りっぽうたい すけるとん
立方体のスケルトン
RIP-POU-TAI NO SU-KE-RU-TO-N

You need 12 square pieces of paper, all the same size.

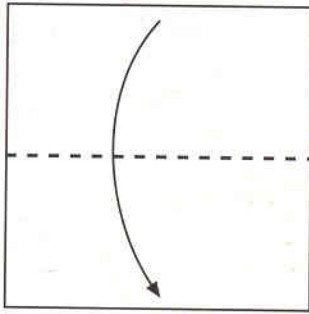

① Fold in half.

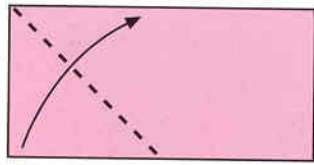

② Fold only one layer, bringing the left edge to the top edge.

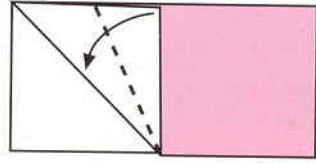

③ Fold only one layer, bringing the right edge to the slanted edge.

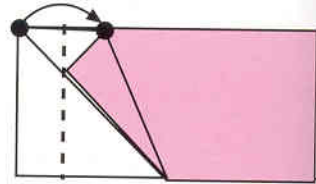

④ Bring the two points marked ● together and fold.

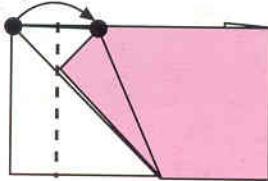

⑧ Bring the two points marked ● together and fold.

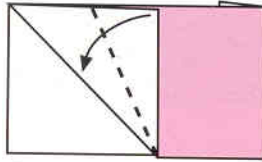

⑦ Fold only one layer, bringing the right edge to the slanted edge.

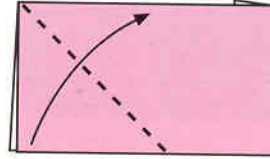

⑥ Fold only one layer, bringing the left edge to the top edge.

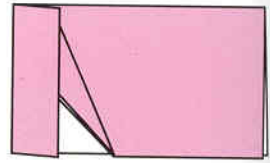

⑤ Turn the model over.

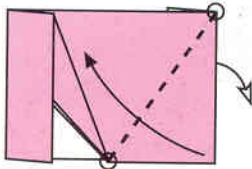

⑨ Fold the corner up and to the left as shown. Allow the flap at the back to swing out to the right.

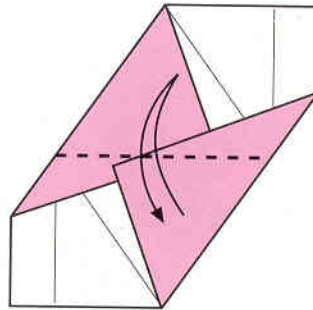

⑭ Fold and unfold.

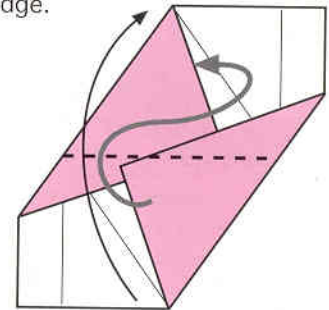

⑮ Fold in half and interlock the flaps.

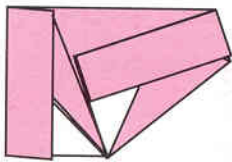

⑩ Turn the model over.

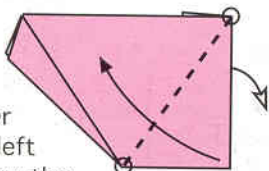

⑪ Fold the corner up and to the left as shown. Allow the flap at the back to swing out to the right.

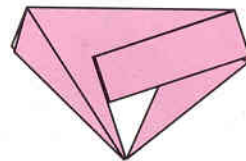

⑫ Unfold back to a square.

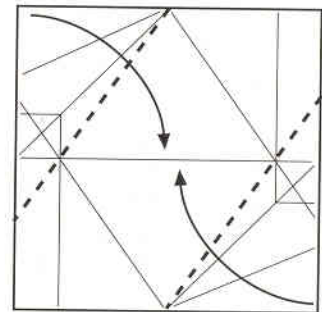

⑬ Fold along the two crease lines.

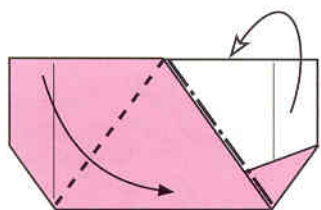
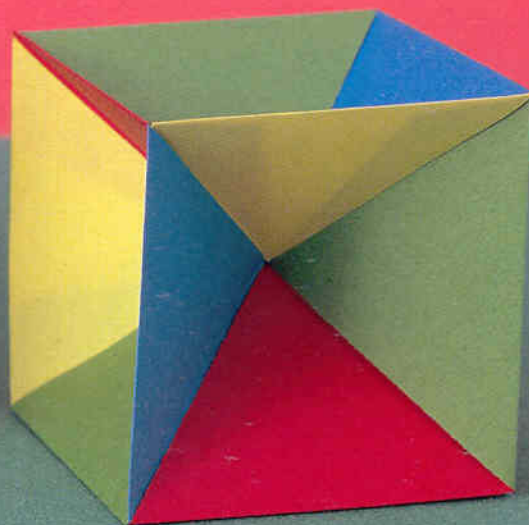
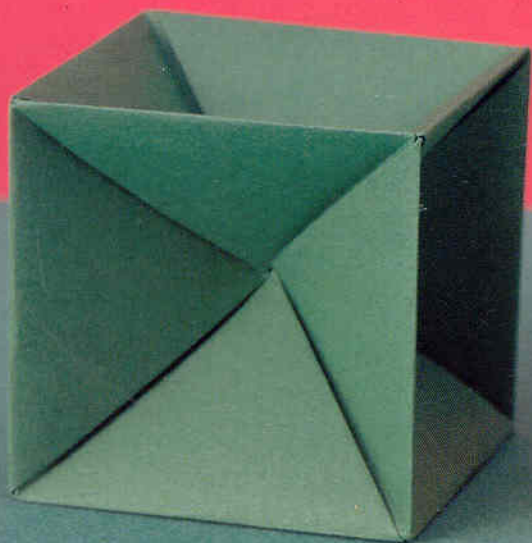

16 Fold along the edges.

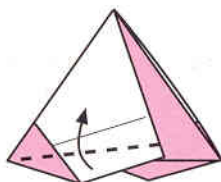

17 Fold a little above the bottom edge. Do the same on the reverse side.

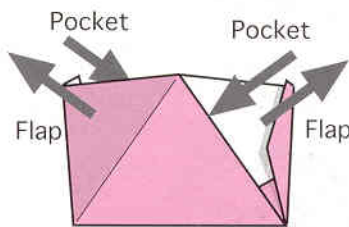

18 This is the Cube Skeleton Module. You need 12 modules.

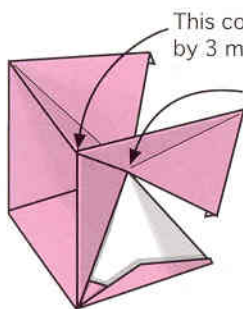

22 Insert the other modules the same way.

This interior corner is formed by 4 modules.

The completed CUBE SKELETON

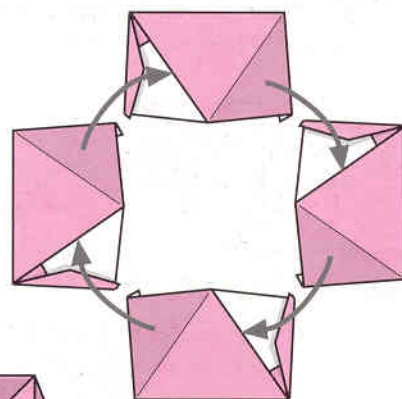
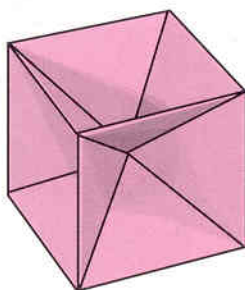

19 Insert the flaps into the pockets all around and make a dish shape.

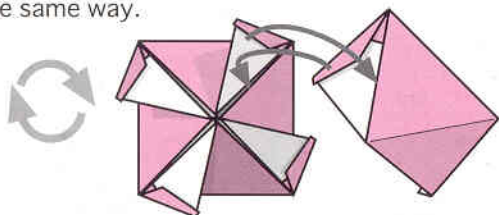

21 Insert the flap on the new piece into the pocket on the dish shape. Then insert the flap on the dish shape into the pocket on the new piece.

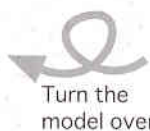

Turn the model over

20

OCTAHEDRAL SKELETON

せいばちめんたい すける とん
 正 8 面 体 の スケルトン
 SEI-HACHI-MEN-TAI NO SU-KE-RU-YO-N

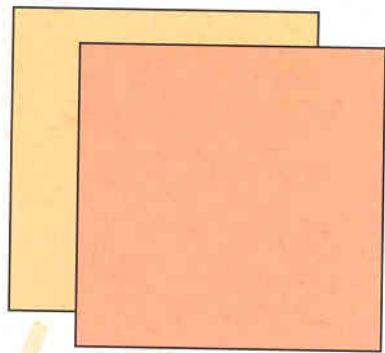

① You need 2 square pieces of paper, both the same size.

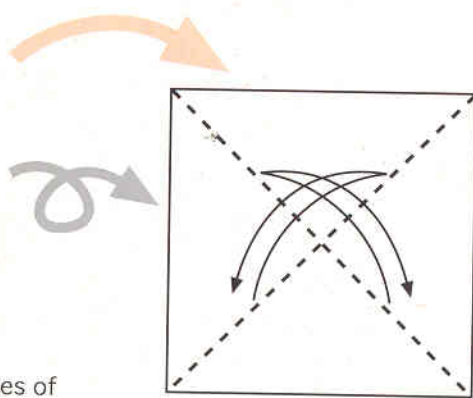

② Fold and unfold.

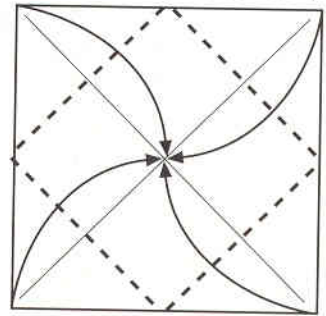

③ Bring each corner to the center point and fold.

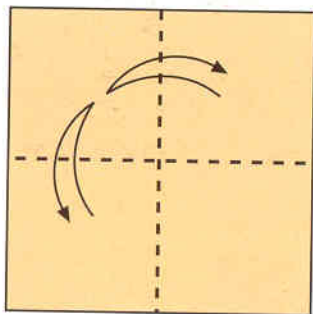

② Fold and unfold.

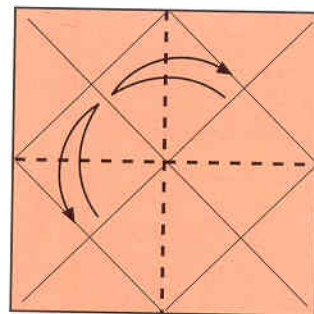

⑤ Fold and unfold.

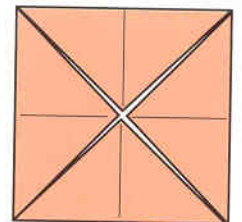

④ Unfold back to a square.



Turn the model over

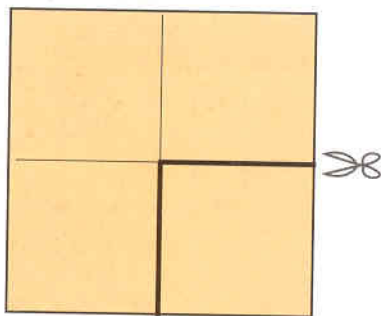

③ Cut the paper along the crease lines.

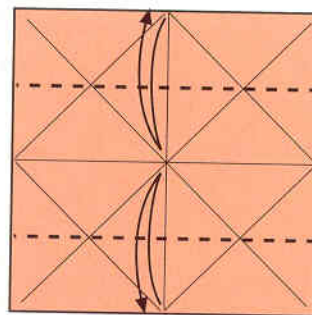

⑥ Fold and unfold.

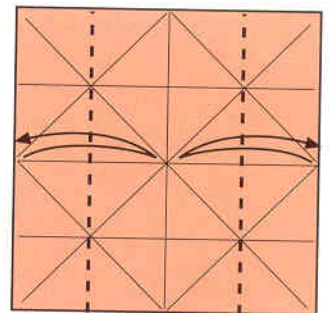

⑦ Fold and unfold.

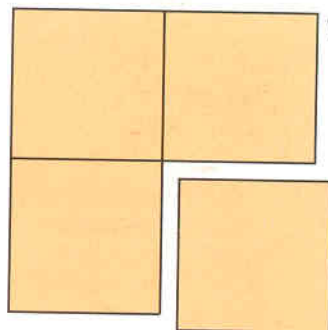

④ You need 1 small piece of paper.

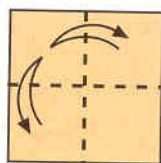

⑤ Fold and unfold.

Turn the model over

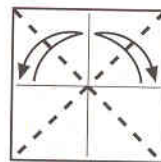

⑥ Fold and unfold.

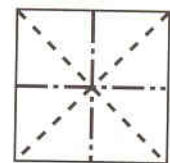

⑦ Fold by using all the creases at the same time.

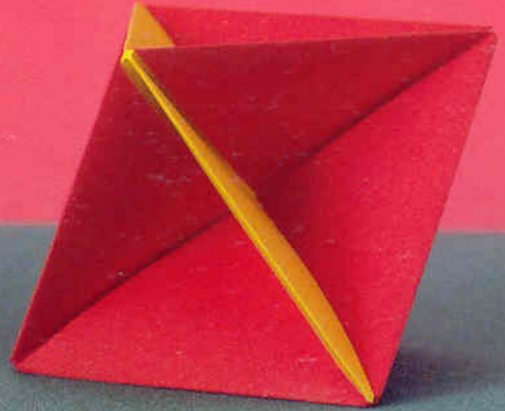
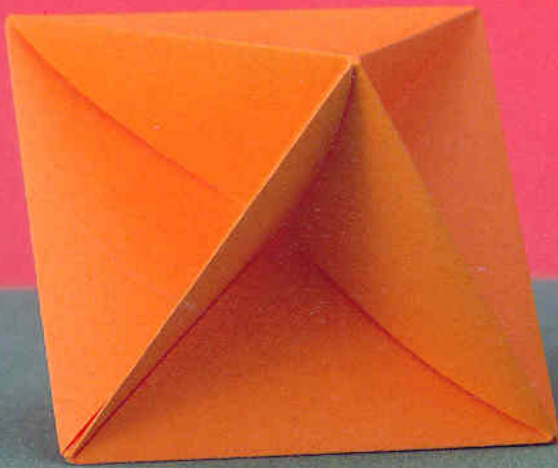

Turn the model over

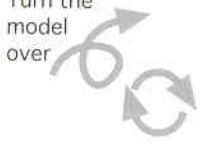

- ⑨ Fold along all the crease lines. The model will become 3-D.

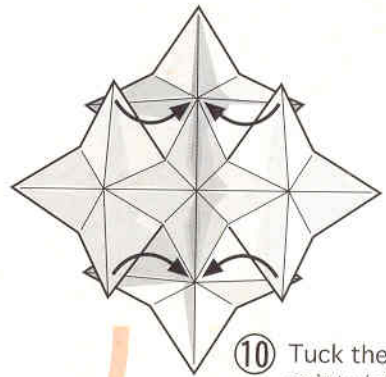
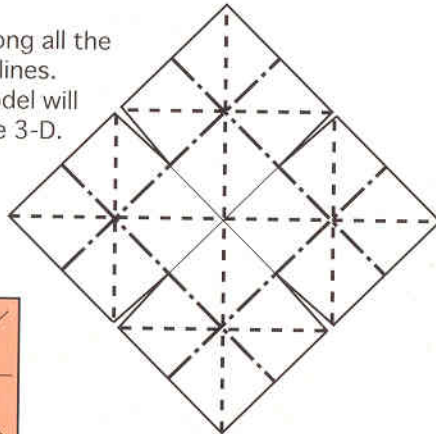

- ⑩ Tuck the four points into the inside as shown in the diagram.

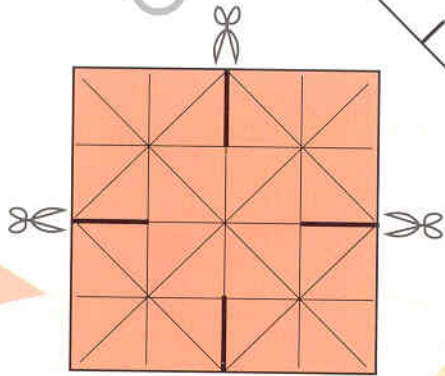

- ⑧ Cut.

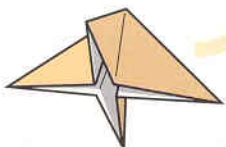

- ⑧ This is the cap.

- ⑪ Tuck the two points of the cap marked ⊙ inside two points of the lower piece. Do the opposite with the other cap points.

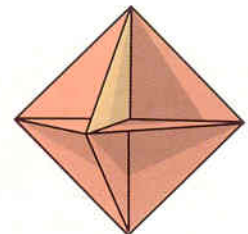
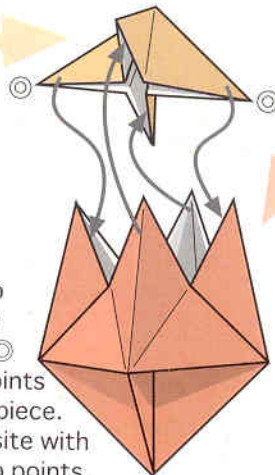

The completed OCTAHEDRAL SKELETON

DODECAHEDRAL SKELETON

せいじゅうにめんたい すける とん
 正 12 面体のスケルトン
 SEI - JUUNI - MEN - TAI NO SU - KE - RU - TO - N

You need 30 square pieces of paper, all the same size.

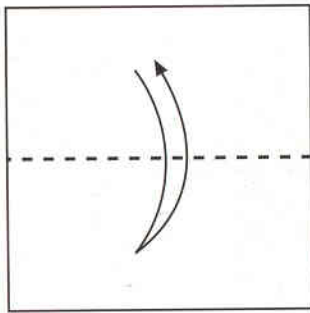

① Fold in half and unfold.

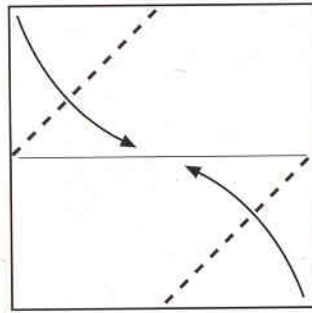

② Bring the lower right edge to the center line and fold. Do the same on the upper side.

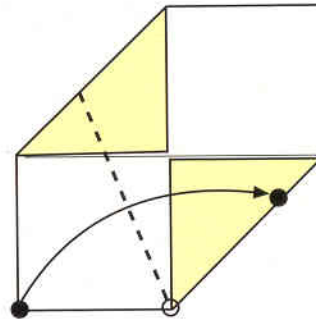

③ Bring the bottom edge to the right slanted edge and fold.

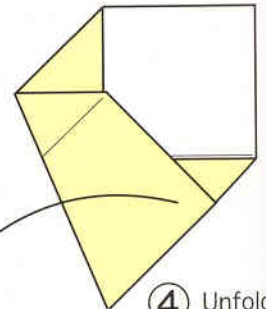

④ Unfold.

⑦ Bring the lower right corner to a point a little inside the crease and fold. Do the same on the upper left corner.

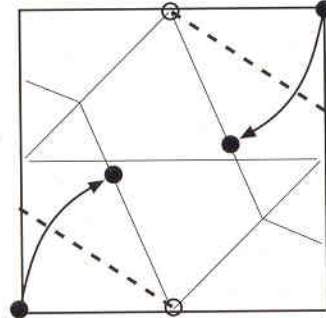
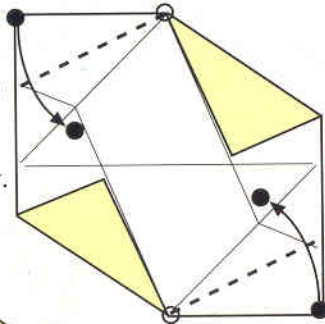

⑥ Bring the bottom edge to the crease and fold. Do the same on the top edge.

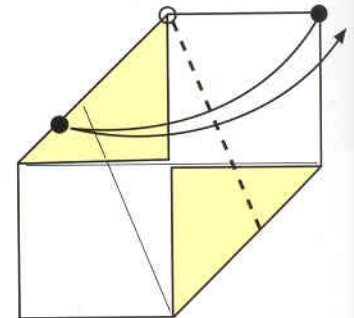

⑤ Bring the top edge to the left slanted edge and fold. Then unfold back to a square.

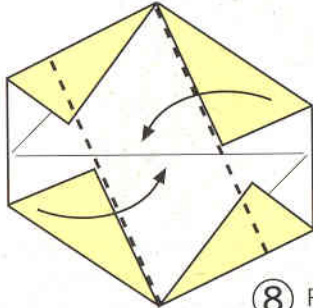

⑧ Fold along the two crease lines.

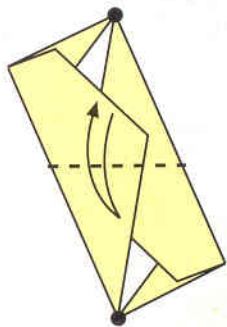

⑨ Fold by bringing the two points together and unfold.

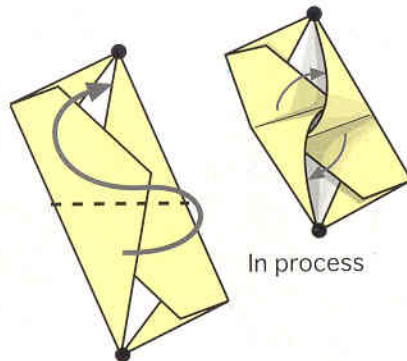

⑩ Fold in half and interlock the flaps.

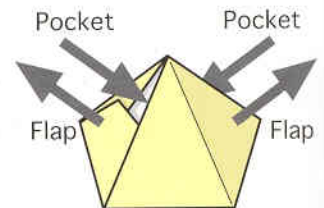

⑫ This is the Dodecahedral Skeleton Module. You need 30 modules.

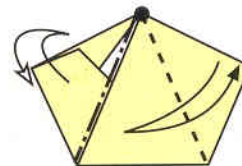

⑪ Fold and unfold.

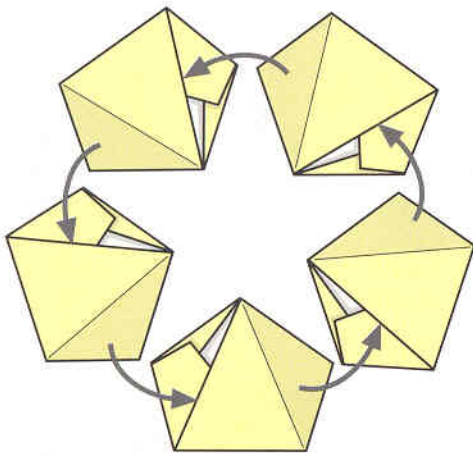
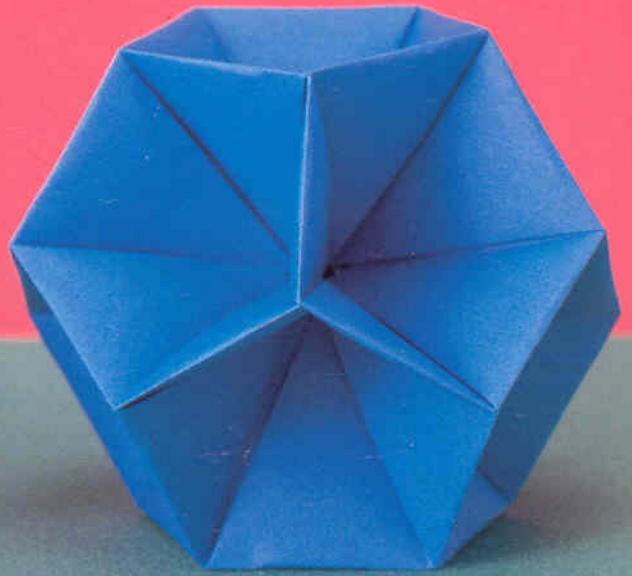
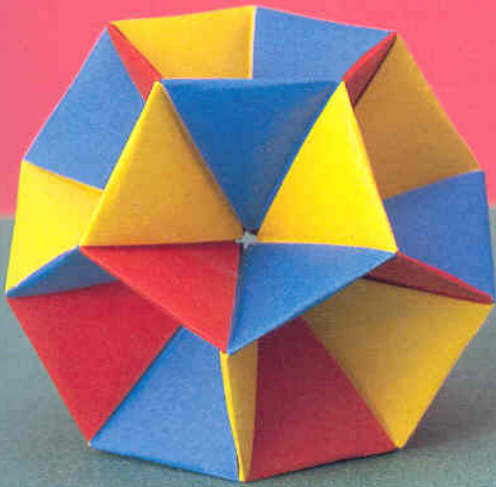

- 13 Insert the flaps into the pockets all around and make a dish shape.

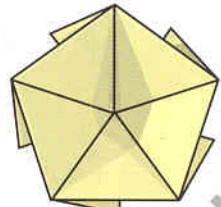

14

Turn the model over

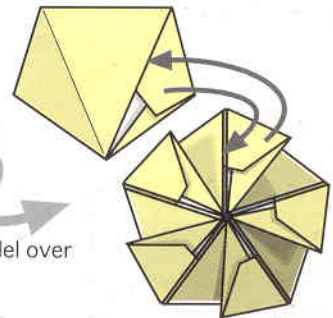

- 15 Insert the flap on the new piece into the pocket on the dish shape. Then insert the flap on the dish shape into the pocket on the new piece.

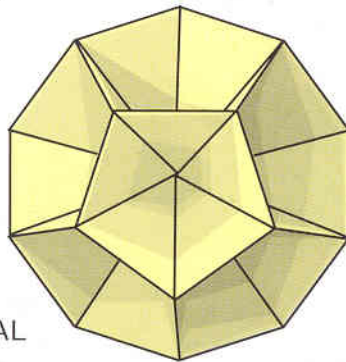

The completed
DODECAHEDRAL
SKELETON



This corner is formed by 3 modules.

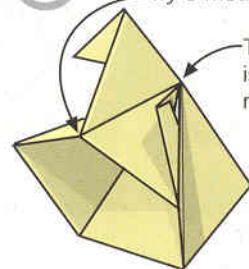

This interior corner is formed by 5 modules.

- 16 Insert the other modules the same way.

ICOSAHEDRAL SKELETON

せいじゅうめんたい すける とん
 正 20 面体のスケルトン
 SEI - JUUJU - MEN - TAI NO SU - KE - RU - TO - N

You need 30 square pieces of paper, all the same size.

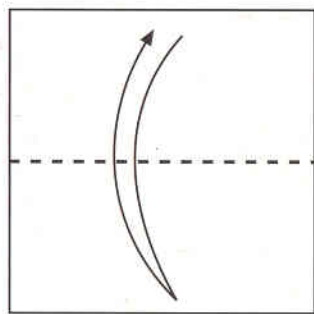

① Fold in half and unfold.

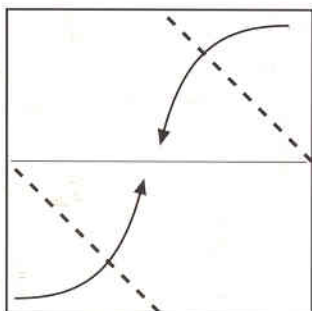

② Bring the lower right edge to the center line and fold. Do the same on the upper side.

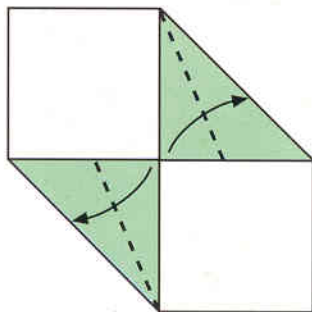

③ Bring the right edge of the lower triangle to the left edge and fold. Do the same on the upper side.

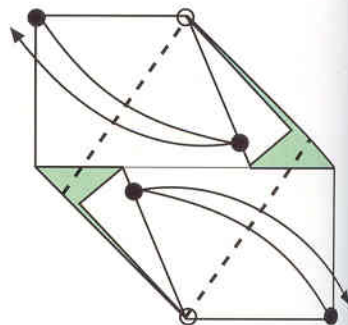

④ Bring the bottom edge to the left inside edge and fold. Do the same on the top edge and then unfold back to a square.

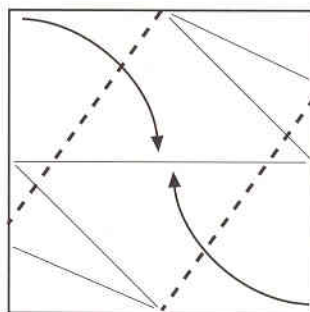
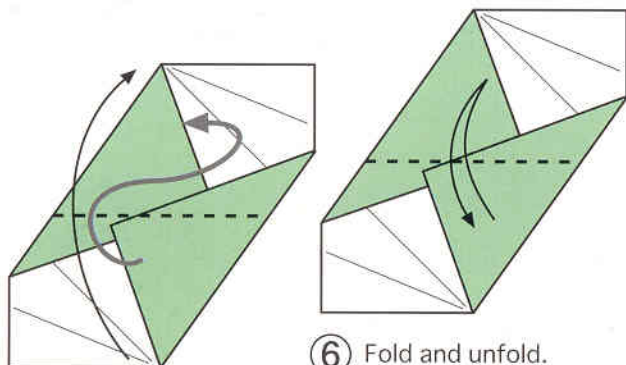

⑥ Fold and unfold.

⑤ Fold along the two crease lines.

⑦ Fold in half and interlock the flaps.

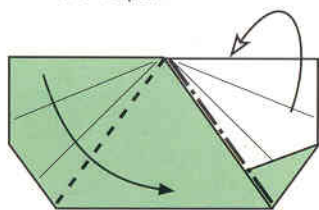

⑧ Fold along the edges.



⑨ Fold a little above the bottom edge. Do the same on the reverse side.

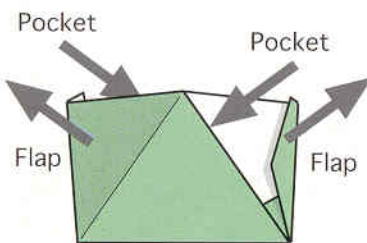

⑩ This is the Icosahedral Skeleton Module. You need 30 modules.

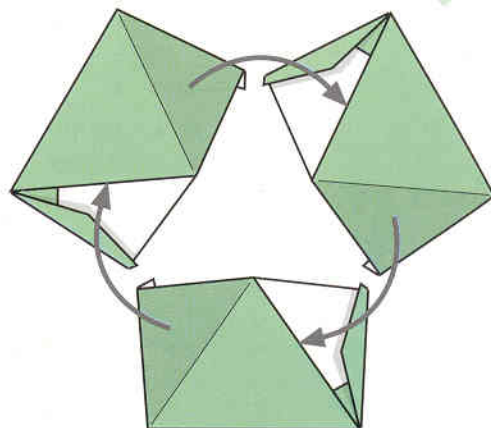

⑪ Insert the flaps into the pockets all around and make a dish shape.

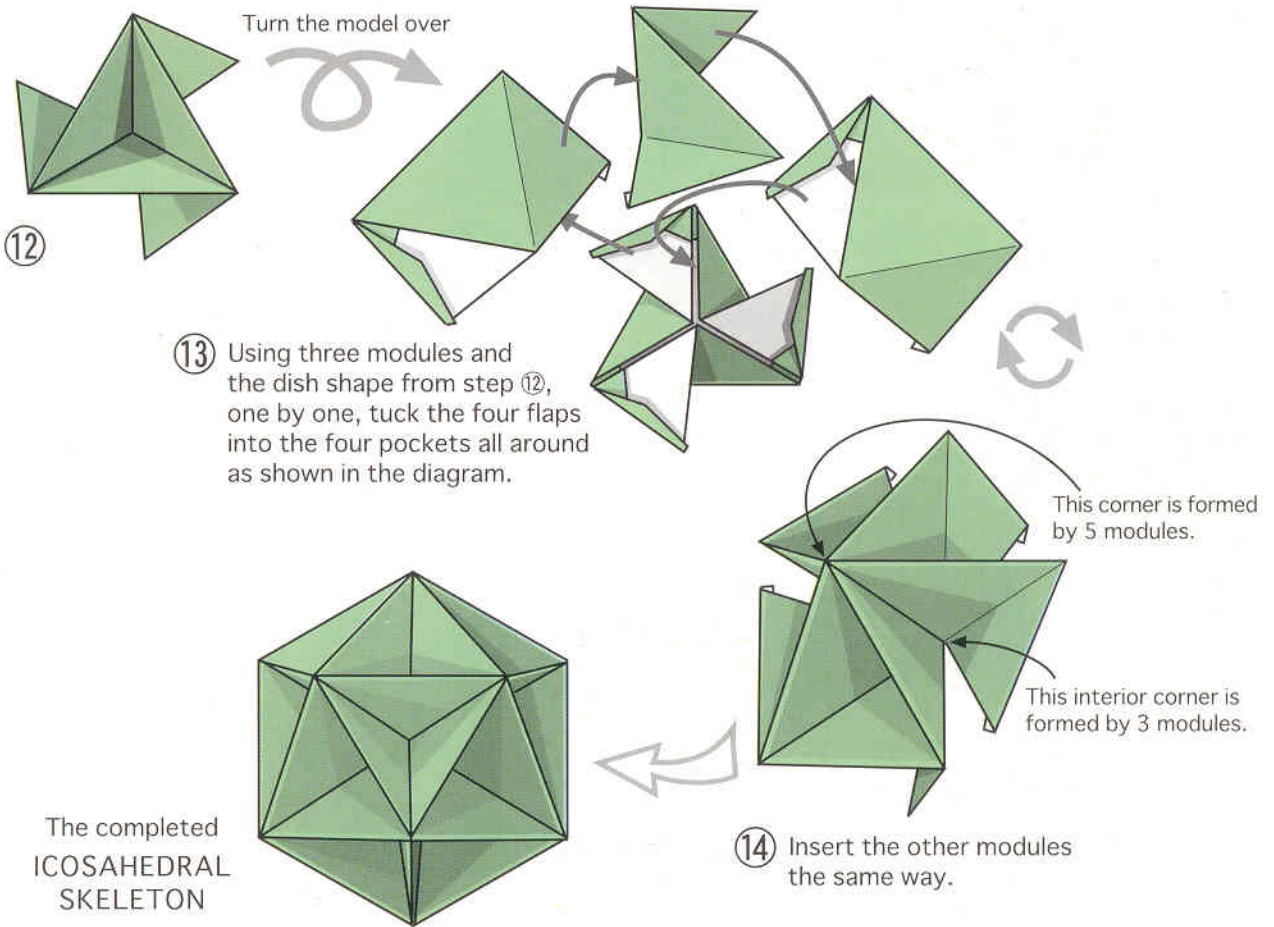
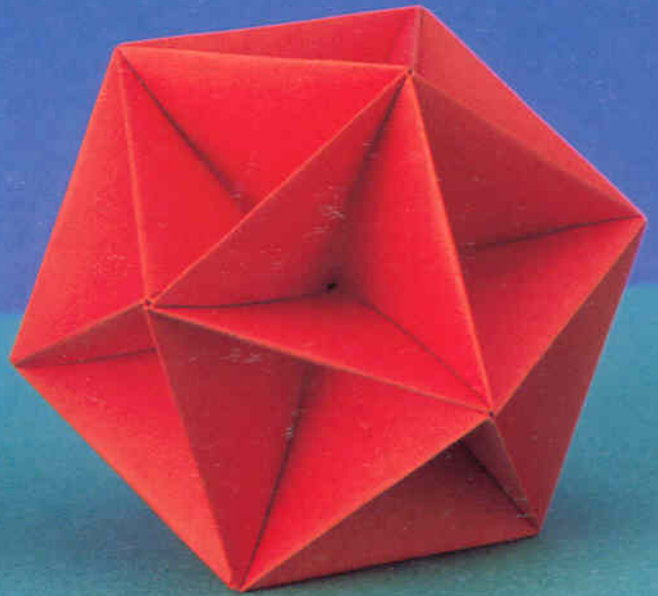
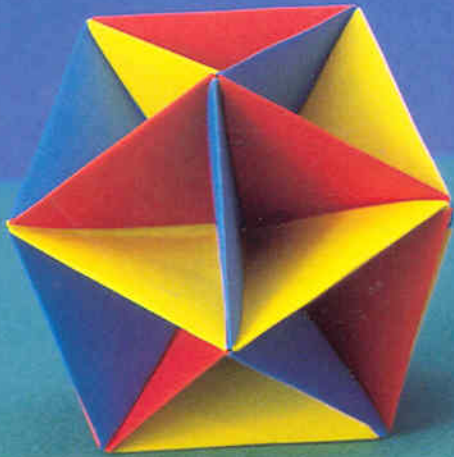

POLYHEDRAL FRAMES

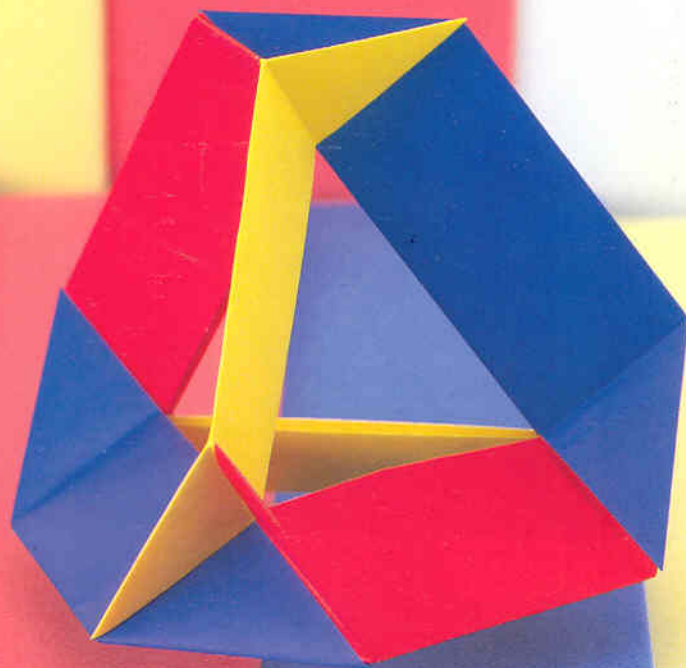

TRUNCATED TETRAHEDRAL FRAME

しめんたい ふれーむ
4面体のフレーム
SHI-MEN-TAI NO FU-RE-E-MU

You need 6 square pieces of paper, all the same size.

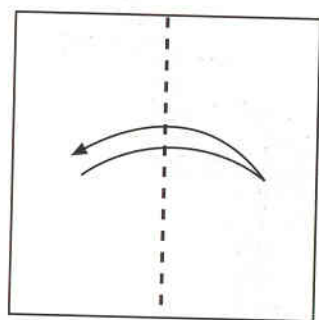

① Fold in half and unfold.

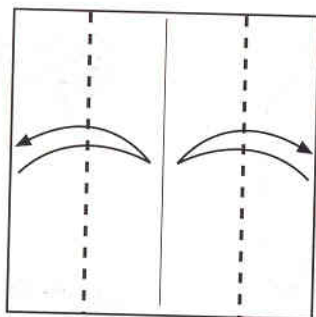

② Fold by bringing the right edge to the center line and unfold. Do the same on the left side.

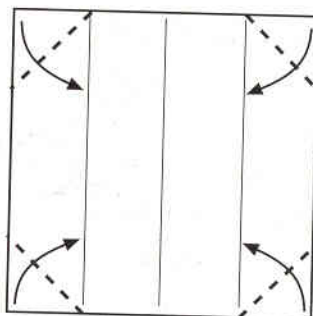

③ Fold the four corners.

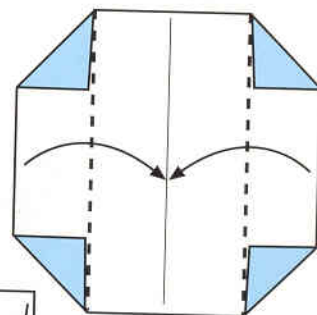

④ Fold along the two crease lines.



⑥ Fold and unfold.

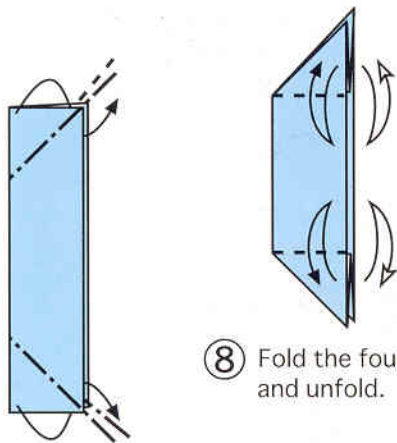

⑦ Push the two corners inside. (Inside Reverse Fold)

⑧ Fold the four flaps and unfold.

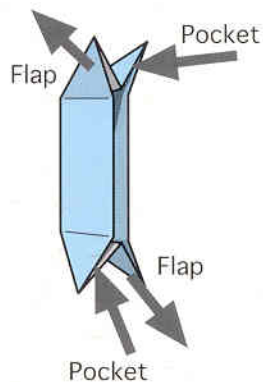

⑨ This is the Truncated Tetrahedral Frame Module. You need 6 modules.



⑤ Fold in half.

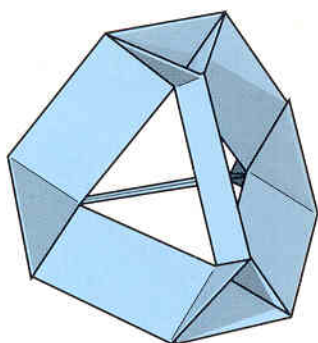

The completed TRUNCATED TETRAHEDRAL FRAME

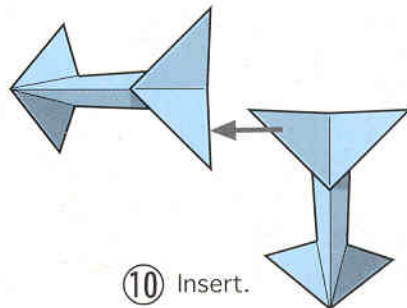

⑩ Insert.

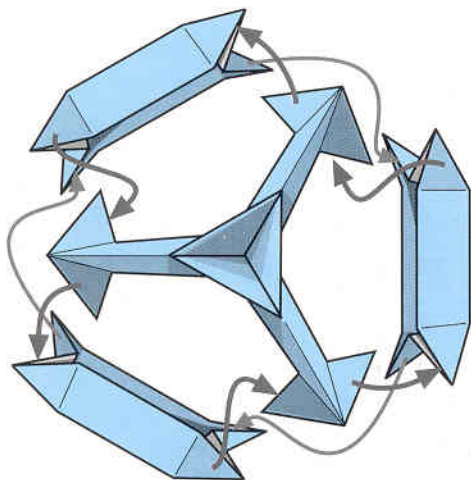

⑫ Put together the other three modules as shown in the diagram.

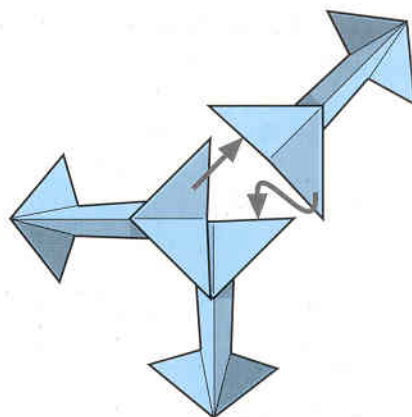

⑪ Insert the two flaps into the two pockets and make a dish shape on the top of the model.

OCTAHEDRAL FRAME

せい はちめんたい ふれーむ
正 8 面 体 の フ レーム
SEI-HACHI-MEN-TAI NO FU-RE-E-MU

You need 6 square pieces of paper, all the same size.

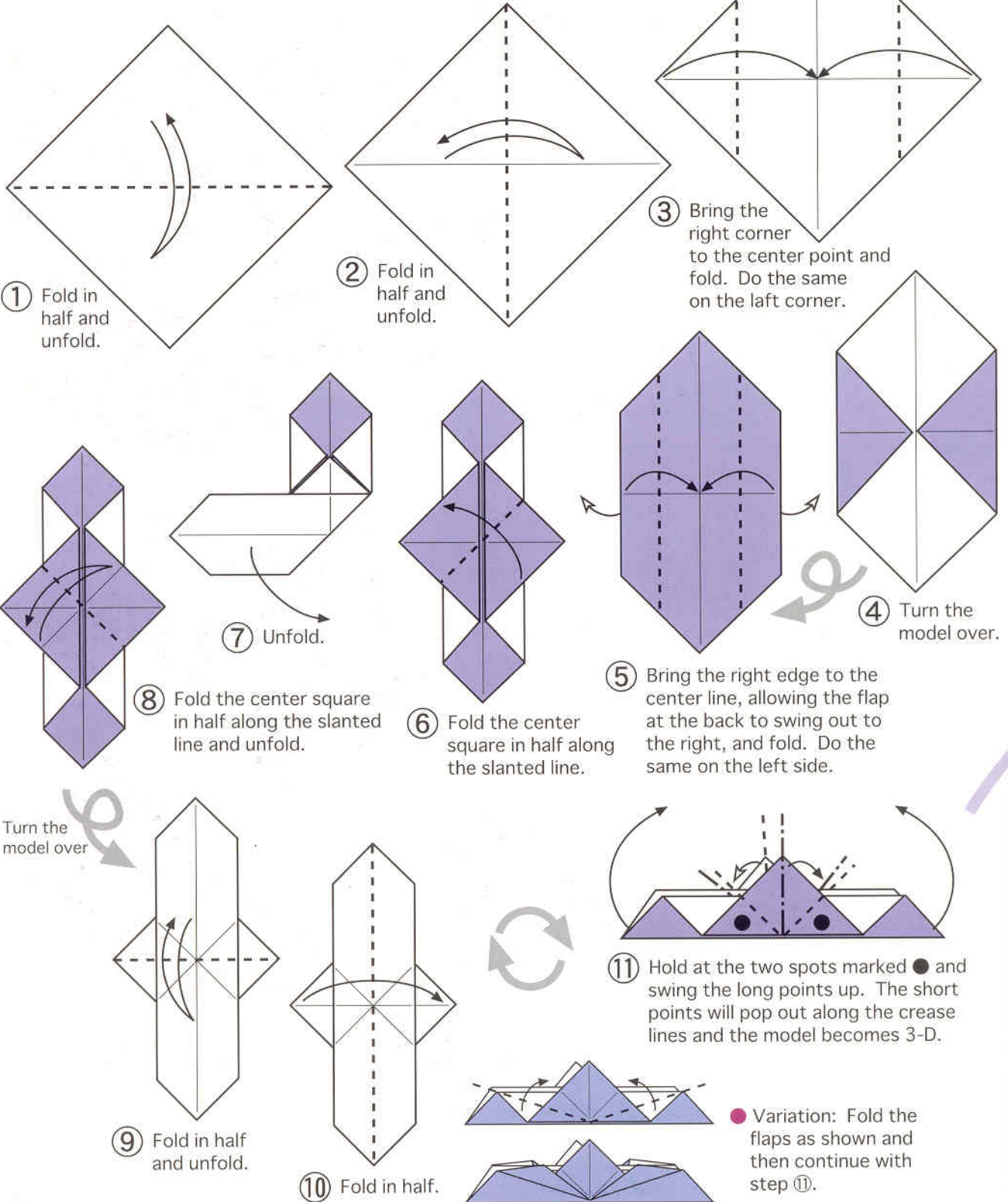

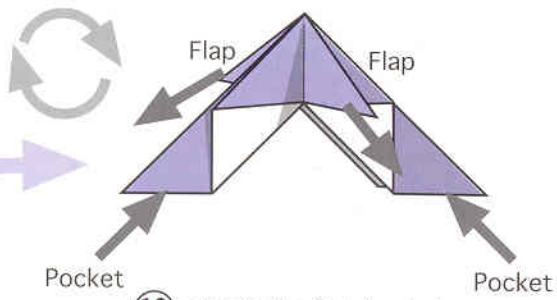
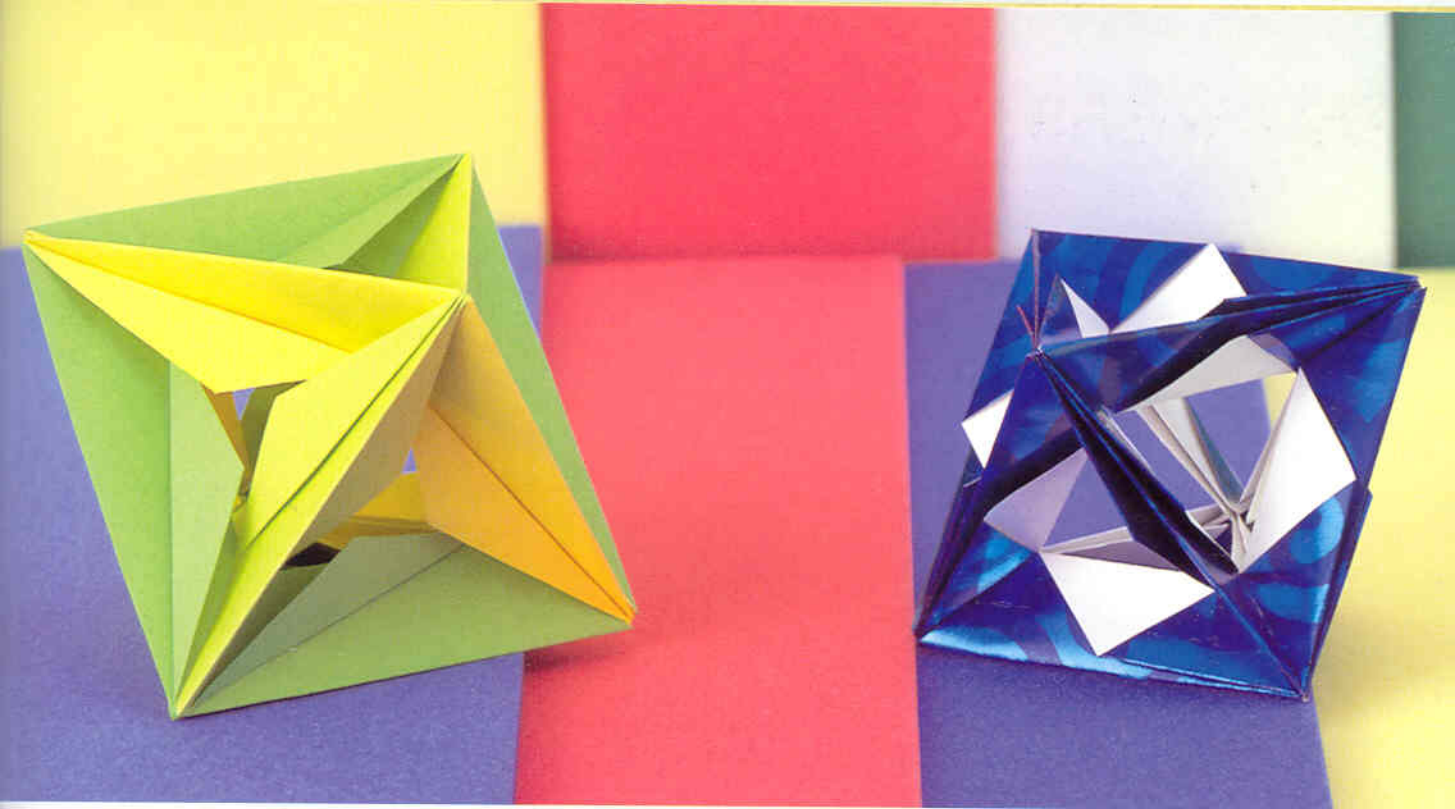

⑫ This is the Octahedral Frame Module. You need 6 modules.

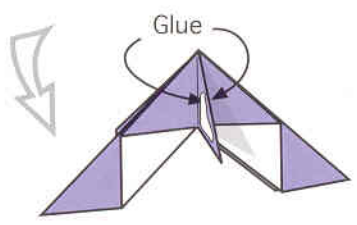

⑬ Put glue on the two faces of a flap.

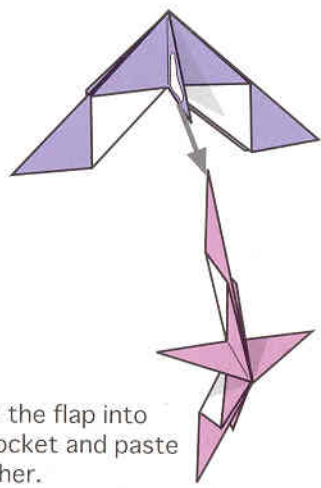

⑭ Insert the flap into the pocket and paste together.

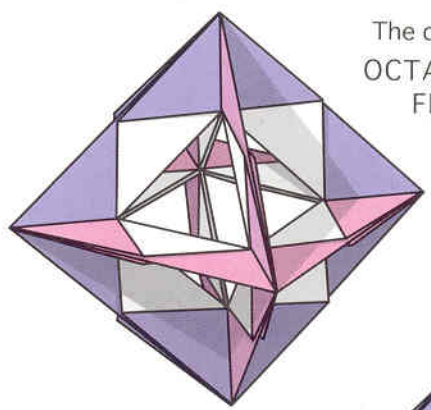

The completed OCTAHEDRAL FRAME

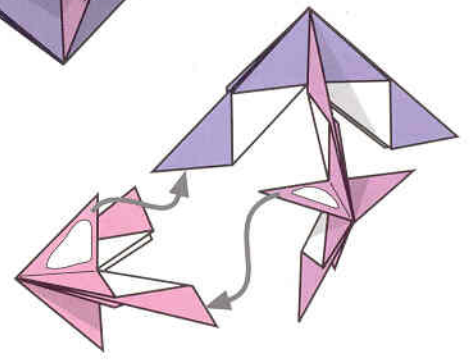

⑮ Assemble and glue together the other modules the same way.

POLYHEDRA KIT

OCTAHEDRON

● Diagram: Page 66

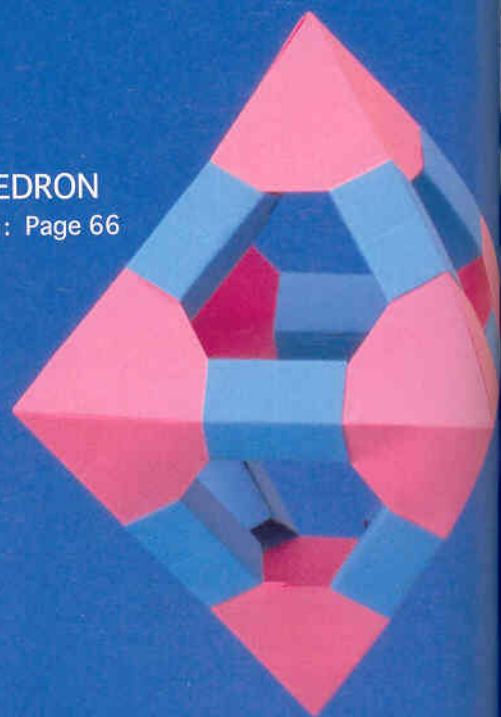

ICOSAHEDRON

● Diagram: Page 70

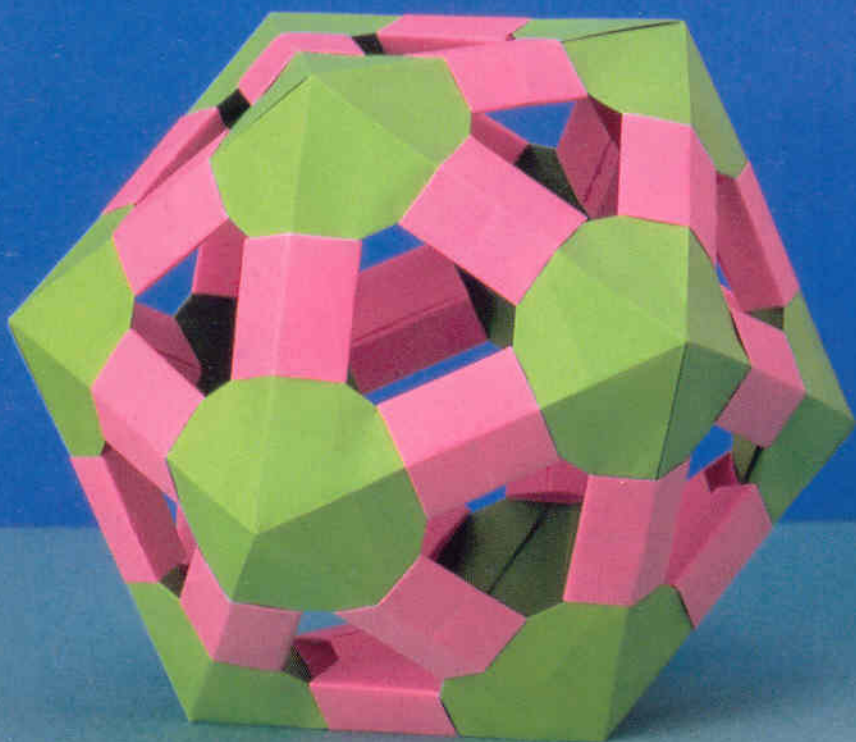

CUBE

● Diagram: Page 63

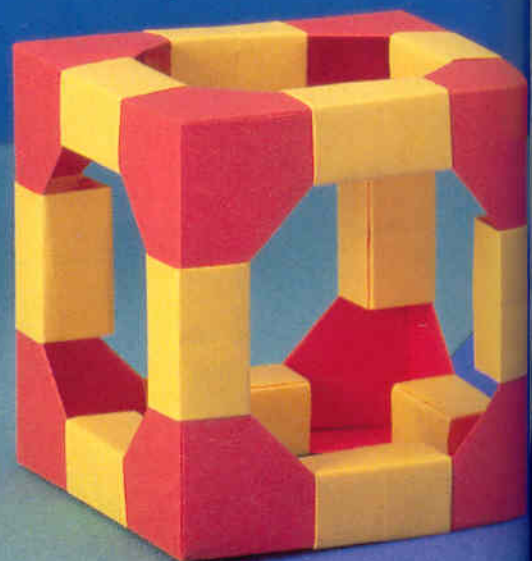

DODECAHEDRON

● Diagram: Page 68

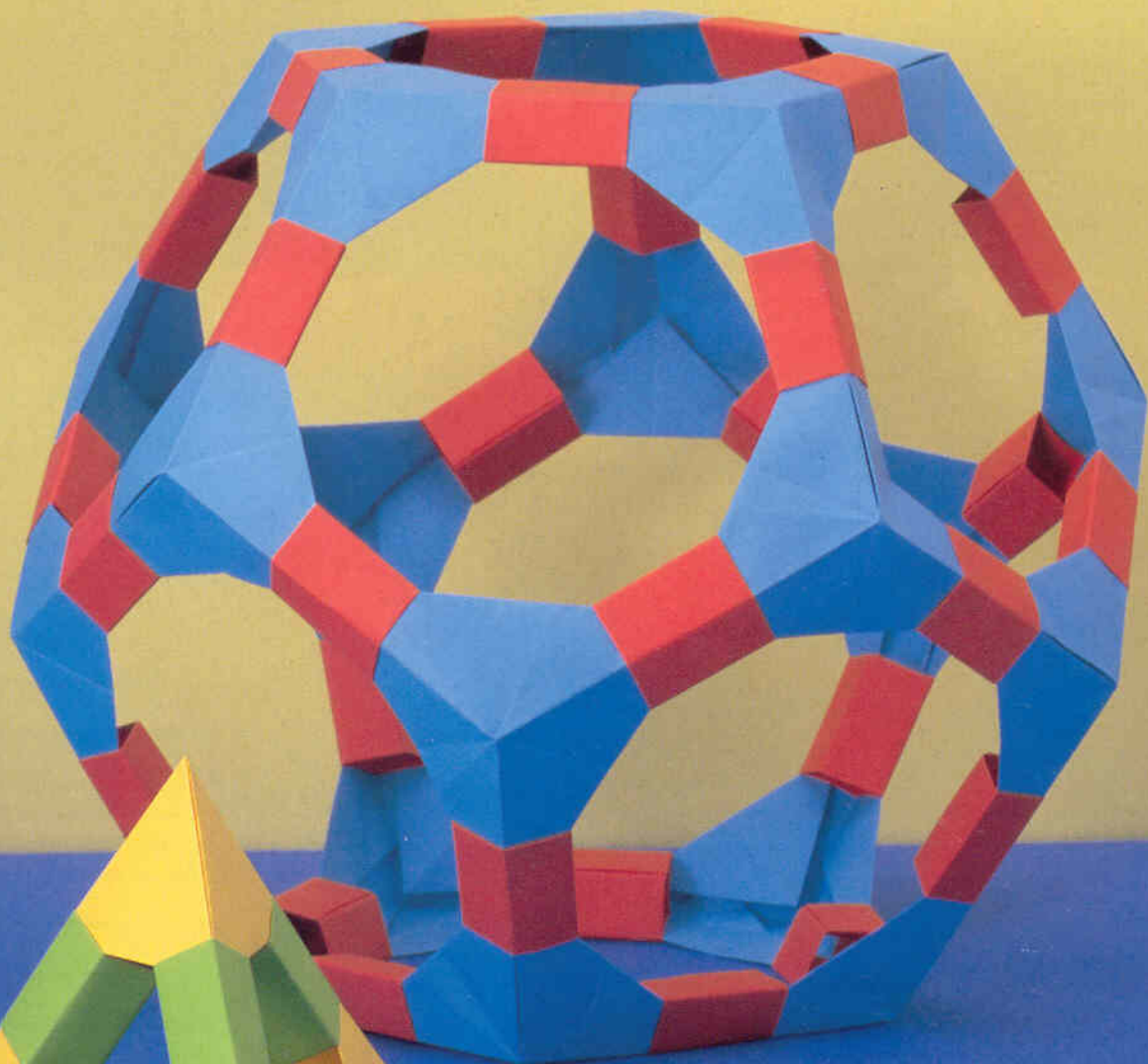

TETRAHEDRON

● Diagram: Page 64

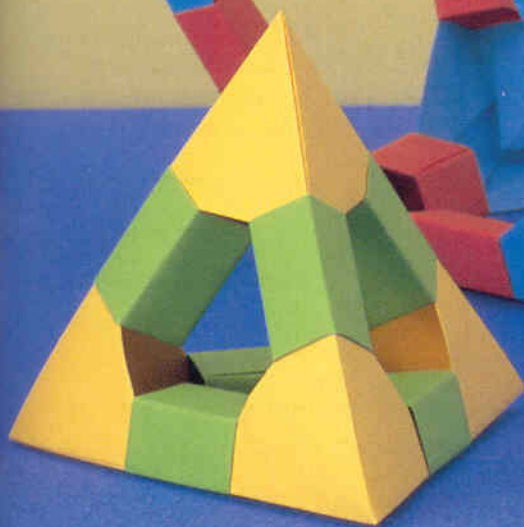

POLYHEDRA KIT: EDGE MODULE

ためんたいき っ と へん ぶひん
多面体キット: 辺の部品
TA-MEN-TAI KIT - TO HEN NO BU-HIN

Start with a square piece of paper.

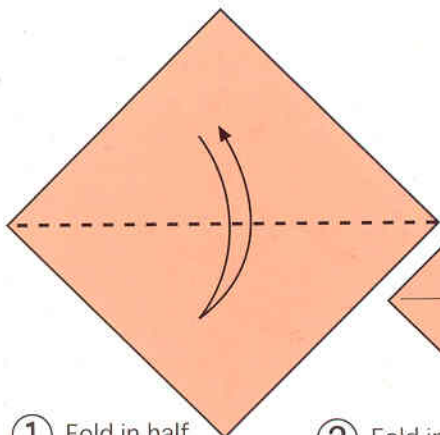

① Fold in half and unfold.

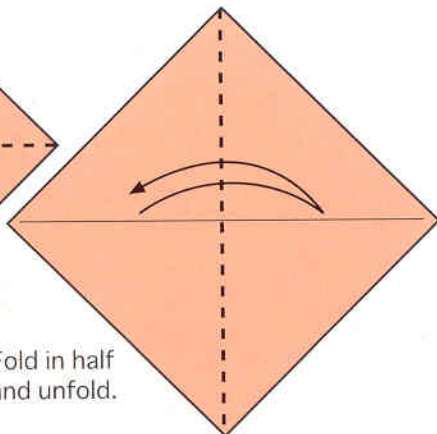

② Fold in half and unfold.

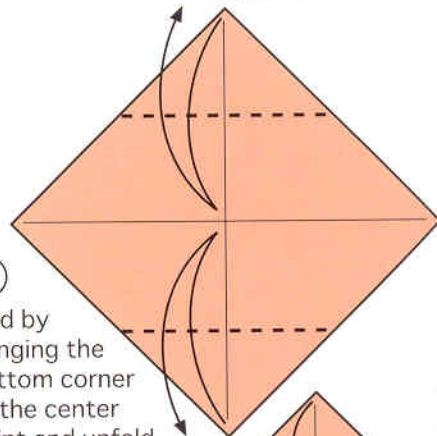

③ Fold by bringing the bottom corner to the center point and unfold. Do the same on the top corner.

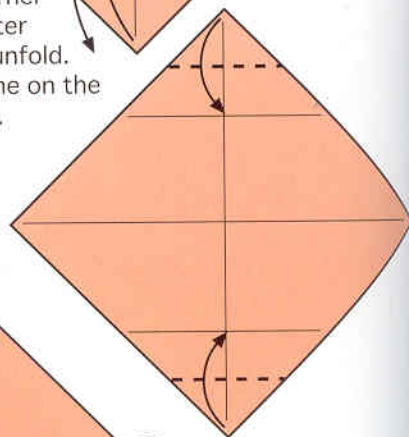

④ Bring the bottom corner to the intersection of the center line and the quarter line and fold. Do the same on the top corner.

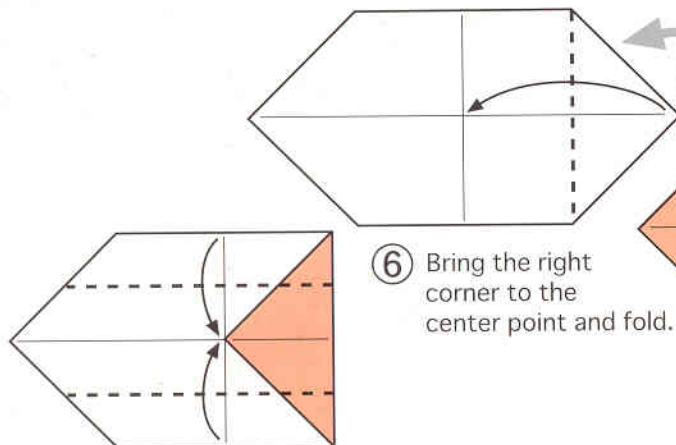

Turn the model over

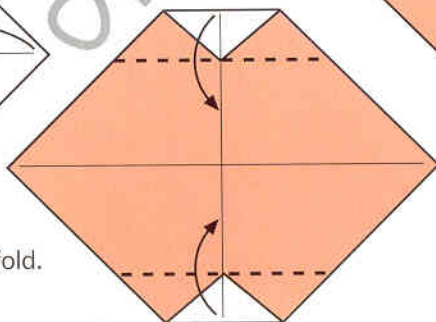

⑤ Fold along the two crease lines.

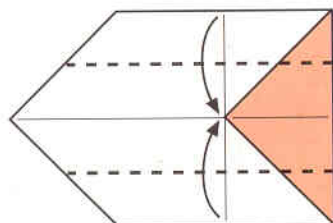

⑦ Bring the bottom edge to the center line and fold. Do the same on the top edge.

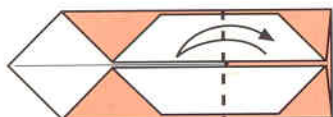

⑧ Fold and unfold.

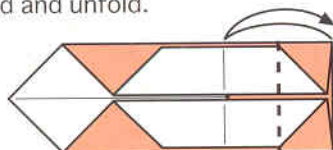

⑨ Fold and unfold.

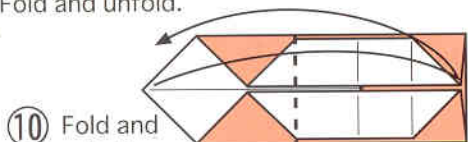

⑩ Fold and unfold.

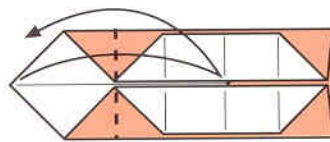

⑪ Fold and unfold.

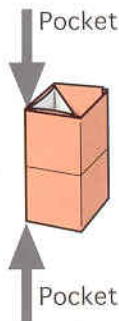

The completed Edge Module

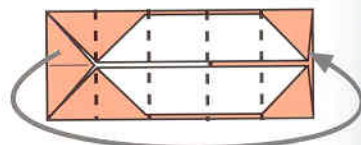

⑬ Tuck the flap into the pocket at the other end.

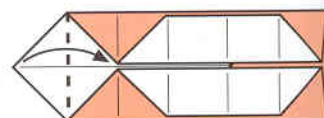

⑫ Fold the left corner.

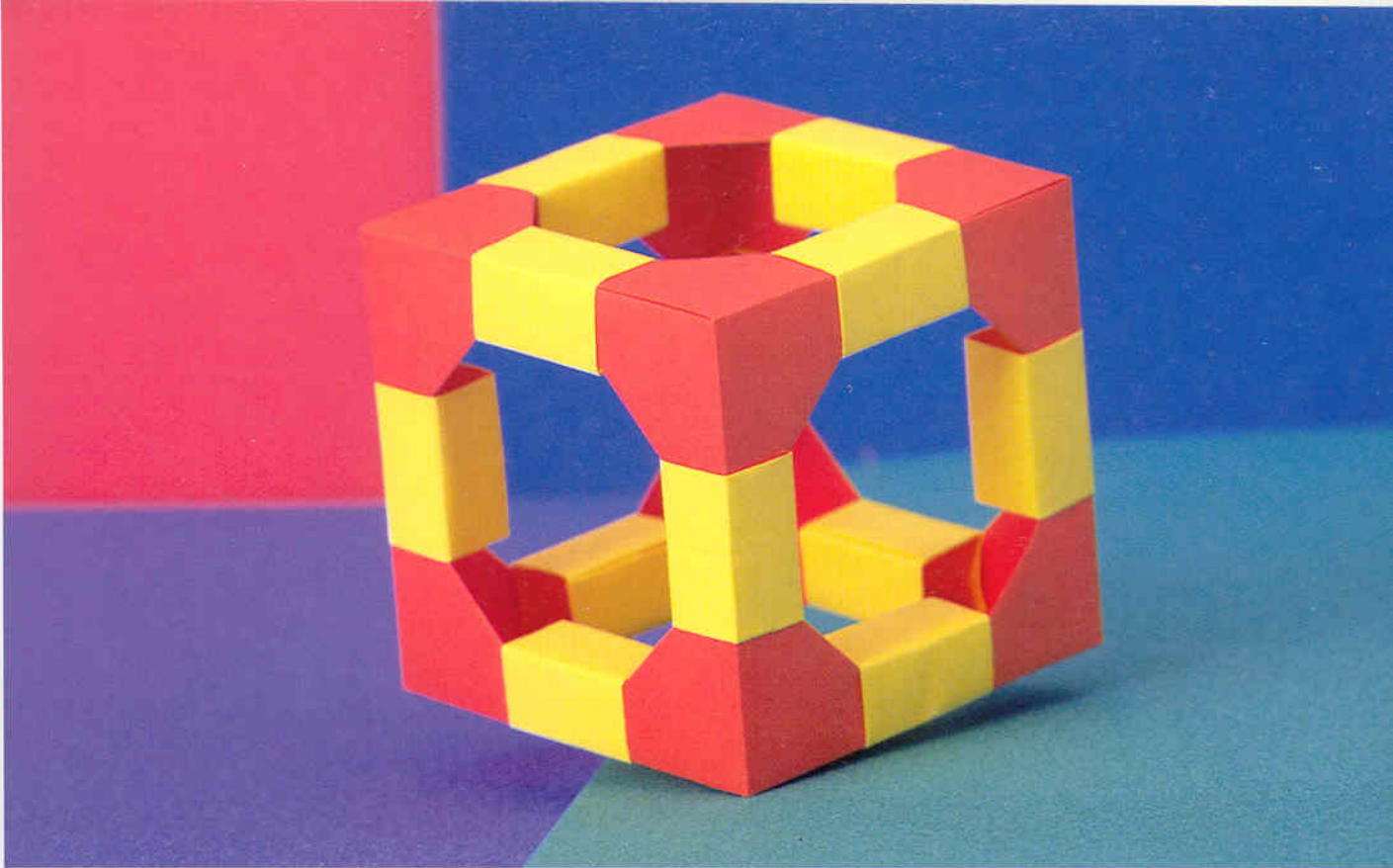

POLYHEDRA KIT: CUBE

リッポウたい
立方体
RIP - POU - TAI

You need 8 RIGHT CORNER 2 units on page 14
and 12 Edge Modules on page 62.
(So you need 20 square pieces of paper, all the same size.)

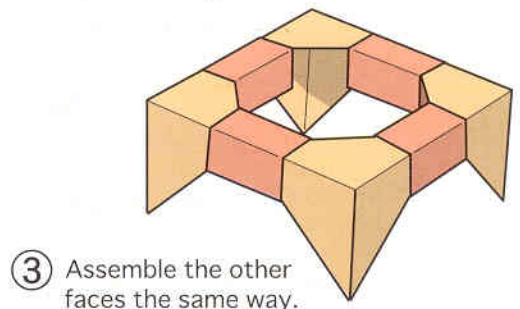
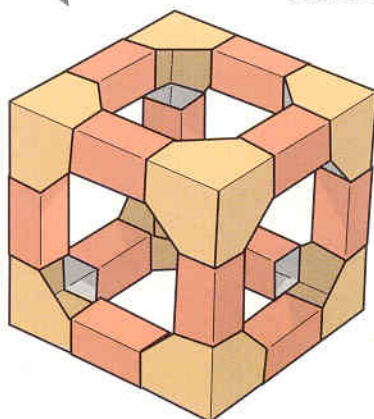
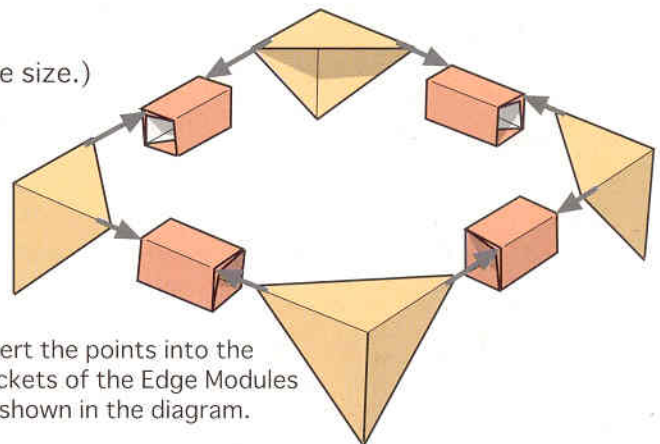
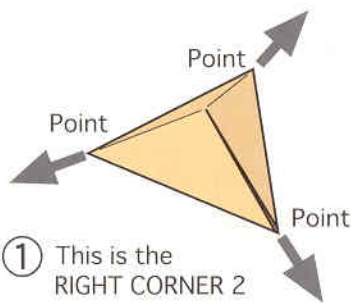

POLYHEDRA KIT: TETRAHEDRON

せいしめんたい
正四面体
SEI-SHI-MEN-TAI

You need 10 of the same size, square pieces of paper.

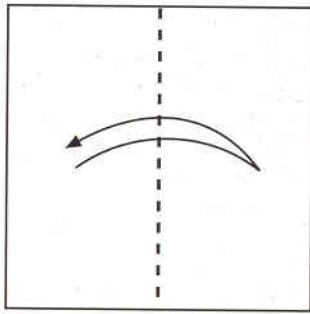

① Fold in half and unfold.

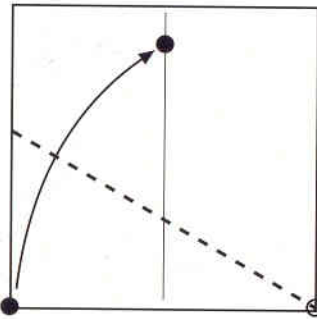

② Bring the lower left corner to the center line and fold. Make sure the fold goes through the lower right corner.

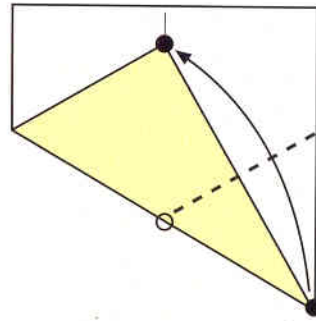

③ Bring the two points marked ● together and fold.

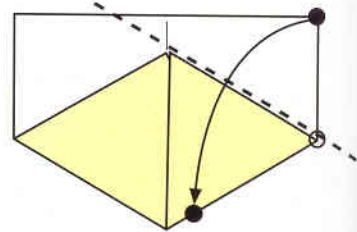

④ Fold along the edge.

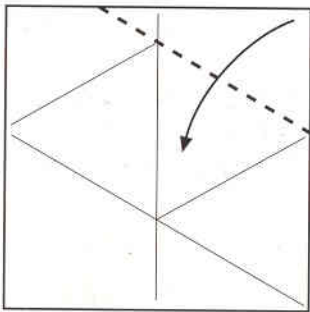

⑦ Fold along the existing crease line.

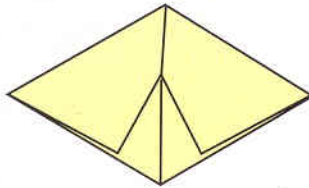

⑥ Unfold back to a square.

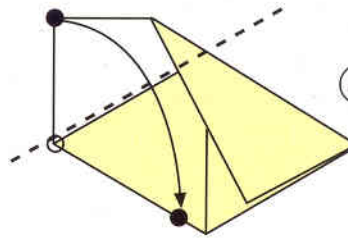

⑤ Fold along the edge.

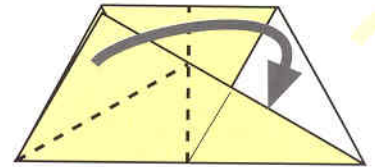

⑫ Fold in half and tuck the flap under the top layer.

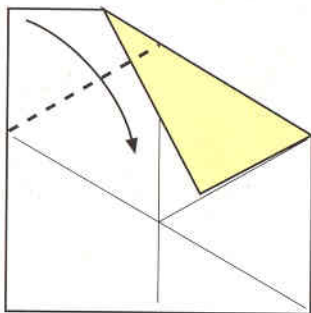

⑧ Fold along the existing crease line.

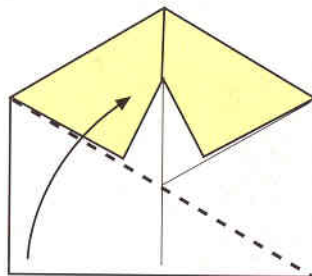

⑨ Fold along the existing crease line.

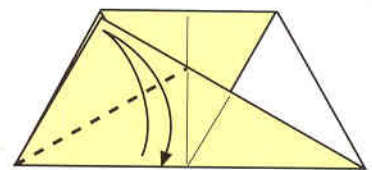

⑪ Fold the left edge of the top layer down to the bottom edge and unfold.

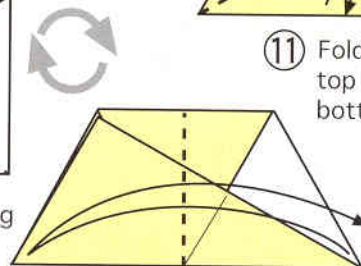

⑩ Fold in half and unfold.

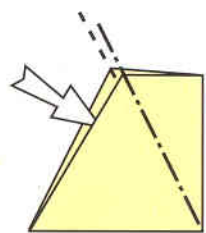
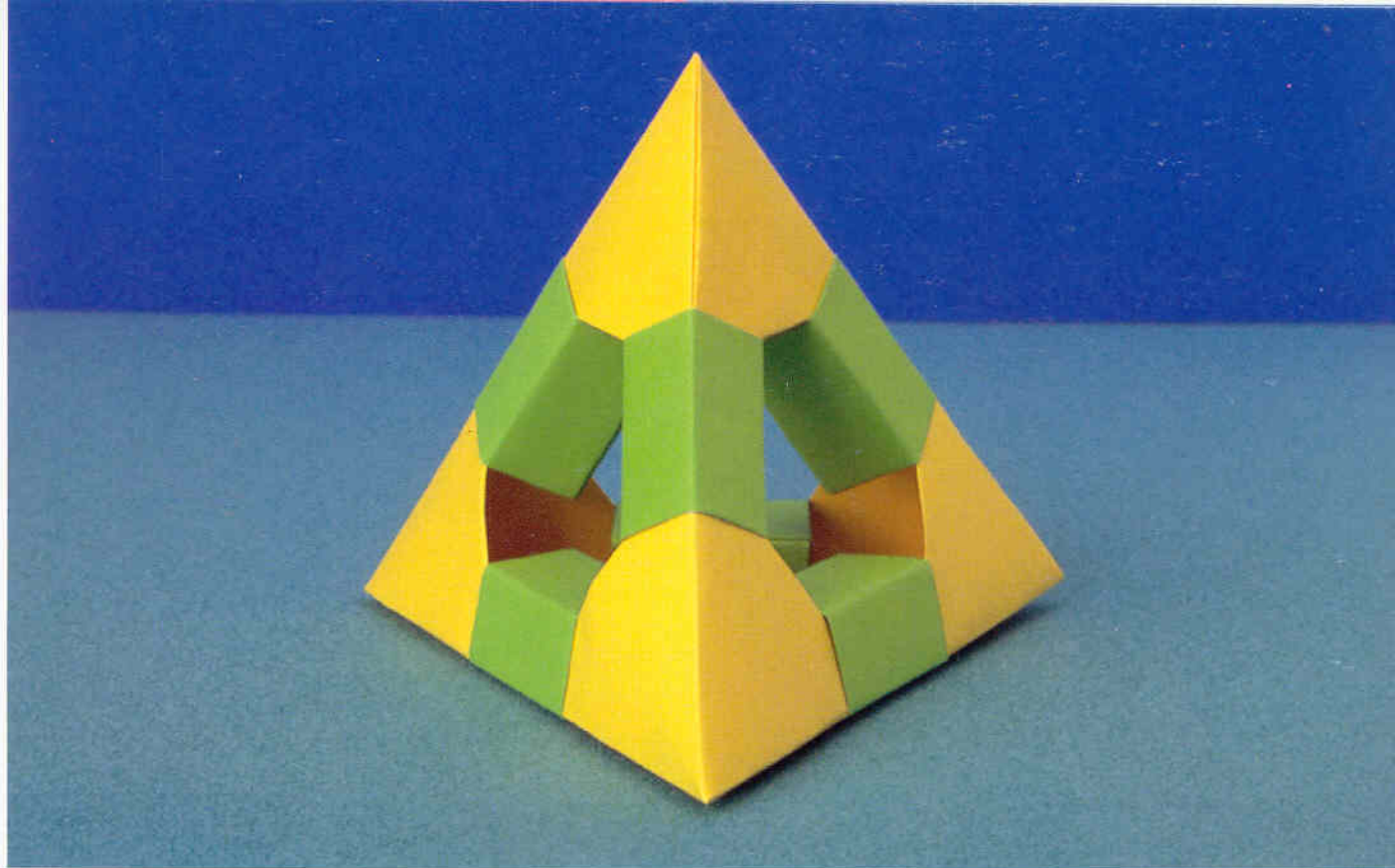

- 13 Spread the inside open and make a mountain shape.

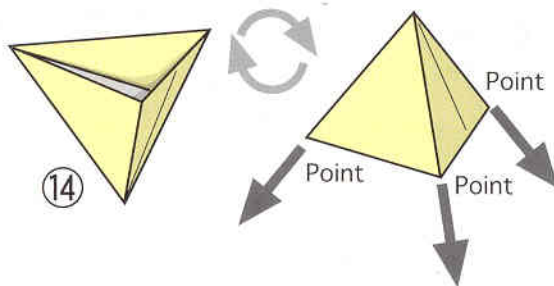

14

- 15 This is the Tetrahedron Vertex Module.

You need 4 Tetrahedron Vertex Modules and 6 Edge Modules on page 62.

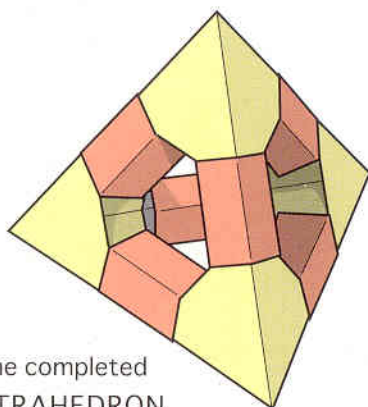

The completed TETRAHEDRON

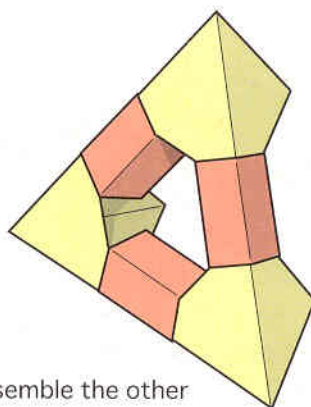

- 16 Insert the points into the pockets of the Edge Modules as shown in the diagram.

- 17 Assemble the other faces the same way.

POLYHEDRA KIT: OCTAHEDRON

せい はち めん たい
正 8 面 体
SEI-HACHI-MEN-TAI

You need 18 square pieces of paper, all the same size.

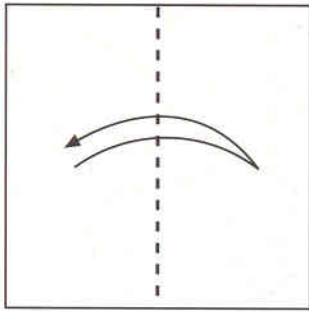

① Fold in half and unfold.

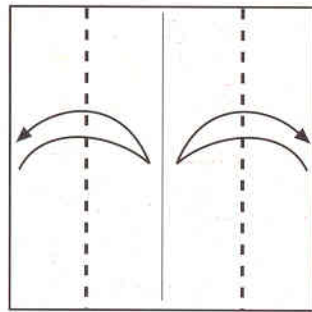

② Fold by bringing the right edge to the center line and unfold. Do the same on the left side.

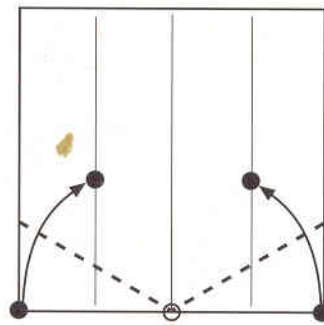

③ bring the lower left corner to the quarter line and fold as shown in the diagram. Do the same on the right corner.

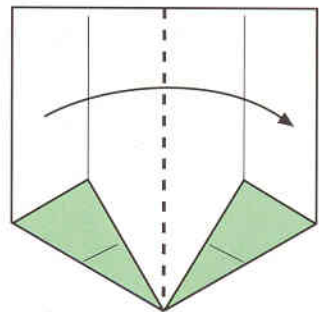

④ Fold in half.

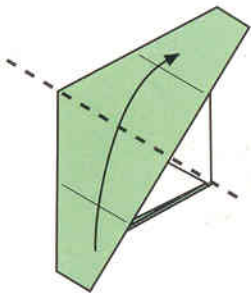

⑥ Spread open from the inside and squash flat.

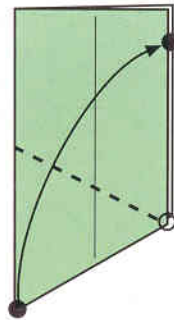

⑤ Bring the bottom edge to the right edge and fold.

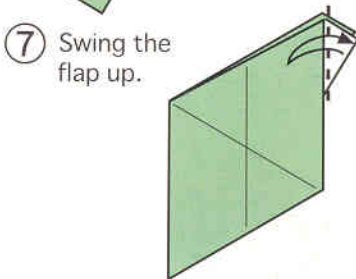

⑦ Swing the flap up.

⑧ Fold the two flaps along the edge line and unfold.

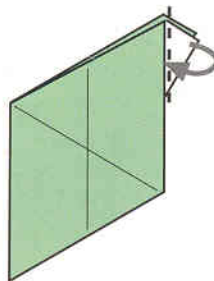

⑨ Tuck the two flaps inside, under the top layer.

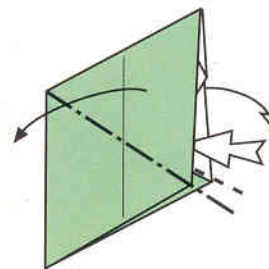

⑩ Spread open from the inside and squash flat.

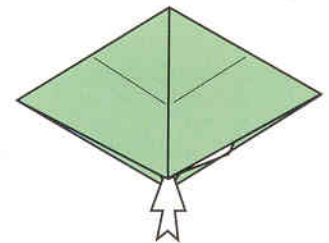

⑪ Spread the inside open and make a mountain shape.

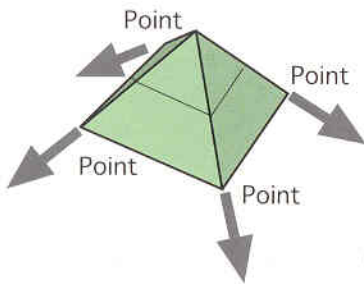
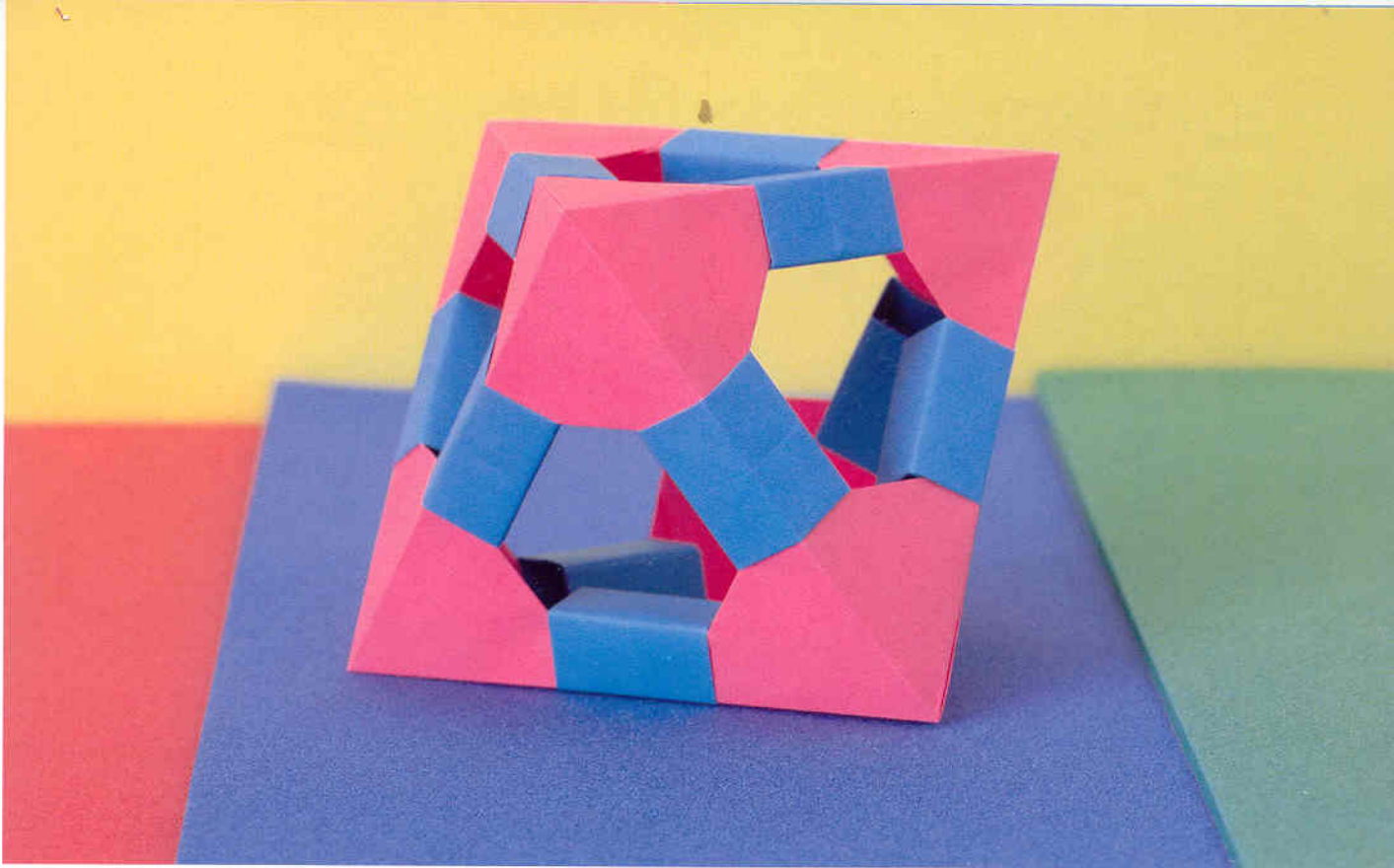

⑫ This is the Octahedron Vertex Module.

You need 6 Octahedron Vertex Modules and 12 Edge Modules on page 62.

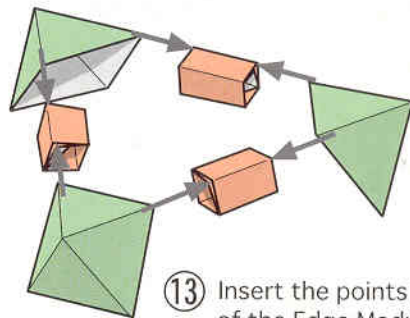

⑬ Insert the points into the pockets of the Edge Modules as shown in the diagram.

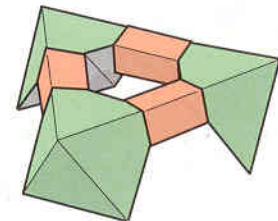
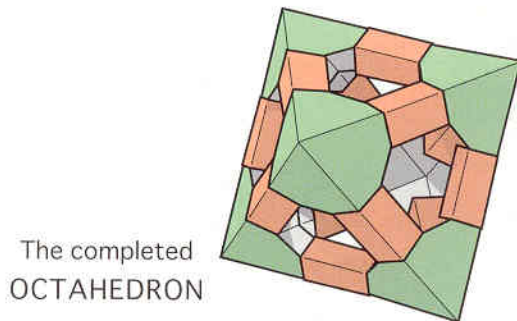

⑭ Assemble the other faces the same way.

POLYHEDRA KIT: DODECAHEDRON

せいじゅうにめんたい
正12面体
SEI - JUUNI - MEN - TAI

You need 50 square pieces of paper, all the same size.

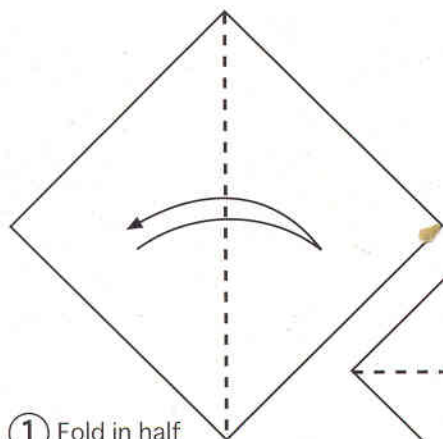

① Fold in half and unfold.

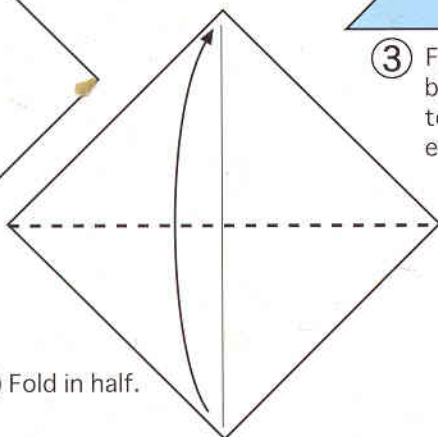

② Fold in half.

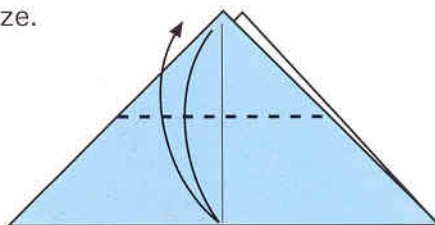

③ Fold only one layer down by bringing the top corner to the center of the bottom edge and unfold.

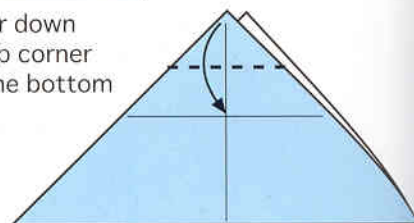

④ Fold only one layer down by bringing the top corner to the intersection of the center line and the quarter line.

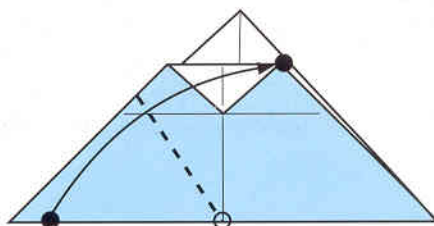
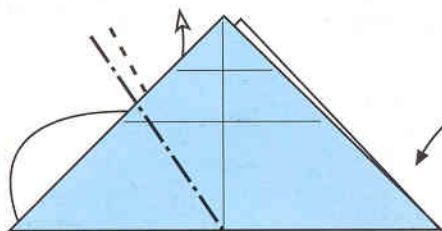

⑤ Fold by bringing the bottom edge to the right corner.

⑥ Unfold.

⑦ Push the point to the inside. (Inside Reverse Fold)

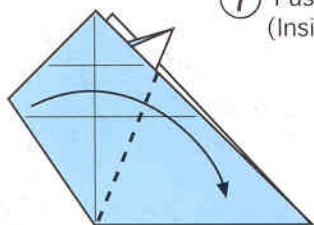

⑧ Fold the flap down.

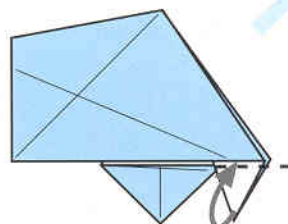
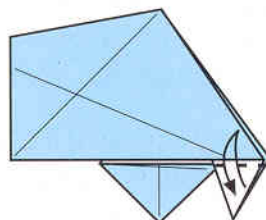

⑭ Tuck the flap inside, under the top layer.

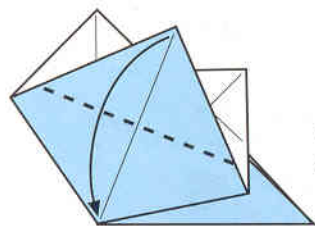

⑨ Fold only one layer.

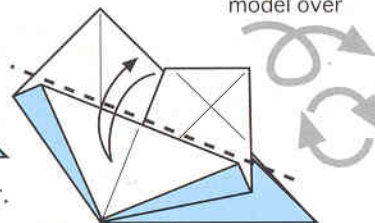

⑩ Fold all the layers along the edge line and unfold.

⑬ Fold and unfold.

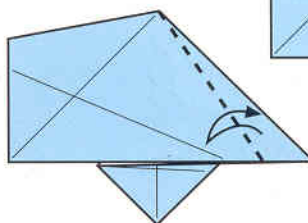

⑪ Fold along the edge of the reverse side and unfold.

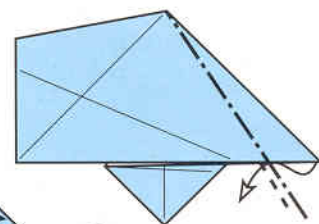

⑫ Push the point to the inside. (Inside Reverse Fold)

Turn the model over



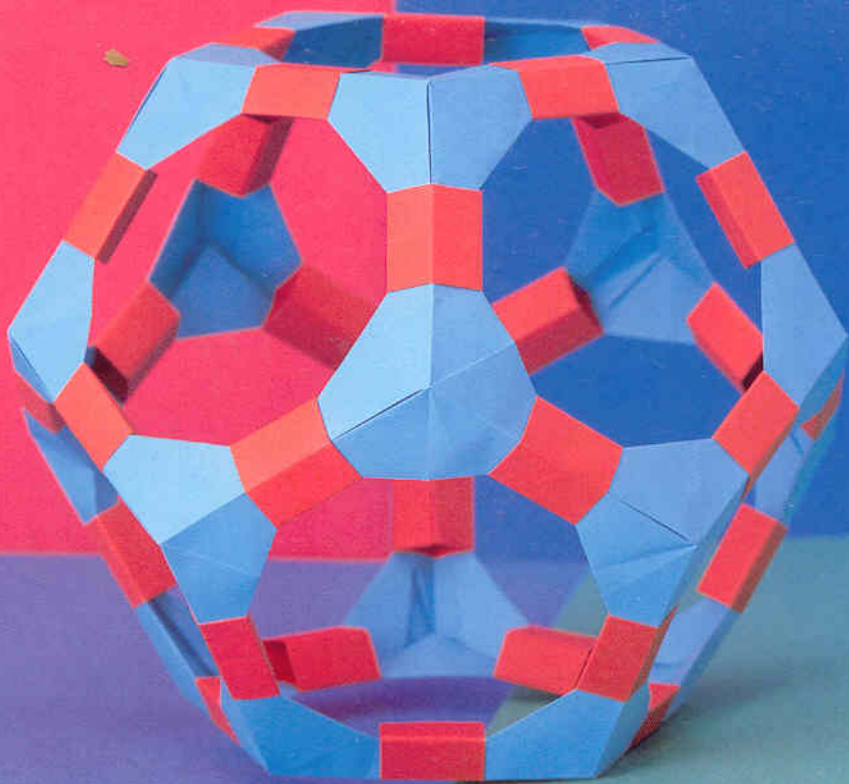

- 15 Spread the inside open and make a mountain shape.
- 16 Fold along the three crease lines.
- 17 Fold a bit of the top corner down. Fold and unfold the tips of the side flaps so the flaps lie flush with the inside.
- 18 This is the Dodecahedron Vertex Module.
- Turn the model over

You need 20 Dodecahedron Vertex Modules and 30 Edge Modules on page 62.

- 19 Insert the points into the pockets of the Edge Modules as shown in the diagram.
- 20 Assemble the other faces the same way.
- The completed DODECAHEDRON

POLYHEDRA KIT: ICOSAHEDRON

せい にじゅうめん たい
正 20 面体
SEI - NIJUJU - MEN - TAI

You need 42 square pieces of paper, all the same size.

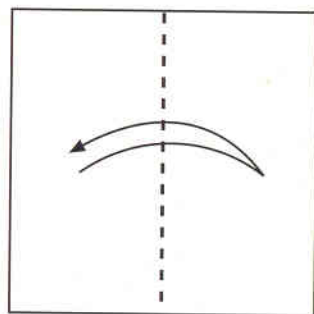

① Fold in half and unfold.

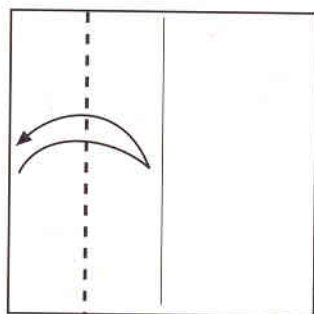

② Fold by bringing the left edge to the center line and unfold.

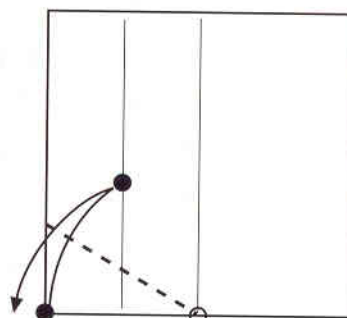

③ Fold by bringing the lower left corner to the quarter line and unfold as shown in the diagram.

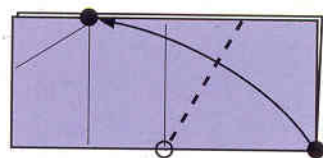

⑥ Bring the lower right corner to the top of the quarter line, marked ●, and fold.

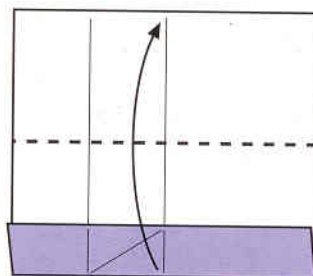

⑤ Fold the bottom edge up to the top.

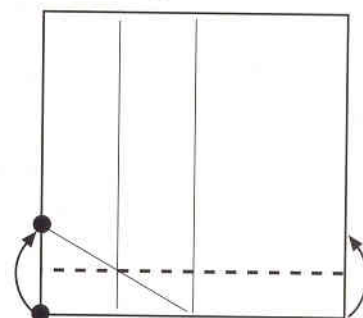

④ Bring the two points marked ● together and fold.

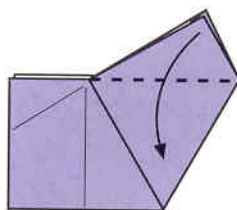

⑦ Fold both flaps down.

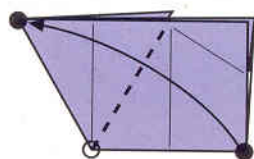

⑧ Bring the lower right corner to the left point and fold.

Turn the model over

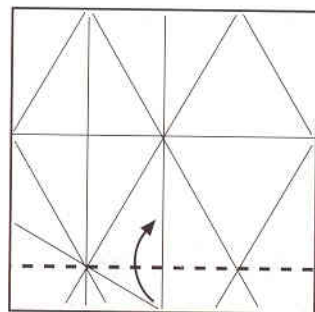

⑪ Fold along the crease line.

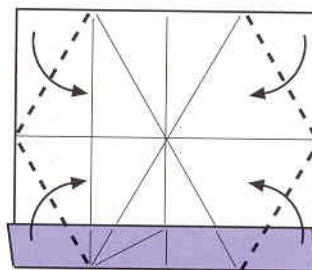

⑫ Fold along the four crease lines.

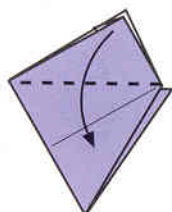

⑨ Fold both flaps down.

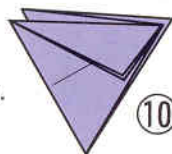

⑩ Unfold back to a square.

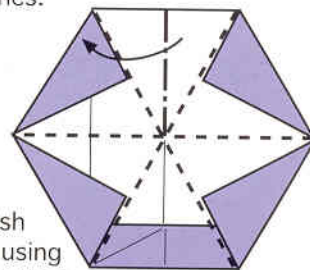

⑬ Make a dish shape by using the crease lines. The model becomes 3-D.

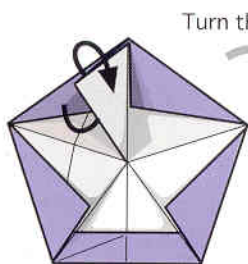
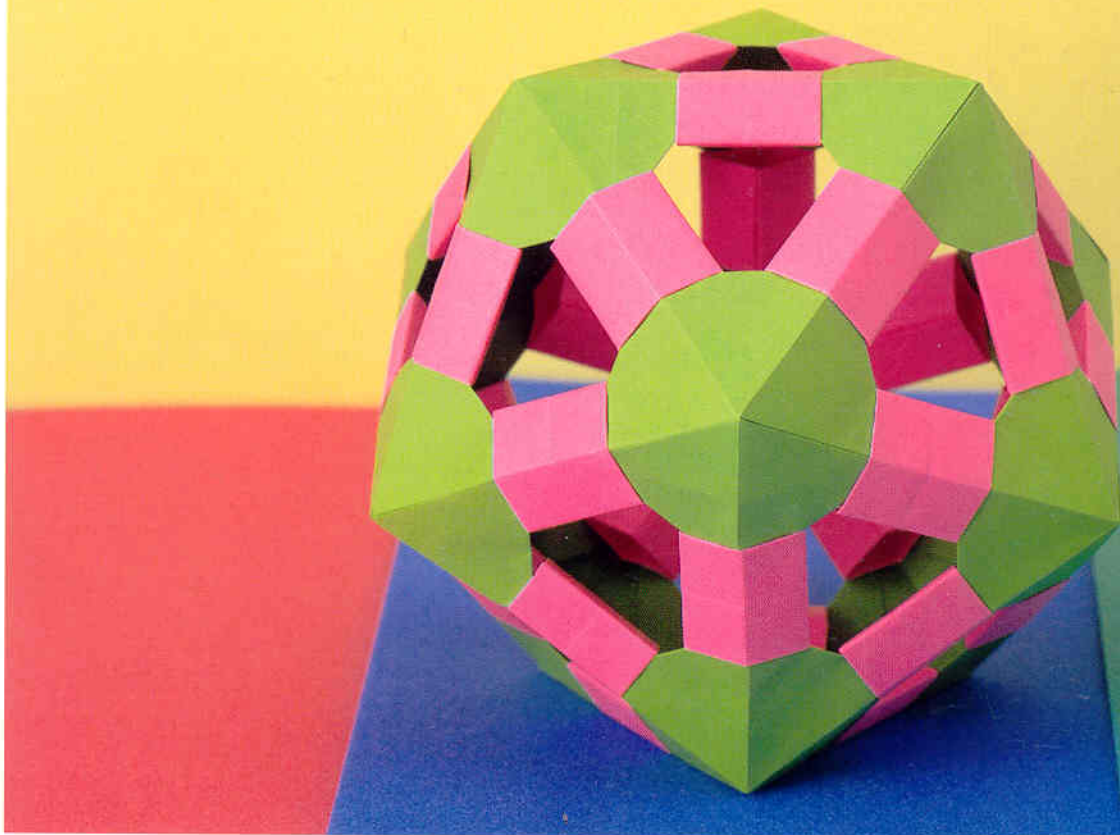

⑭ Tuck the flap under the layer.

Turn the model over

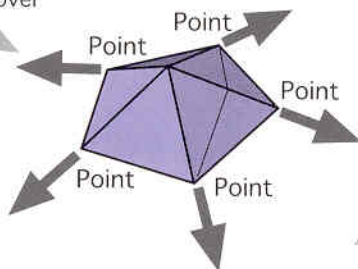

⑮ This is the Icosahedron Vertex Module.

You need 12 Icosahedron Vertex Modules and 30 Edge Modules on page 62.

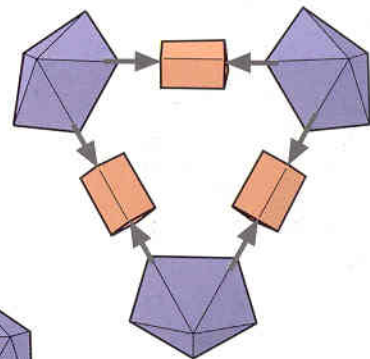

⑯ Insert the points into the pockets of the Edge Modules as shown in the diagram.

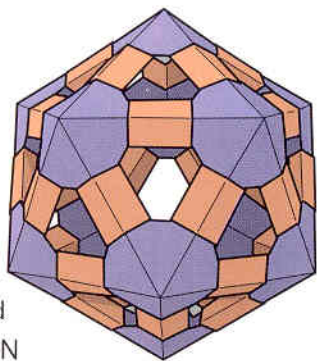

The completed ICOSAHEDRON

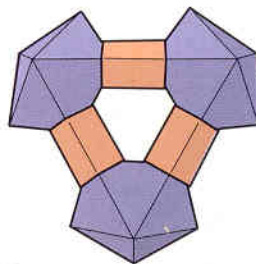

⑰ Assemble the other faces the same way.

STARS

TRUNCATED ICOSAHEDRAL STAR

● Explanation: Page 87

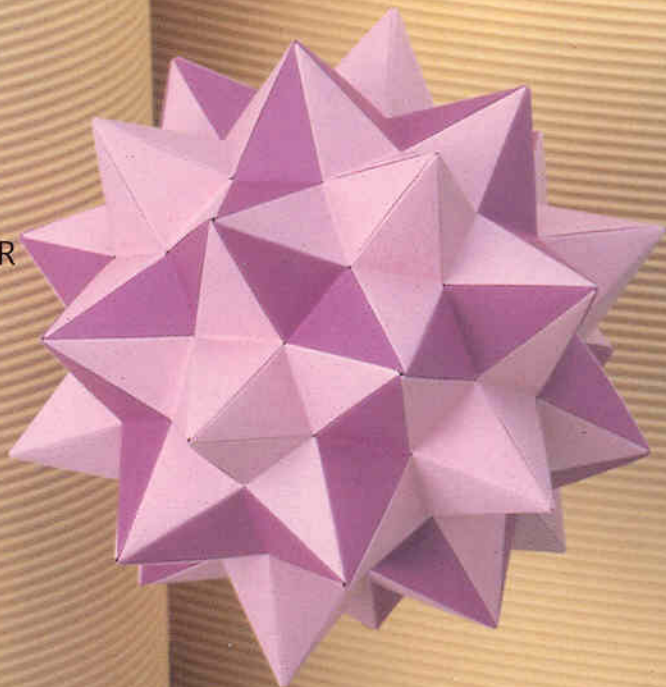

ICOSAHEDRAL STAR

● Diagram: Page 80

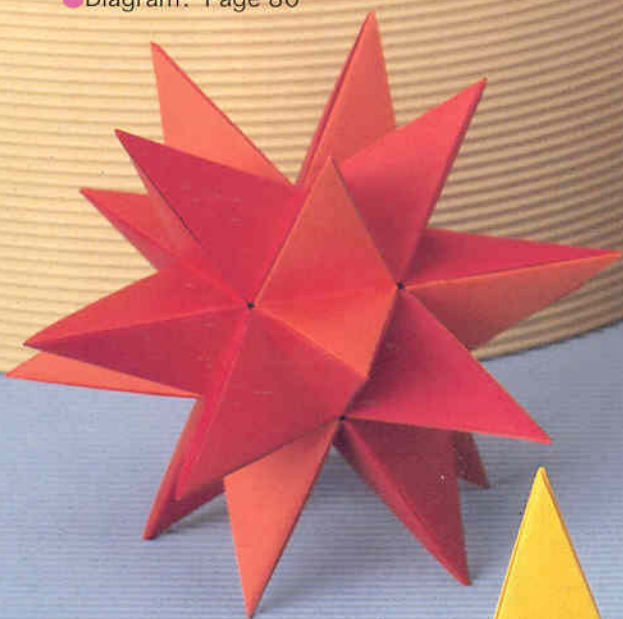

TRUNCATED OCTAHEDRAL STAR

● Diagram: Page 85

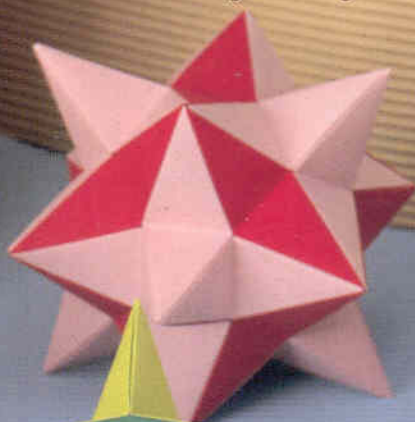

TRUNCATED TETRAHEDRAL STAR

● Diagram: Page 83

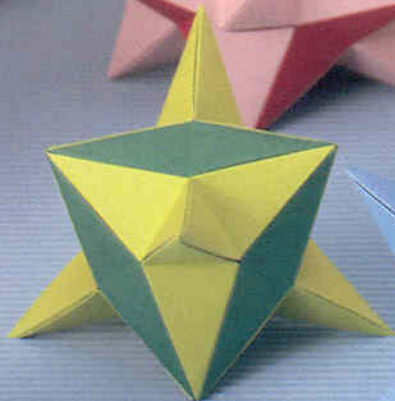

TETRAHEDRAL STAR

● Diagram: Page 76



TRUNCATED CUBE STAR

● Diagram: Page 84



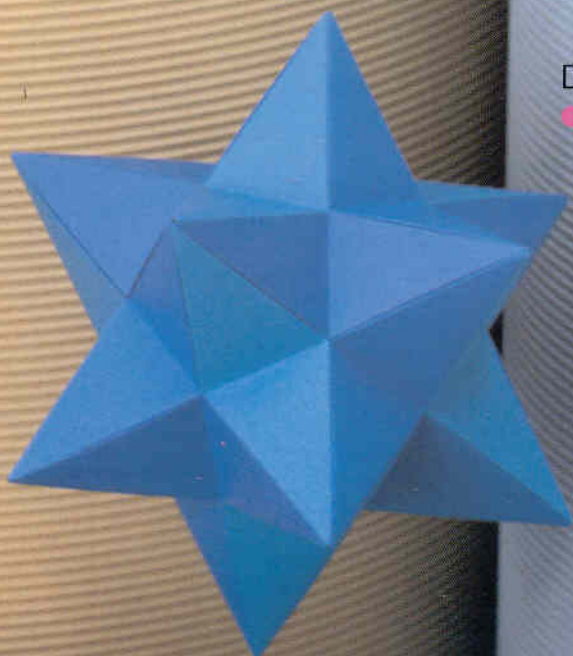

DODECAHEDRAL STAR

● Diagram: Page 79



ICOSIDODECAHEDRAL STAR

● Diagram: Page 82



CUBE STAR

● Diagram: Page 77

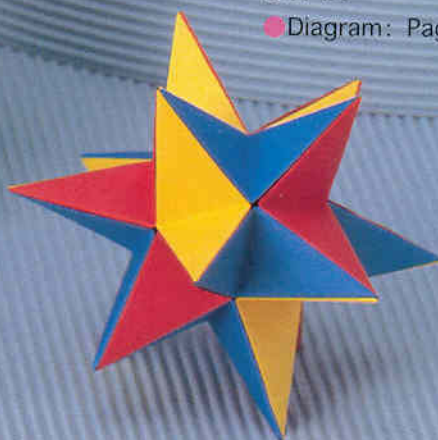

CUBOCTAHEDRAL STAR

● Diagram: Page 81



OCTAHEDRAL STAR

● Diagram: Page 78

STAR MODULE

ほしがた ゆにっと
星形のユニット
HOSHI-GATA NO YU-NIT TO

Start with a square piece of paper.

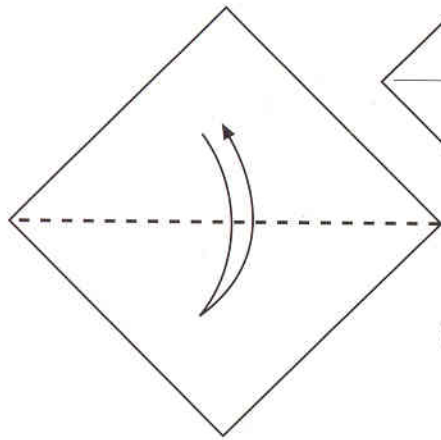

① Fold in half and unfold.

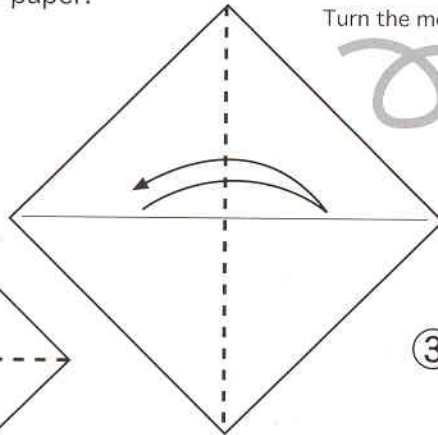

② Fold in half and unfold.

Turn the model over

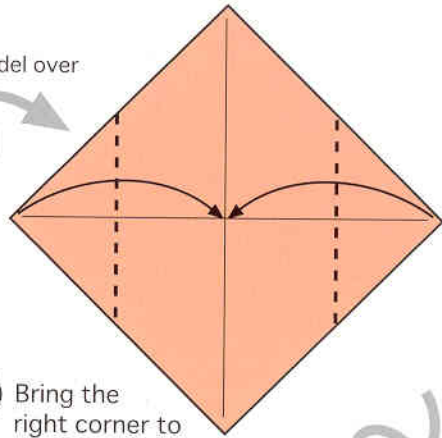

③ Bring the right corner to the center point and fold. Do the same on the left side.

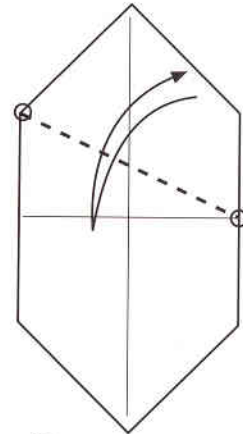

Turn the model over

④ Fold the top point down along the line connecting the two points marked ○ and unfold.

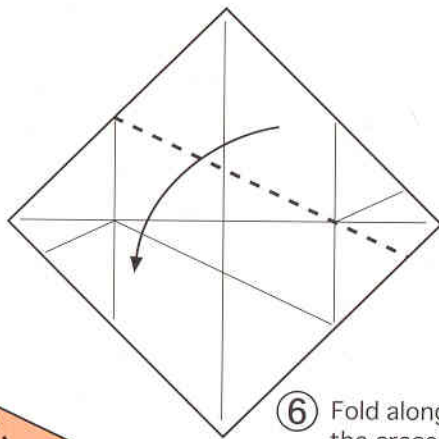

⑤ Fold the bottom point up along the line connecting the two points marked ○ and then unfold back to a square.

⑥ Fold along the crease line.

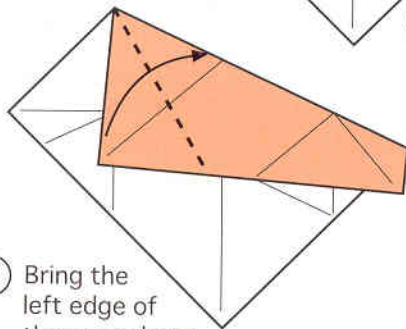

⑦ Bring the left edge of the upper layer to the top edge and fold.

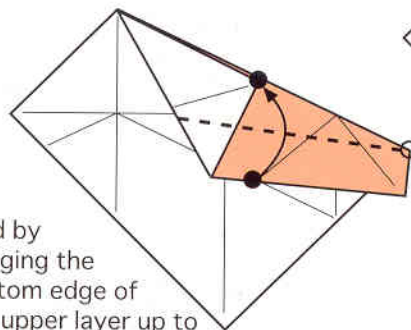

⑧ Fold by bringing the bottom edge of the upper layer up to the corner marked ●.

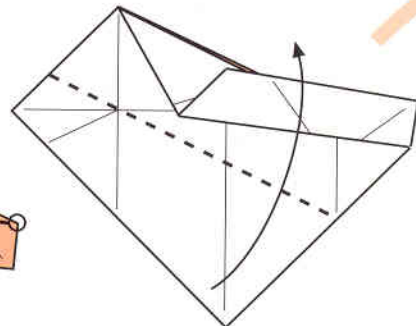

⑨ Fold along the crease line.

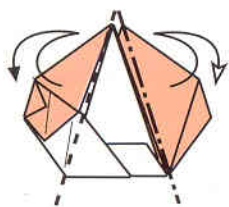

⑩⑥ Fold along the edges and unfold.

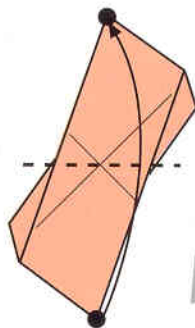

⑩⑤ Fold by bringing the two points together.

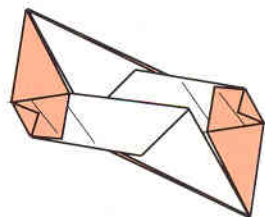

⑩④ Turn the model over.

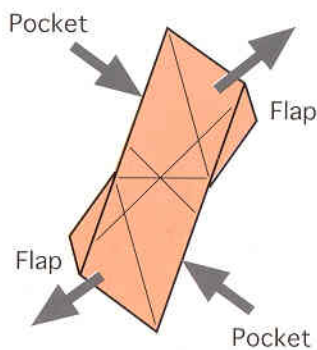

The completed Star Module

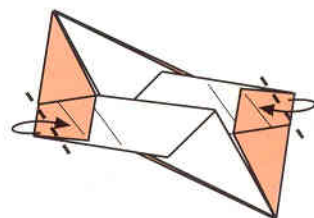

⑩③ Fold the two corners.

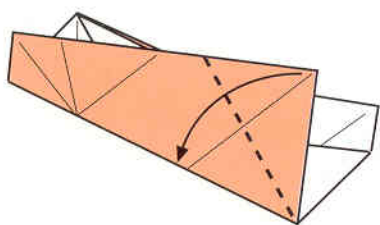

⑩⑩ Bring the right edge of the upper layer to the bottom edge and fold.

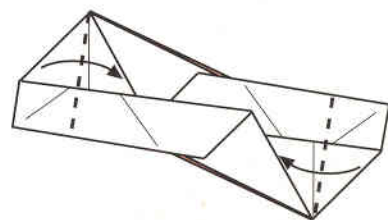

⑩② Bring the right edge to the inside slanted edge and fold. Do the same on the left side.

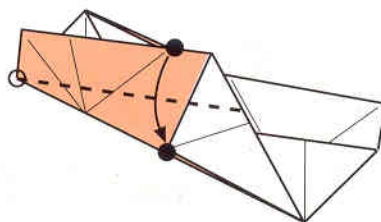

⑩① Fold by bringing the top edge of the upper layer down to the corner marked ●.

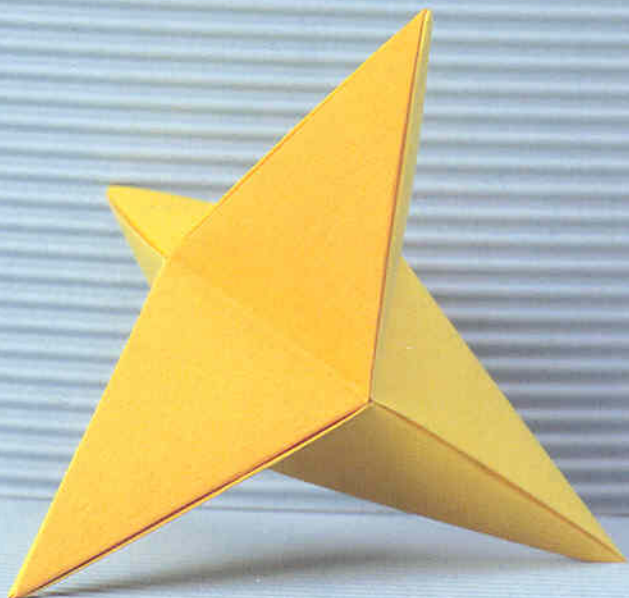

TETRAHEDRAL STAR

せいしめんたい ほしがた
 正四面体の星形
 SEI-SHI-MEN-TAI NO HOSHI-GATA

You need 6 Star Modules on page 74.
 (This model is unstable and will need some glue to hold together.)

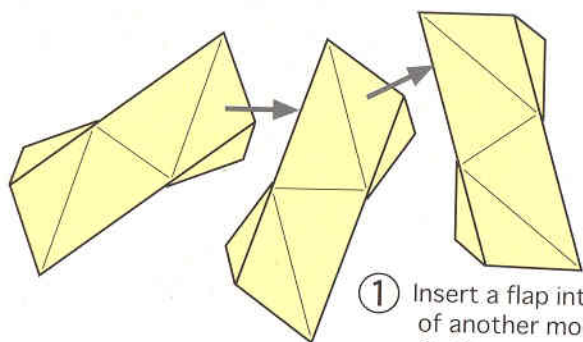

① Insert a flap into a pocket of another module. Do the same once more.

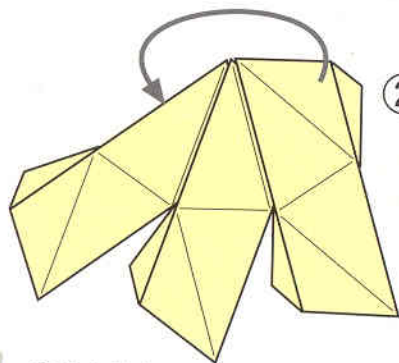

② Tuck the flap into the pocket and make a mountain shape.

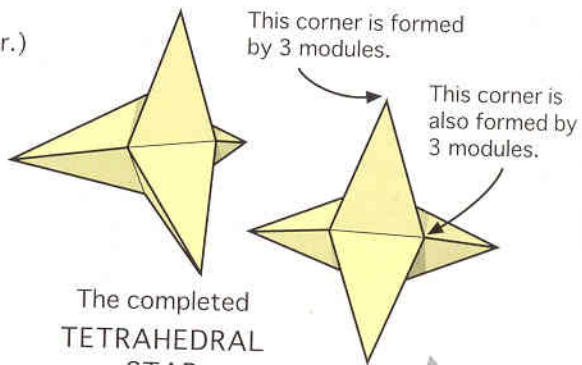

The completed
 TETRAHEDRAL
 STAR

③ Assemble the other three points as shown in the diagram.

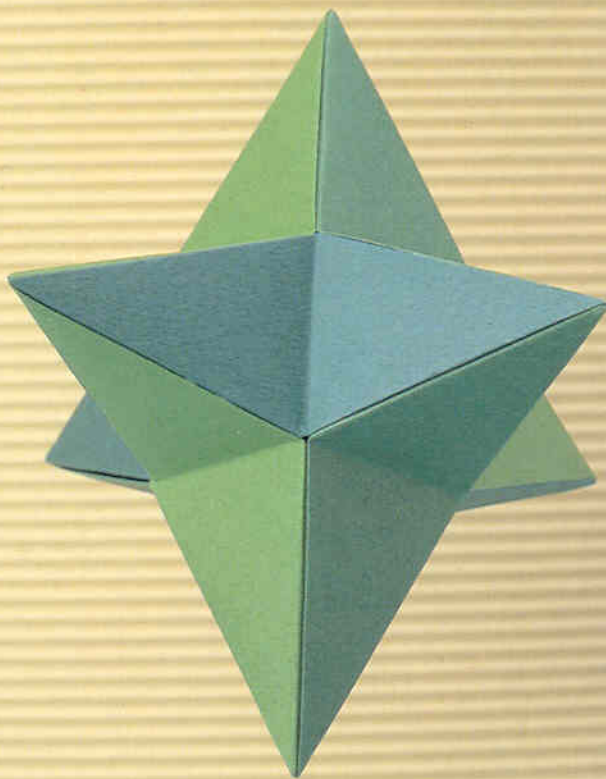

CUBE STAR

りっぽうたい ほしがた
立方体の星形
RIP-POU-TAI NO HOSHI-GATA

You need 12 Star Modules on page 74.
(This model is unstable and will need some glue to hold together.)

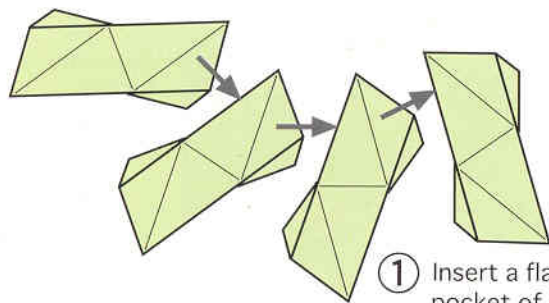

- ① Insert a flap into a pocket of another module. Do the same two more times.

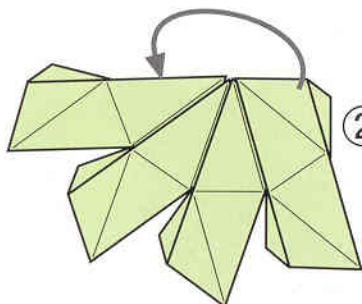

- ② Tuck the flap into the pocket and make a mountain shape.

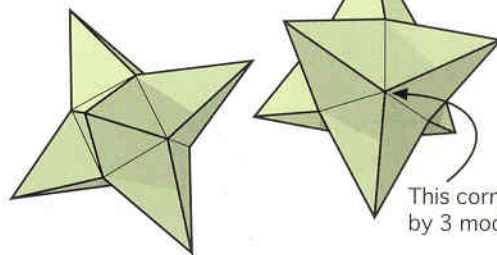

This corner is formed by 4 modules.

This corner is formed by 3 modules.

The completed CUBE STAR

- ③ Assemble the other five points as shown in the diagram.

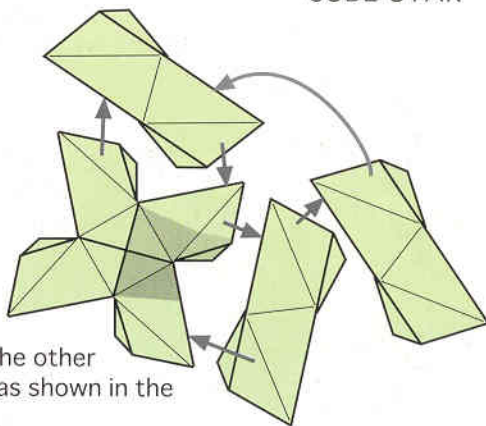

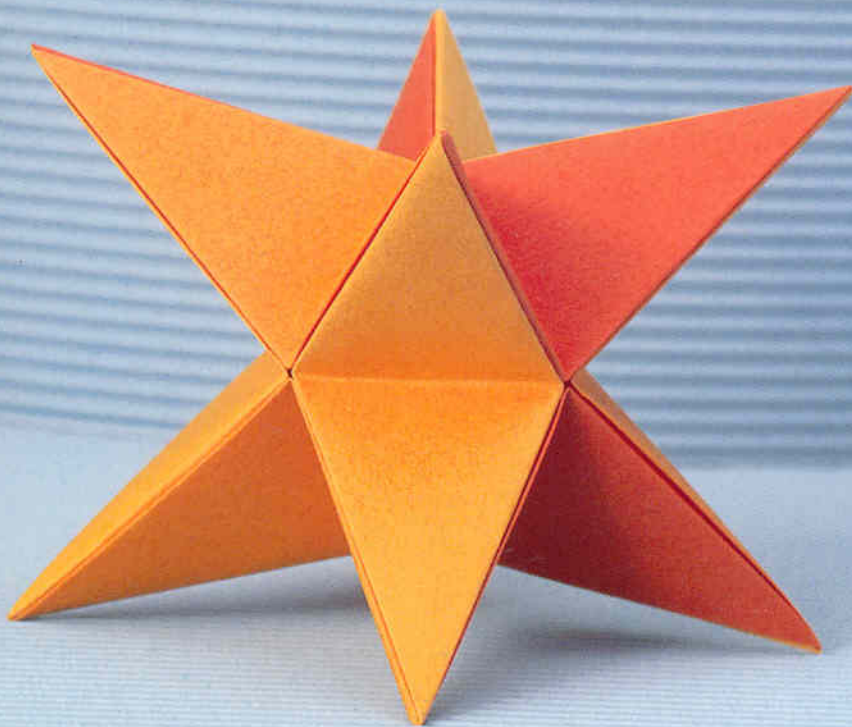

OCTAHEDRAL STAR

せいちめんたい ほしがた
正 8 面体の星形
SEI-HACHI-MEN-TAI NO HOSHI-GATA

You need 12 Star Modules on page 74.
(This model is unstable and will need some glue to hold together.)

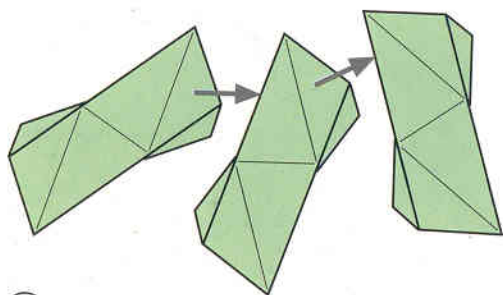

- ① Insert a flap into a pocket of another module.
Do the same once more.

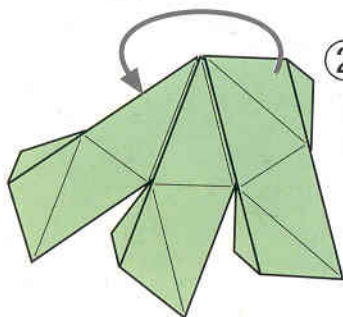

- ② Tuck the flap into the pocket and make a mountain shape.

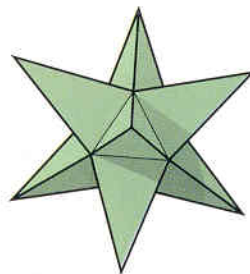

The completed
OCTAHEDRAL
STAR

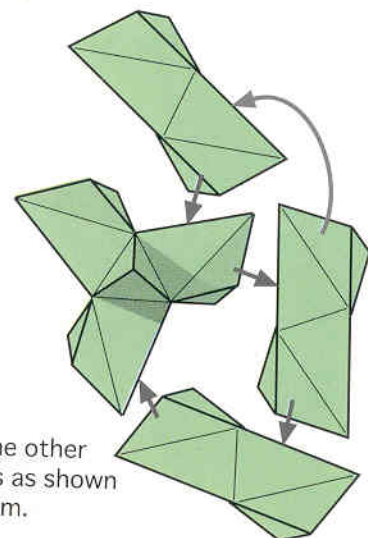
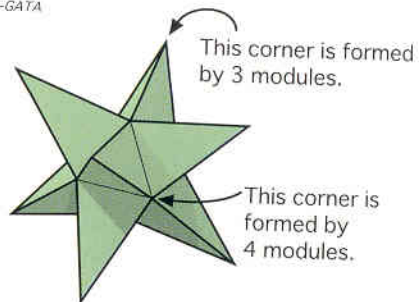

- ③ Assemble the other seven points as shown in the diagram.

DODECAHEDRAL STAR

せいじゅうにめんたい ほしがた
正 12 面体の星形
SEI - JUJUNI - MEN - TAI NO HOSHI - GATA

You need 30 Star Modules on page 74.
(This model is unstable and will need some glue to hold together.)

- ① Insert a flap into a pocket of another module. Do the same three more times.

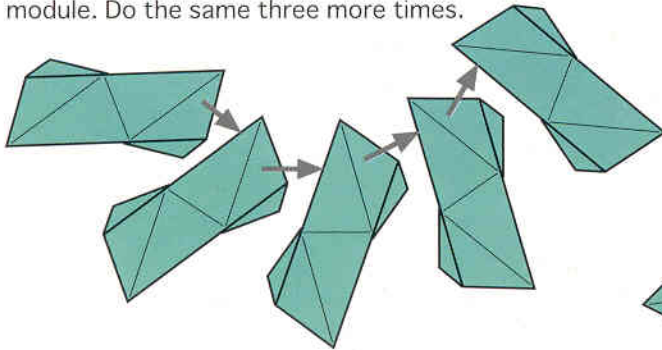

- ② Tuck the flap into the pocket and make a mountain shape.

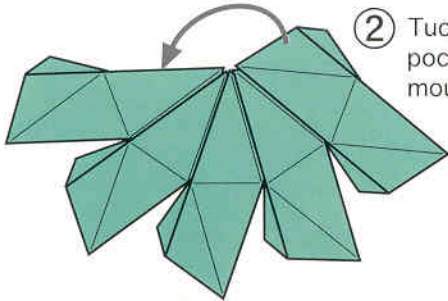

The completed
DODECAHEDRAL
STAR

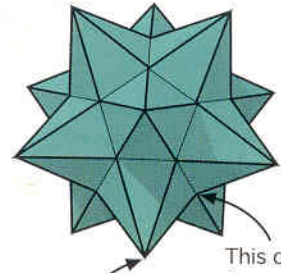

This corner is formed by 3 modules.

This corner is formed by 5 modules.

- ③ Assemble the other 11 points as shown in the diagram.

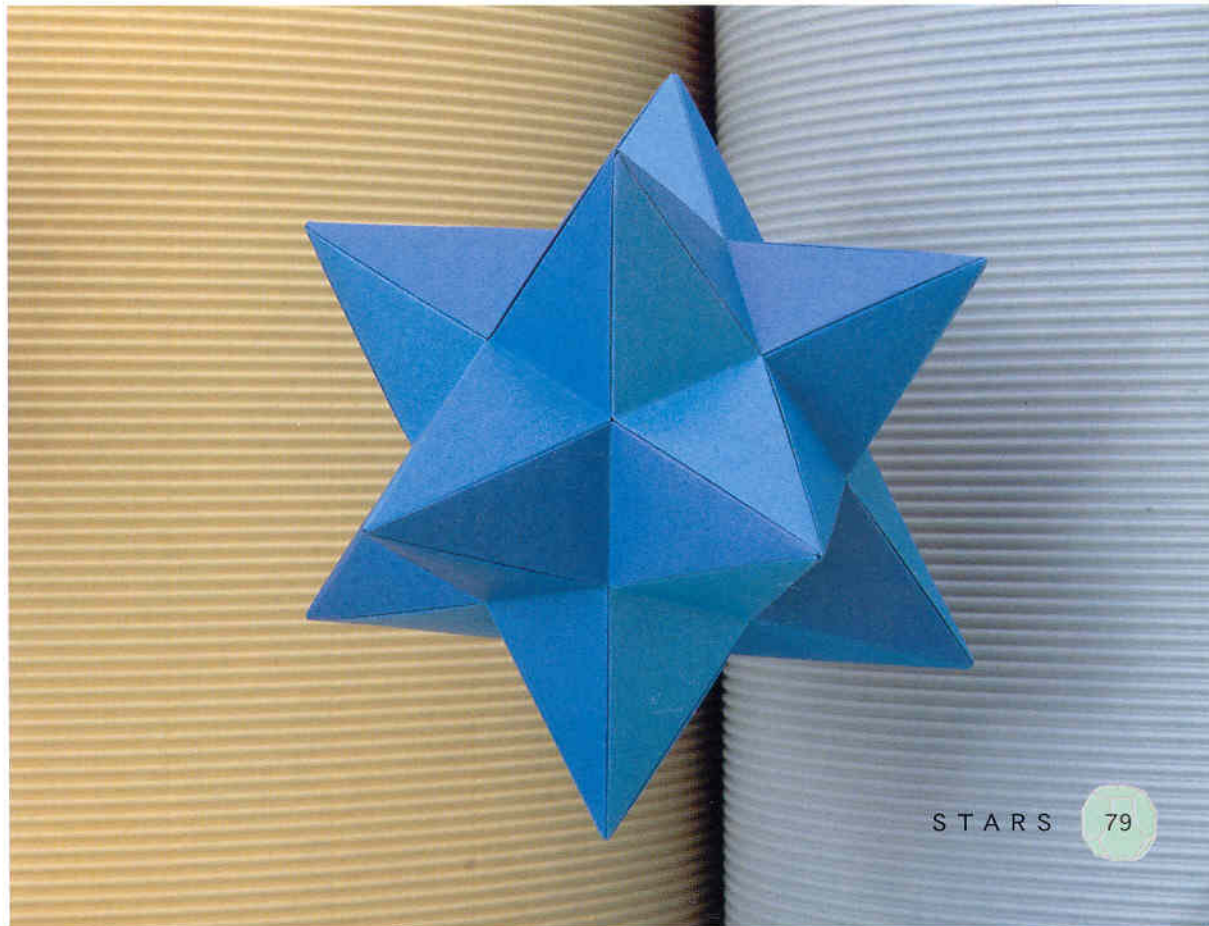
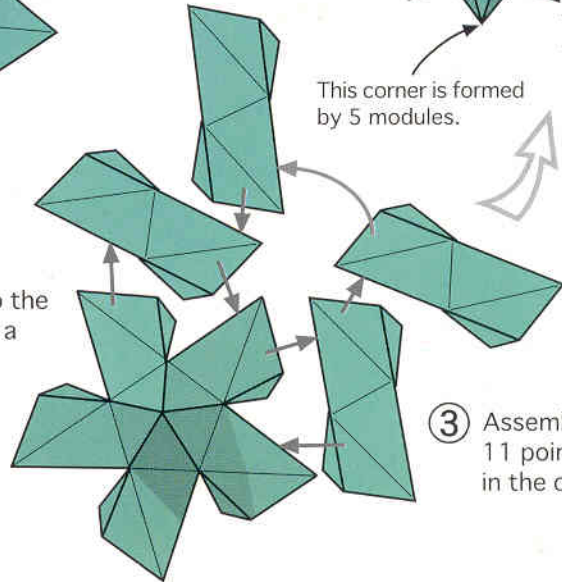

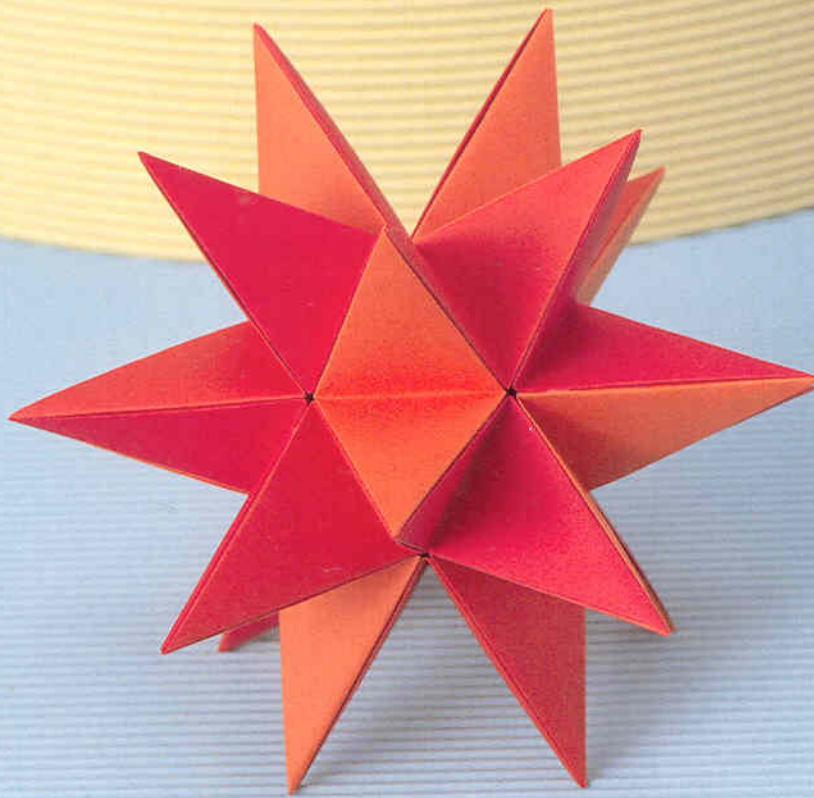

ICOSAHEDRAL STAR

せいじゅうめんたい ほしがた
 正 20 面体の星形
 SEI - NIJUJU-MEN-TAI NO HOSHI-GATA

You need 30 Star Modules on page 74.
 (This model is unstable and will need some glue to hold together.)

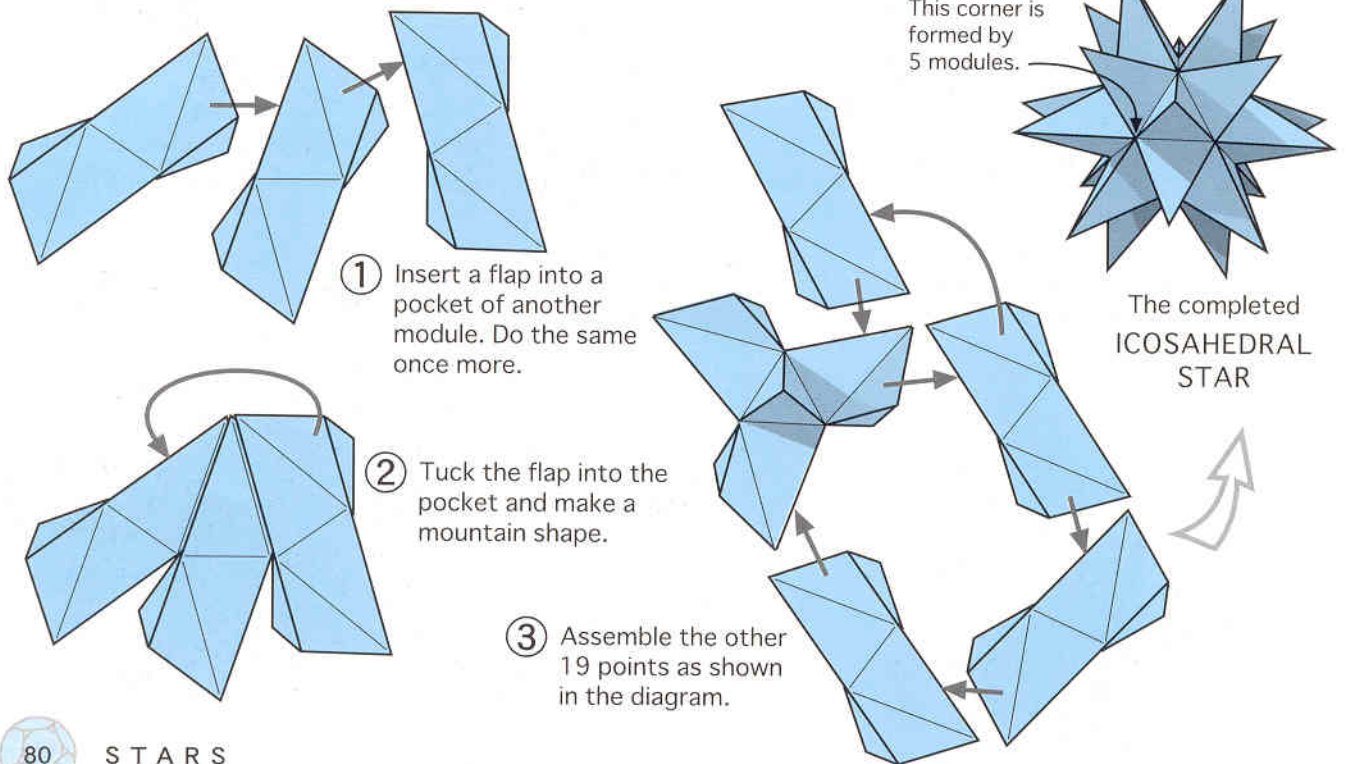

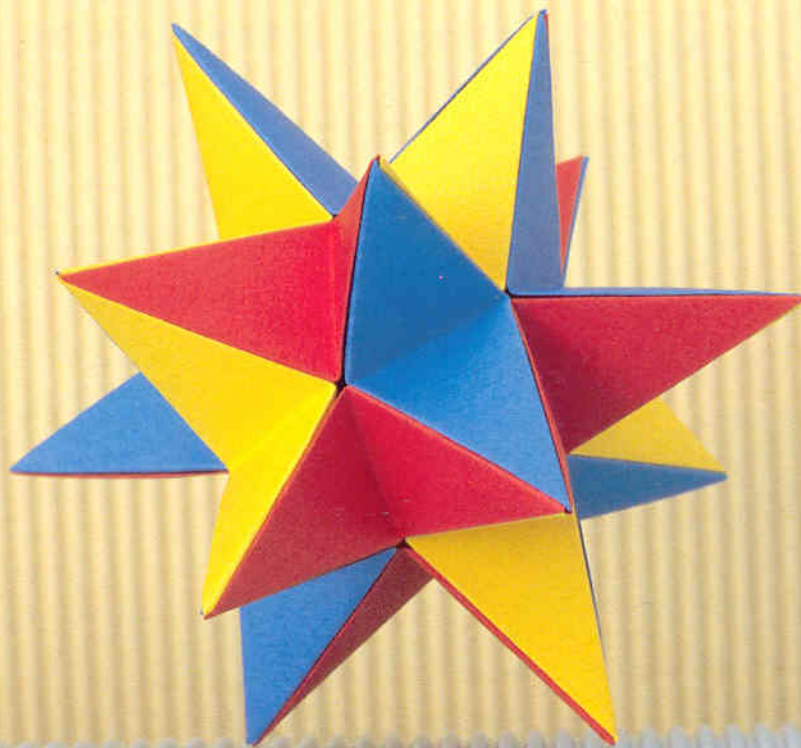

CUBOCTAHEDRAL STAR

リッぽうはちめんたい ほしがた
立方8面体の星形
RIP-POU-HACHI-MEN-TAI NO HOSHI-GATA

You need 24 Star Modules on page 74.

(This model is unstable and will need some glue to hold together.)

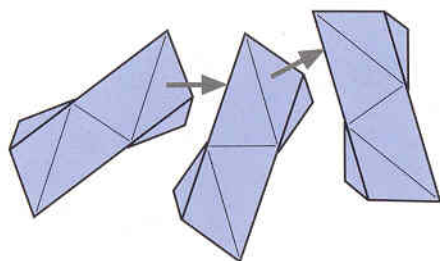

- ① Insert a flap into a pocket of another module. Do the same once more.

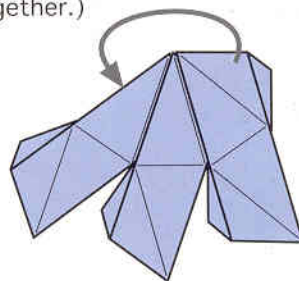

- ② Tuck the flap into the pocket and make a mountain shape.

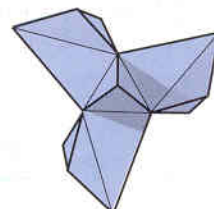

- ③ This is one unit. You need 8 units.

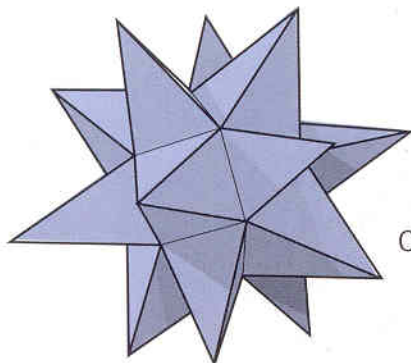

The completed
CUBOCTAHEDRAL
STAR

- ④ Assemble the other six points as shown in the diagram.

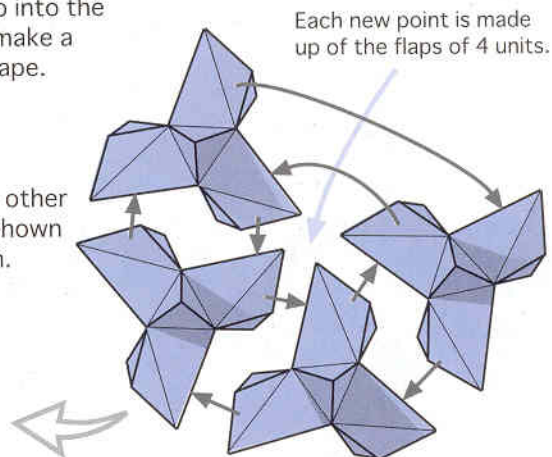

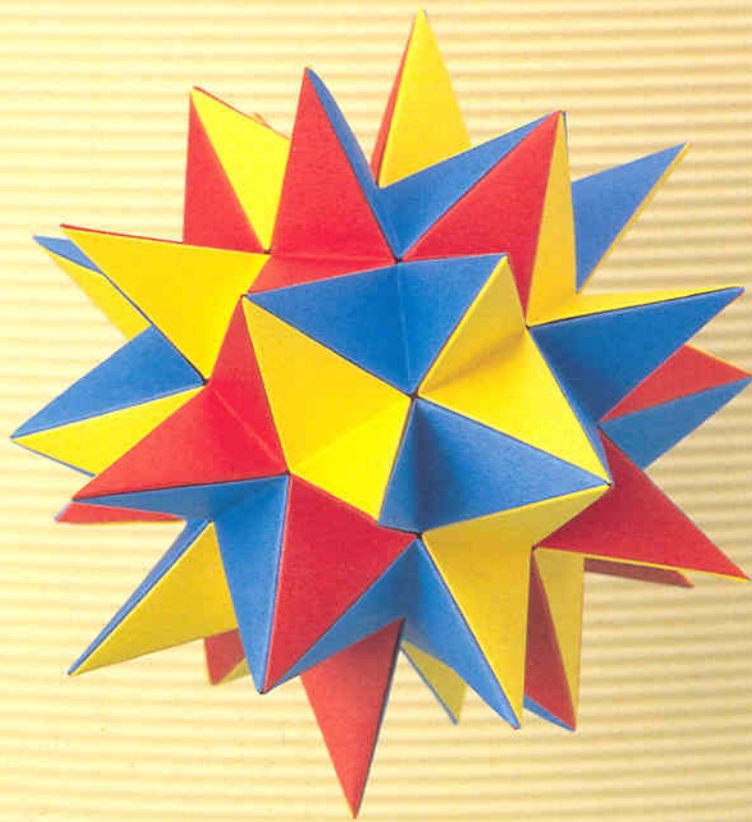

ICOSIDODECAHEDRAL STAR

にじゅうじゅうにめんたい ほしがた
20・12 面体の星形
NIJUJU - JUUNI - MEN - TAI NO HOSHI-GATA

You need 60 Star Modules on page 74.
(This model is unstable and will need some glue to hold together.)

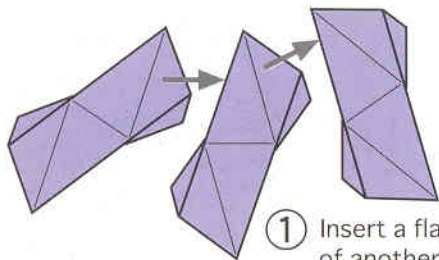

① Insert a flap into a pocket of another module. Do the same once more.



② Tuck the flap into the pocket and make a mountain shape.

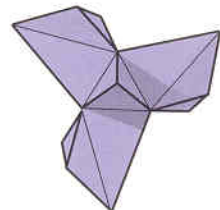

③ This is one unit. You need 20 units.

Each new point is made up of the flaps of 5 units.

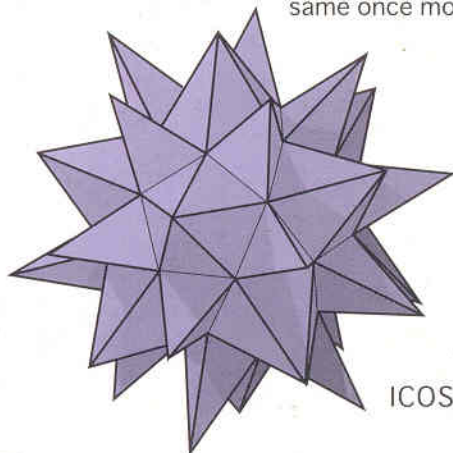

The completed
ICOSIDODECAHEDRAL
STAR

④ Assemble the other 12 points as shown in the diagram.

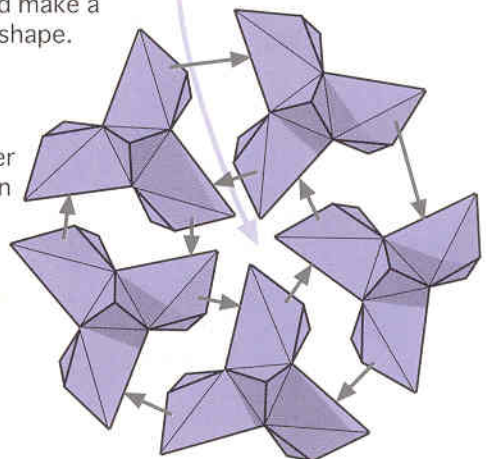

TRUNCATED TETRAHEDRAL STAR

せっちょうし めんたい ほしがた
切頂 4 面体の星形
SET-CHOU-SHI-MEN-TAI NO HOSHI-GATA

You need 18 Star Modules on page 74.

(This model is unstable and will need some glue to hold together.)

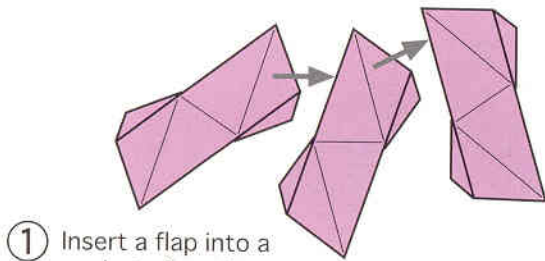

- ① Insert a flap into a pocket of another module. Do the same once more.

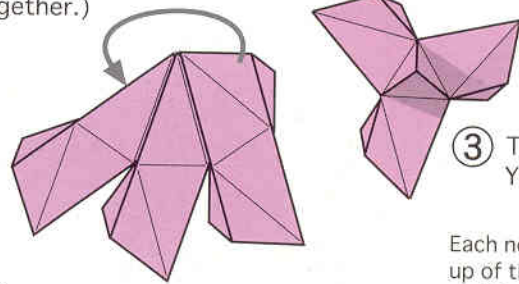

- ② Tuck the flap into the pocket and make a mountain shape.

- ③ This is one unit.
You need 4 units.

Each new point is made up of the flaps of 3 units and 3 modules.

- ④ Assemble the other four points as shown in the diagram.

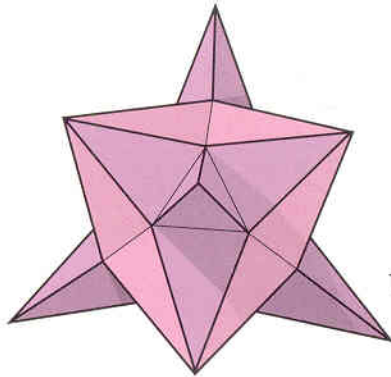
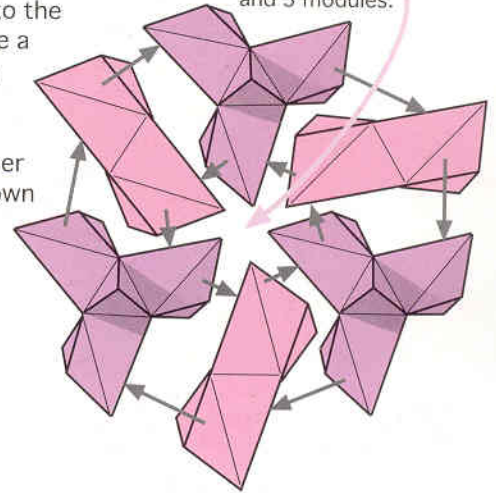

The completed
TRUNCATED
TETRAHEDRAL
STAR

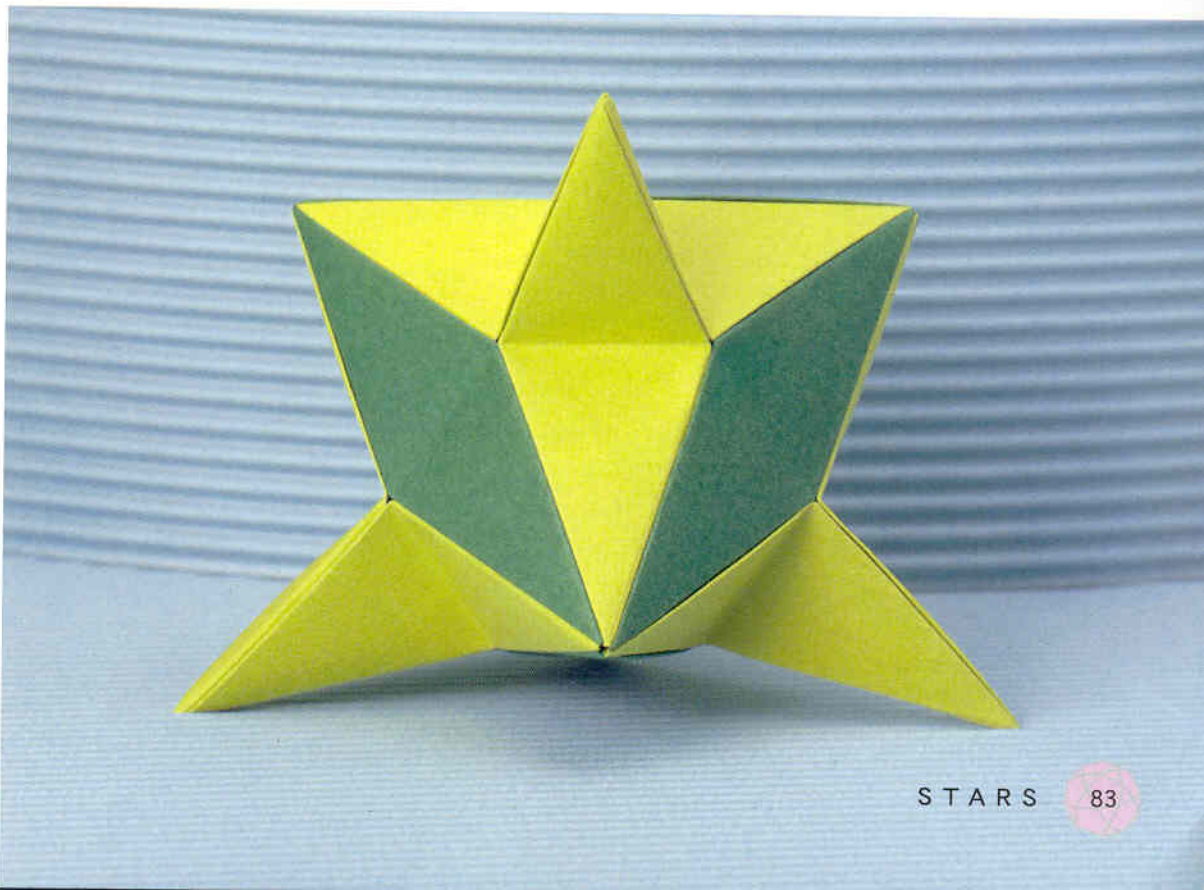

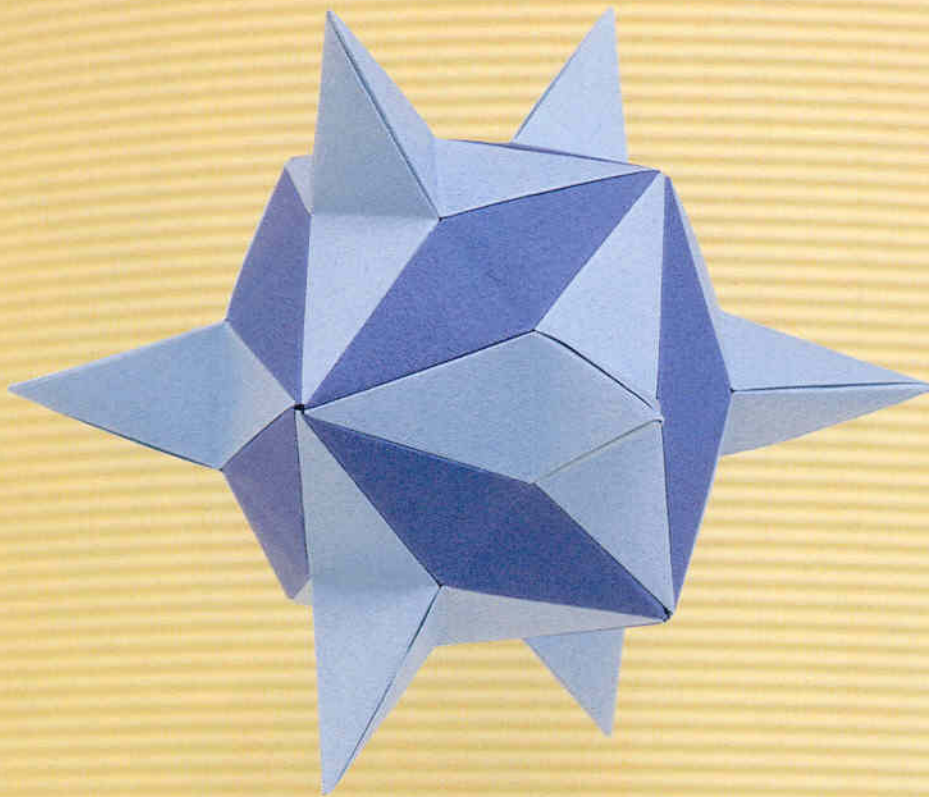

TRUNCATED CUBE STAR

せつちようりっぽうたい ほしがた
切頂立方体の星形
SET-CHOU-RIP-POU-TAI NO HOSHI-GATA

You need 36 Star Modules on page 74.
(This model is unstable and will need some glue to hold together.)

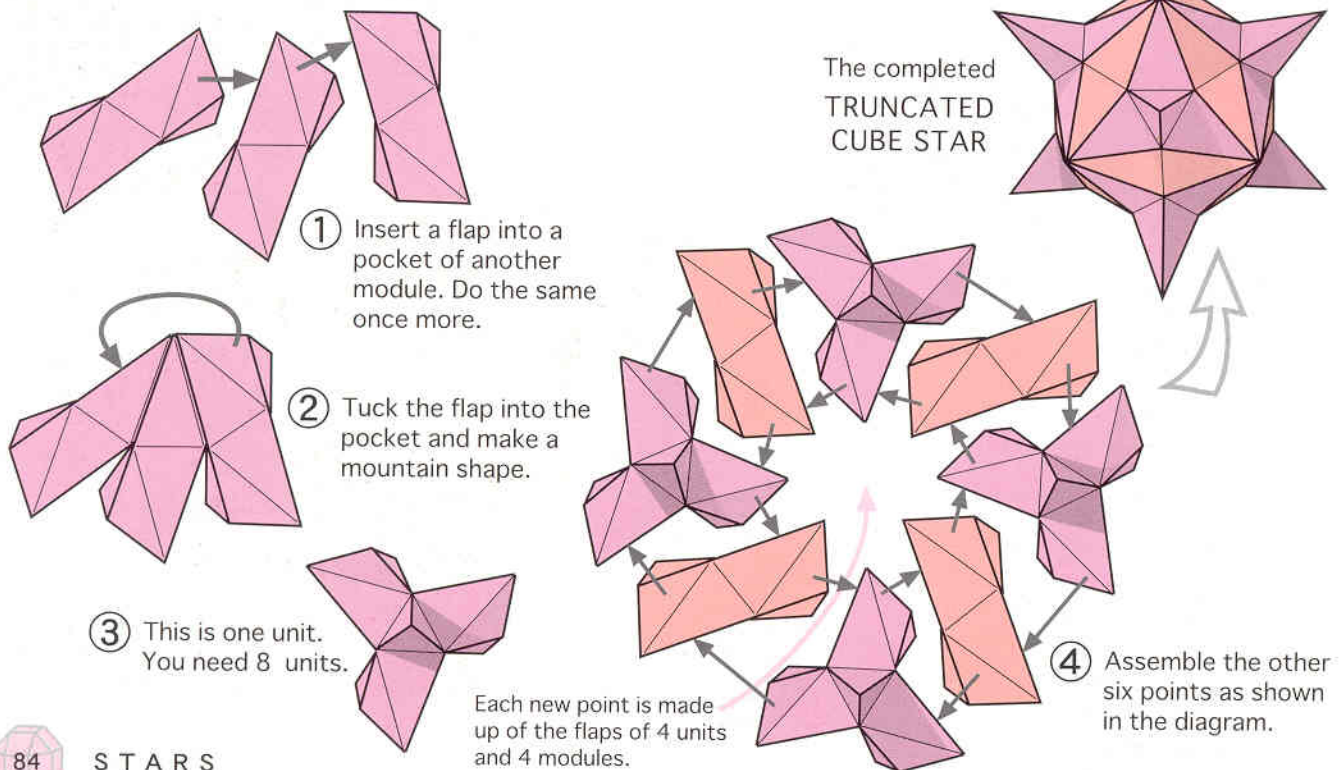

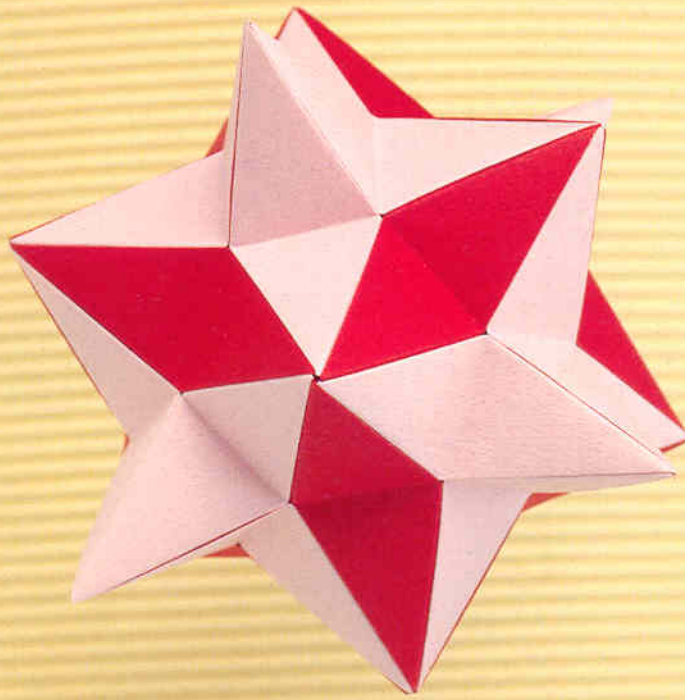

TRUNCATED OCTAHEDRAL STAR

せつちょうはちめんたい ほしがた
切頂 8 面体の星形
SET-CHOU-HACHI-MEN-TAI NO HOSHI-GATA

You need 36 Star Modules on page 74.
(This model is unstable and will need some glue to hold together.)

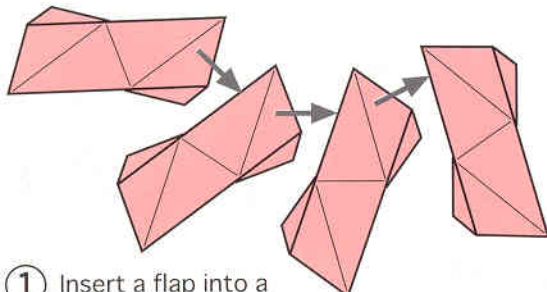

- ① Insert a flap into a pocket of another module. Do the same two more times.

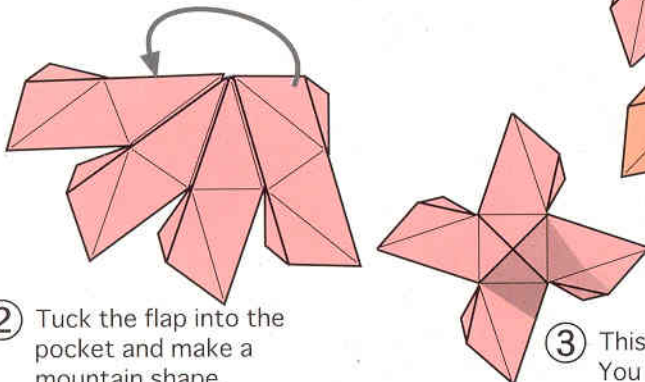

- ② Tuck the flap into the pocket and make a mountain shape.

- ③ This is one unit. You need 6 units.

The completed
TRUNCATED
OCTAHEDRAL
STAR

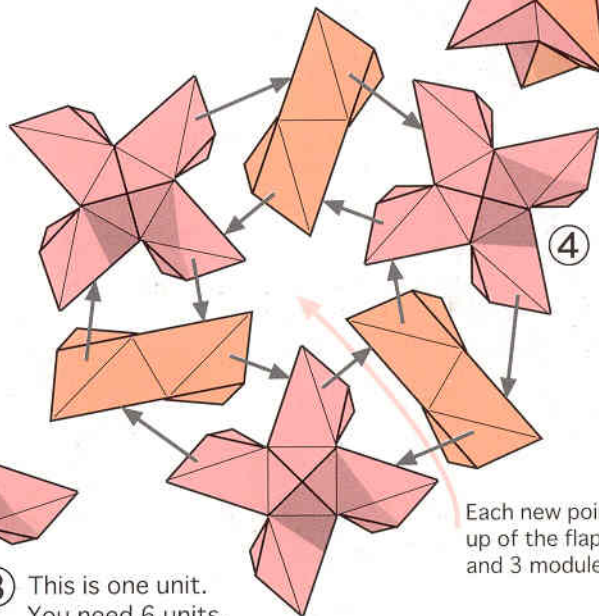
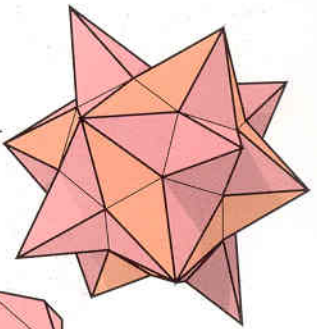

- ④ Assemble the other eight points as shown in the diagram.

Each new point is made up of the flaps of 3 units and 3 modules.

STAR POLYHEDRA

ほしがた ためんたい
星形多面体
HOSHI-GATA-TA-MEN-TAI

- We can imagine various star polyhedra based on the regular and semi-regular polyhedra. The method of making these star polyhedra is very similar to the method for making star polygons.

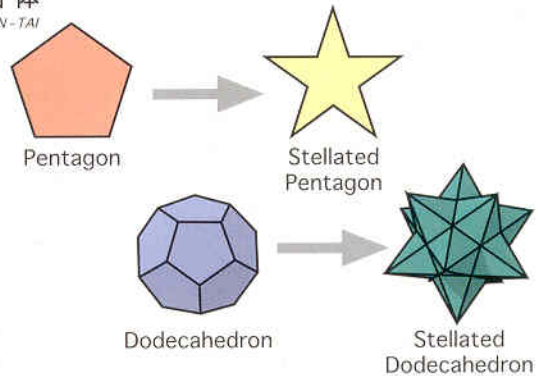

Method 1:

By extending the edges or faces.
(This is called "Stellation")

- Polygon

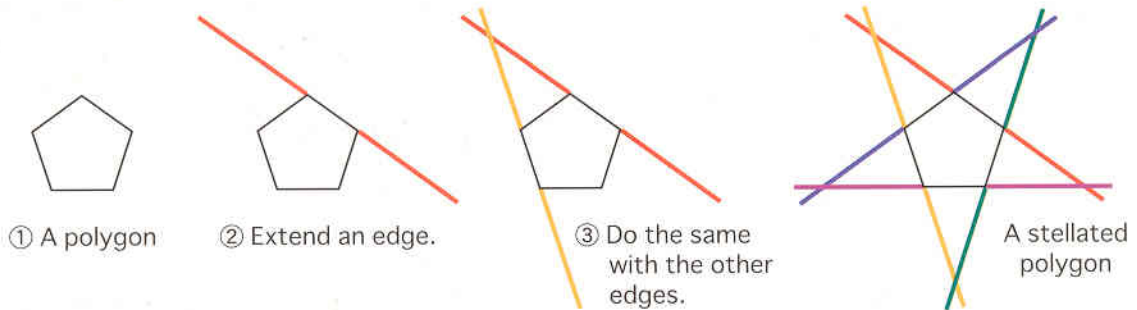

- Polyhedron

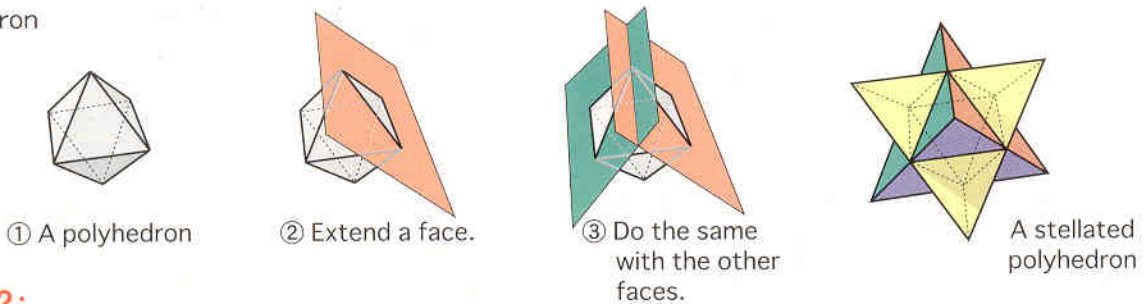

Method 2:

By connecting the vertices or edges.

- Polygon

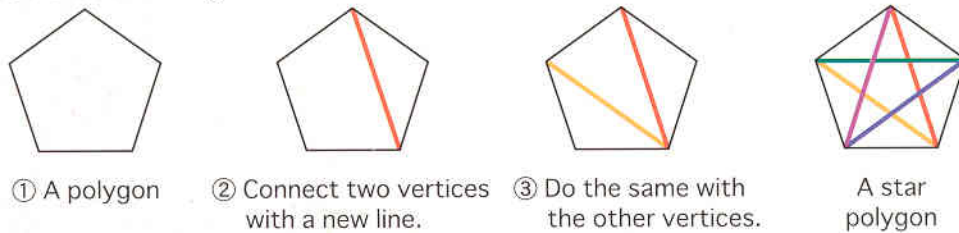

- Polyhedron

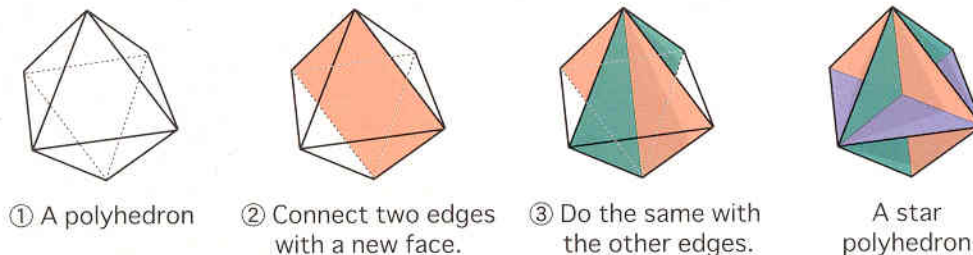

Method 3:

By putting points on the edges or faces.

● Polygon

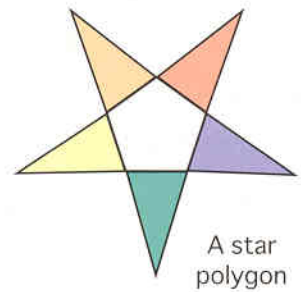
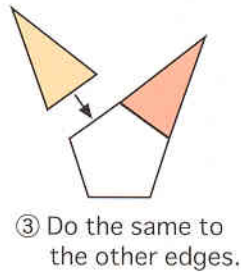
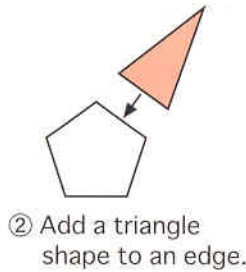
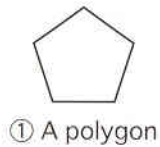

● Polyhedron

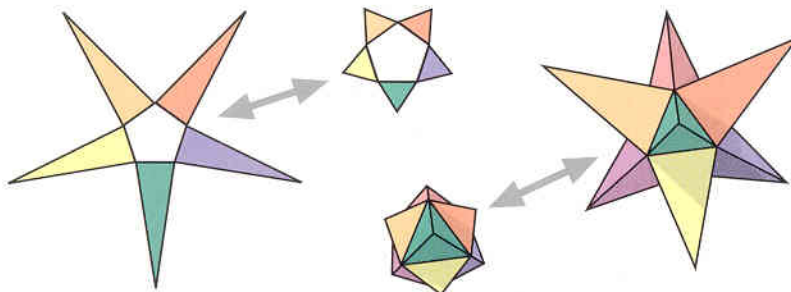
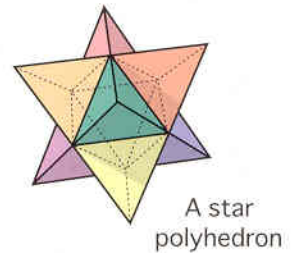
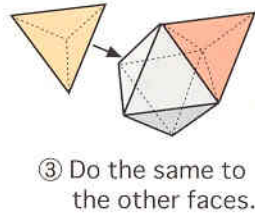
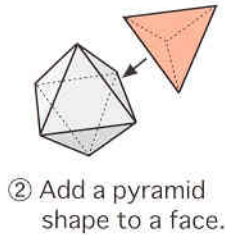
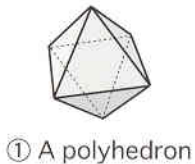

You can add a point of any size.

- There are many more kinds of stellated polyhedra. You can imagine and make various stars based on the tables on pages 28 and 29! For example, the star in the picture to the right was made with 90 Star Modules (see page 74) arranged as a truncated icosahedron.

TRUNCATED ICOSAHEDRAL STAR

せつちやうにしじゅうめんたい ほしがた
切頂 20 面体の星形
SET-CHOU-NIJUJU-MEN-TAI NO HOSHI-GATA



FLUTTER WHEELS

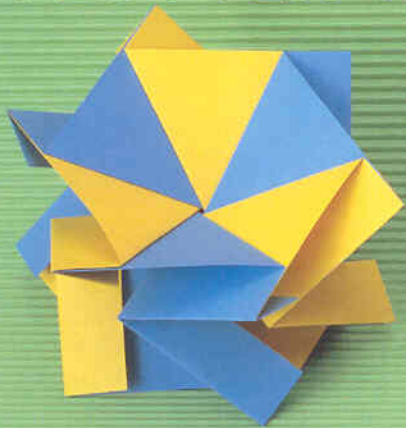

FLUTTER WHEEL 1

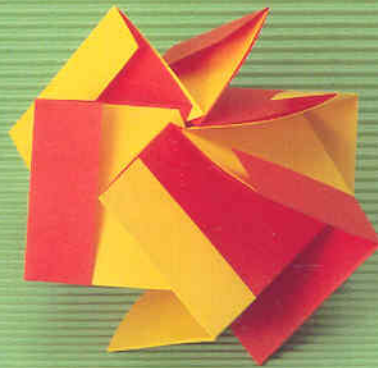

FLUTTER WHEEL 2

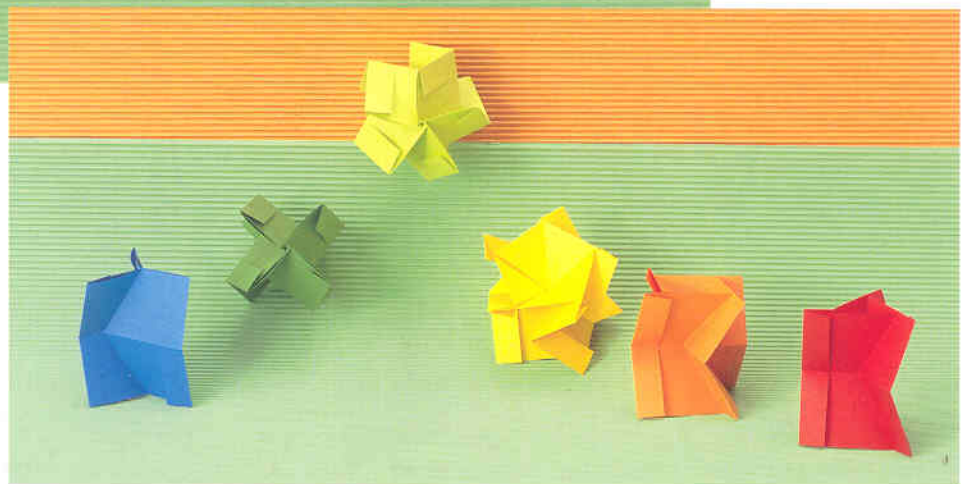

FLUTTER WHEELS

すいしゃ
水車
SUI-SHA

You need 6 square pieces of paper, all the same size for each type of model.

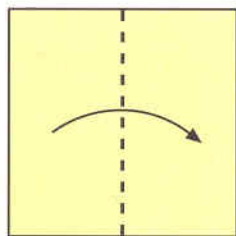

① Fold in half.

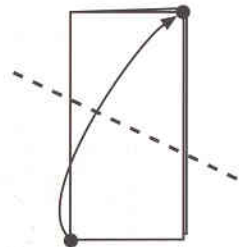

② Fold by bringing the two points together.

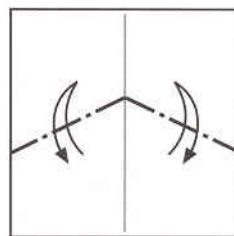

④ Mountain fold along the two crease lines and unfold.

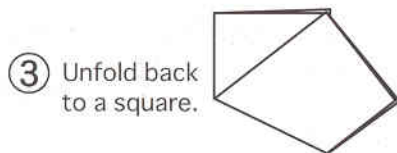

③ Unfold back to a square.

Type 1

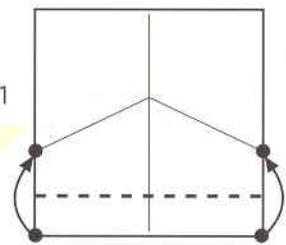

⑤ Fold by bringing the two points marked ● together.

Type 2

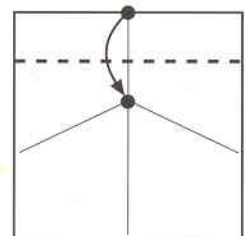

⑤ Fold by bringing the two points marked ● together.

⑨ Insert the flap into the pocket by sliding it in as far as possible.

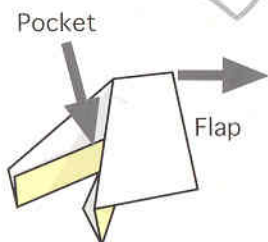

⑧ This is the Type 1 Flutter Wheel Module. You need 6 modules.

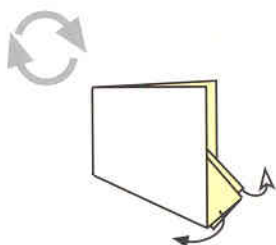

⑦ Open a little.

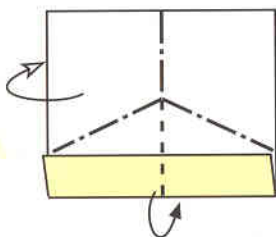

⑥ Fold along all the crease lines at once.

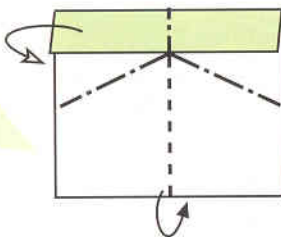

⑥ Fold along all the crease lines at once.

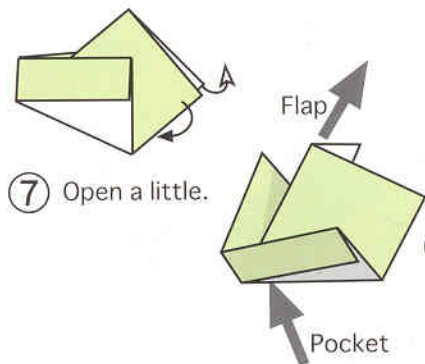

⑦ Open a little.

⑧ This is the Type 2 Flutter Wheel Module. You need 6 modules.

• You can make other models with 3~5 modules too.

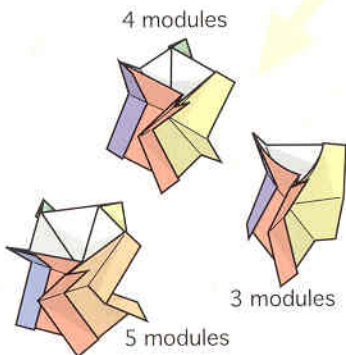
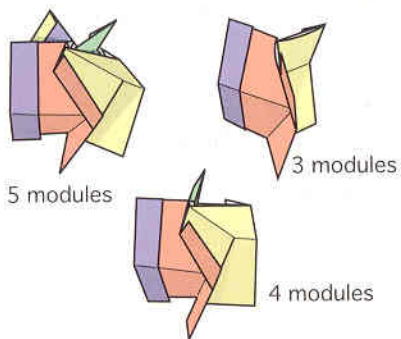

⑩ Put together all the other modules one by one.

⑪ Pull up and insert the flap into the last pocket. The model becomes 3-D.

The completed FLUTTER WHEEL 1

The completed FLUTTER WHEEL 2

⑪ Pull up and insert the flap into the last pocket. The model becomes 3-D.

⑩ Put together all the other modules one by one.

⑨ Insert the flap into the pocket by sliding it in as far as possible.

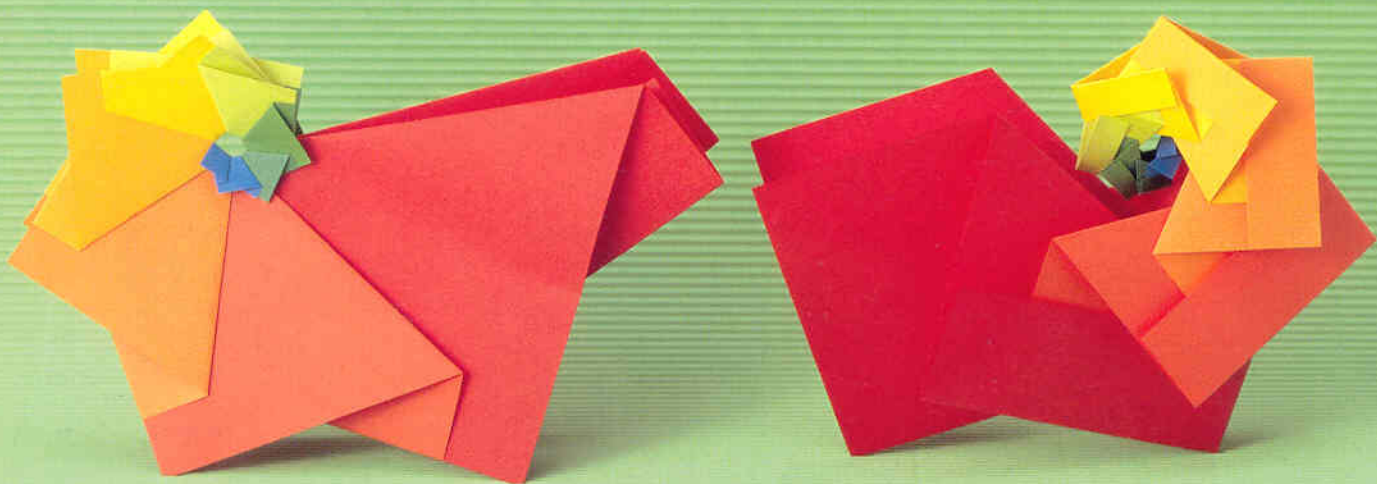

Flutter Wheel Arrangements

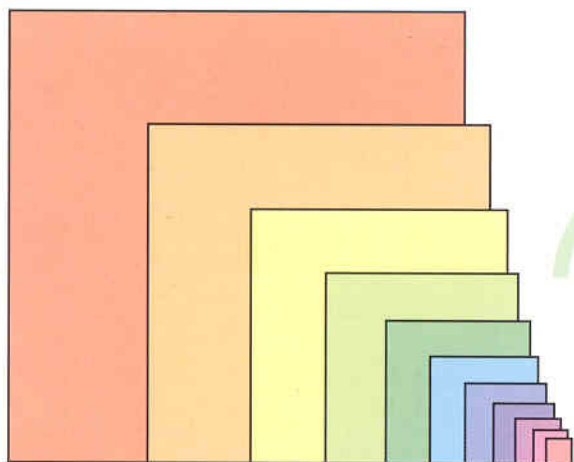

By gradually reducing the size of the Type1 or Type2 Flutter Wheel Modules (on page 88), you can create spiral shapes.

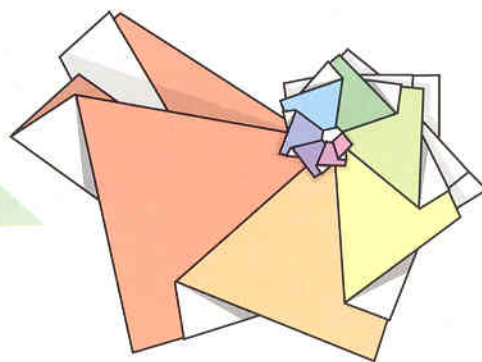

This spiral is made from Type 1 Flutter Wheel Modules.

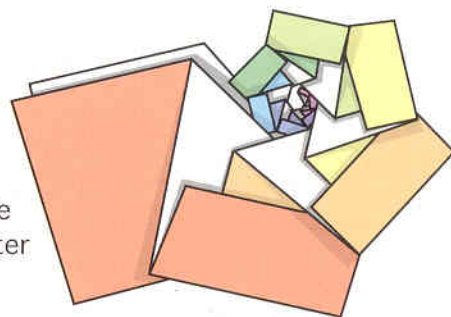

This spiral is made from Type 2 Flutter Wheel Modules.

WINDMILL

ふうしゃ
風車
FUU-SHA

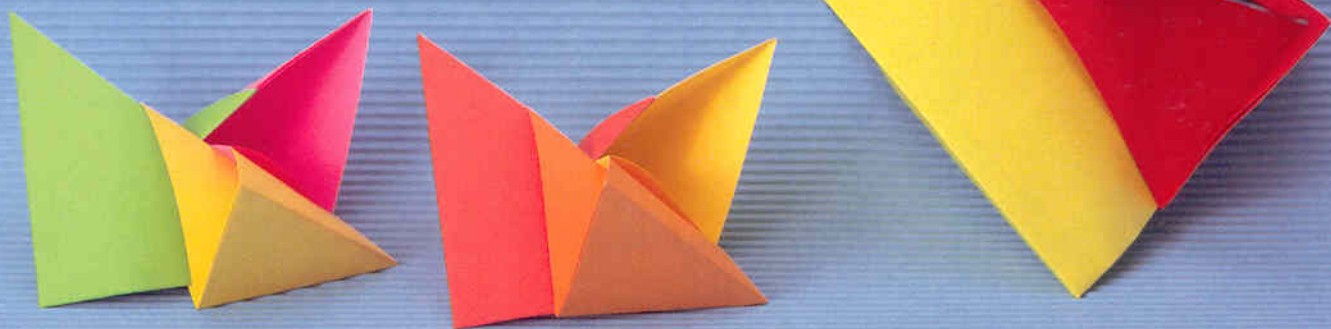

You need 3 square pieces of paper, all the same size.

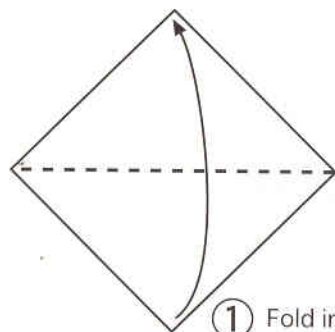

① Fold in half.

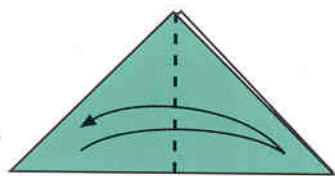

② Fold in half and unfold.

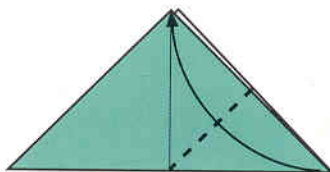

③ Bring the right point to the top corner and fold.

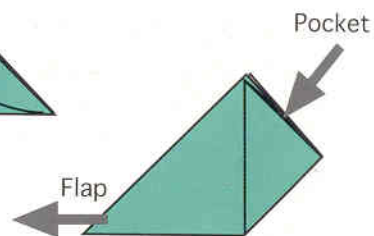

④ This is the Windmill Module. You need 3 modules.

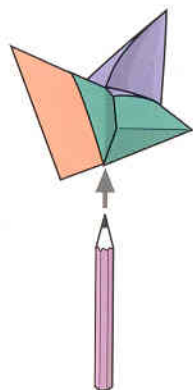

● Put the model on a stick (like a pencil) and blow gently.

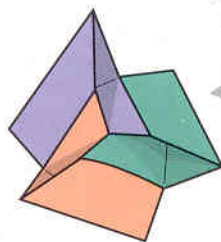

The completed WINDMILL

Turn the model over

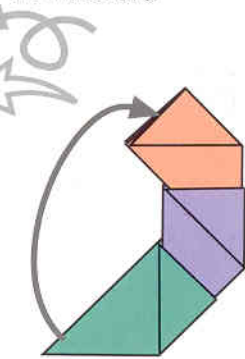

⑦ Tuck the flap into the last pocket and make a 3-D shape.

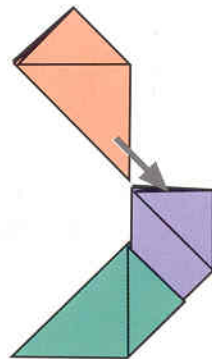

⑥ Do the same again.

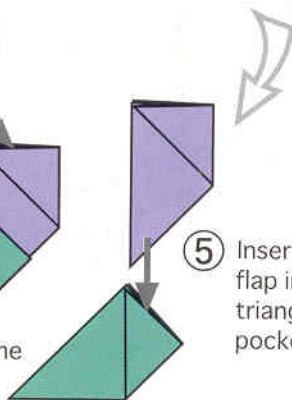

⑤ Insert the flap into the triangular pocket.

SQUARE TILE 1

せいほうけい たいるいち
 正方形のタイル 1
 SEI-HOU-KEI NO TA-I-RI ICHI

Start with a square piece of paper.

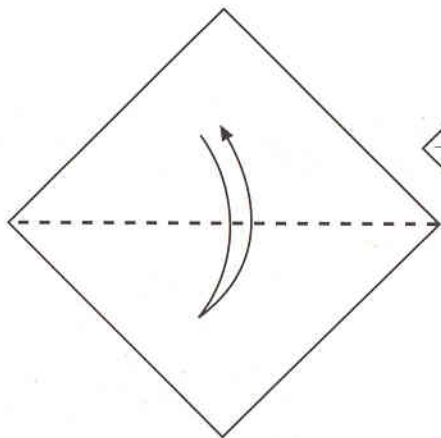

① Fold in half and unfold.

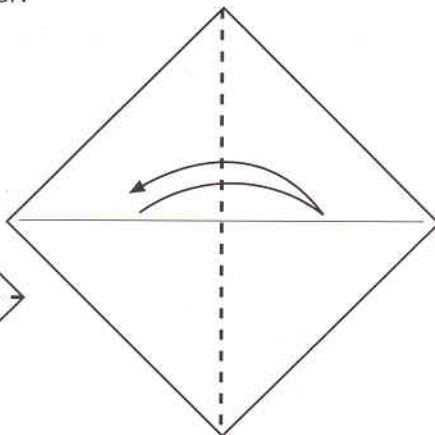

② Fold in half and unfold.

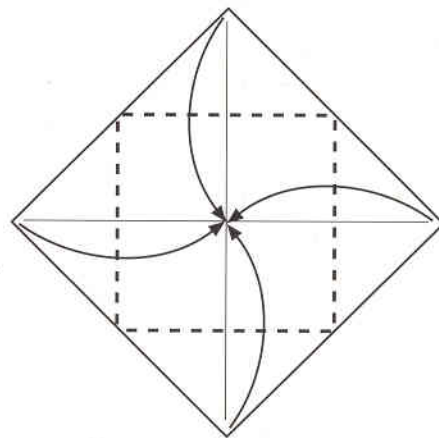

③ Bring each corner to the center point and fold.

The completed
 SQUARE TILE 1

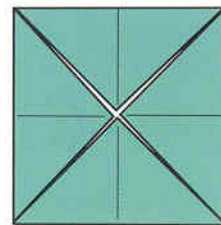
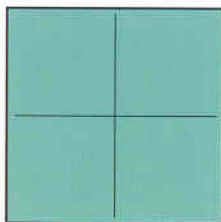

④ Turn the model over.

RECTANGULAR TILE 1

ちようほうけい たいるいち
 長方形のタイル 1
 CHOU-HOU-KEI NO TA-I-RI ICHI

Start with a square piece of paper.

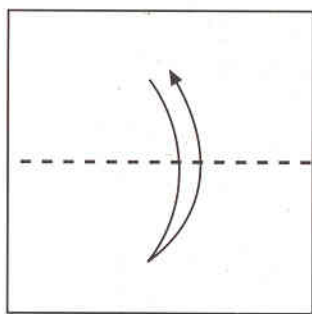

① Fold in half and unfold.

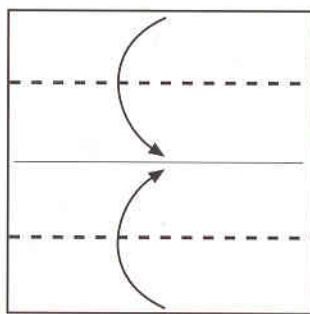

② Bring the bottom edge to the center line and fold. Do the same on the upper side.

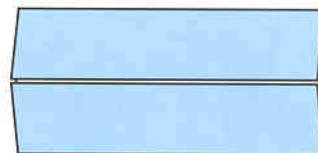

③ Turn the model over.

The completed
 RECTANGULAR TILE 1

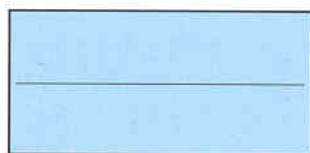

RIGHT TRIANGULAR TILE

ちよつかくさんかっけい たいる
 直角3角形のタイル
 CHOK-KAKU-SAN-KAK-KEI NO TA-1-RU

Start with a square piece of paper.

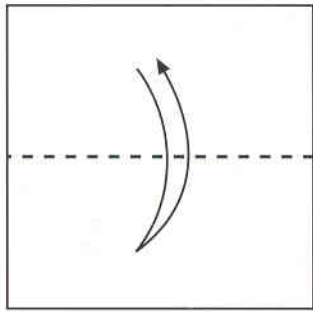

① Fold in half and unfold.

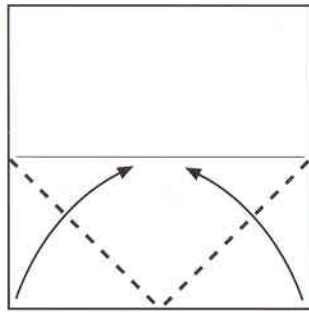

② Bring the lower right edge to the center line and fold. Do the same on the left side.

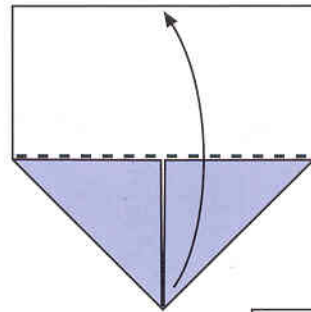

③ Fold the bottom corner up along the edge.

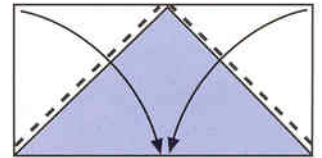

④ Fold the two corners down along the edges.

The completed
 RIGHT
 TRIANGULAR TILE

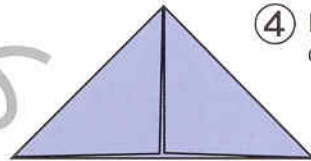
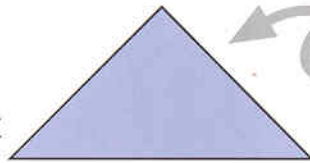

⑤ Turn the model over.

ISOSCELES TRIANGULAR TILE

にどうへんさんかっけい たいる
 2等辺3角形のタイル
 NI-TOU-HEN-SAN-KAK-KEI NO TA-1-RU

Start with a square piece of paper.

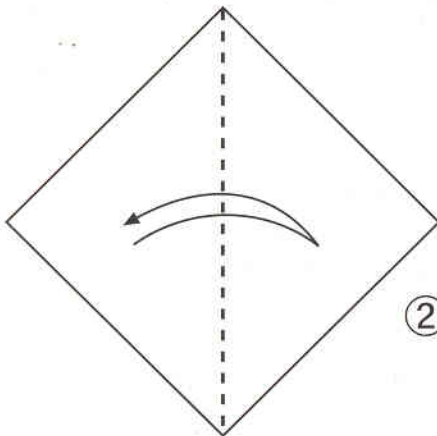

① Fold in half and unfold.

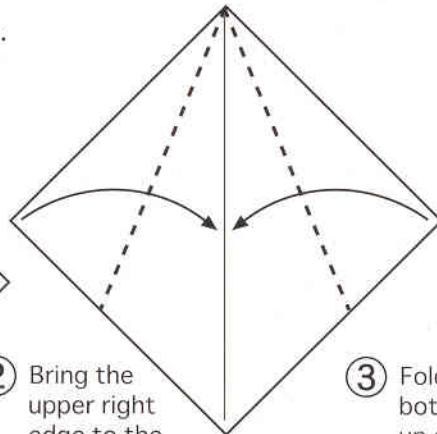

② Bring the upper right edge to the center line and fold. Do the same on the left side.

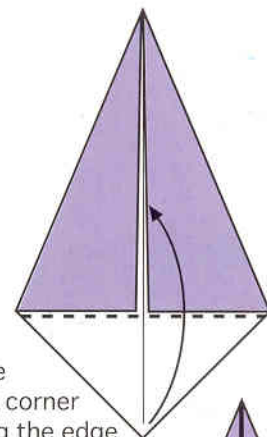

③ Fold the bottom corner up along the edge of the flaps as shown in the diagram.

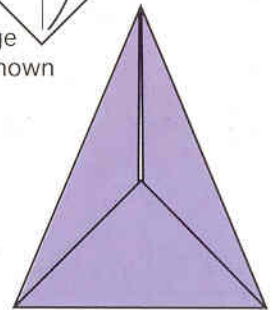

④ Turn the model over.

The completed
 ISOSCELES
 TRIANGULAR TILE

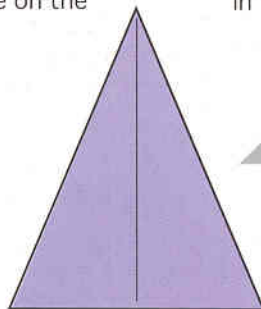

SQUARE TILE 2

せいほうけい たいるに
 正方形のタイル2
 SEI-HOU-KEI NO TA-I-RU NI

Start with a square piece of paper.

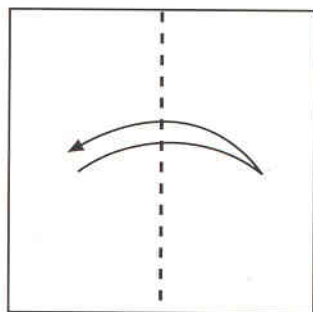

① Fold in half and unfold.

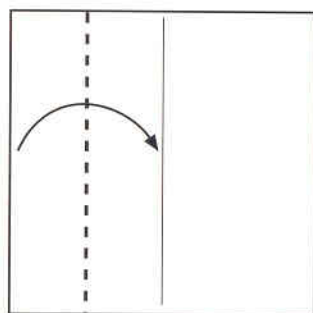

② Bring the left edge to the center line and fold.

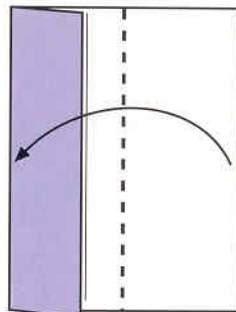

③ Bring the right edge to the left edge and fold.

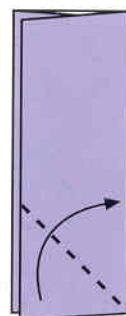

④ Bring the bottom edge of the top layer to the right edge and fold.

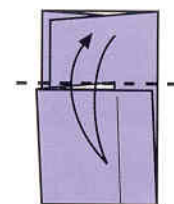

⑥ Fold along the edge and unfold.

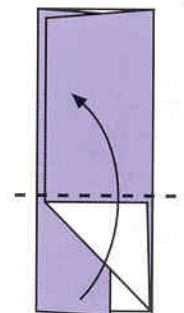

⑤ Fold along the edge.

⑦ Tuck the flap into the pocket.

RECTANGULAR TILE 2

ちようほうけい たいるに
 長方形のタイル2
 CHOU-HOU-KEI NO TA-I-RU NI

Start with a square piece of paper.

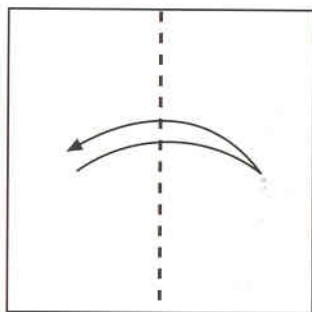

① Fold in half and unfold.

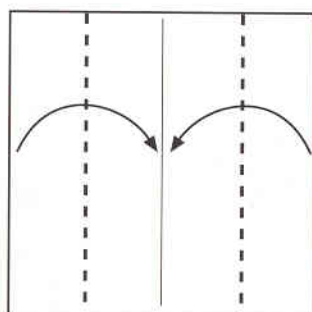

② Bring the left edge to the center line and fold. Do the same on the right side.

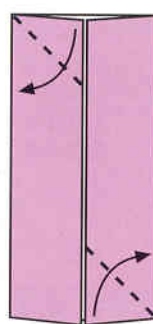

③ Fold only the upper layer.

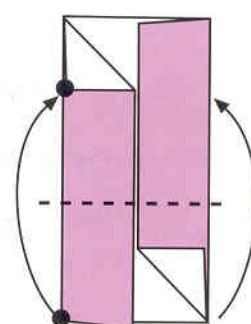

④ Bring the two points marked ● together and fold.

REGULAR OCTAGONAL TILE

せい は ち っ け い た い る
 正 8 角 形 の タ イ ル
 SEI-HACHI-KAK-KEI NO TA-I-RU

Start with a square piece of paper.

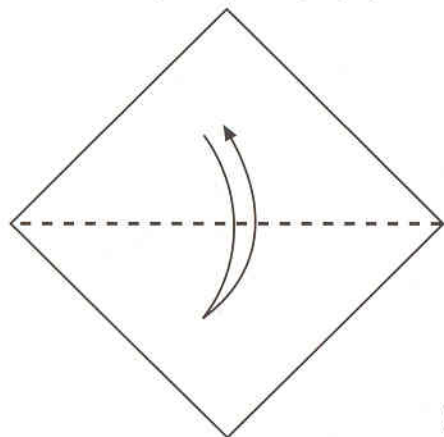

① Fold in half and unfold.

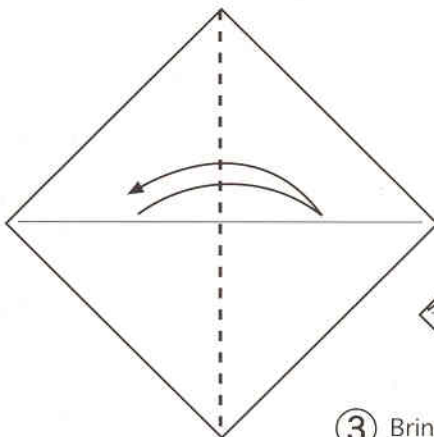

② Fold in half and unfold.

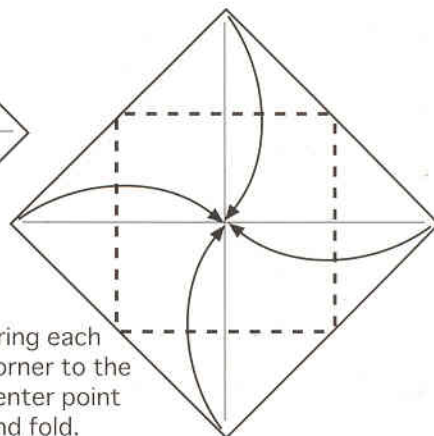

③ Bring each corner to the center point and fold.

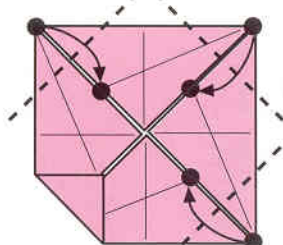

④ Fold only one layer and unfold.

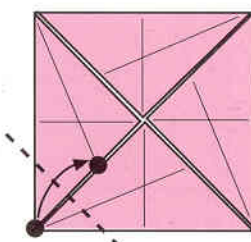

⑤ Bring the two points marked ● together and fold.

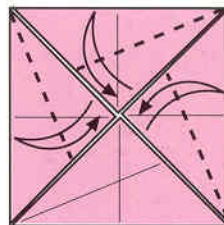

⑥ Do the same on the other three flaps.

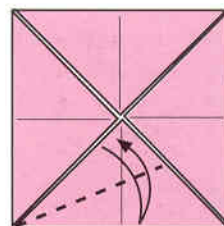

⑦ Fold only one layer and unfold.

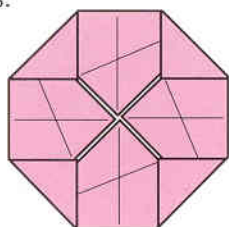

⑧ Turn the model over.

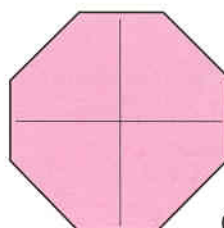

The completed
 REGULAR
 OCTAGONAL TILE

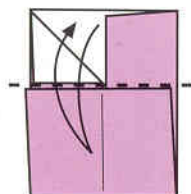

⑤ Fold along the edge and unfold.

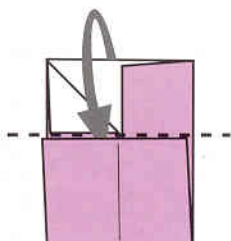

⑥ Tuck the flap into the pocket.

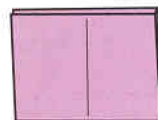

The completed
 RECTANGULAR TILE 2

EQUILATERAL TRIANGULAR TILE

せいざんかけい たいる
正3角形のタイル
SEI-SAN-KAK-KEI NO TA-I-RU

Start with a square piece of paper.

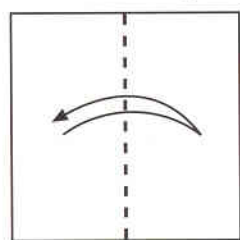

① Fold in half and unfold.

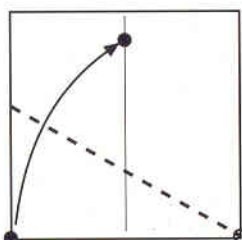

② Bring the lower left corner to the center line and fold. Make sure the fold goes through the lower right corner.

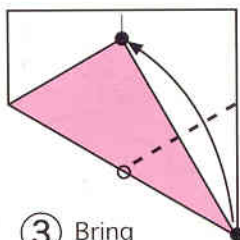

③ Bring the two points marked ● together and fold.

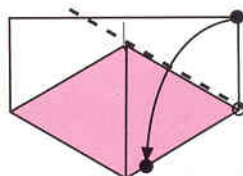

④ Fold along the edge.

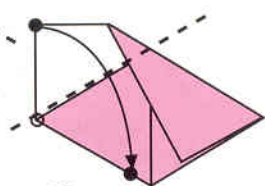

⑤ Fold along the edge.

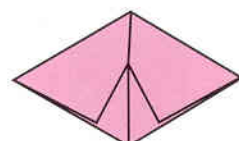

⑥ Unfold back to a square.

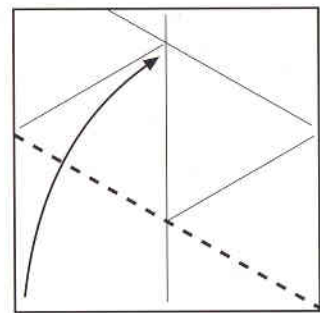
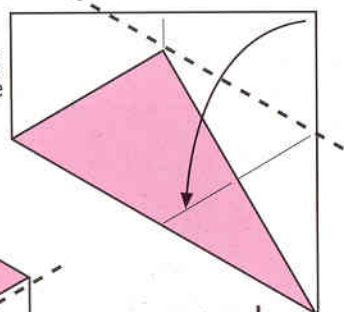

⑧ Fold along the crease line.

⑦ Fold along the crease line.

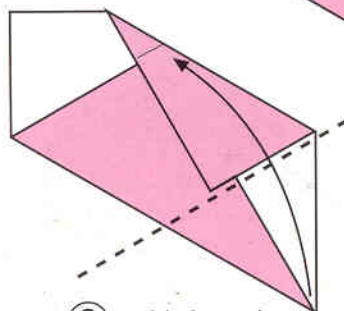

⑨ Fold along the crease line.

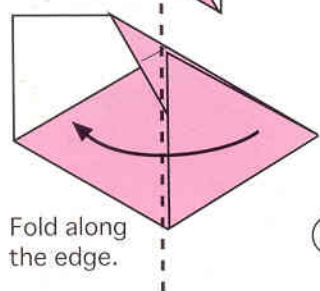

⑩ Fold along the edge.

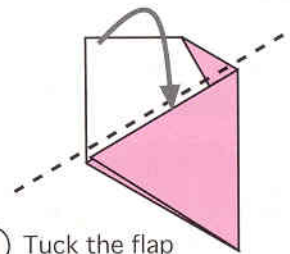

⑪ Tuck the flap into the pocket.

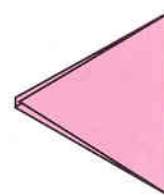

The completed EQUILATERAL TRIANGULAR TILE

RHOMBIC TILE

がた たいる
ひし形のタイル
HI-SHI-GATA NO TA-I-RU

You need a square piece of paper. Start from step ⑦ in the above diagrams.

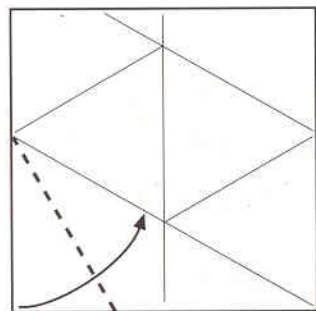

⑦ Bring the left edge to the crease line and fold.

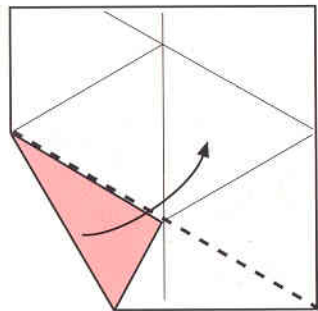

⑧ Fold along the crease line.

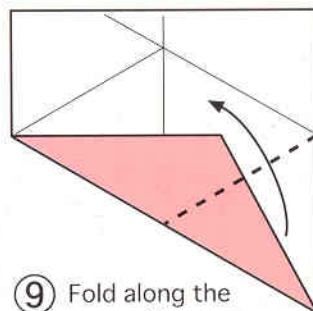

⑨ Fold along the crease line.

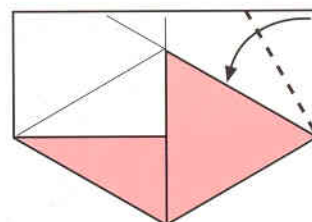

⑩ Bring the right edge to the upper edge of the top layer and fold.



REGULAR HEXAGONAL TILE

せいりっかけい たいる
正六角形のタイル
SEI-ROK-KAK-KEI NO TA-I-RU

Start with a square piece of paper.

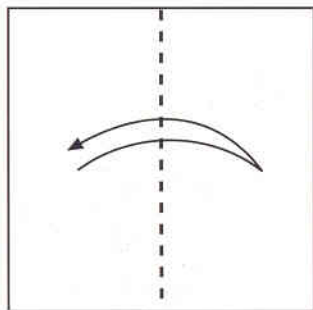

① Fold in half and unfold.

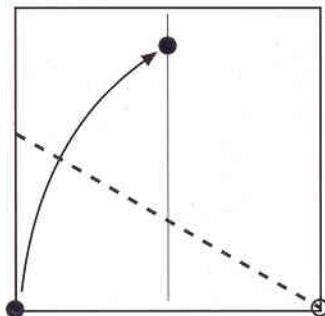

② Bring the lower left corner to the center line and fold. Make sure the fold goes through the lower right corner.

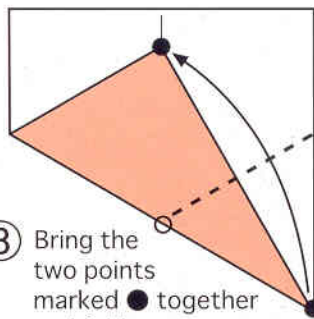

③ Bring the two points marked ● together and fold.

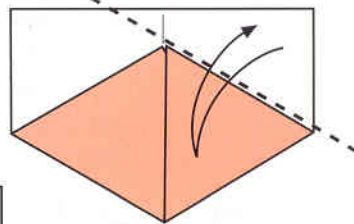

④ Fold along the edge and unfold.

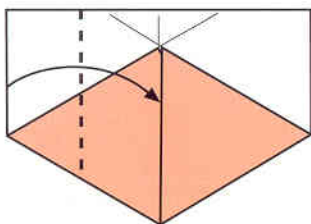
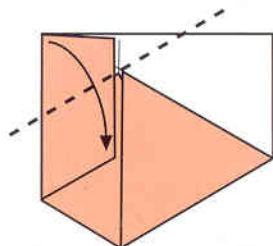

⑥ Bring the left edge to the center line and fold.

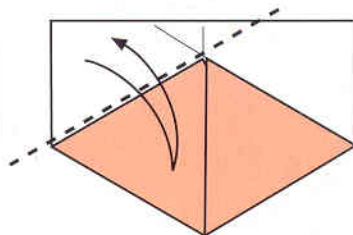

⑤ Fold along the edge and unfold.

⑦ Fold along the crease line.

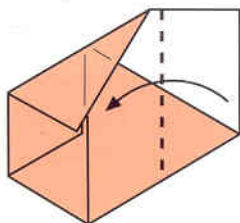

⑧ Bring the right edge to the center line and fold.

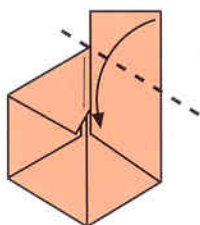

⑨ Fold along the crease line.

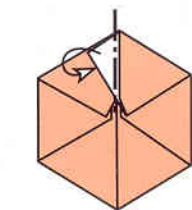

⑩ Tuck the flap under the layer.

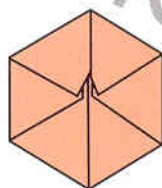

⑪ Turn the model over.

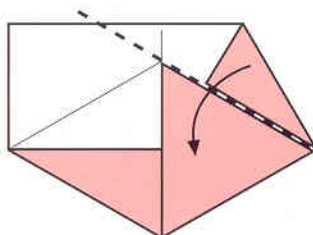
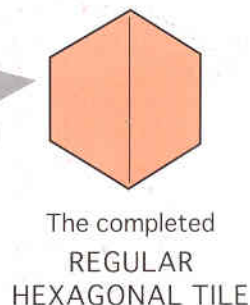

⑪ Fold along the crease line.

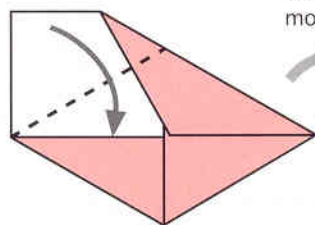

⑫ Fold along the crease line and tuck the flap under the layer.

Turn the model over

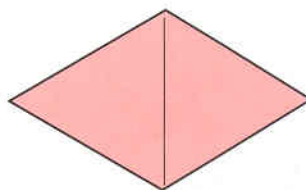

REGULAR PENTAGONAL TILE

せいごかけい たいる
正五角形のタイル
SEI-GO-KAK-KEI NO TA-I-RU

Start with a square piece of paper.

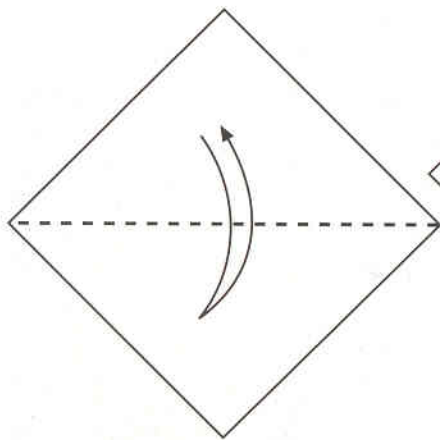

① Fold in half and unfold.

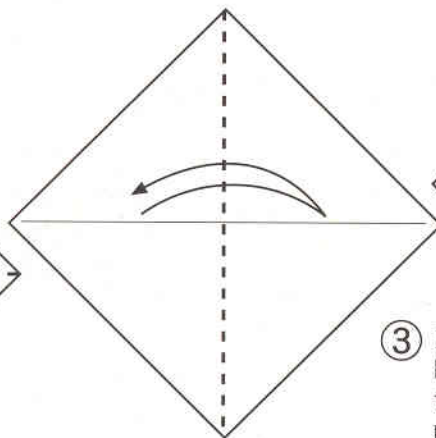

② Fold in half and unfold.

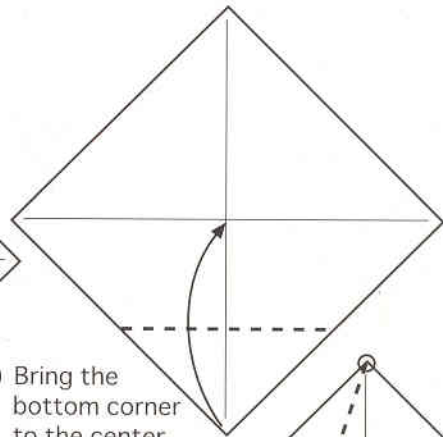

③ Bring the bottom corner to the center point and fold.

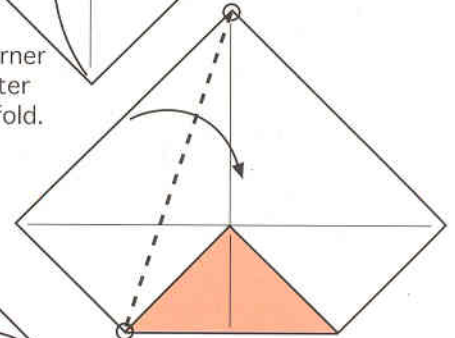

④ Fold along the line connecting the top corner with the lower left corner.

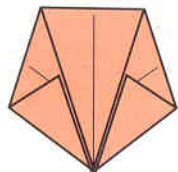

⑧ Unfold back to a square.

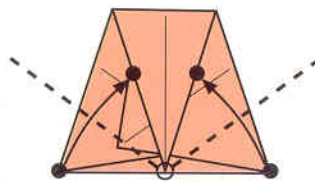

⑦ Bring the bottom right edge to the right edge of the upper layer and fold. Do the same on the left side.

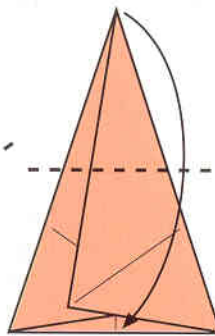

⑥ Bring the top point to the center of the bottom edge and fold.

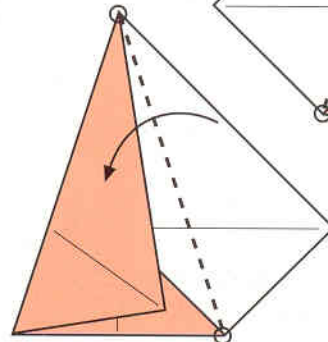

⑤ Do the same on the right side.

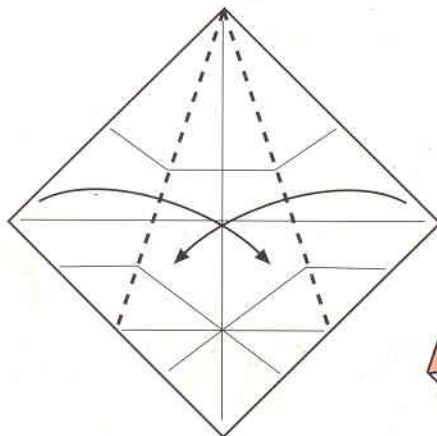

⑨ Fold along the two crease lines.

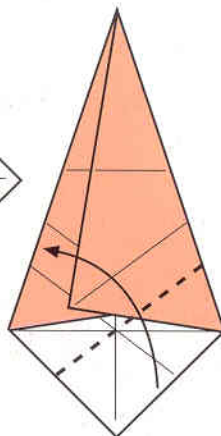

⑩ Fold along the crease line.

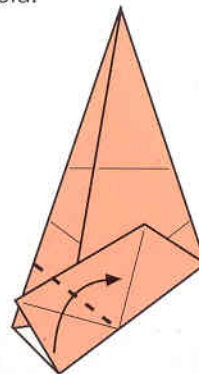

⑪ Fold along the crease line.

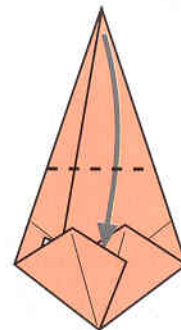

⑫ Fold along the crease line and tuck the top point into the pocket.

The completed
REGULAR
PENTAGONAL TILE

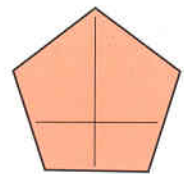

Turn the model over

Arrangements of Tiles

You can use tiles to decorate other projects, too!

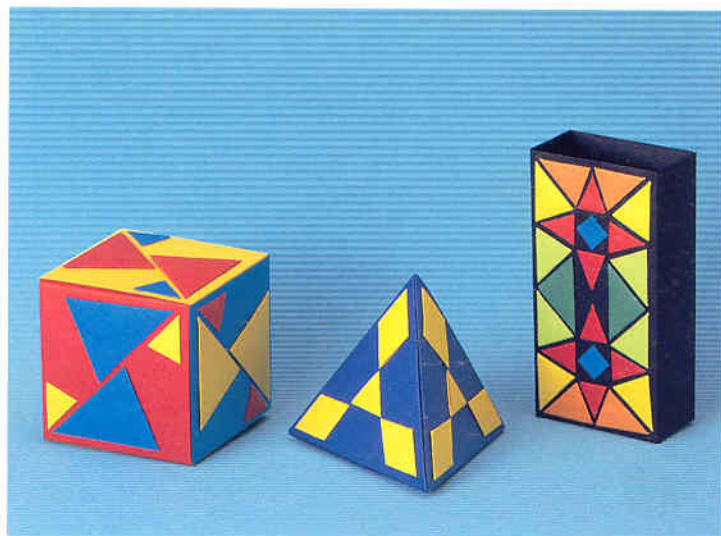

POLYGON

た かけい
多角形
TA-KAK-KEI

- A polygon is a kind of 2-D structure with some number of connected straight lines (edges) and corners (vertices).
- A polygon has some number of vertices, edges and only one face. The inside of the face is called the interior, and the outside is the exterior.
- A regular polygon is a flat structure with edges of equal length and vertices with the same included angle.
- There are an infinite number of regular polygons.

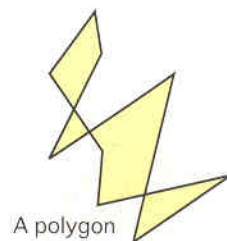
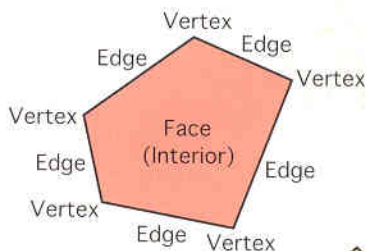

A polygon

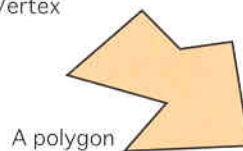

A polygon

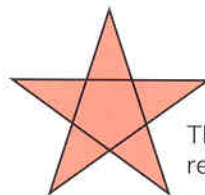

This is also a regular polygon.

Regular Stellated Pentagon

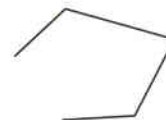

Not a polygon
(This cannot be a face)



Equilateral Triangle

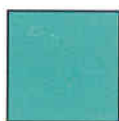

Square

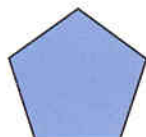

Regular Pentagon

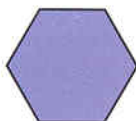

Regular Hexagon



Regular Heptagon



Regular Octagon



Regular Enneagon



Regular Decagon



polyhedron origami for beginners

An innovative approach to origami craft, polyhedron origami introduces you into a new world of many-sided solid figures. This book is a comprehensive collection of polyhedron origami from tetrahedron to icosahedron. Each solid object is formed from simple folded units. Each process is illustrated with clear step-by-step diagrams for beginners. Start with simple works such as tiles, bricks, prisms, pyramids, cubes and then follow the advanced courses, which include regular polyhedrons, tetrahedrons, octahedrons, dodecahedrons and so on. A variety of stars, flutter wheels and windmills are also presented as applications. It is not an easy task to make many units, but the joy and gratification are great when the works are completed. They reward the effort.

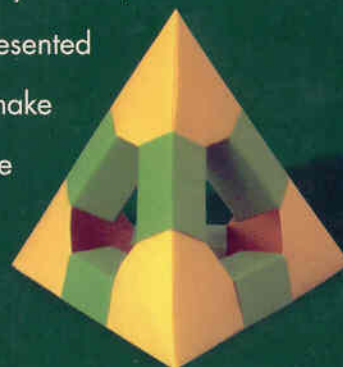

ISBN 4-88996-085-6



Nihon Vogue-sha/Japan Publications
Printed in Japan \$19.00 U.S.