

Contents

Preface	page v	DRACULA 3	44
Introduction	1	DOG BARKING	45
Essential Advice	4	SWIMMER	46
A Note on Symbols	7	RABBIT	48
Symbols	8	PENGUIN	50
		GOOSE	51
		THREE PIECE	
		JUMBO	52
<i>Procedures</i>		MAPLE LEAF	55
Use of Symbols	9	BABY DRAGON	56
Quick Bases	10	OSTRICH	58
Squash Folds	11	MOUNT FUJI	61
Petal Folds	12	SUPER BOX	62
Reverse Folds	13	GLIDING TOY	64
Rabbits' Ears	14	SHERLOCK HOLMES	65
Crimps	15	SMUGGLER'S WALLET	68
Sinking	16	WALRUS	70
LETTER FOLD	17	HUMMING BIRD	72
CARNIVAL HAT	18	SWAN	74
DISH	19	SIAMESE CAT	76
TED HEATH	22	ELEPHANT	77
MAN FROM MARS	23	HAT	82
VALENTINE	24	BABY GRAND	83
GLIDER	25	BABY PENGUIN	88
FOTOPURSE	26	MATCHBOX	89
ASH TRAY	27	OLYMPIC TORCH	92
SYCAMORE SEED	28	FLAPPING BIRD	95
OWLIGAMI	30	ROSE	96
OWL	32	ESCHER	98
FLYING SPARROW	34	BABY CHICK	100
LOCH NESS		BUDDAH	101
MONSTER	36	TURTLE	104
CHRISTMAS		BUDDAH ON A	
ORNAMENT	37	TORTOISE	106
BALL IN A BALL	38	BUDDAH SEATED	108
KING OF SPADES	40	SHRINE OF	
DRACULA 1	42	BUDDAH	110
DRACULA 2	43	VIKING LONGSHIP	112

TANK	114	BLUE WHALE	149
PALM TREE	116	RED INDIAN	150
GOOD DOG	118	MARLIN	152
TRI-STAR	120	BUDDAH DISPLAY	154
DIAMOND	122	SQUIRREL	156
ONBERON	123	PICTURE FRAME	158
LET'S DANCE	128	FOUR ROSES	159
SQUARE OWL	131	ANCHOR	162
CHICK HATCHING	132	OCEAN LINER	164
SIESTA	134	LEAF	166
DECORATION	136	LETTER	167
PERSIAN HORSE	137	ANGEL FISH	168
LION RECLINING	140	PYRAMID	170
HELMET	142	FLIP-TOP	171
HELL CAT	143	BOOK	174
POLYHEDRAL BOX	144	TIPPER TRUCK	176
POST A LETTER	146	MATCHBOX 2	180
CUPID	148	LIZARD	182

INTRODUCTION TO ORIGAMI 4

With the preparation of each new volume in the *Origami* series, Robert Harbin provides us with an opportunity to look at the changing origami scene and take stock. What, then, has been happening since the publication of *Origami 3* in 1972?

Firstly, within a month or two of that book's appearance, the Japanese folder Akira Yoshizawa made a government sponsored visit to Britain and provided British folders with a chance to study a Japanese master at work. More of that later.

The following year saw the birth in Japan of the Nippon Origami Association, a body which subsequently organised the *First International Origami World Fair* which was held in Kyoto in 1976. Contributors to this book were among the folders from many nations whose work could be seen there.

In 1973, too, several courses in origami were started for the first time at Institutes of Adult Education in Britain, the first being organised by Mick Guy in Birmingham. Another 'first' of that year was the animated origami sequence, designed by Robert Harbin, which formed part of the television play, *Tobias and the Angel*, screened on BBC TV during Christmas week. This specialised use of origami had been seen in Japan previous-

Procedures Sinking

this means sink

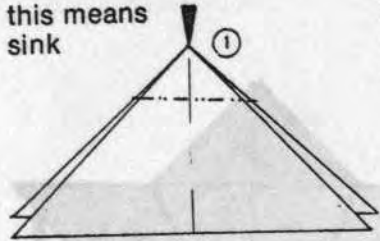

some of many examples

crease behind

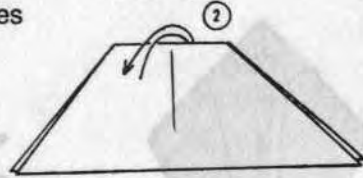

crease in front

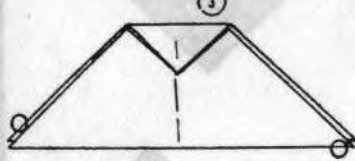

hold open out push in

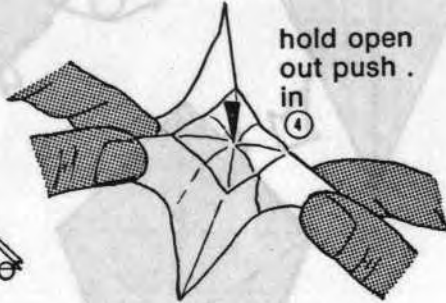

like this

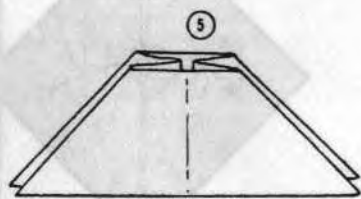

or this

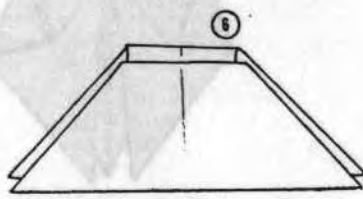

treat in the same way

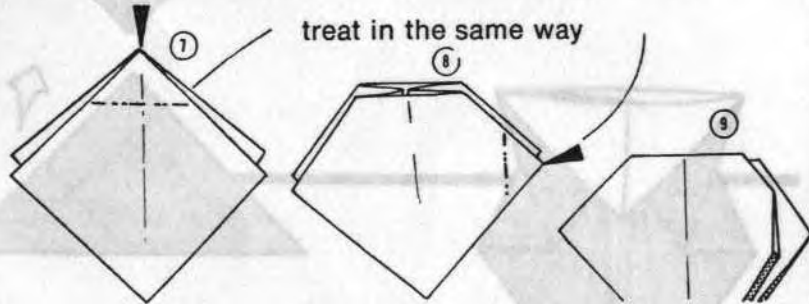

Letter Fold Guiseppe Baggi

Italy

use a rectangle
write your letter
then fold

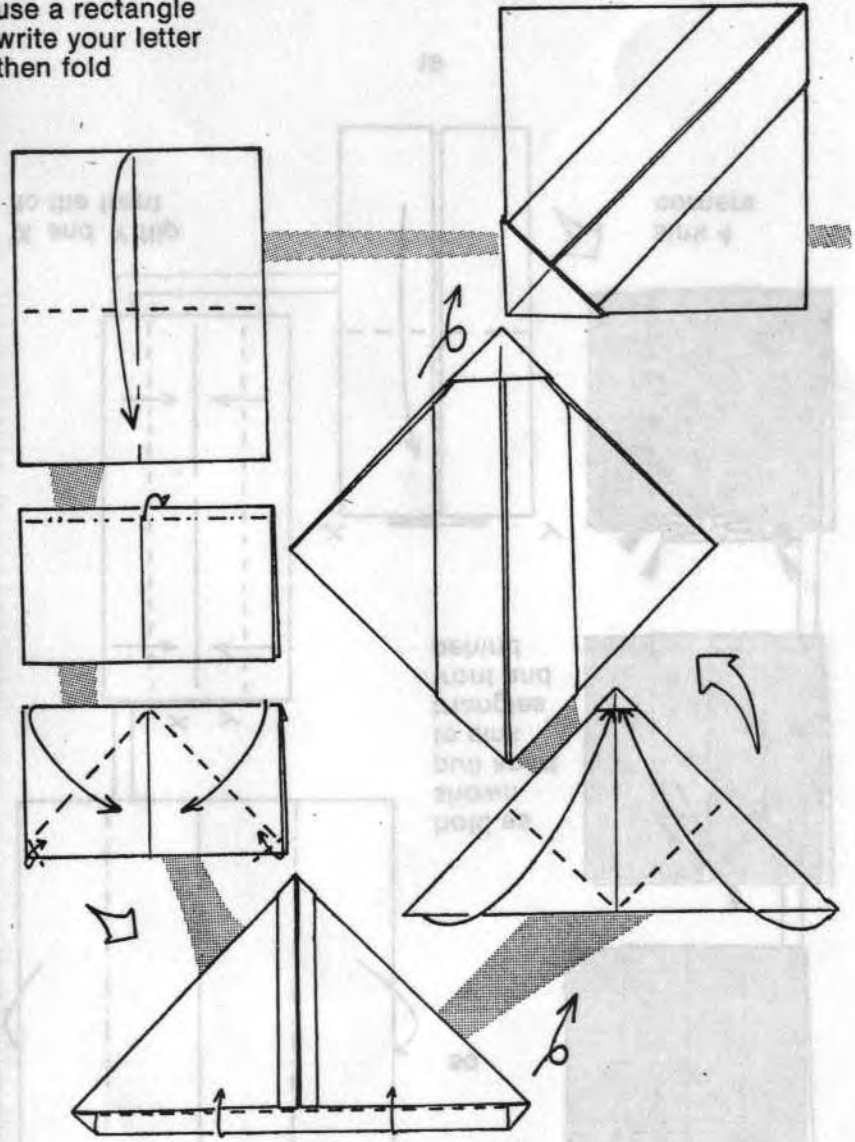

Carnival Hat Robert Harbin

Gt. Britain

use a square
coloured one
side

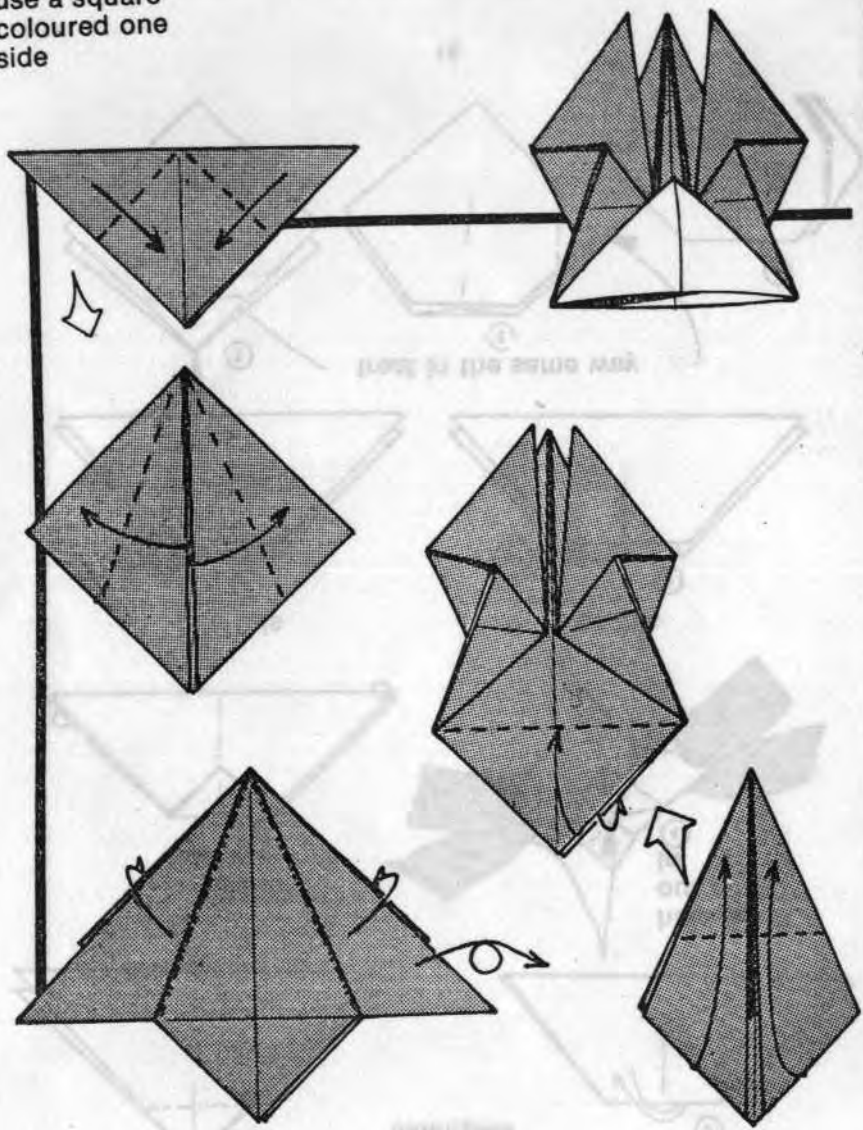

Dish Eric Kenneway An Exercise Gt. Britain

white side up

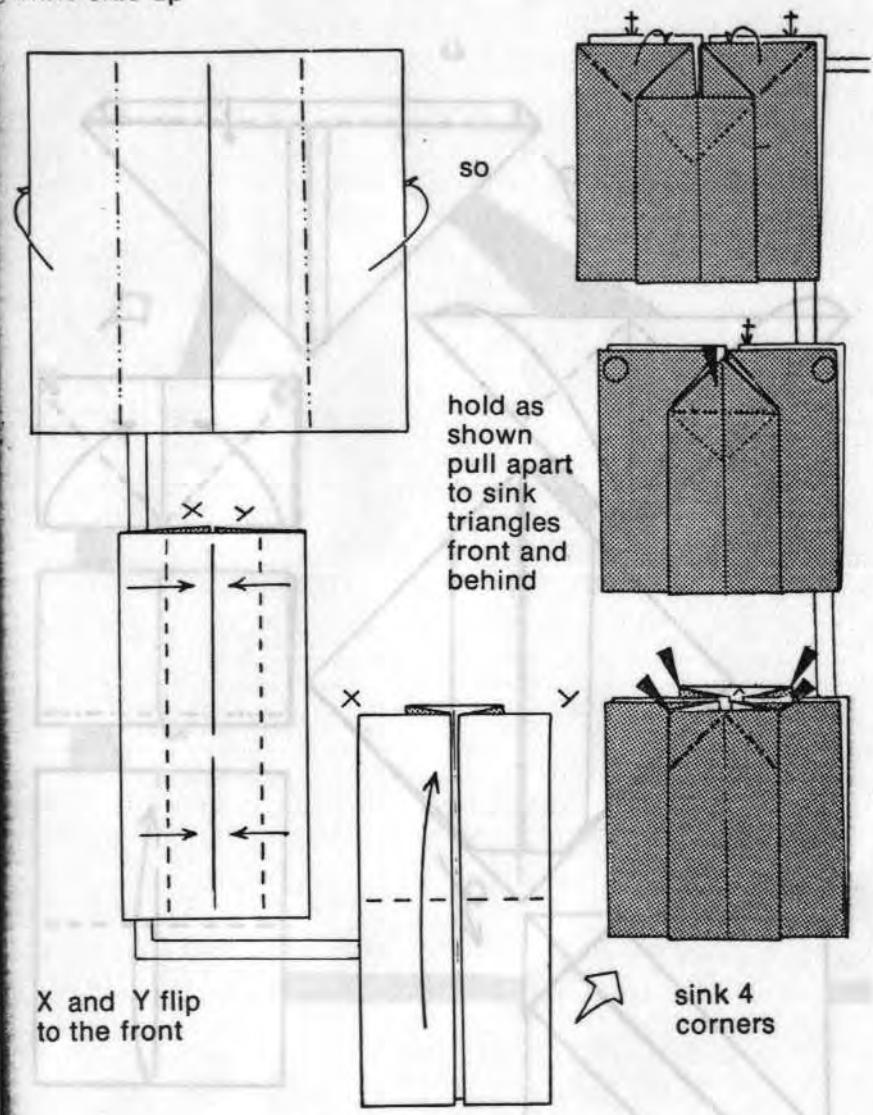

so

hold as
shown
pull apart
to sink
triangles
front and
behind

X and Y flip
to the front

sink 4
corners

Dish continued Watch those Symbols

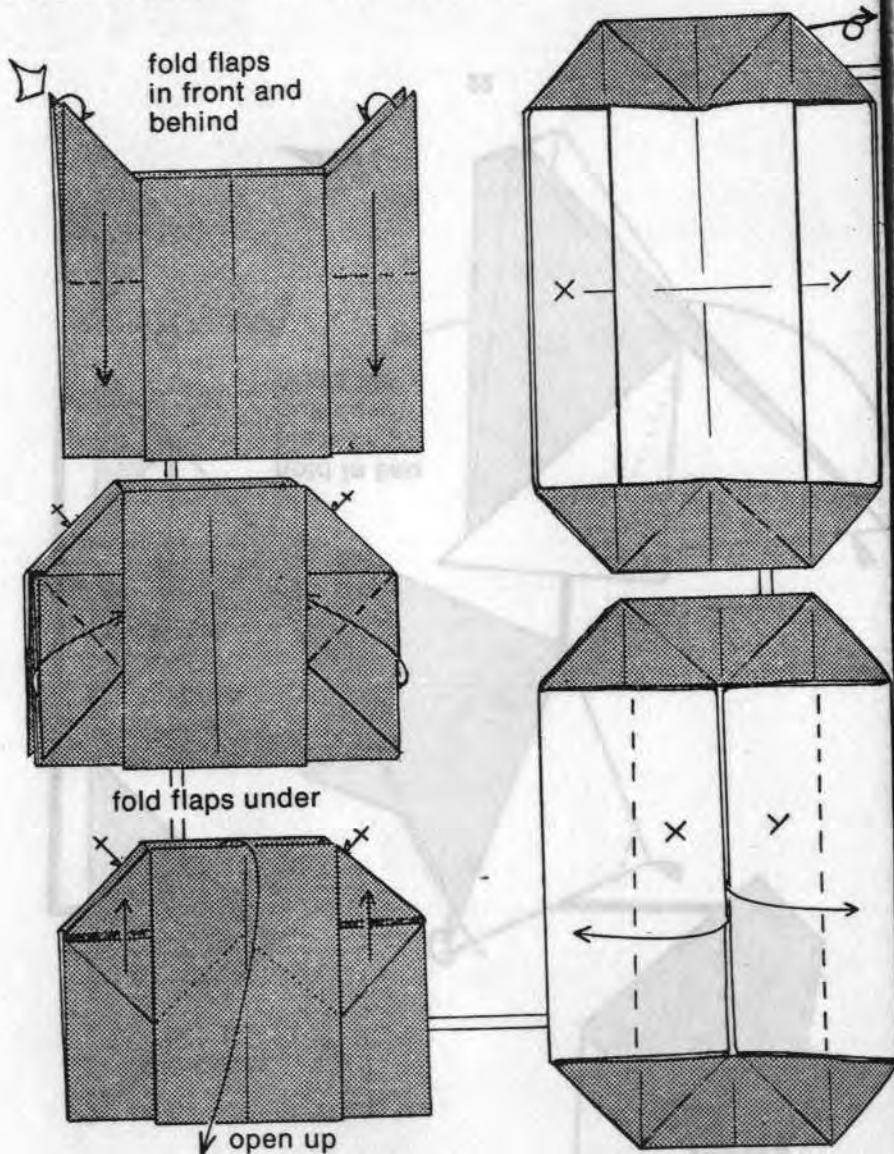

Dish concluded Very Strong Model

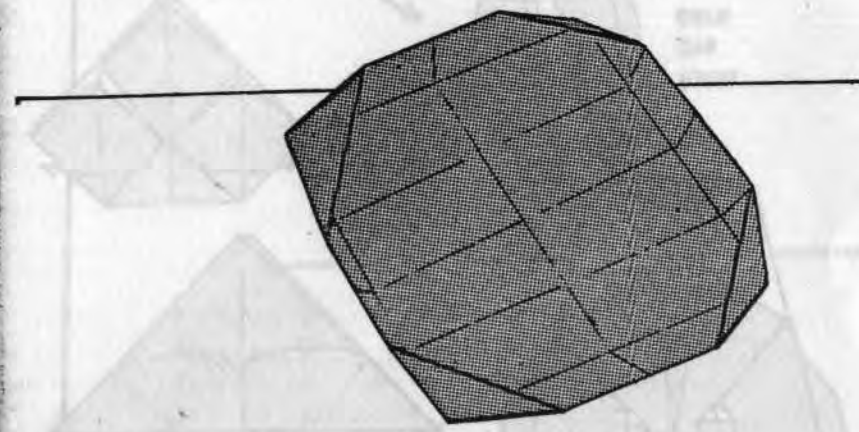
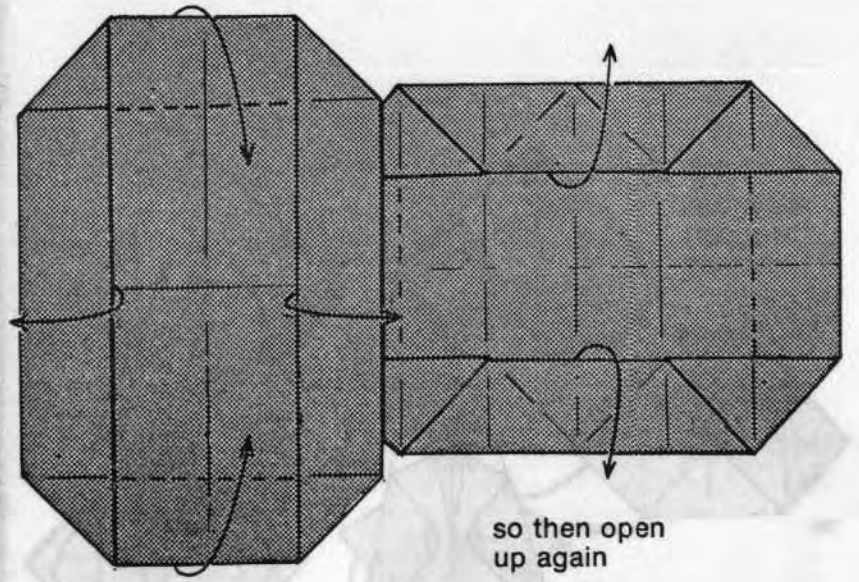

Ted Heath Eric Kenneway

Gt. Britain

use a square pink
one side to make
this fine caricature

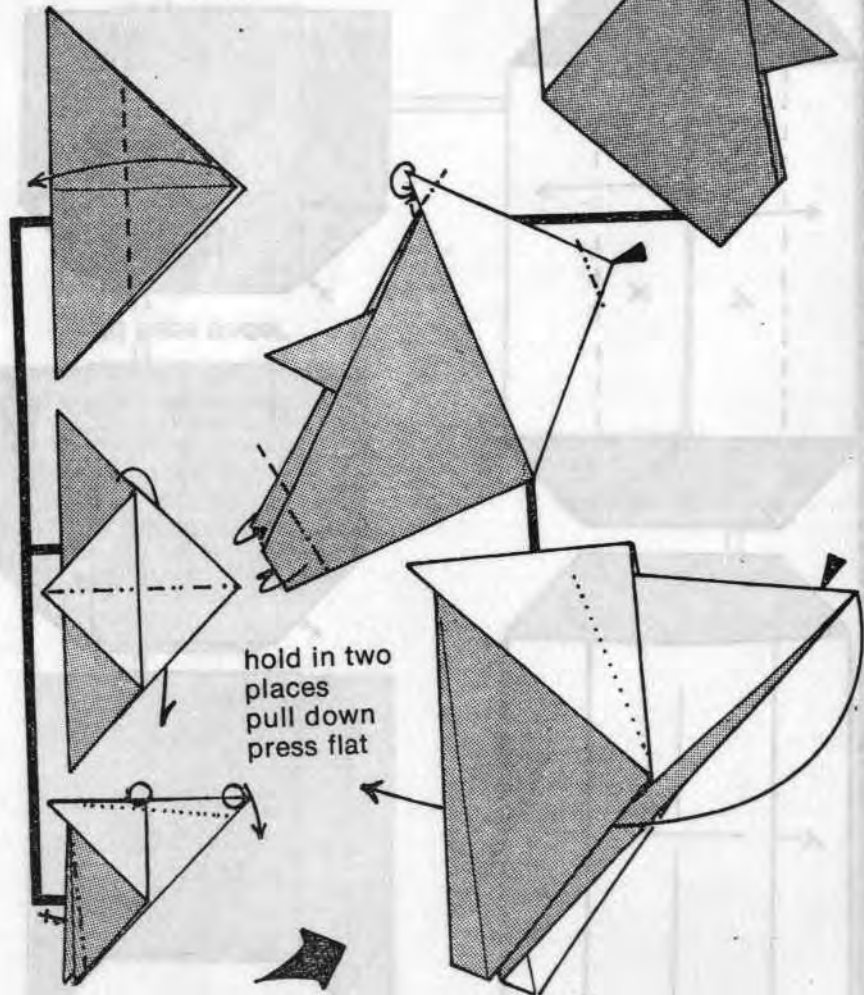

hold in two
places
pull down
press flat

Man from Mars Albert W. Allen

U.S.A.

a square green one
side diagonals creased
make two squash folds
(inspired by Eric Kenneway)

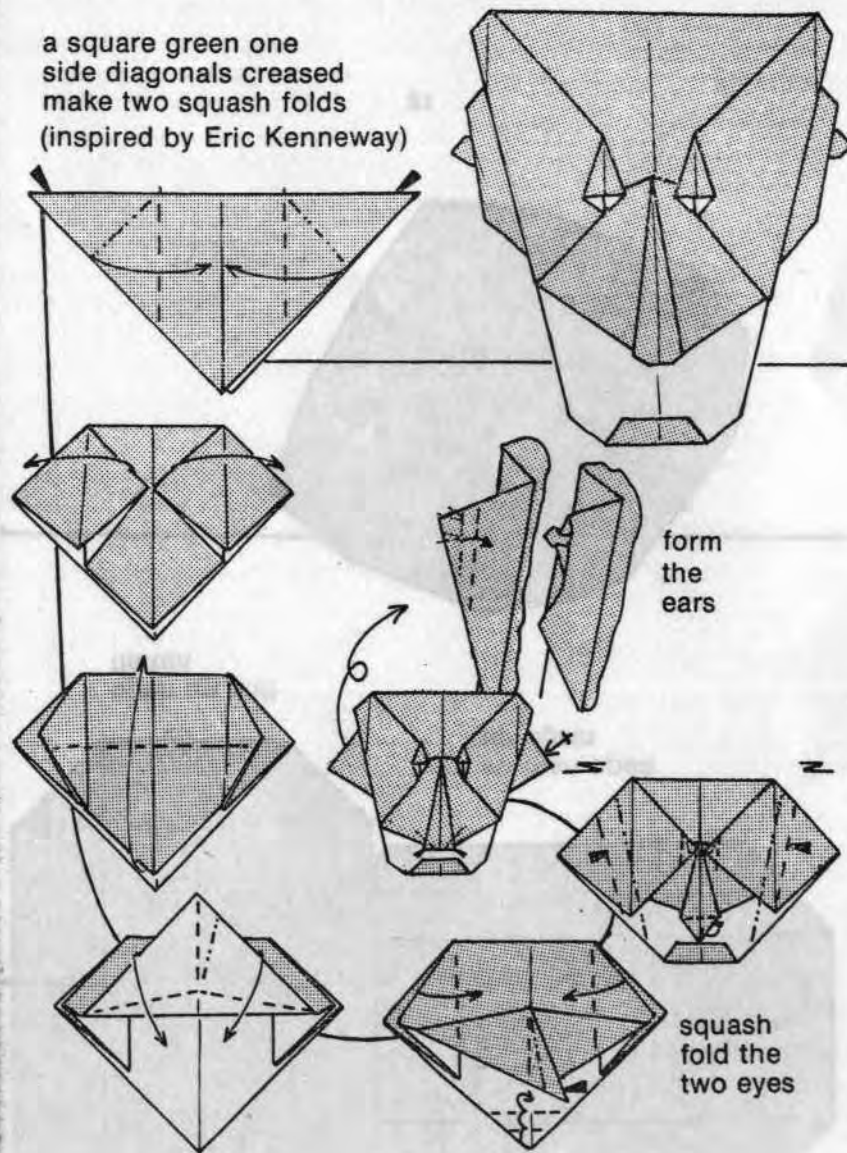

form
the
ears

squash
fold the
two eyes

Valentine Alice Gray

use a square red
one side, crease
diagonals

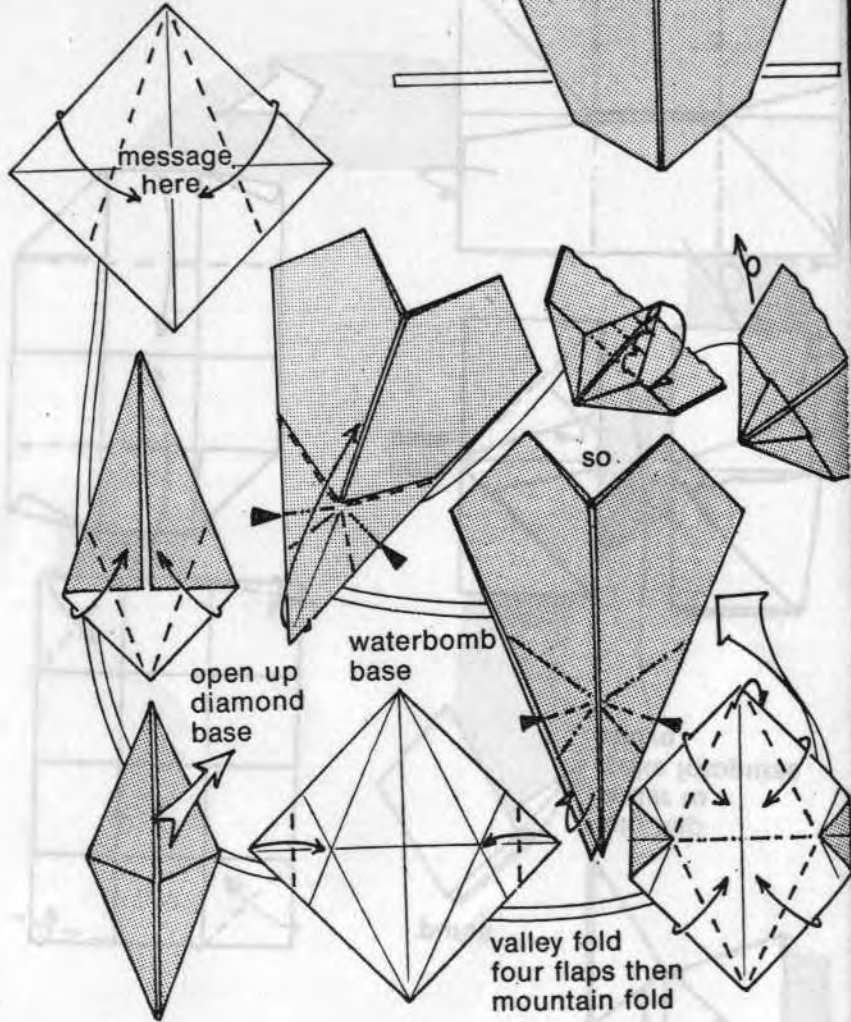

U.S.A.

Glider C. Plowman (age 14)

Gt. Britain

use a square
crease as shown
make valley folds

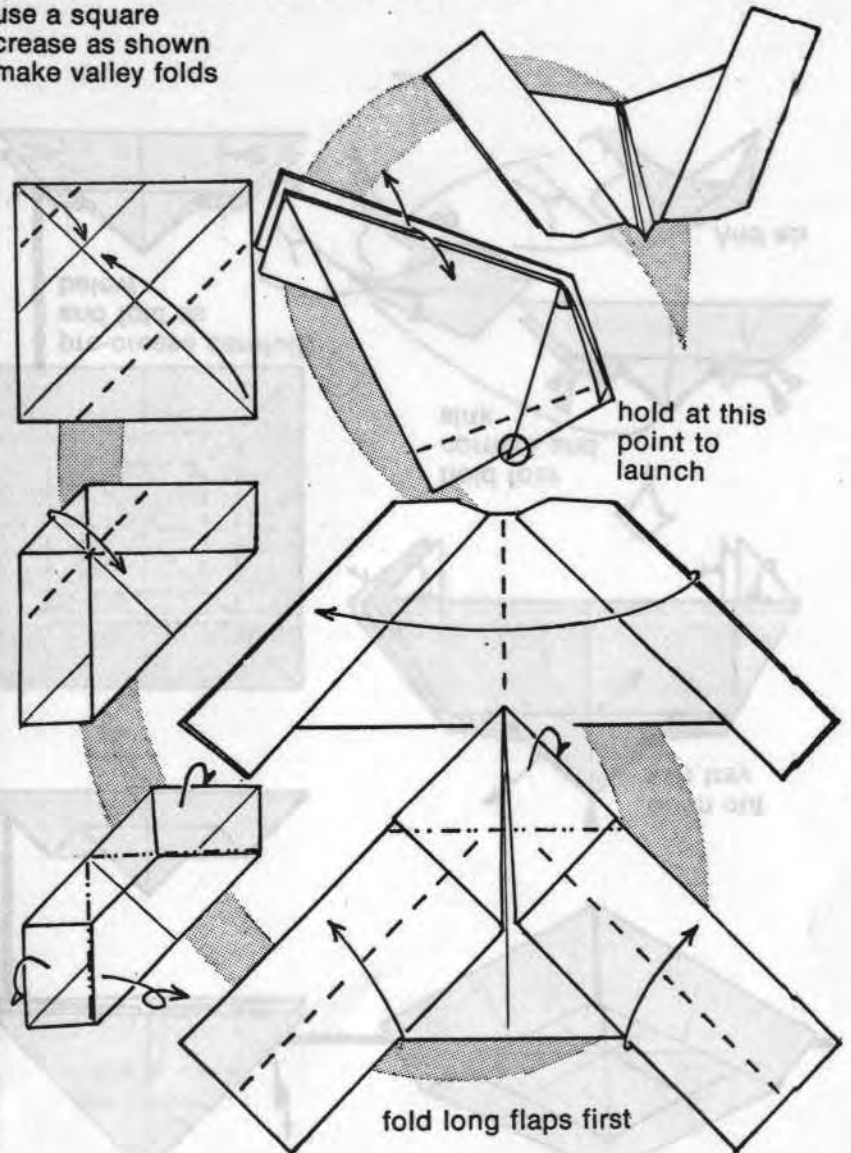

Fotopurse John Cunliffe

writing paper A3 or
350 x 250 millimetres

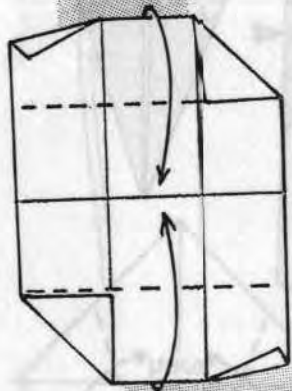
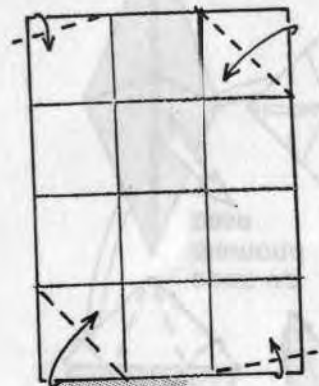

purse

fold flap
under to
make fotopurse
above



note
case

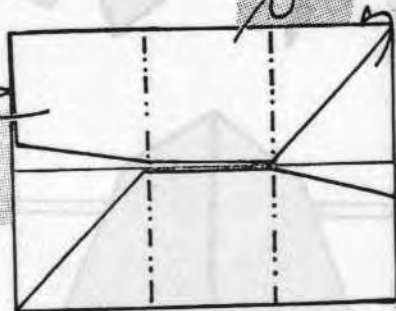
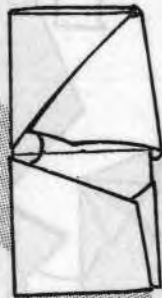

Gt. Britain

Ash Tray Ronald Koh

Singapore

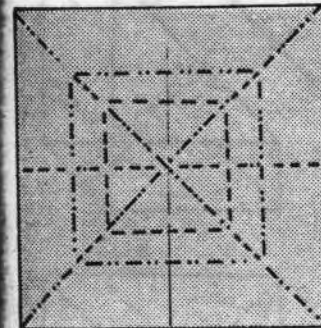
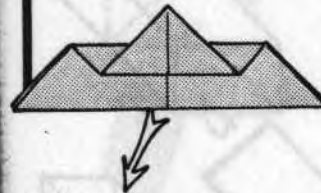

pre-crease carefully
and fold as
below

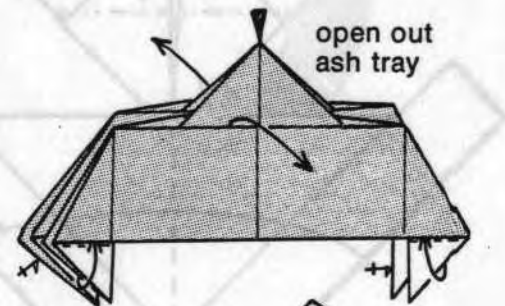
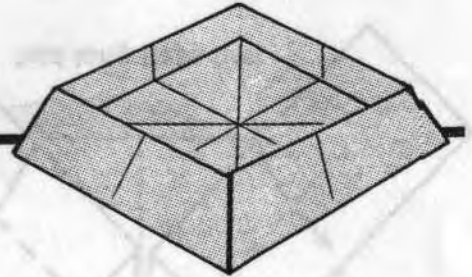

open out
ash tray

hold four
corners and
sink

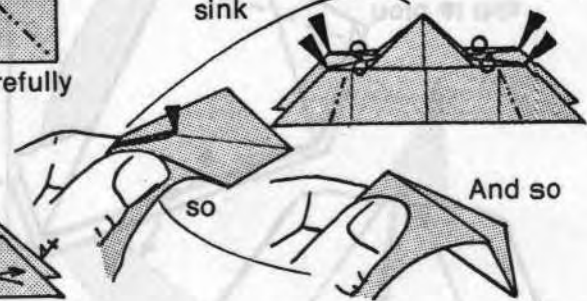

so

And so

Sycamore Seed John S. Smith Gt. Britain

use a rectangle of cartridge paper 375mm × 250mm

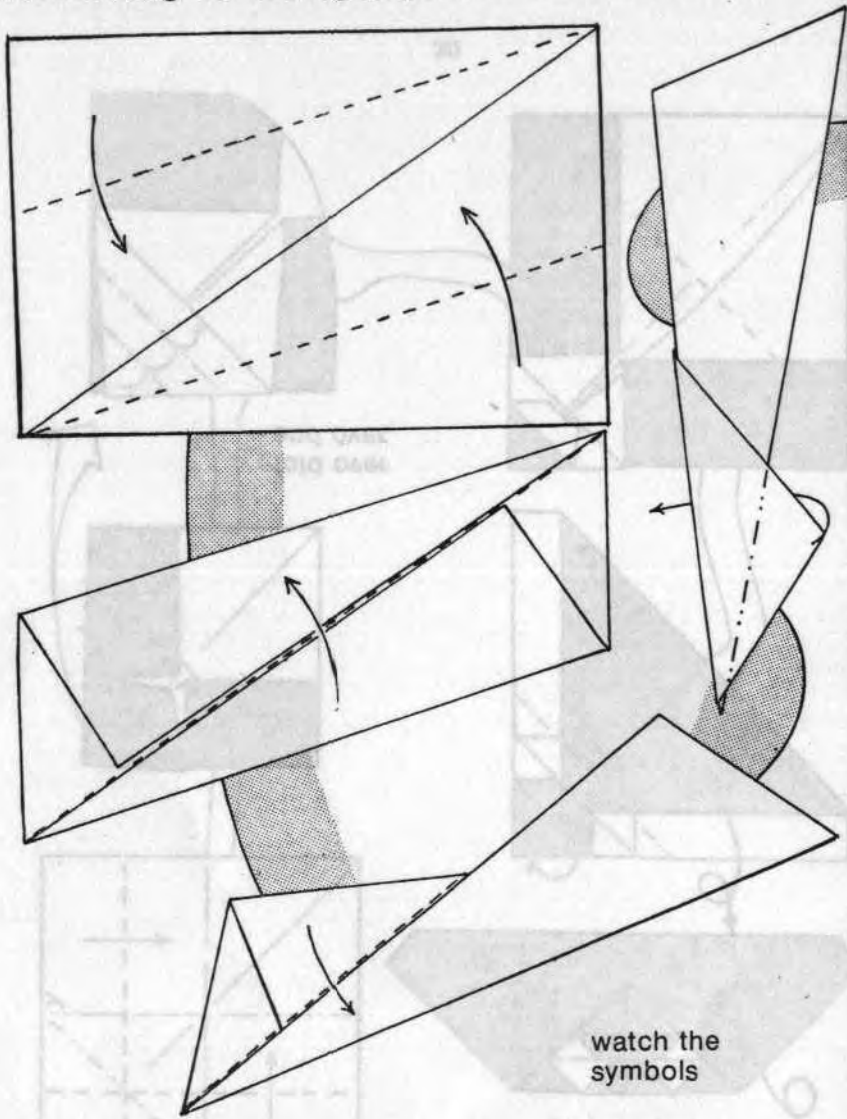

28

Sycamore Seed concluded

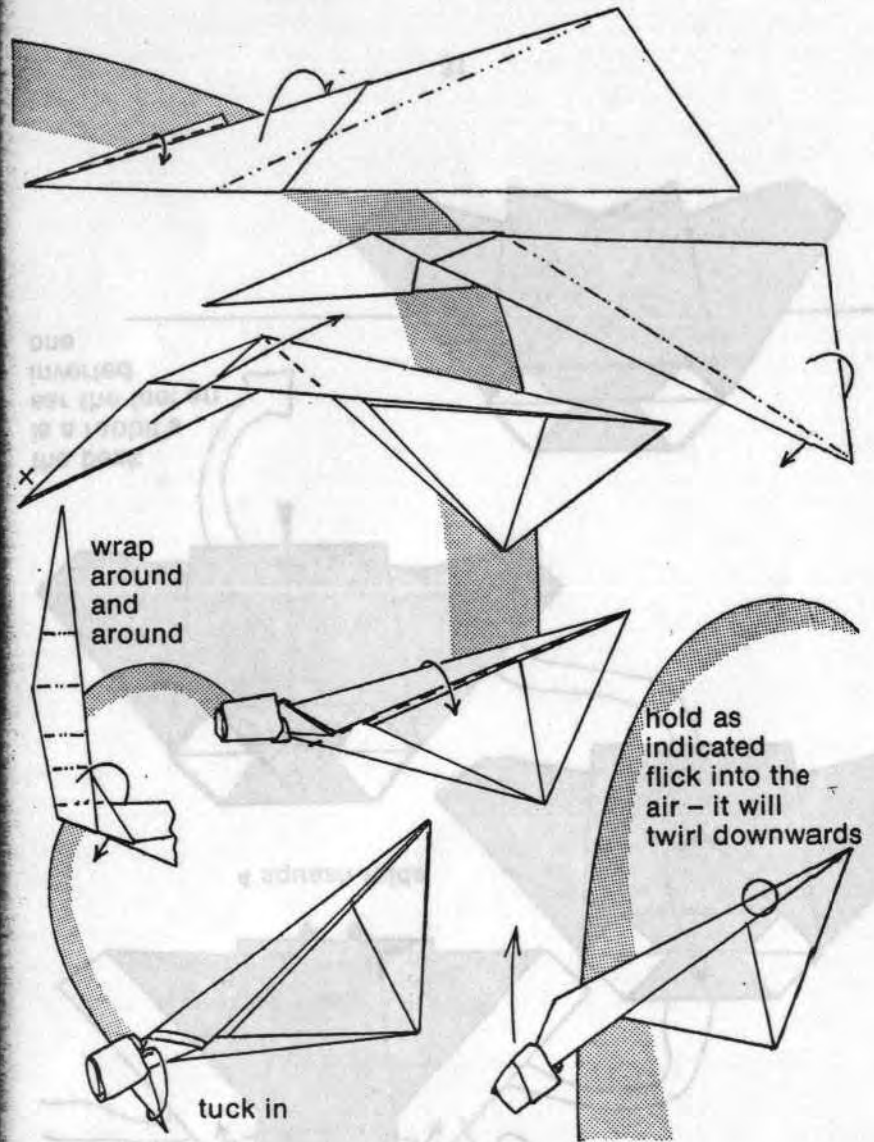

29

Owligami Edward Megrath

Gt. Britain

brown square white side up

crease A then make folds

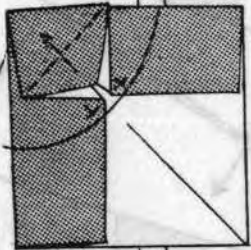
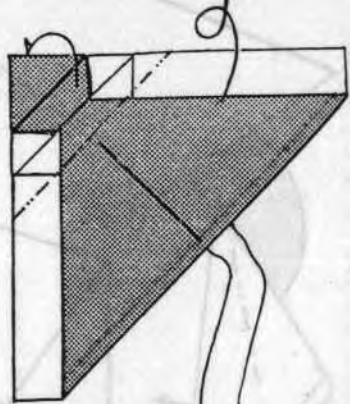
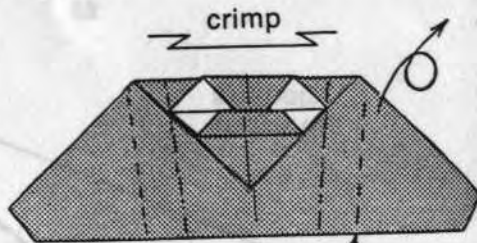
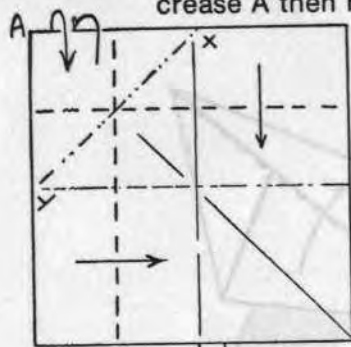

fold over
and over

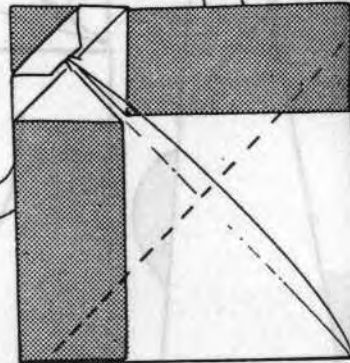
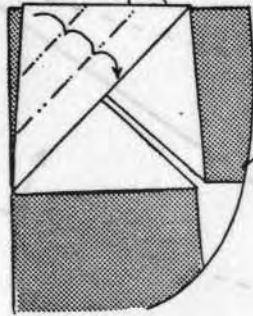

30

Owligami concluded (Rabbits' Ears page 14)

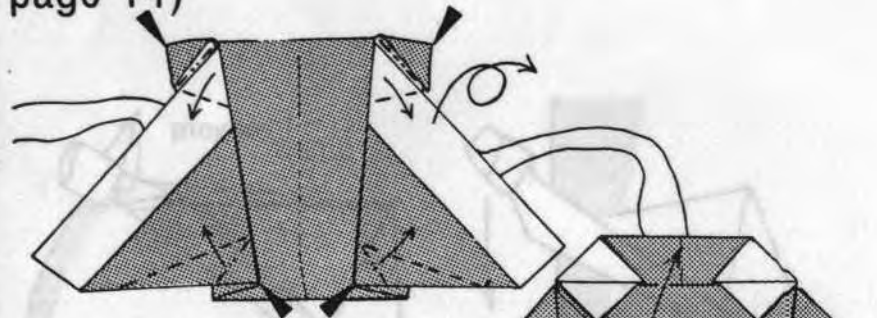

4 squash folds

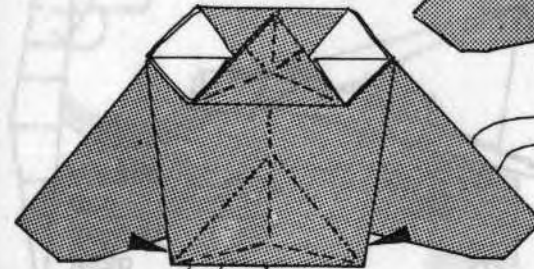

the beak
is a rabbit's
ear the feet an
inverted
one

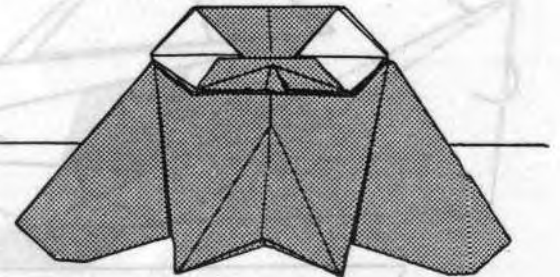

31

Owl John Richardson

use a square folded
off-centre as shown

Gt. Britain

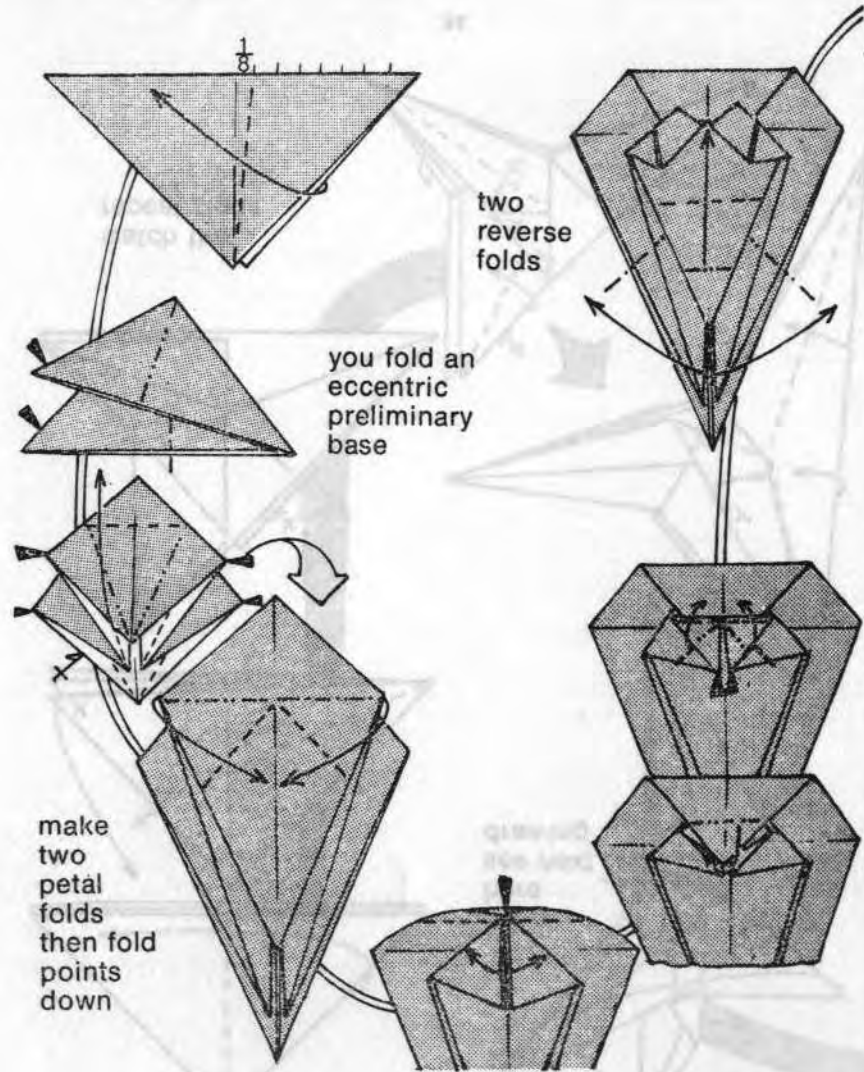

32

Owl concluded

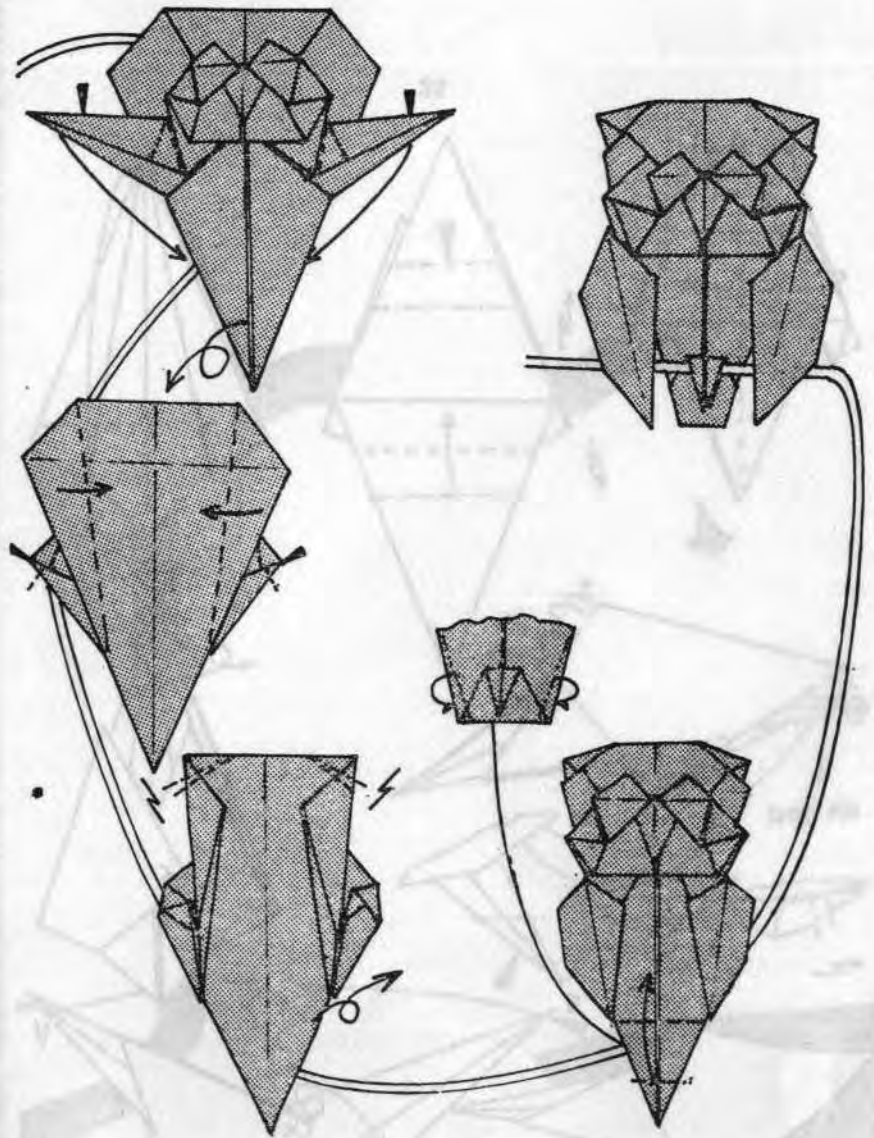

33

Flying Sparrow Toshie Takahama Japan

Flying Sparrow The Wings also fold back

begin with a waterbomb base

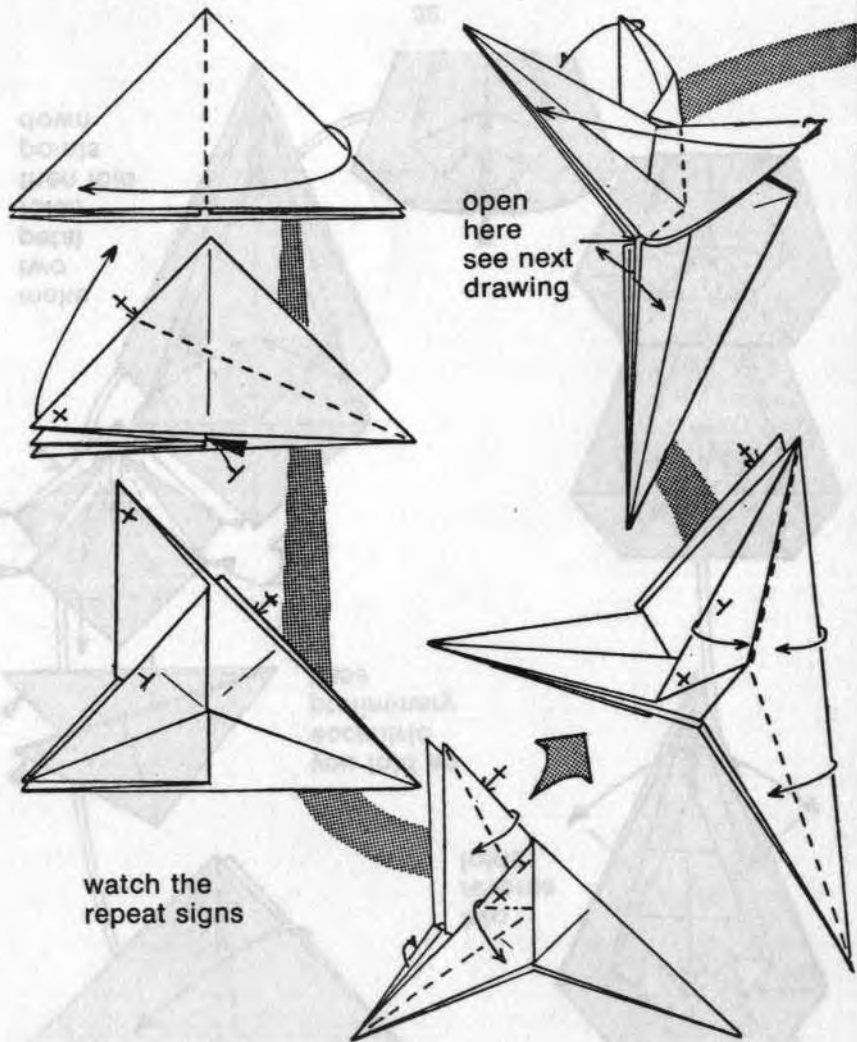

open here see next drawing

watch the repeat signs

open out middle A and B meet

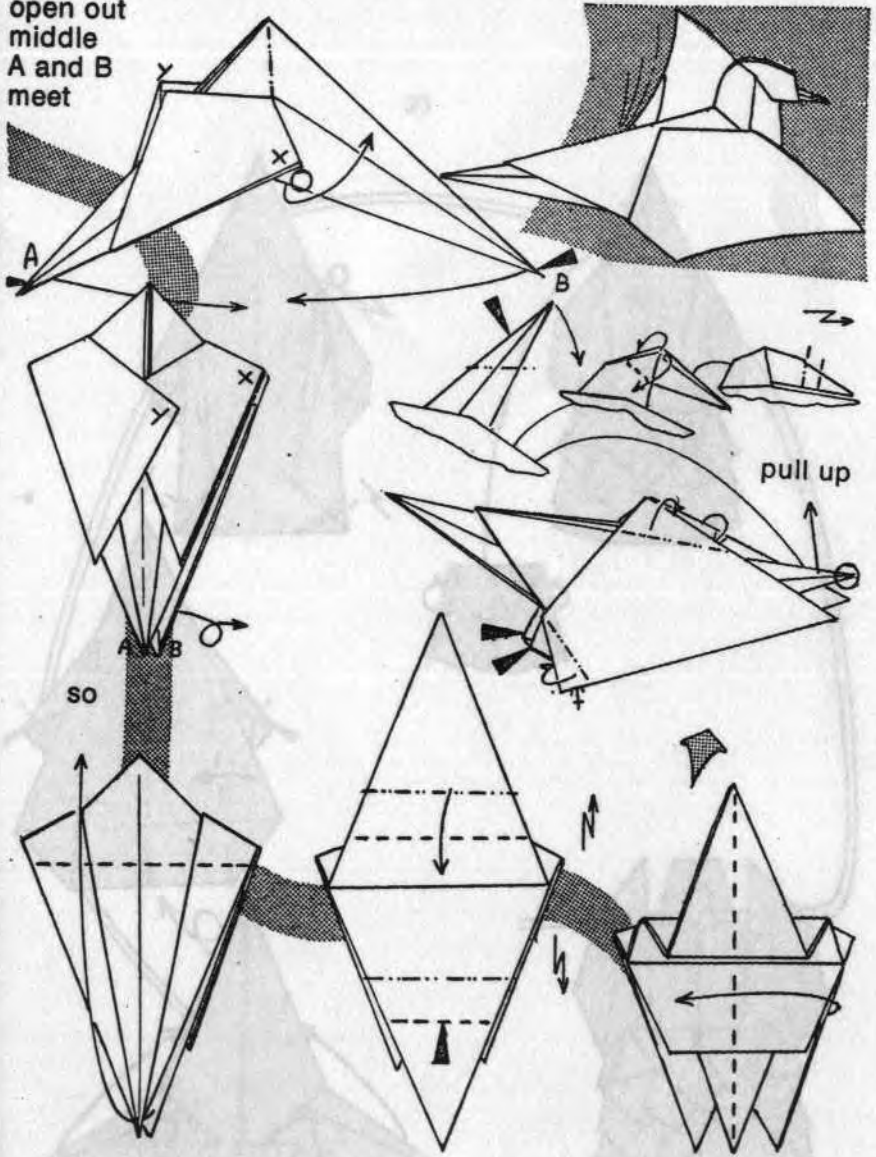

pull up

so

Loch Ness Monster Steve Manthorp Gt. Britain

squash folds
(page 11)

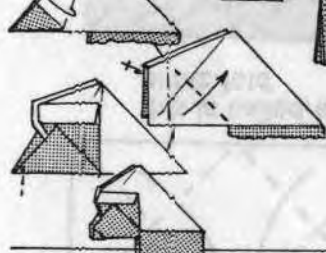
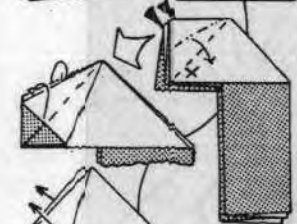
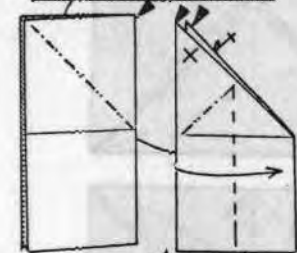
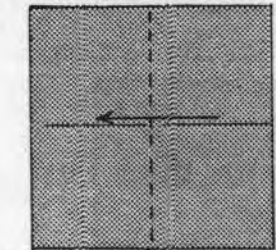

two of these

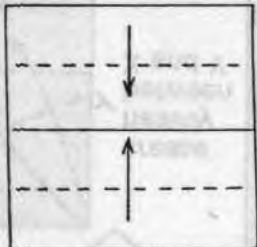

inside reverse folds

Gt. Britain

four squares the same size

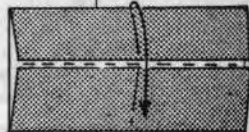
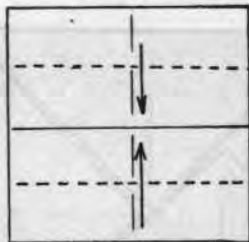

outside reverse fold
(page 13)

Christmas Ornament Toshie Takahama

use metallic foil squares

Japan

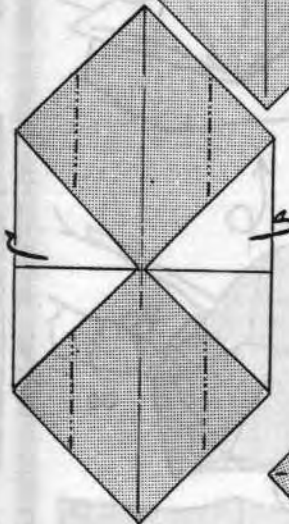
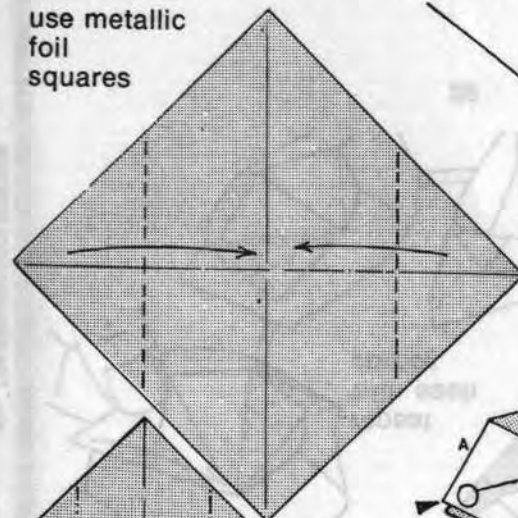

make one of
A colour
side up and B
white side up

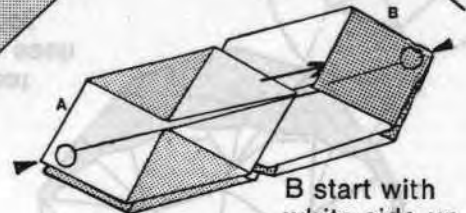
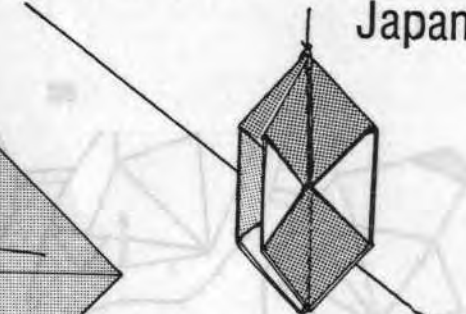

B start with
white side up

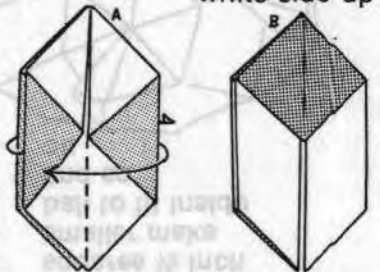

sink
corners

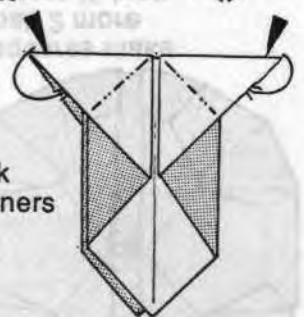

Ball in a Ball Iris Walker

Gt. Britain

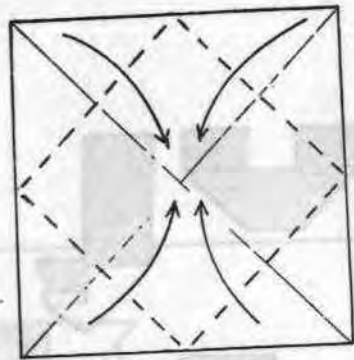

we now enlarge this corner next page

this is called a blintz fold

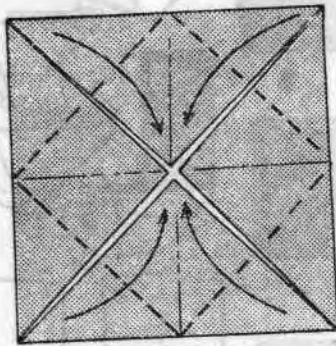

open out

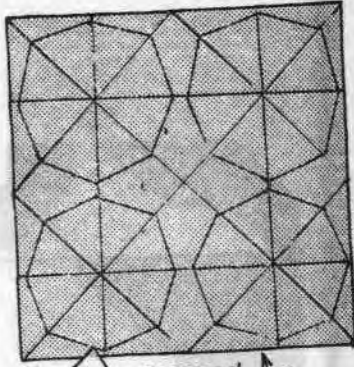

creased

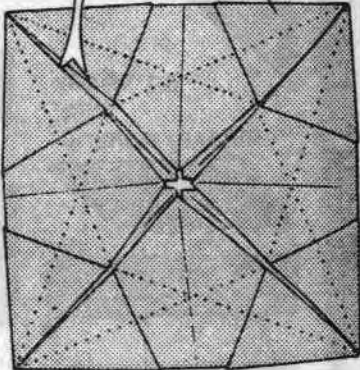

do this 8 times

crease heavily between X and Y

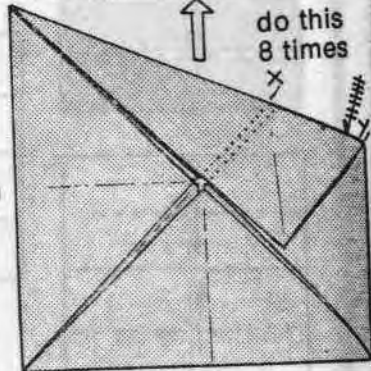
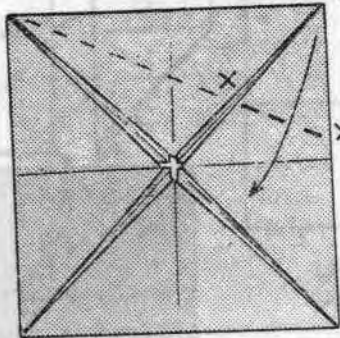

A Ball in a Ball concluded

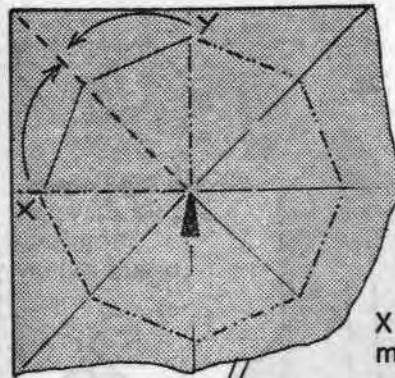

X and Y meet

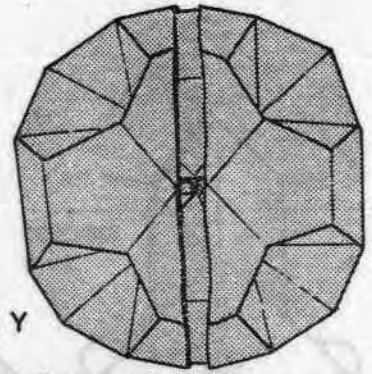

2 squares make a ball 2 more squares 1/2 inch smaller make ball to fit inside and so on

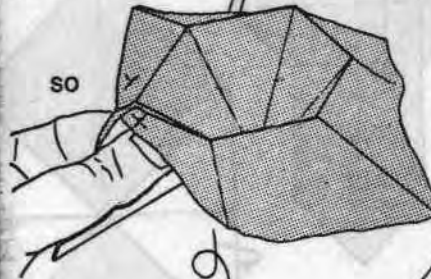

so

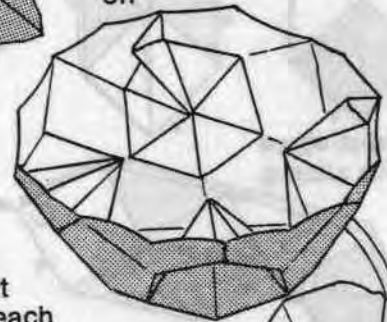

repeat with each corner



King of Spades Martin Lewis

U.S.A.

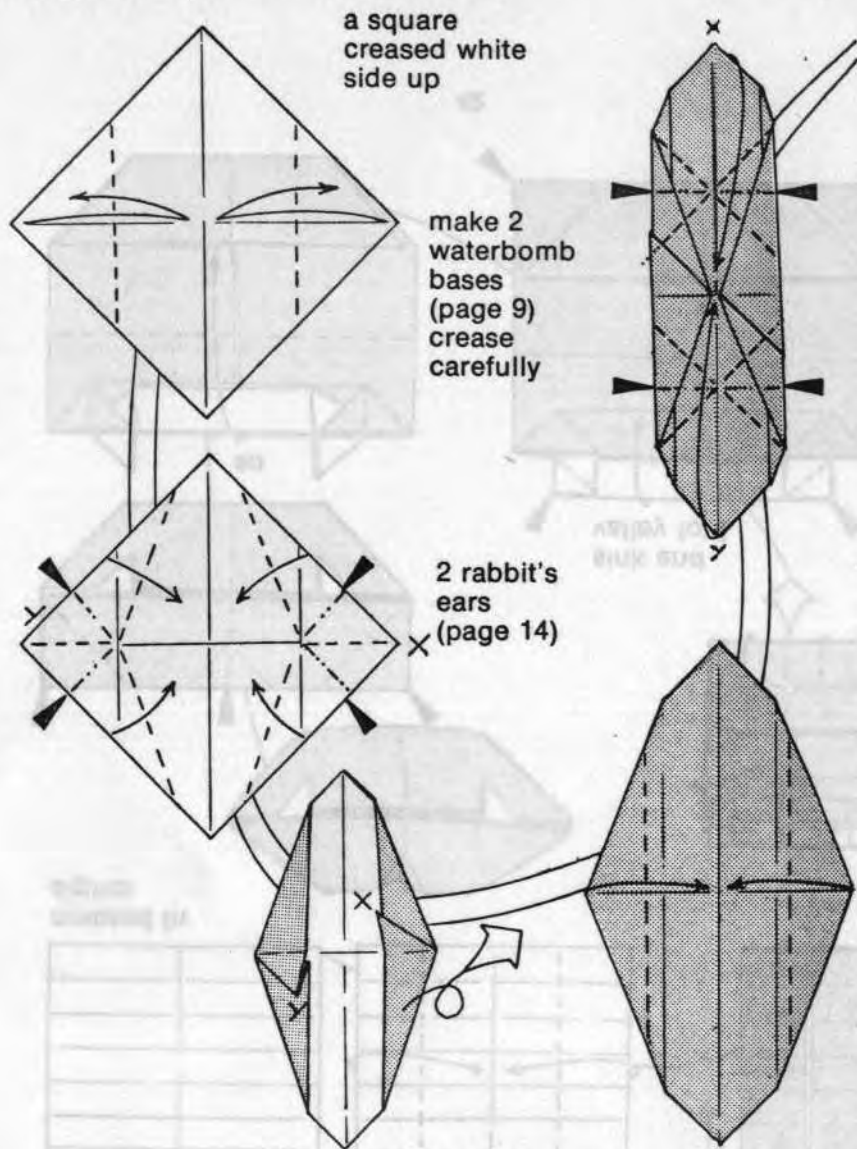

King of Spades concluded

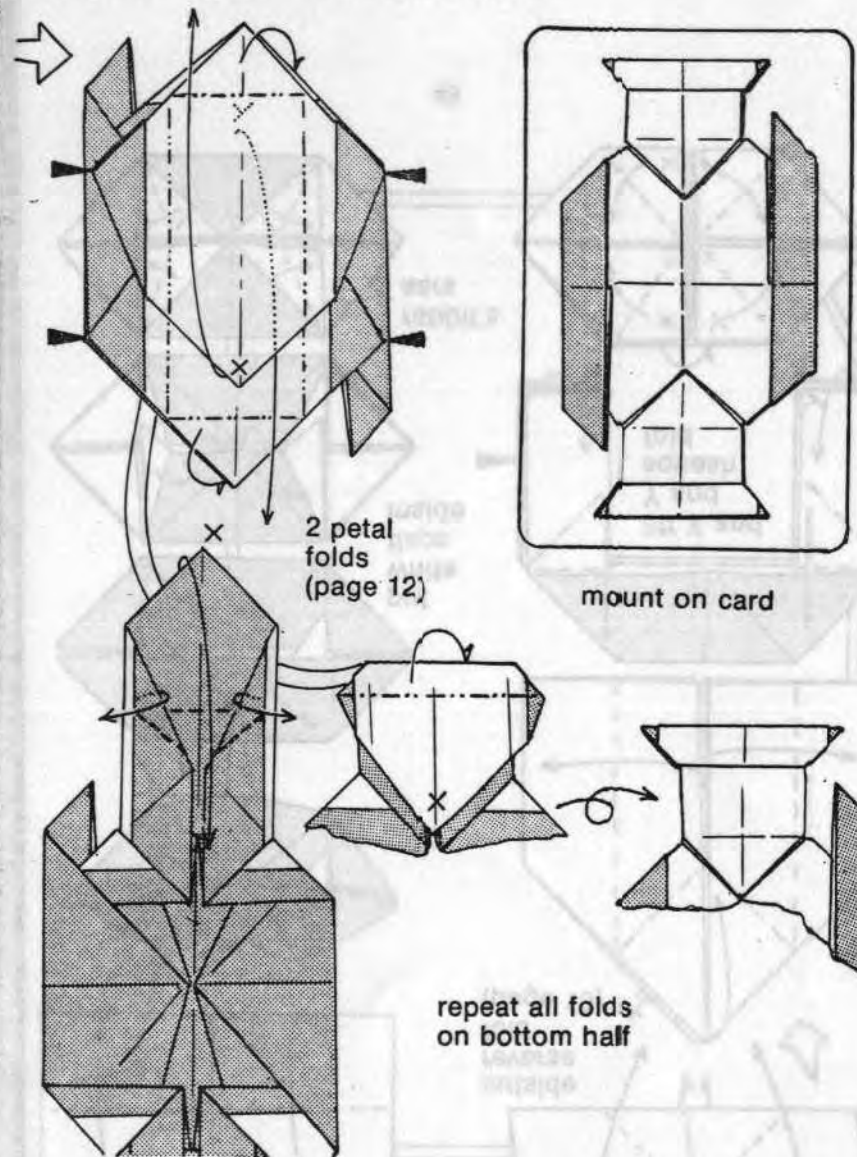

Dracula (3) Steven Biddle

Gt. Britain

a square creased as shown

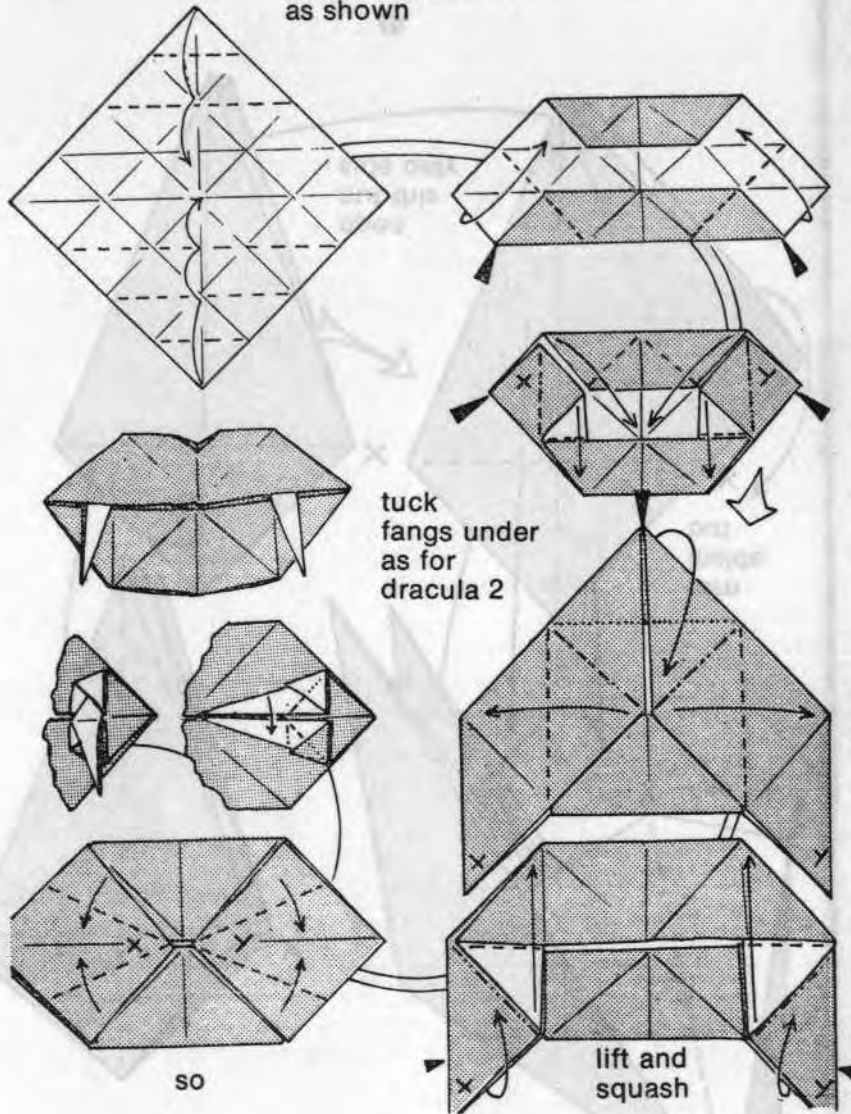

Dog Barking Clive Beeks

Gt. Britain

use a square brown one side

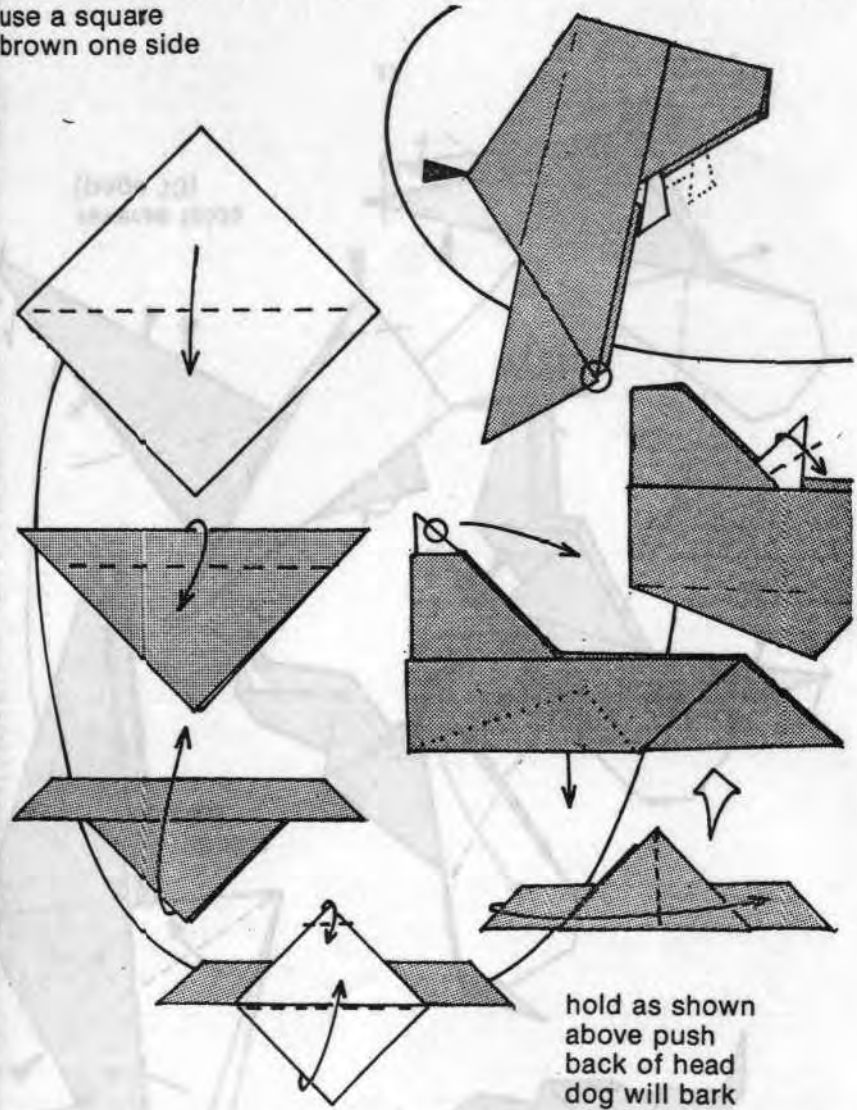

Swimmer Alice Blumberg

begin with a bird base
see pages 11 and 12

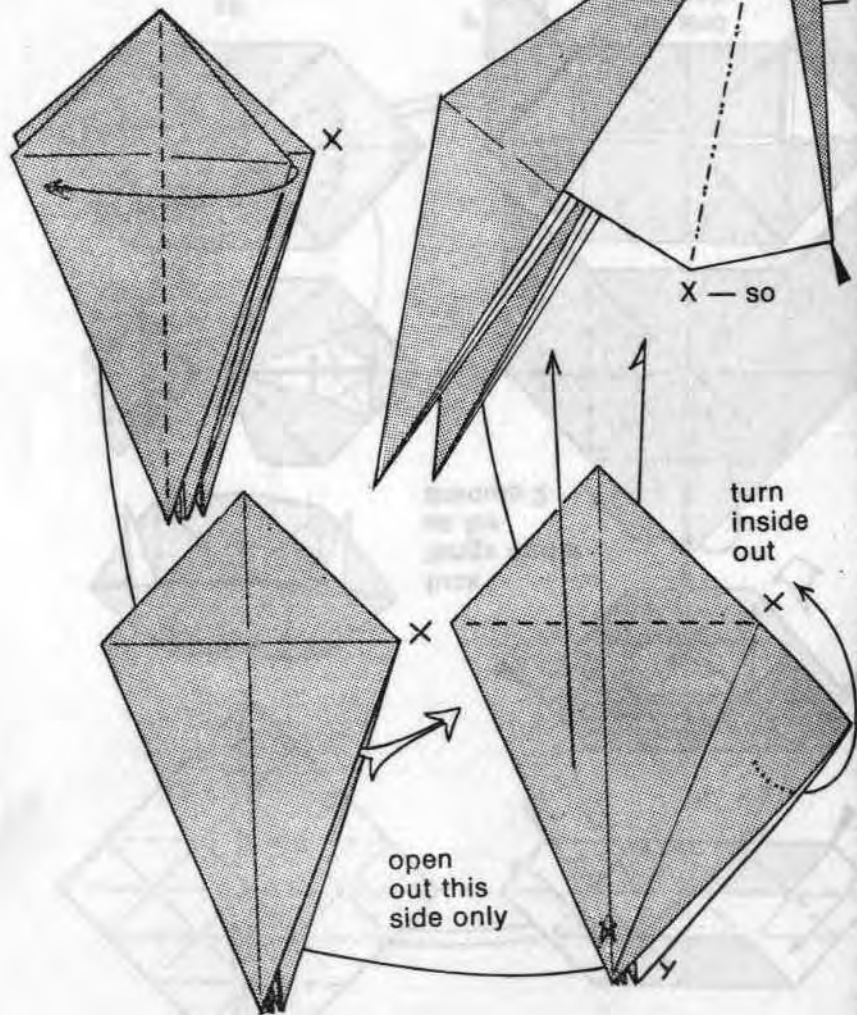

U.S.A.

Swimmer concluded Watch for reverse folds

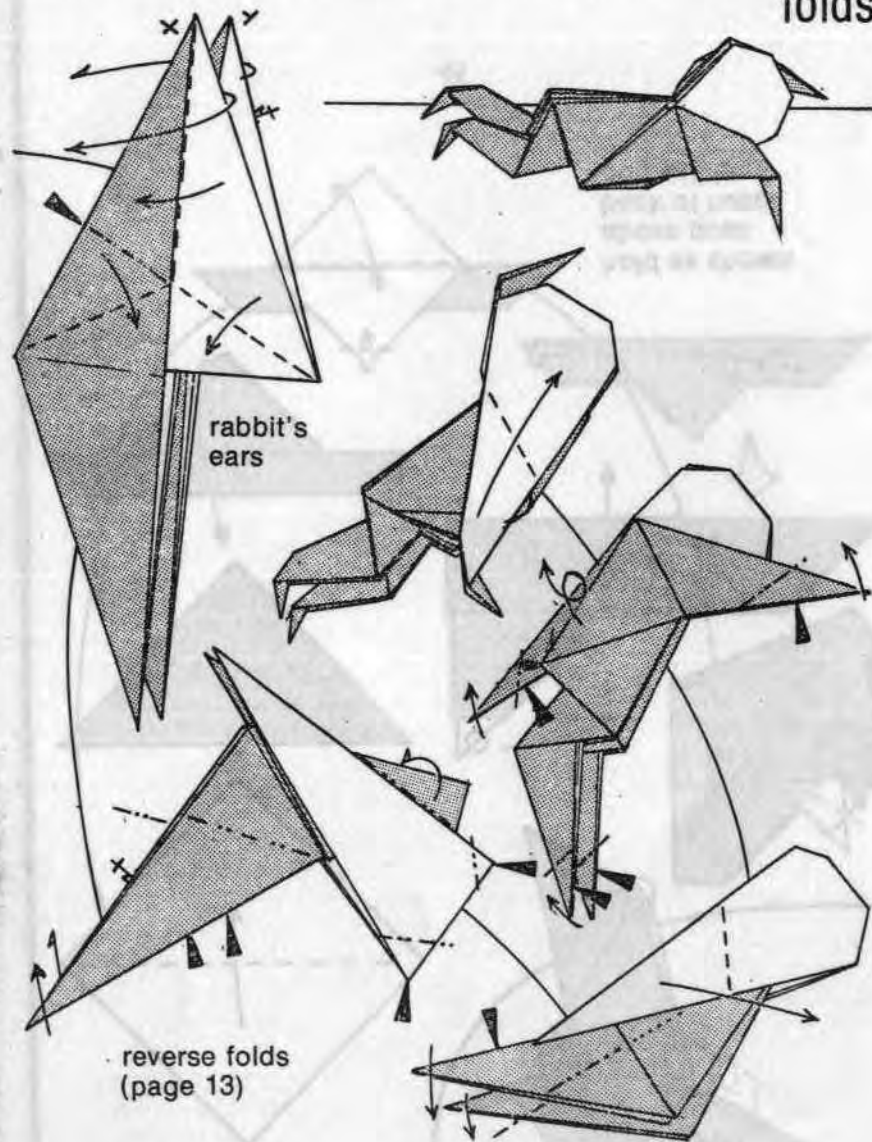

Rabbit Alice Gray

use half a square

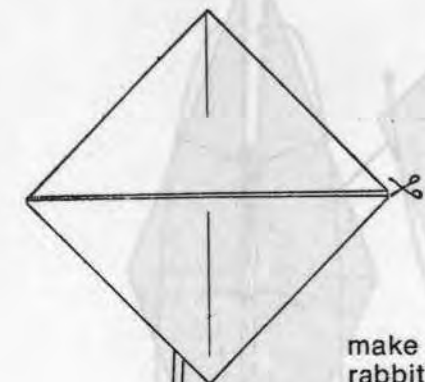

make two
rabbit's ears
(page 14)

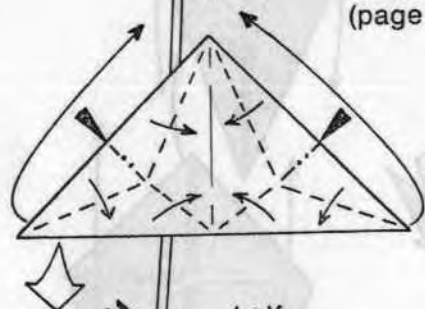

half
bird base

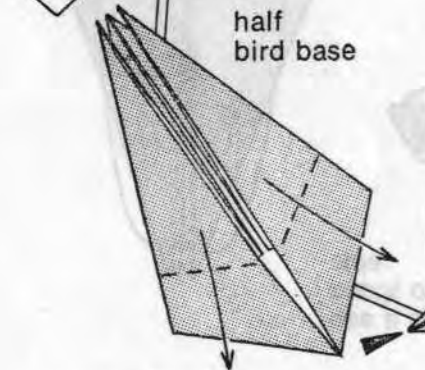

U.S.A.

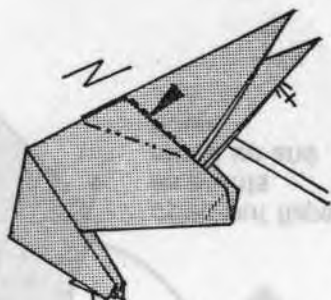

watch
this
double
fold

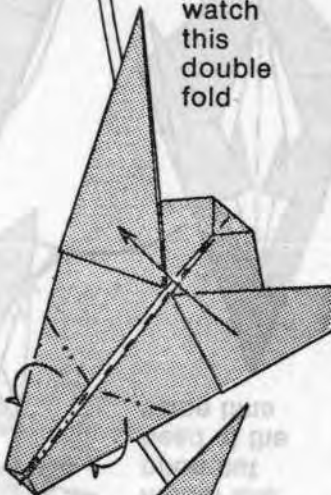

Rabbit concluded

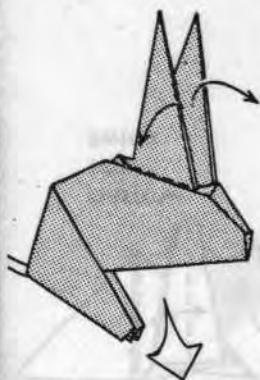

two squash
folds
(page 11)

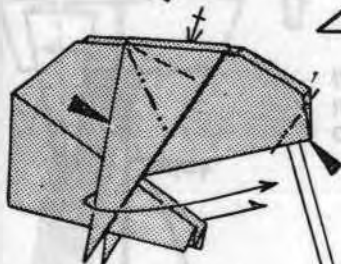

two petal
folds (page 12)

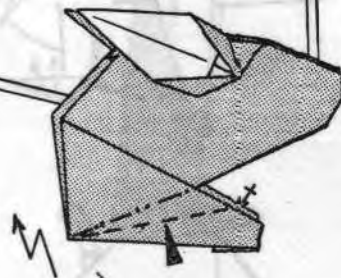
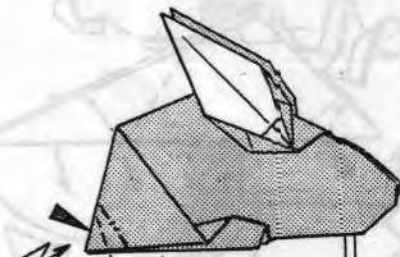
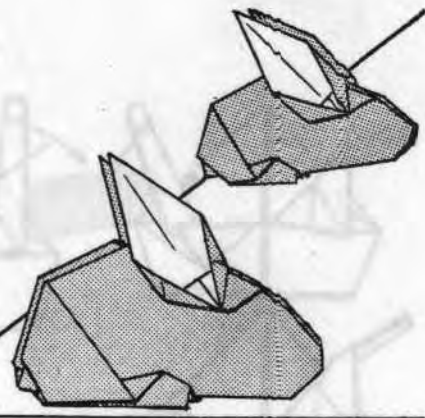
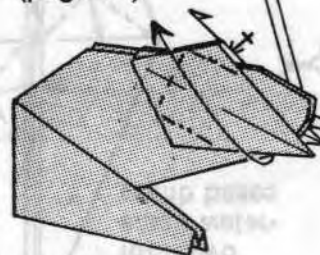

Penguin Alice Gray

begin with half
a bird base (page 12)

use a square
black one
side

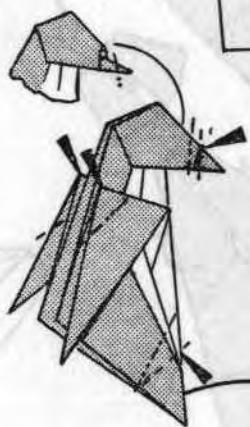
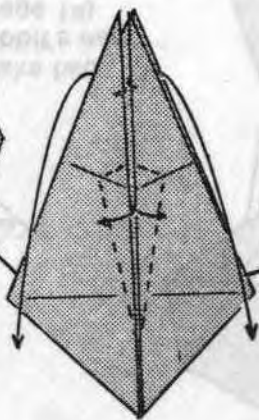
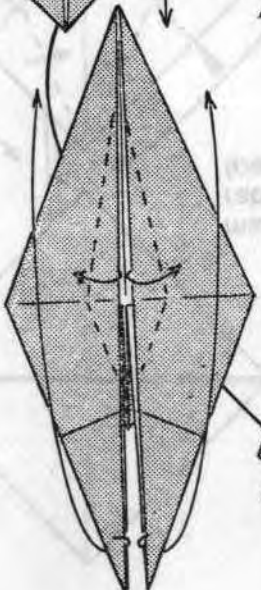
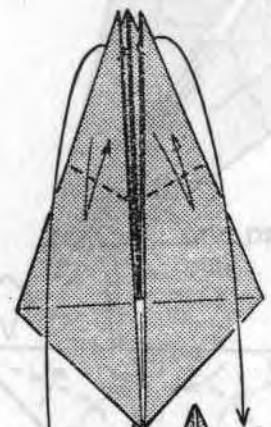

mountain fold
model and
open out
head at the
same time

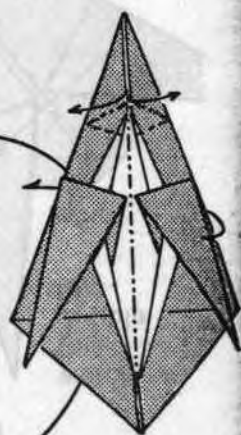

open out flaps
as points
move up and
down

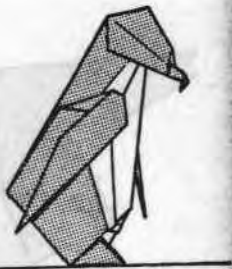

U.S.A. Goose Alice Gray

begin with half
a bird base (page 12)

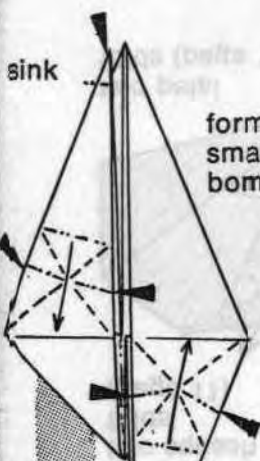

form two
small water-
bomb bases

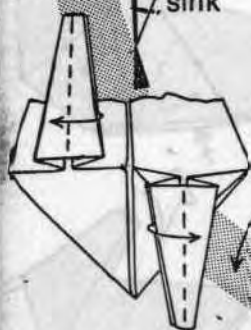

narrow
legs
twice

open
leg ends
form webs

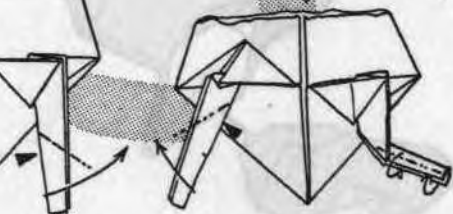
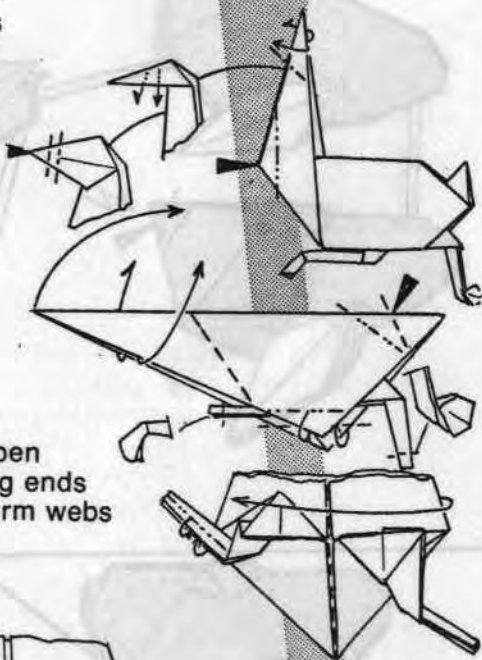
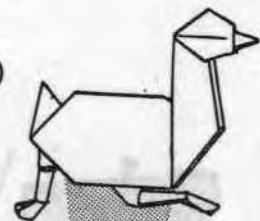
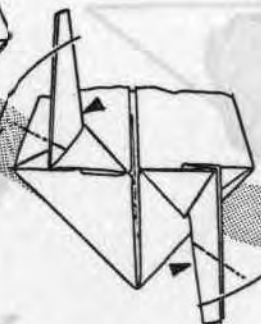

3 Piece Jumbo Alice Gray

U.S.A. 3 Piece Jumbo continued

begin with three half
a bird bases (page 12)

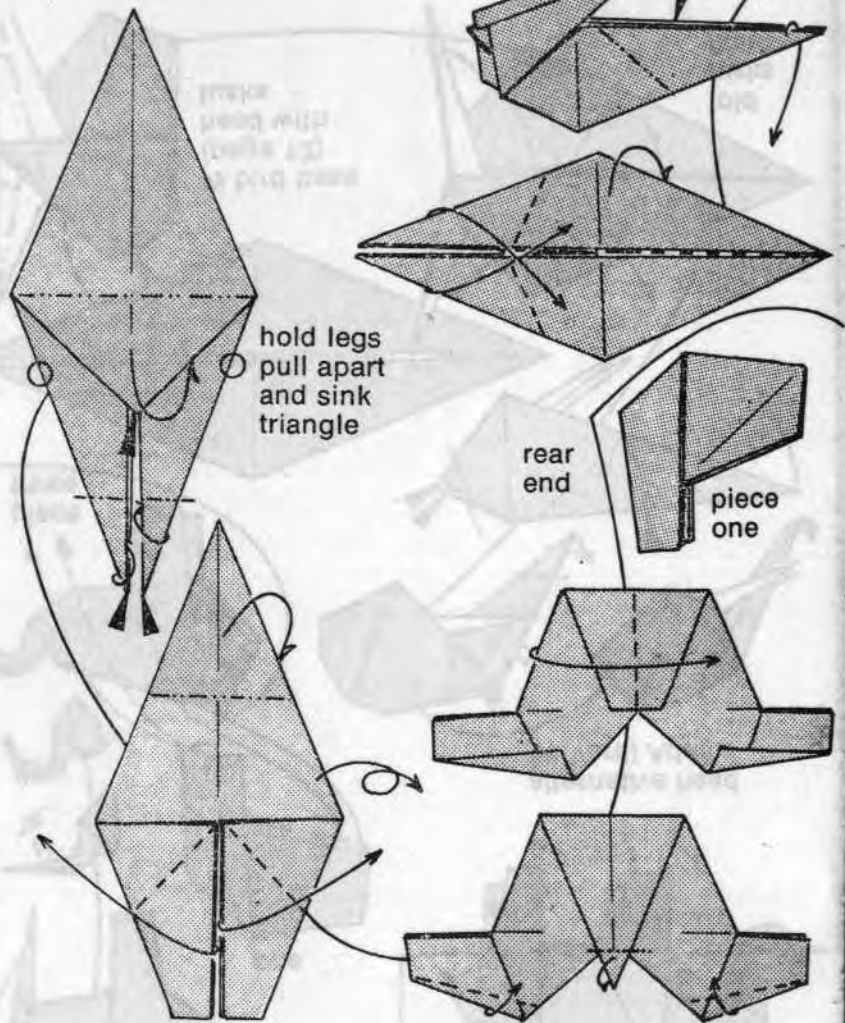

hold legs
pull apart
and sink
triangle

rear
end

piece
one

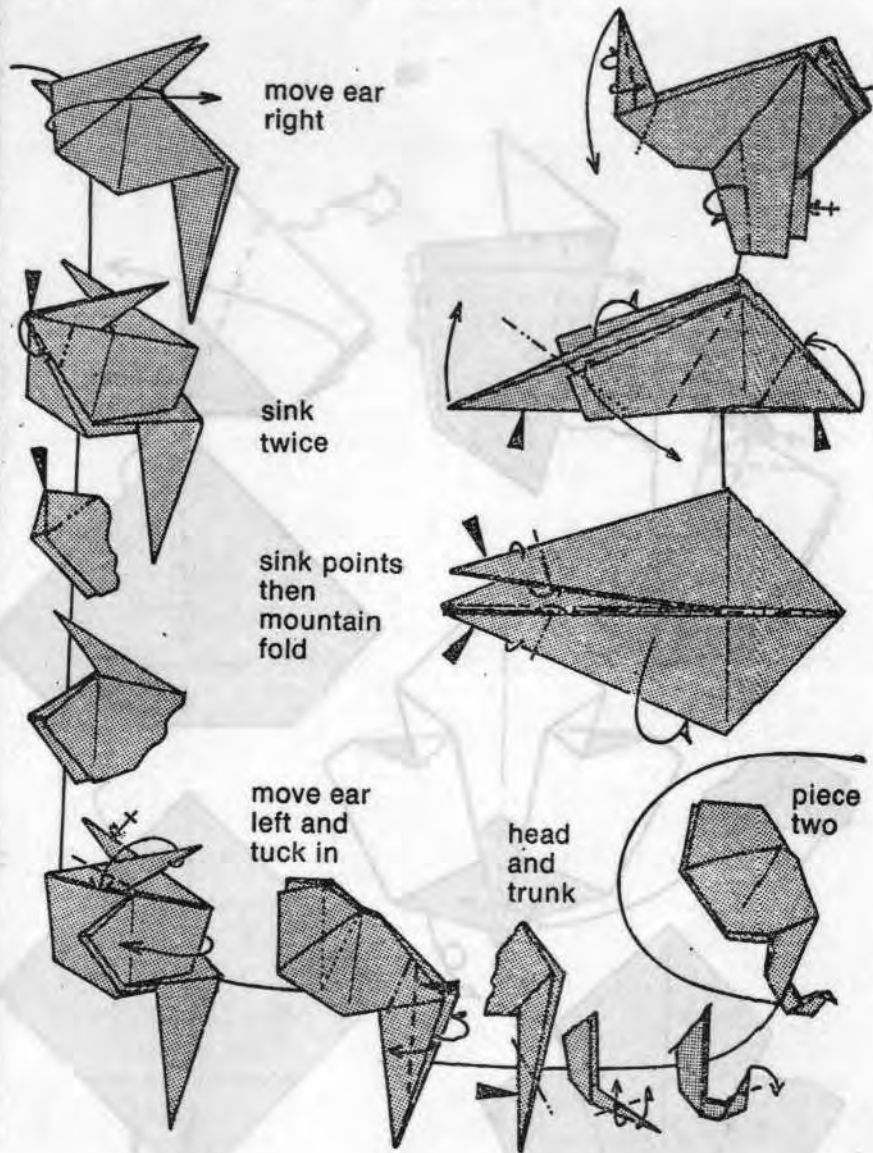

move ear
right

sink
twice

sink points
then
mountain
fold

move ear
left and
tuck in

head
and
trunk

piece
two

Jumbo Assemble pieces 1, 2, 3

Use a little glue

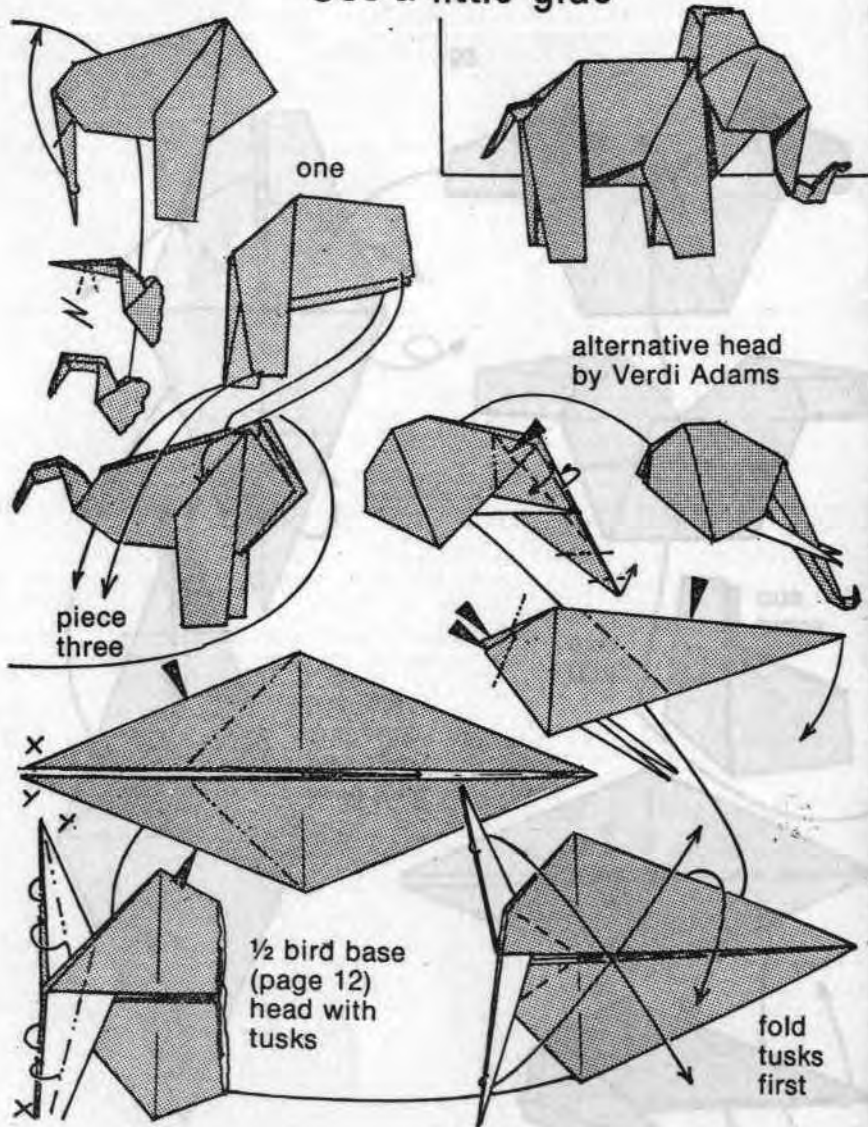

Maple-leaf Alice Gray

U.S.A.

use a square of foil

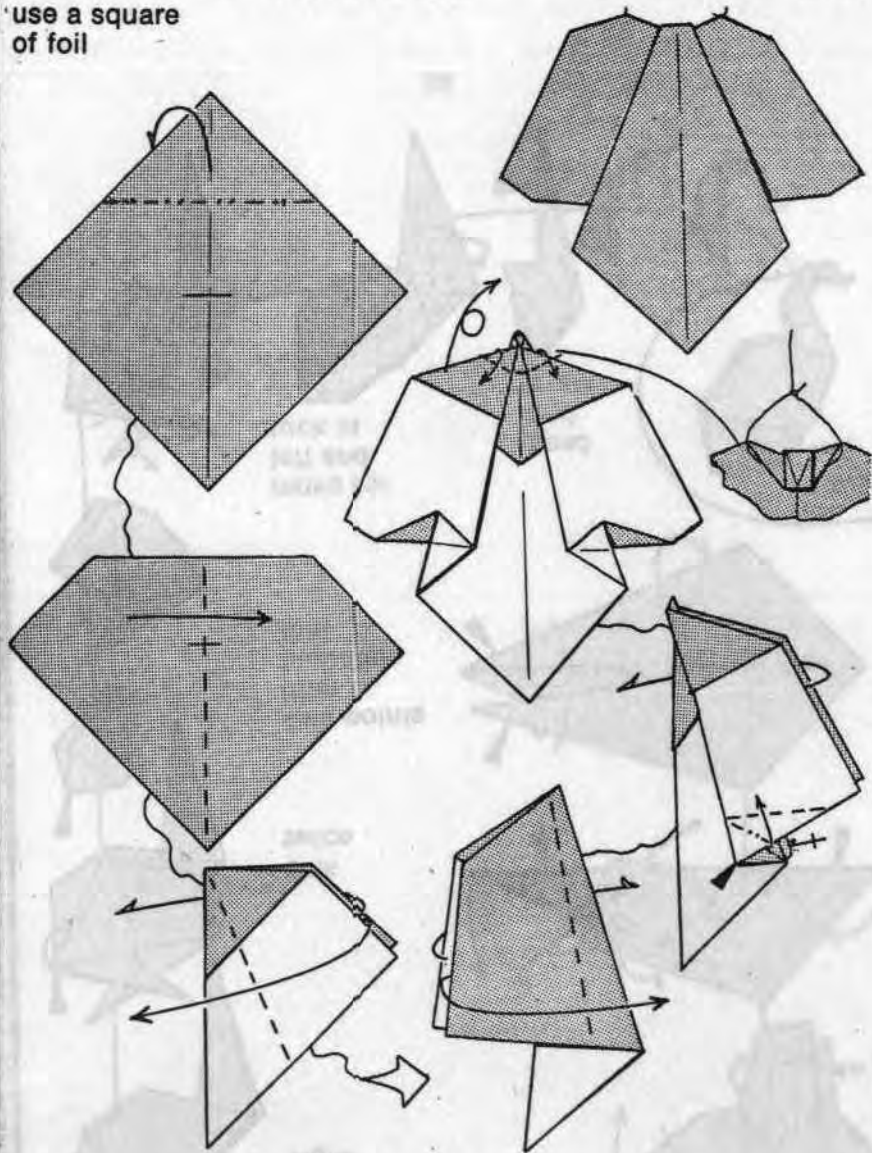

Baby Dragon Bill Warner

U.S.A.

use a square green one side. Fold corners to centre (blintz) make 4 rabbit's ears (page 14)

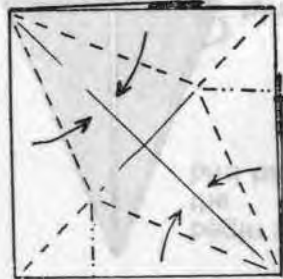
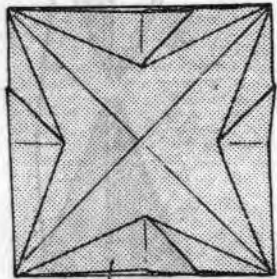
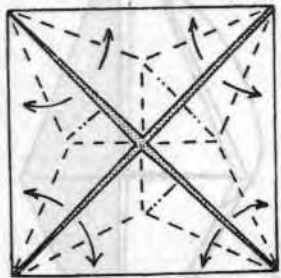

2 rabbit's ears

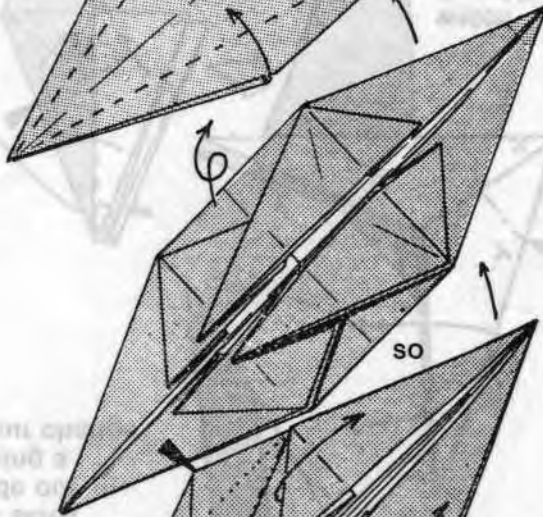
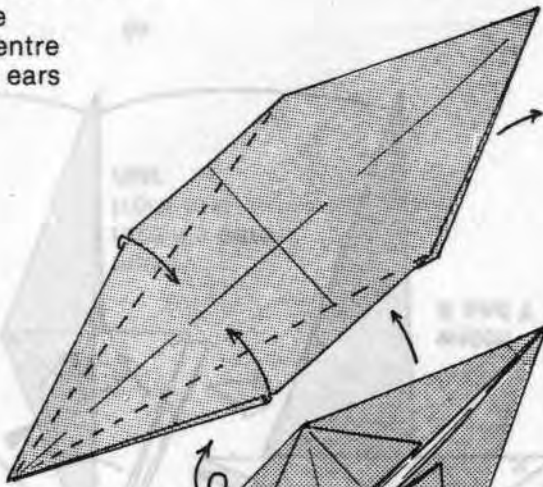

so

raise points to sink

sink 2 corners (see page 16)

Baby Dragon continued

This is an easy one

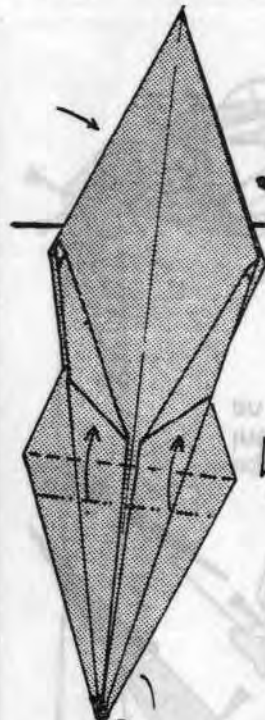

watch the 'crimps'

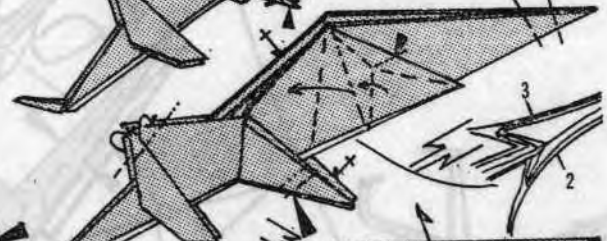
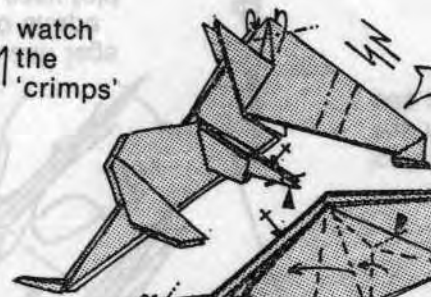
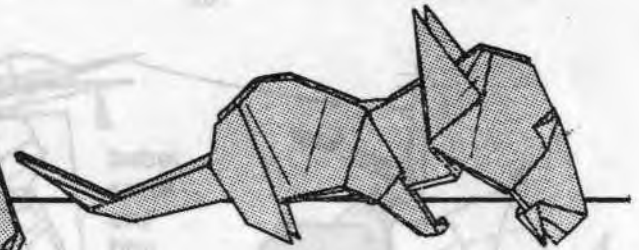

mountain fold in half

Ostrich David Pacheco

U.S.A.

use a square black one side

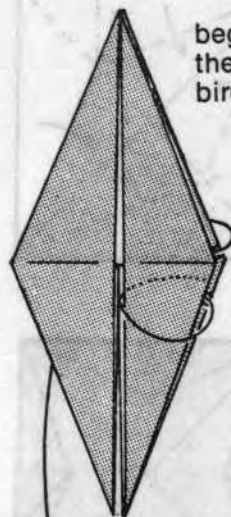

begin with the bird base

turn sides inside out making a colour change

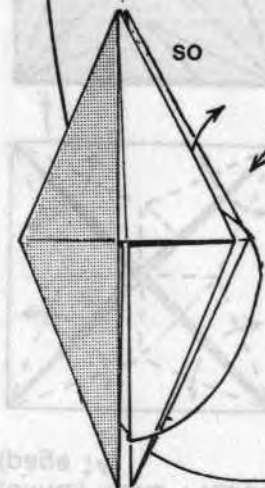

so

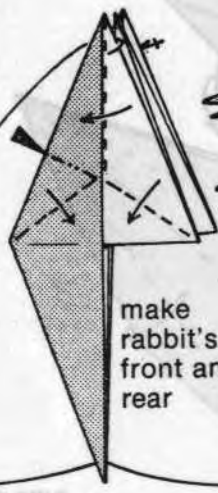

make rabbit's ears front and rear

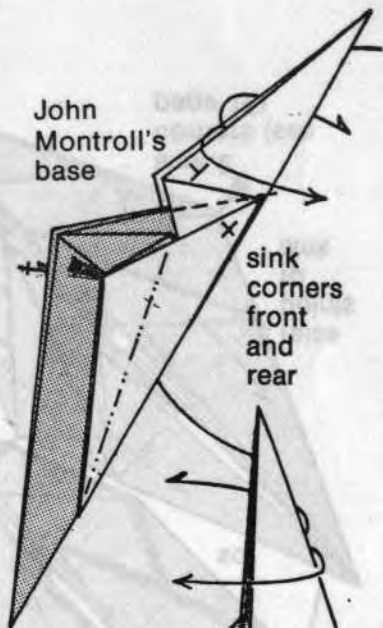

John Montroll's base

sink corners front and rear

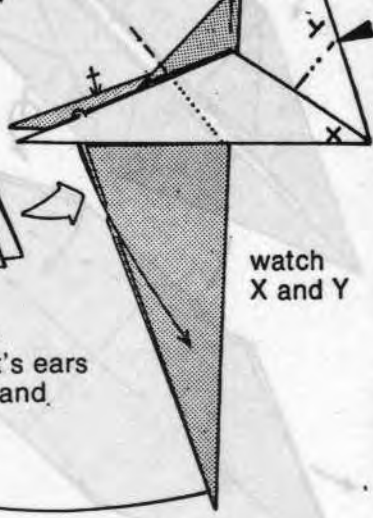

watch X and Y

Ostrich continued

I wish you luck here

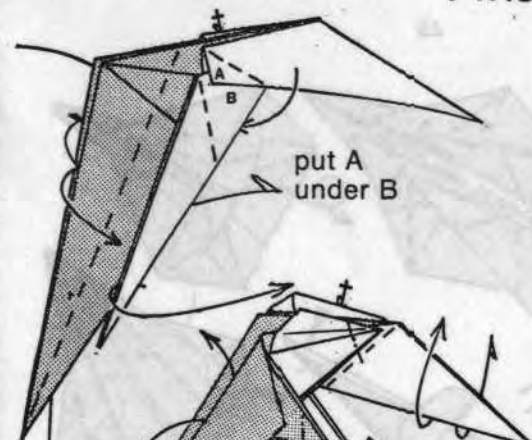

put A under B



squash legs into shape an easy fold

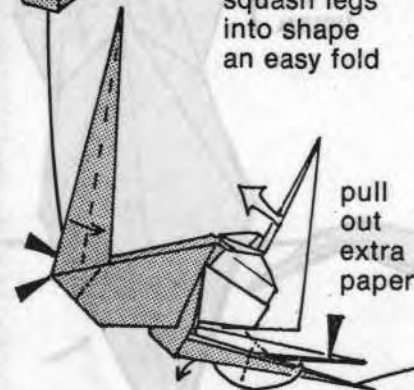

pull out extra paper

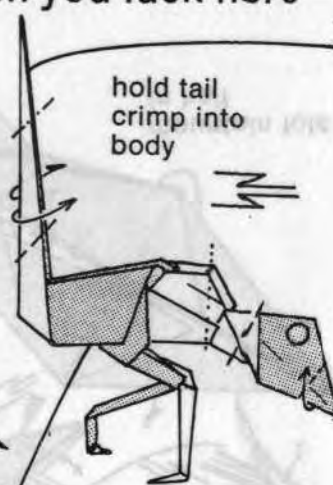

hold tail crimp into body

colour change the neck see page 58

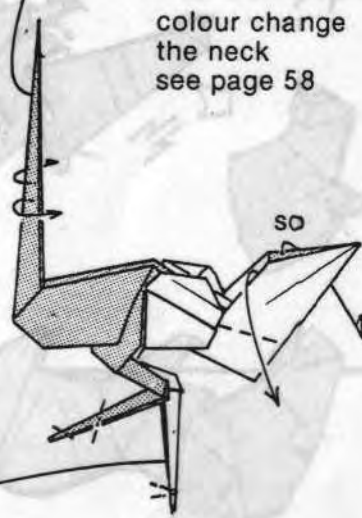

so

Ostrich continued

Fine model

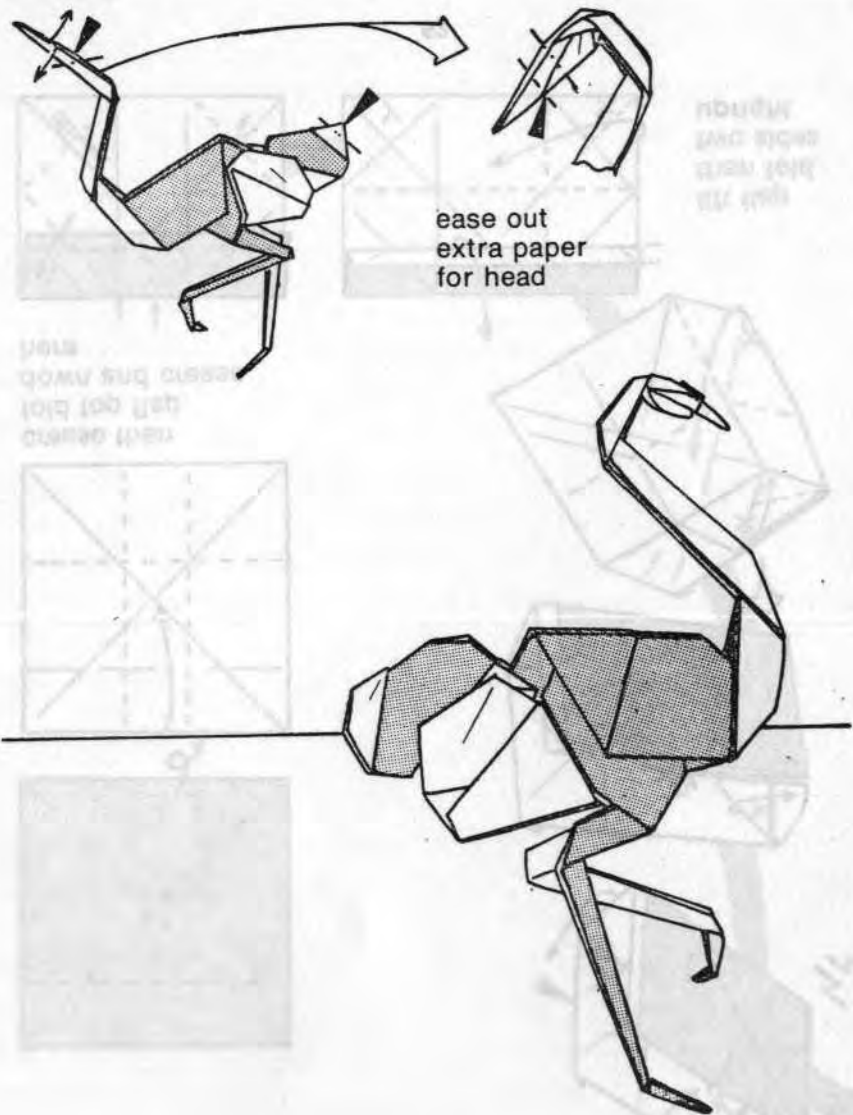

Mount Fuji Eric Kenneway

Gt. Britain

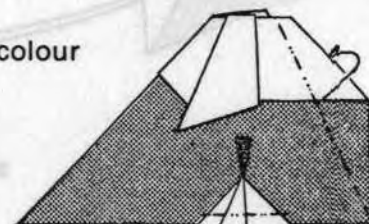
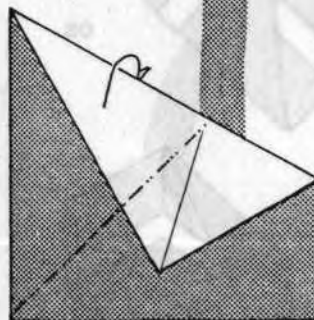
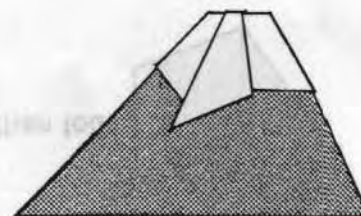
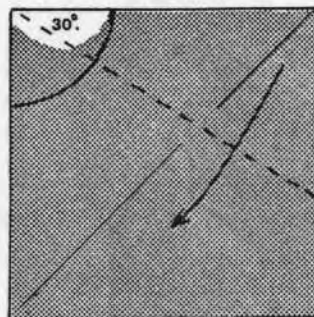

crimp left (page 15)

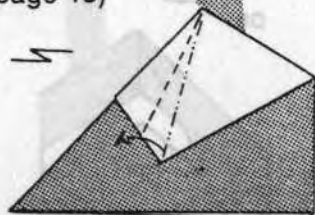
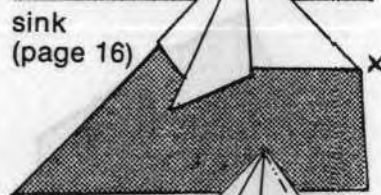

pull out flatten

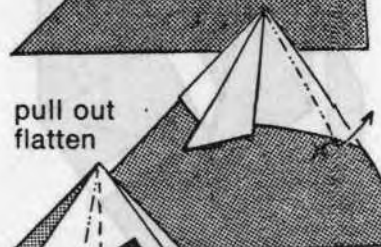

crimp again

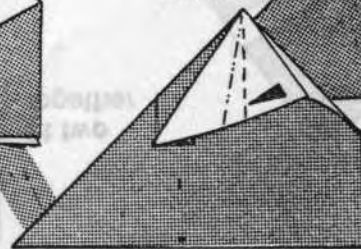

Super Box Lewis Simon

use 4 squares
coloured one side

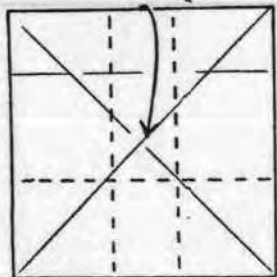
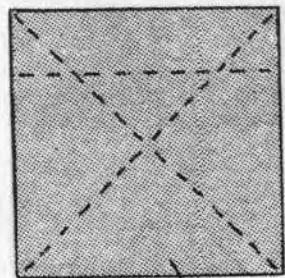

crease then
fold top flap
down and crease
here

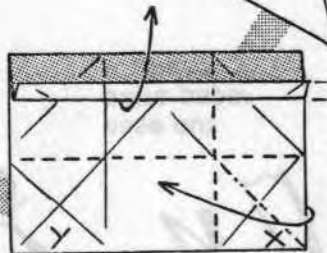
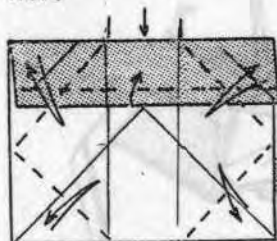

lift flap
then fold
two sides
upright

U.S.A.

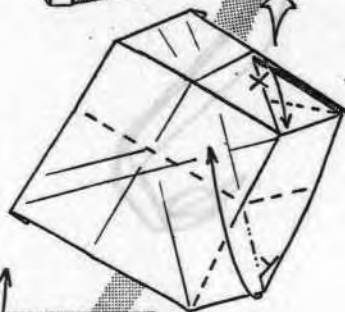
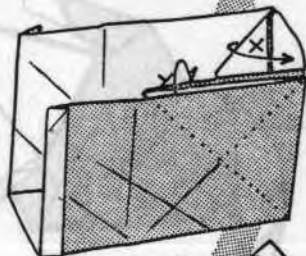
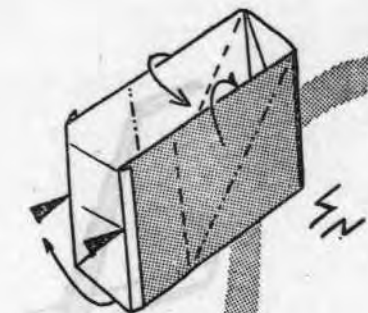

Super Box concluded

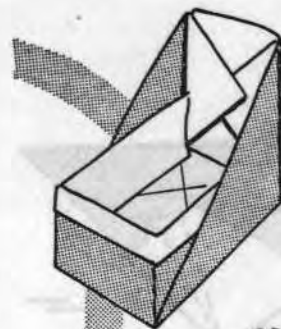

fit two
together

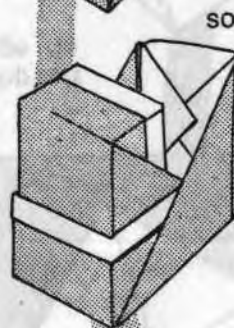

so

then three

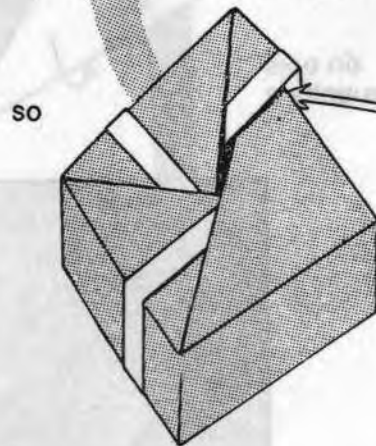

so

then four

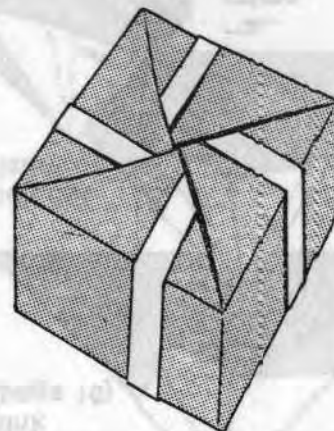

Gliding Toy (Anon) Simon Williams collection

square white
side up

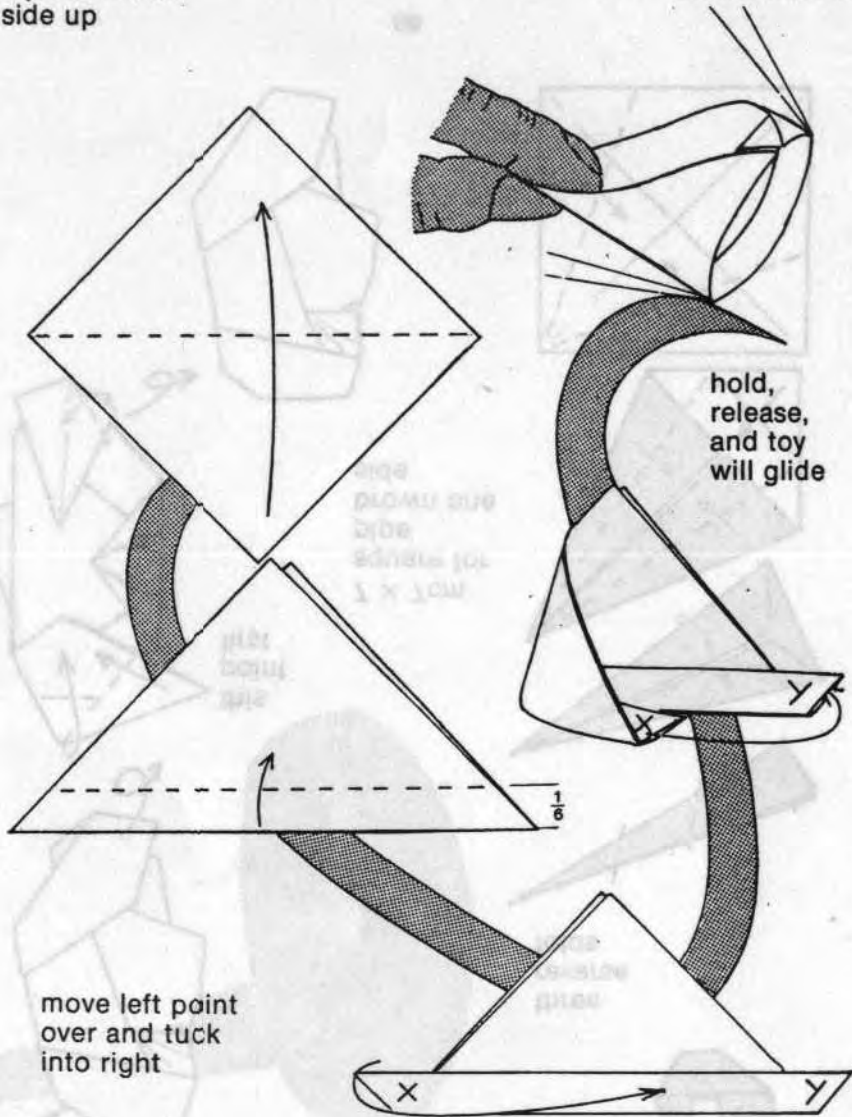

64

Sherlock Holmes Robert W. Allen U.S.A.

use a square black
one side 9 x 9cms

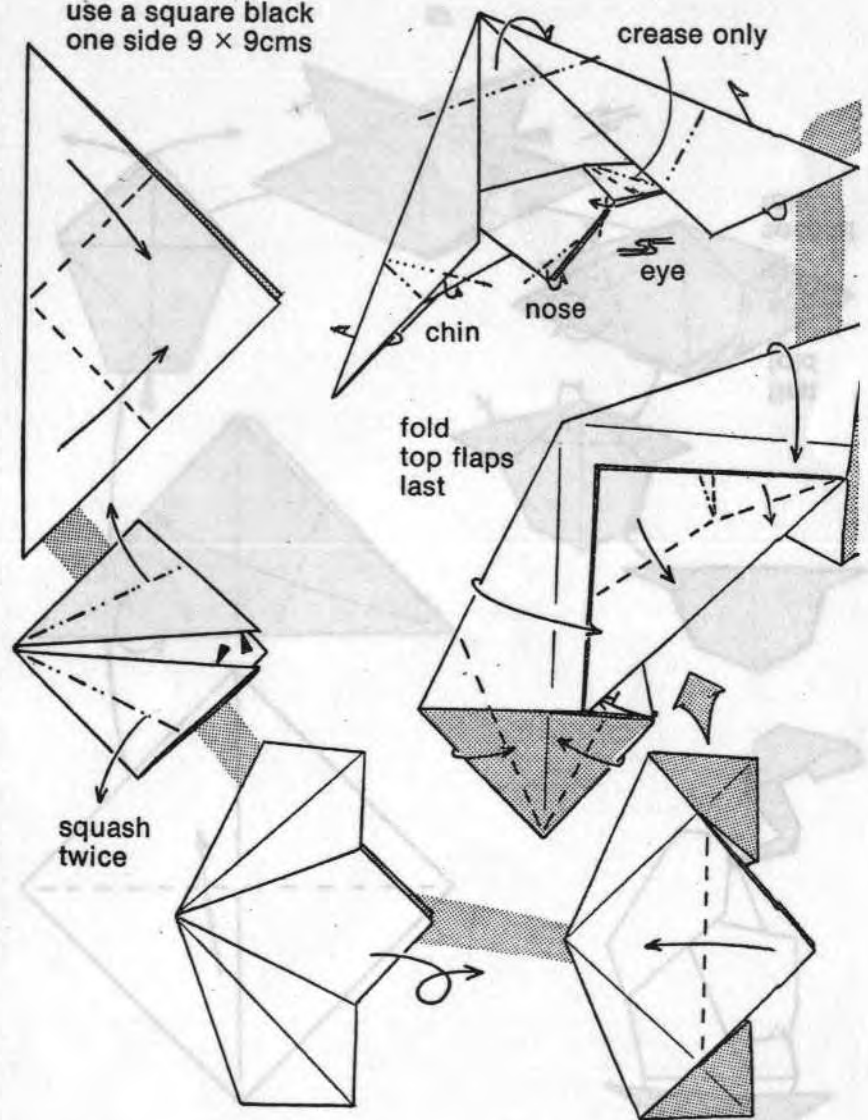

65

Sherlock Holmes continued

The Pipe

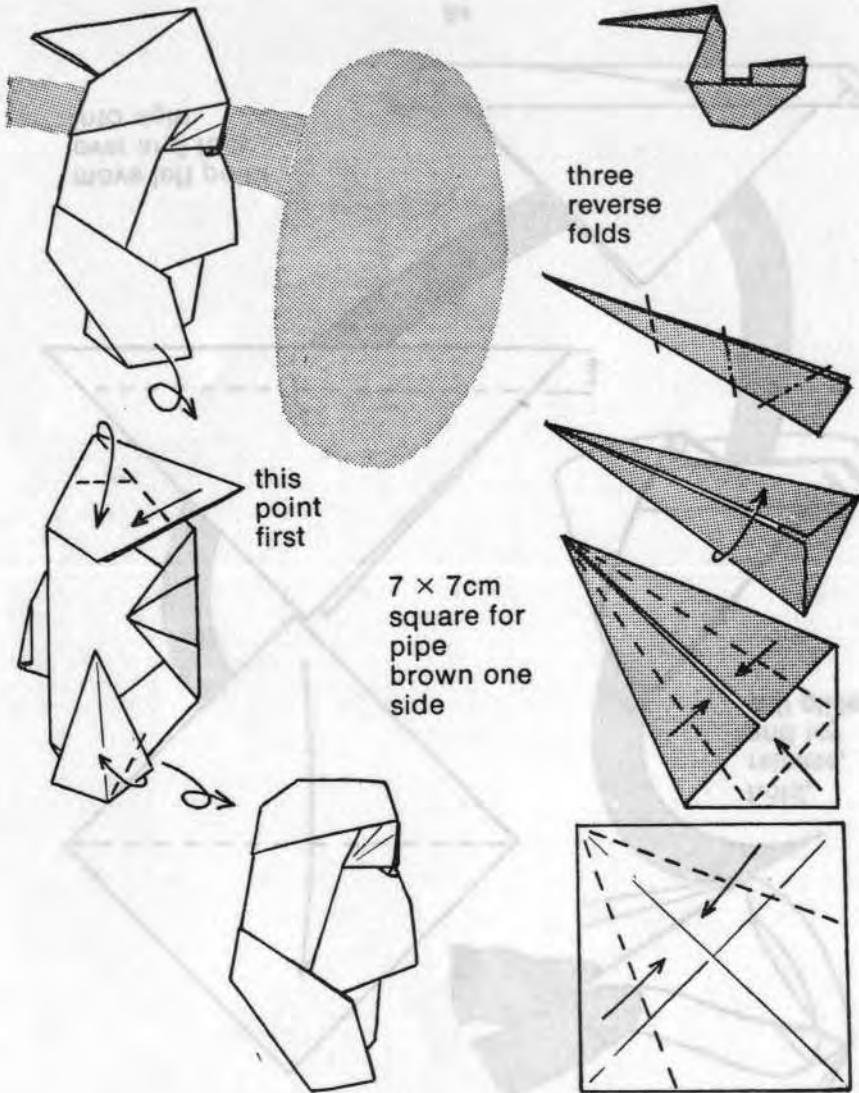

Sherlock Holmes with Hat and Pipe

8 × 8cm square
grey one side

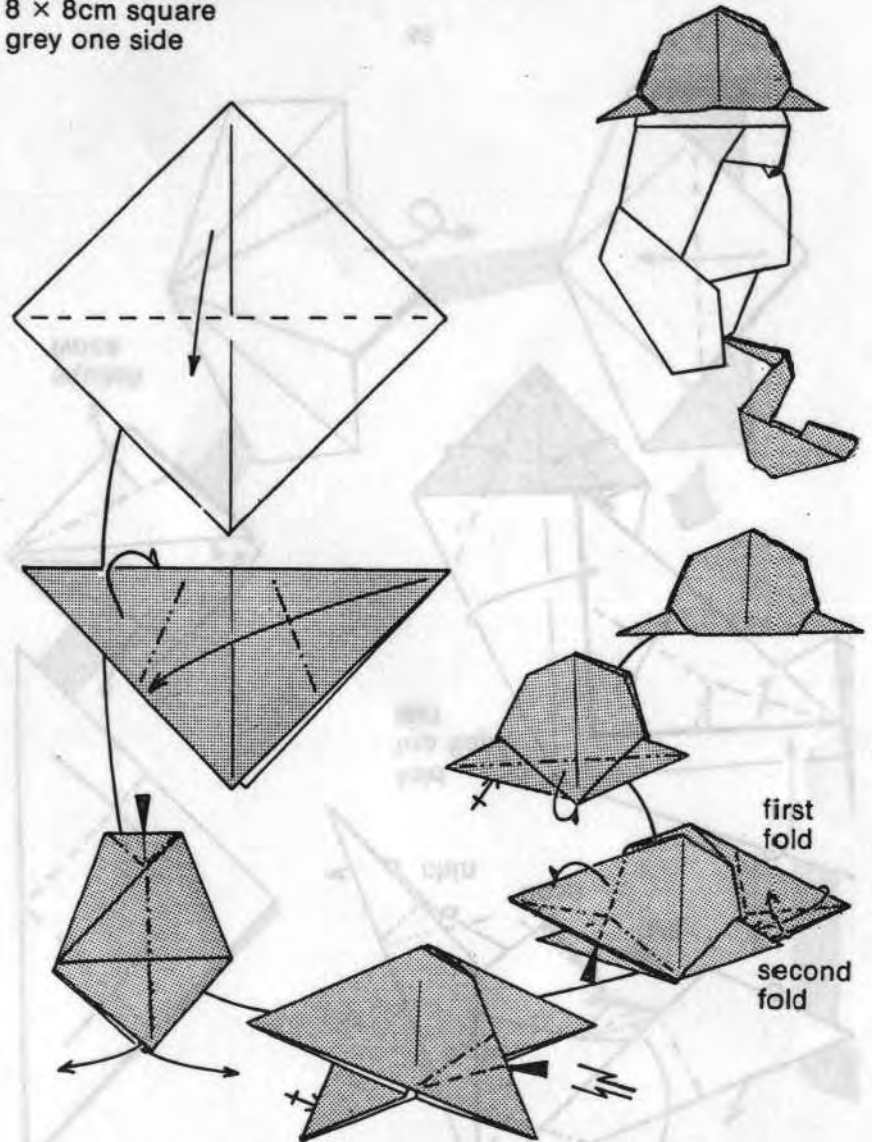

Smuggler's Wallet Vernon Holden Australia

use a large square
crease 8×8

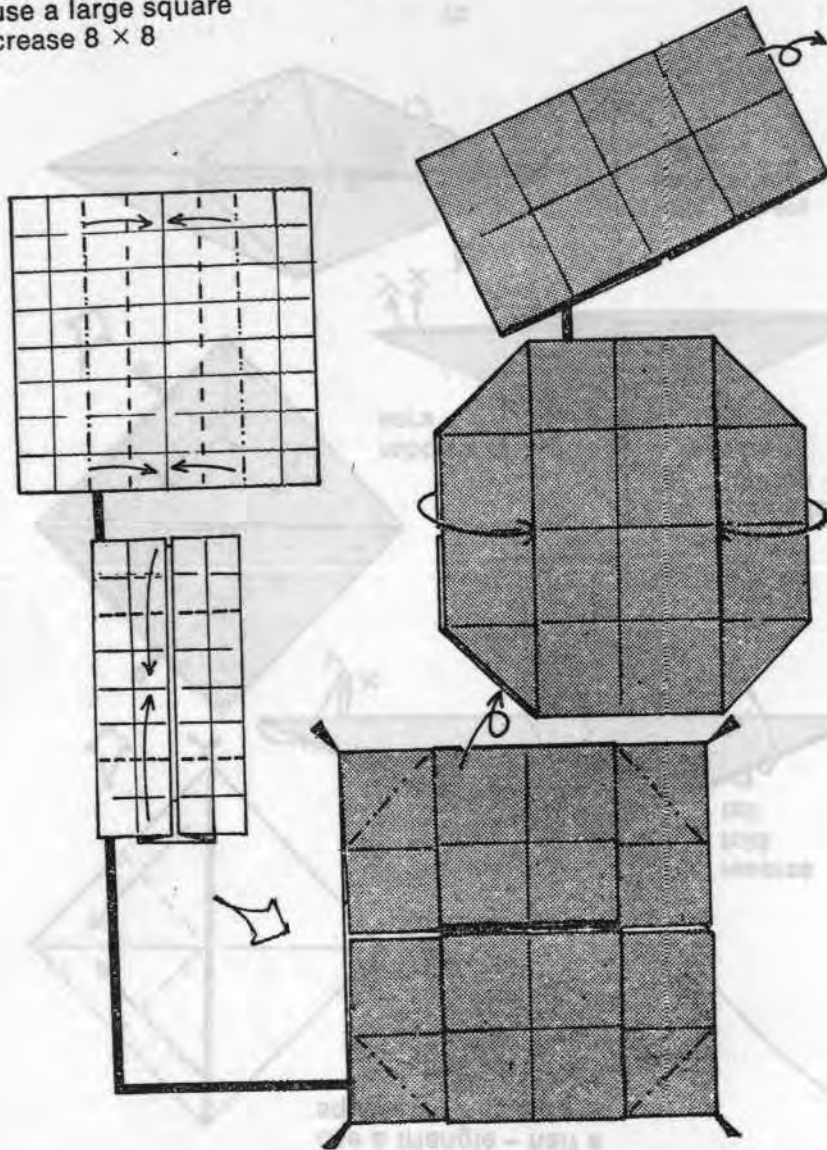

68

Smuggler's Wallet continued

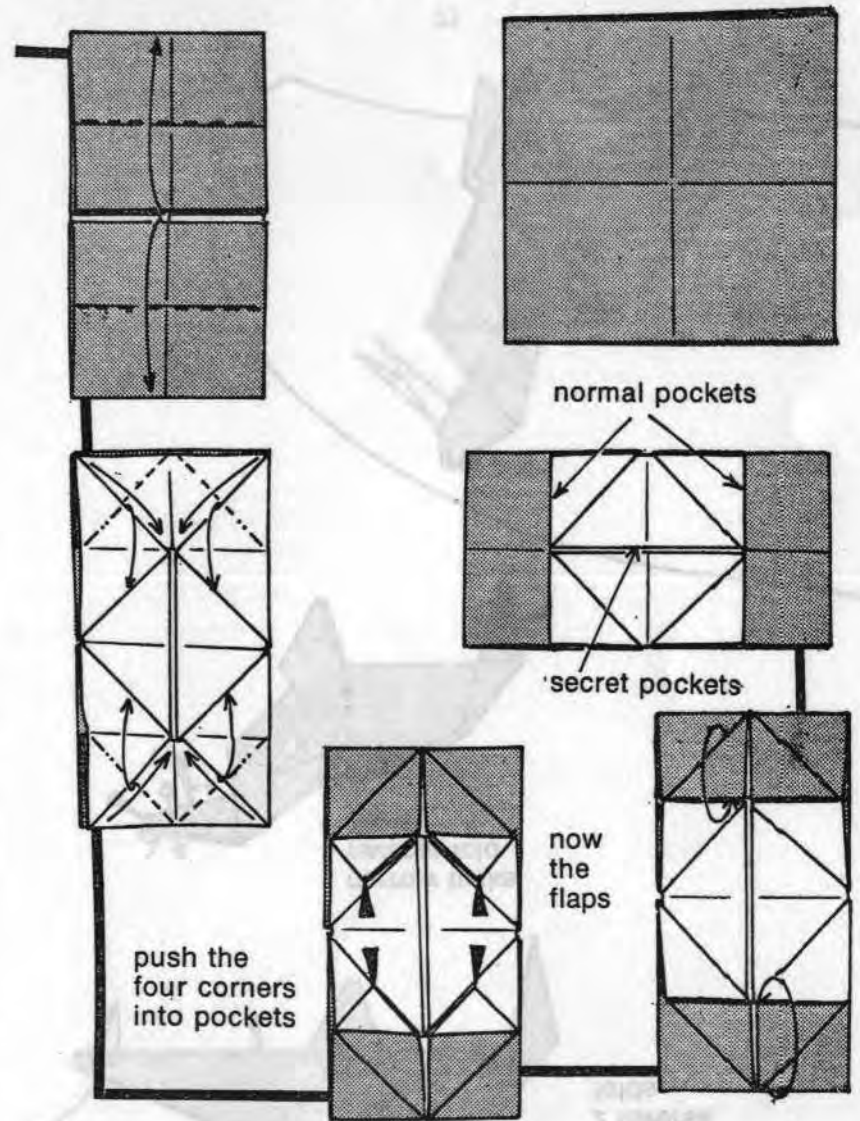

69

Walrus John French

Gt. Britain

Walrus concluded

use a triangle - half a square - white side up

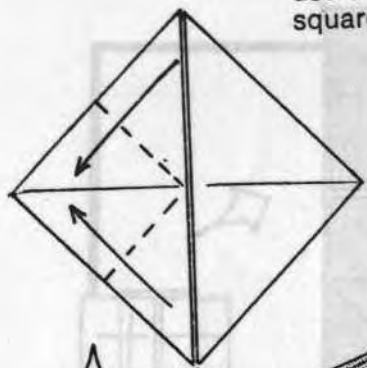

reverse fold tail

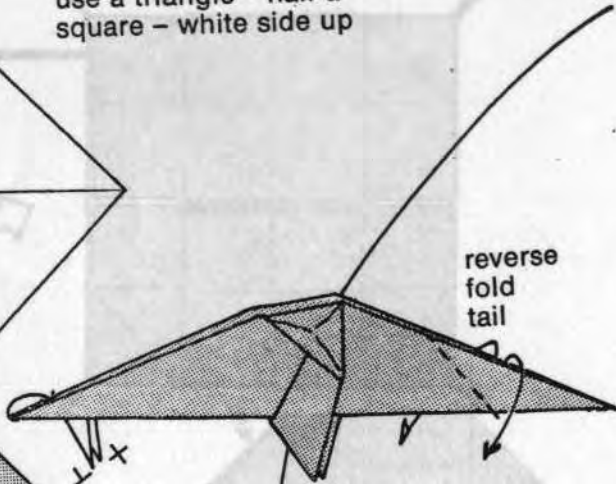

valley fold hidden tusks X Y

rabbit's ears

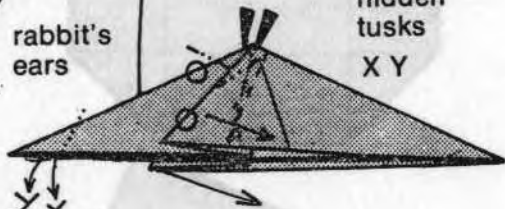

fold flippers and flatten corners

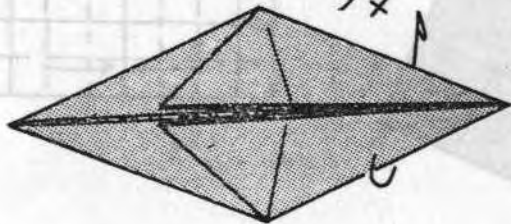

2 reverse folds

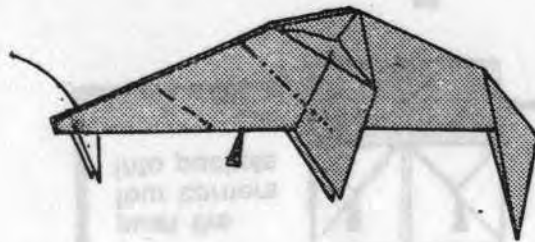

narrow tusks reverse fold head

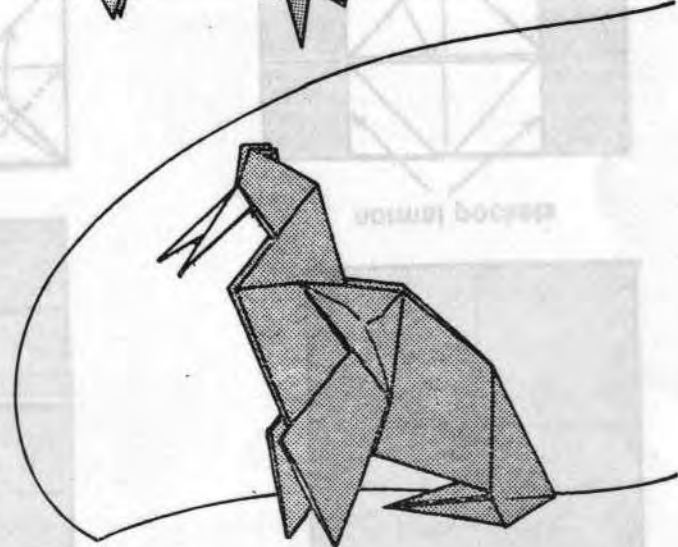
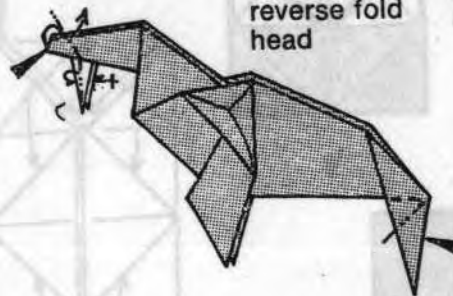

Humming Bird Gregory Knesner U.S.A.

begin with
a
bird base
(page 12)

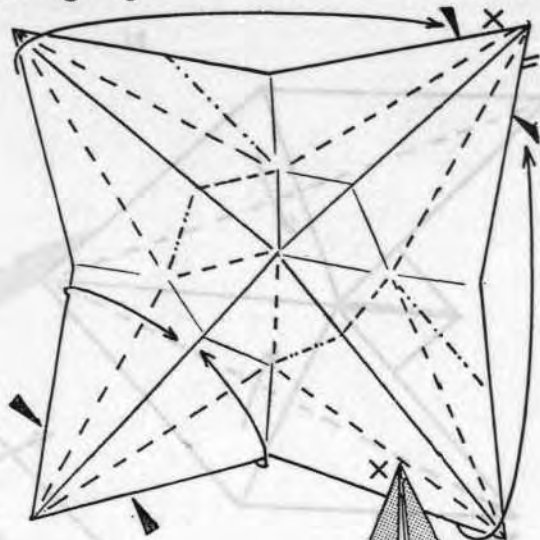
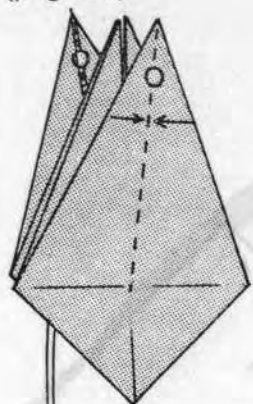

hold as indicated
and stretch

open out
push
middle
up

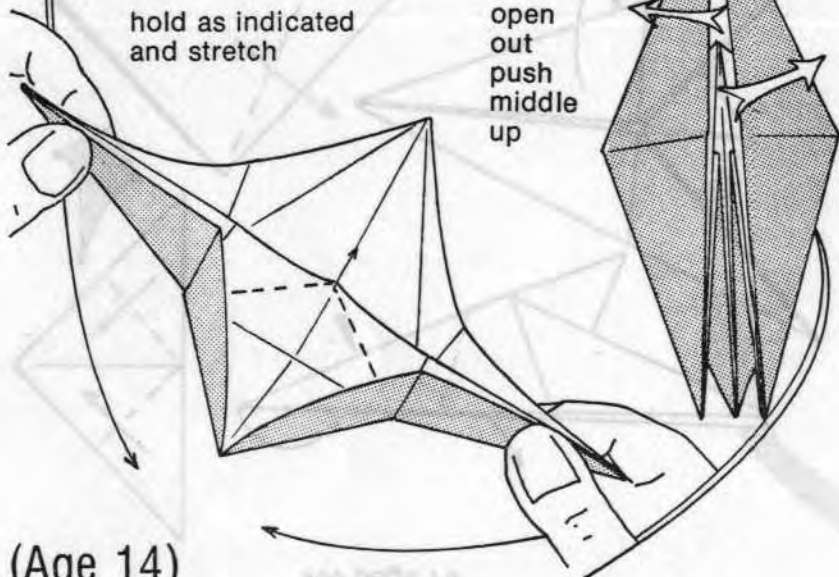

(Age 14)

Humming Bird concluded Excellent

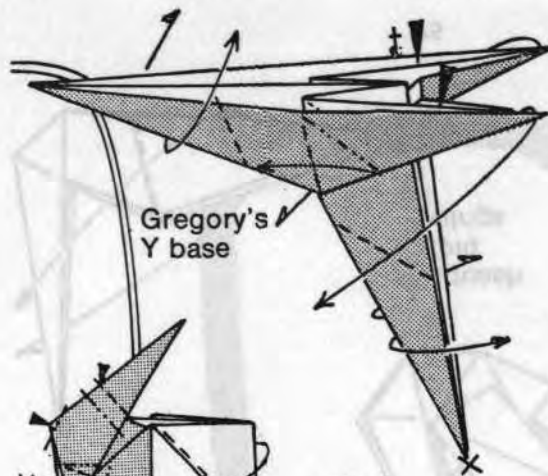

2 squash folds

2 outside
reverse
folds

Gregory's
Y base

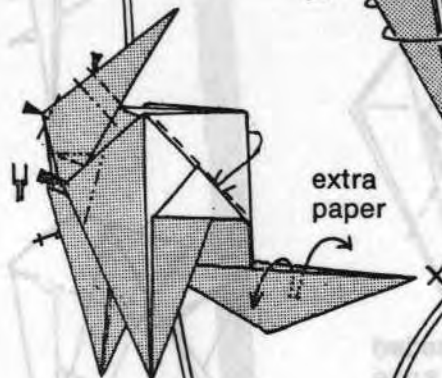

extra
paper

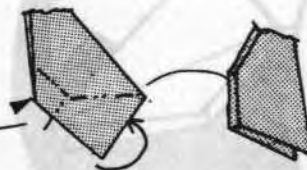
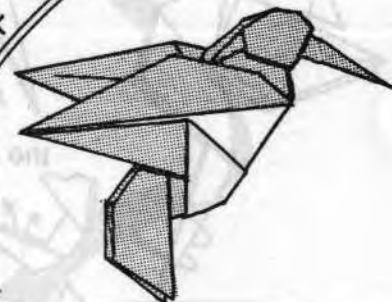
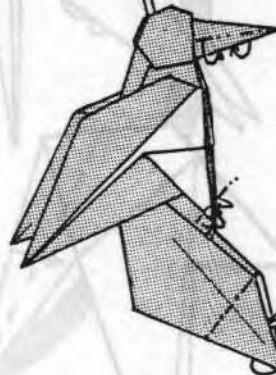

Swan John French

Gt. Britain

use a triangle (white)
see page 70

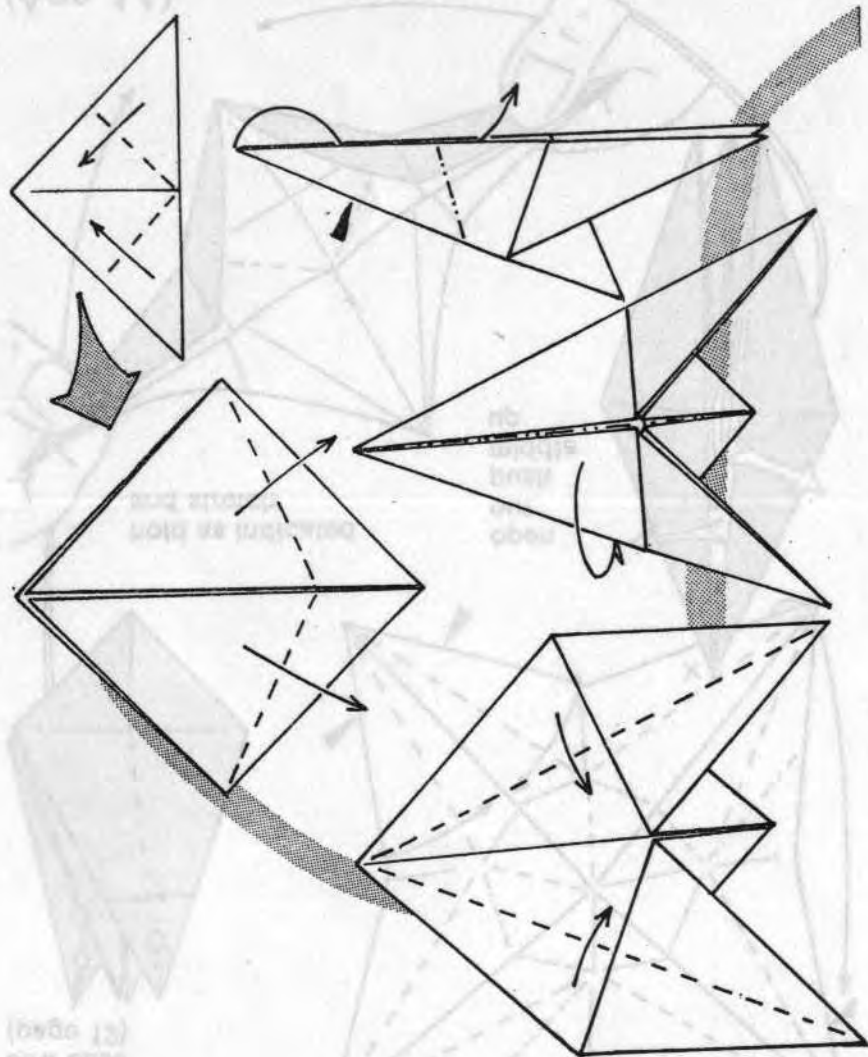

74

Swan concluded

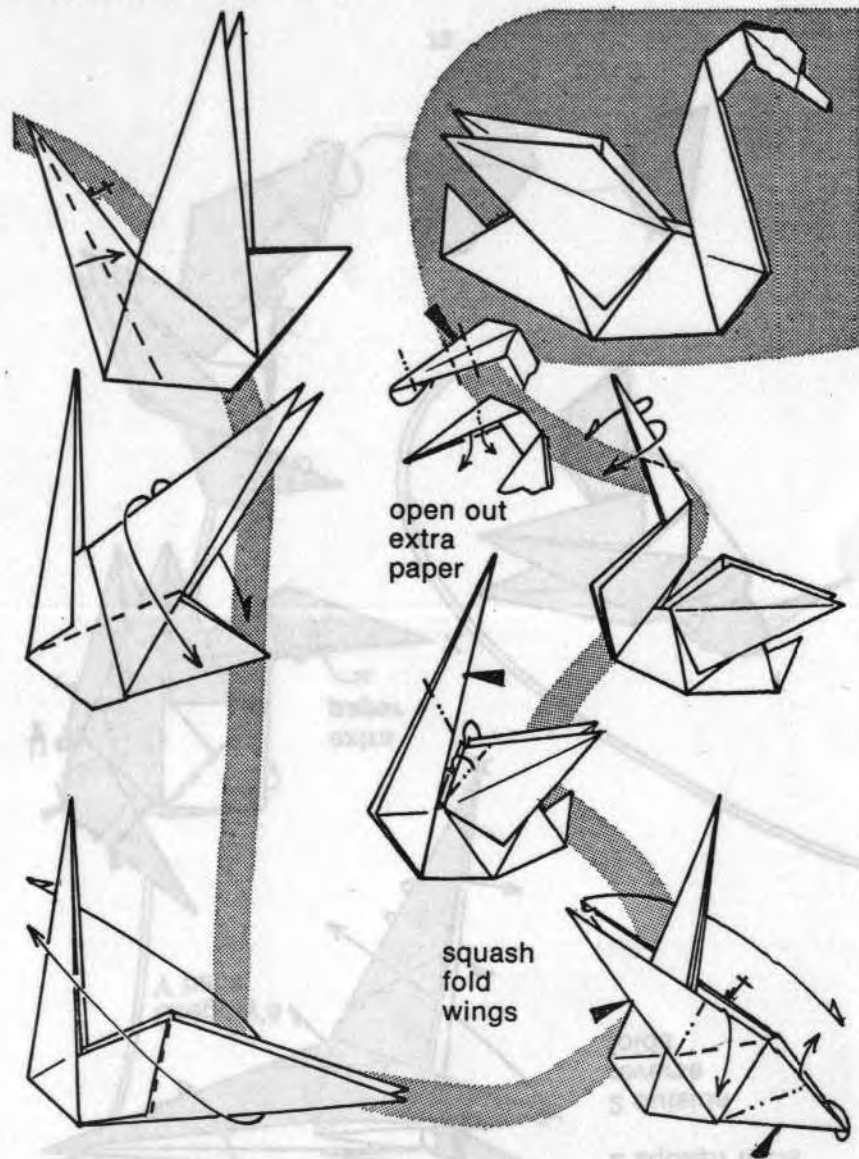

open out
extra
paper

squash
fold
wings

75

Siamese Cat Daniel Porter

U.S.A.

paper square grey one side
fold up to step 2 page 166
Origami 2 (U.S.A. New Adventures)

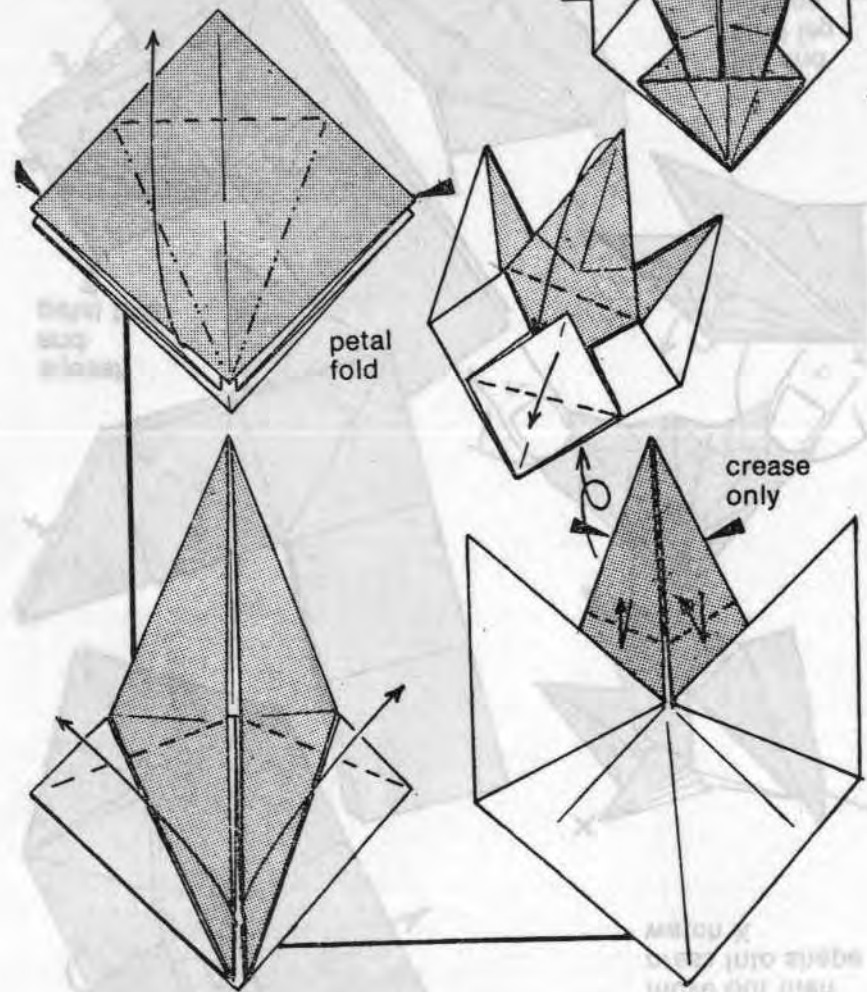

Elephant Neal Elias

U.S.A.

2 x 1 rectangle creased
with valley folds colour
under *Thin foil*

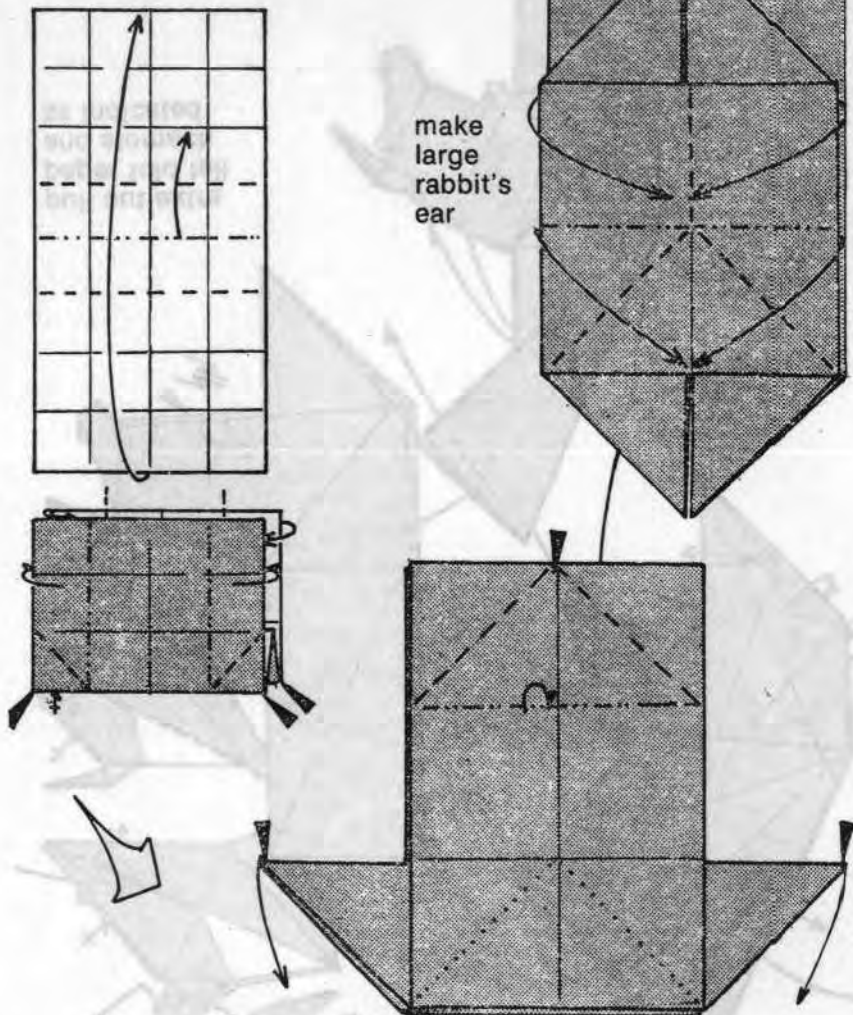

Elephant continued

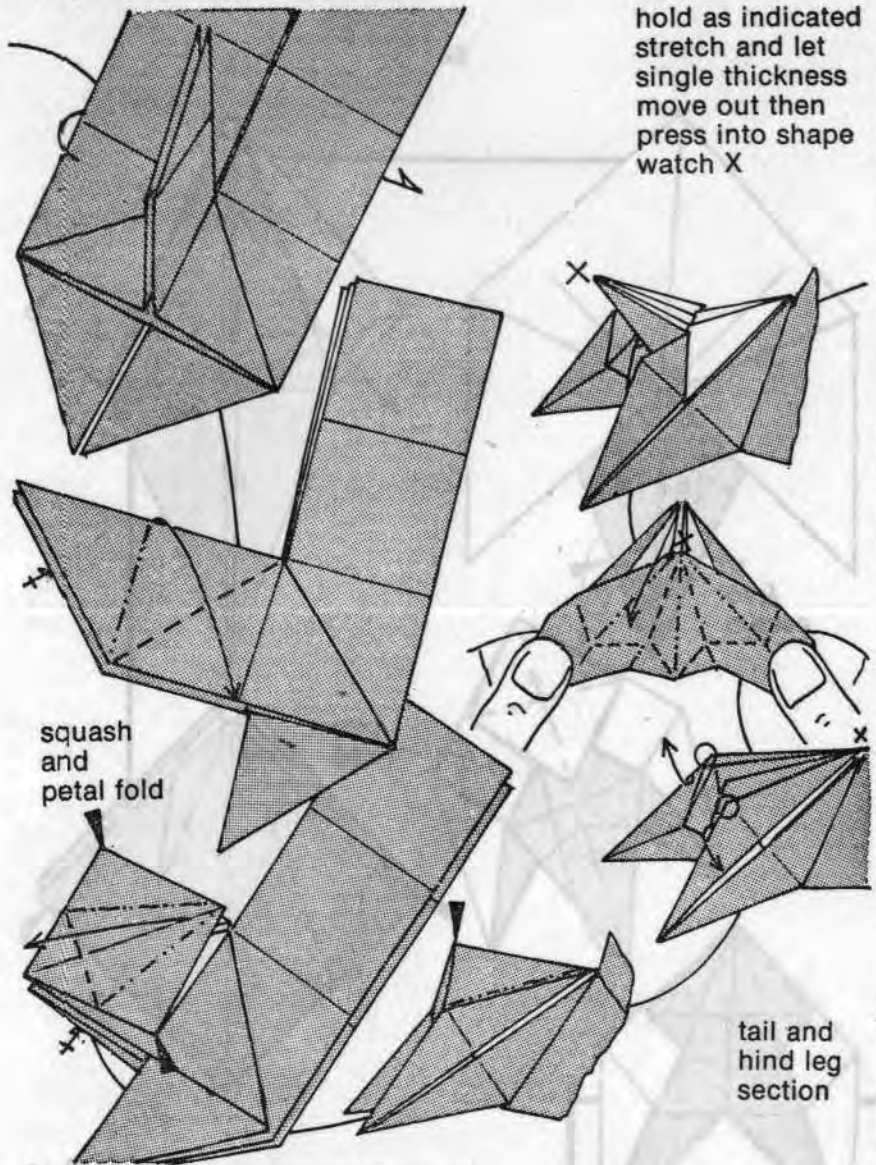

hold as indicated stretch and let single thickness move out then press into shape watch X

squash and petal fold

tail and hind leg section

Elephant continued

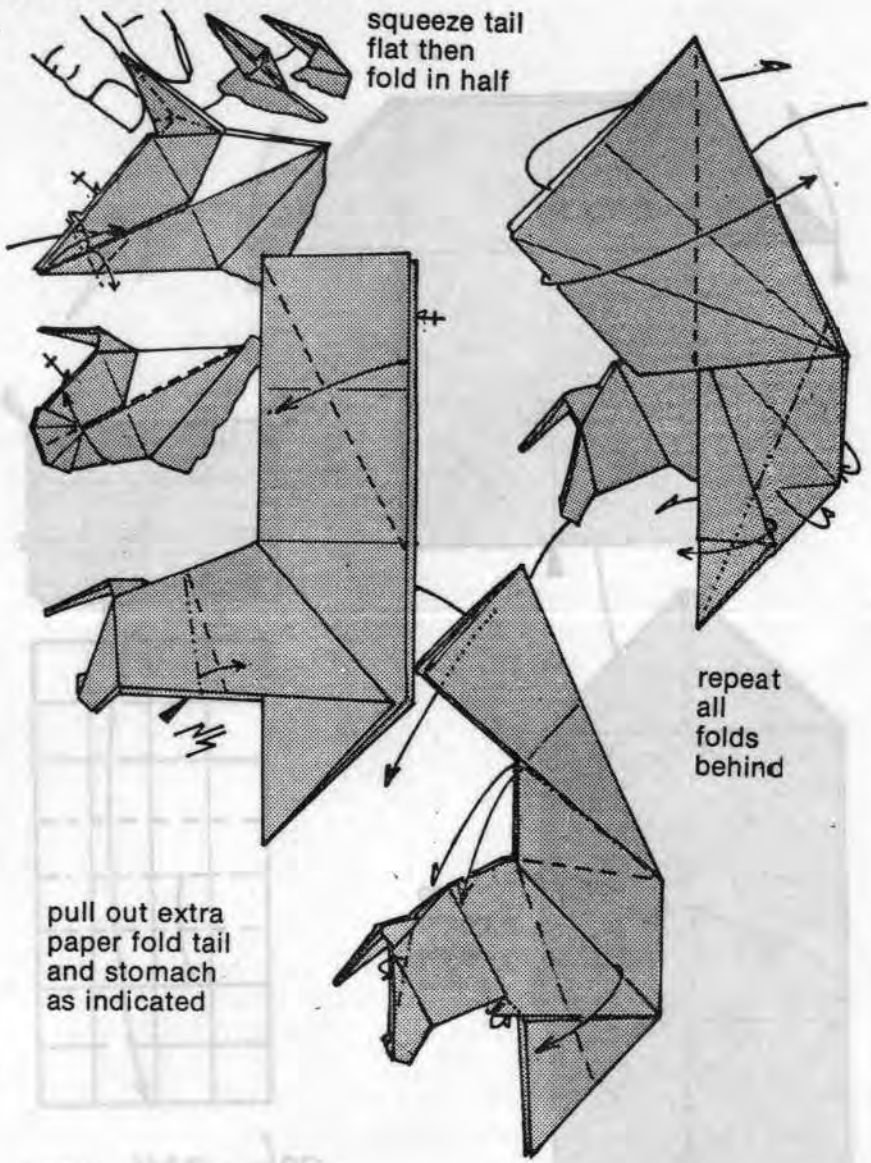

squeeze tail flat then fold in half

pull out extra paper fold tail and stomach as indicated

repeat all folds behind

Elephant continued

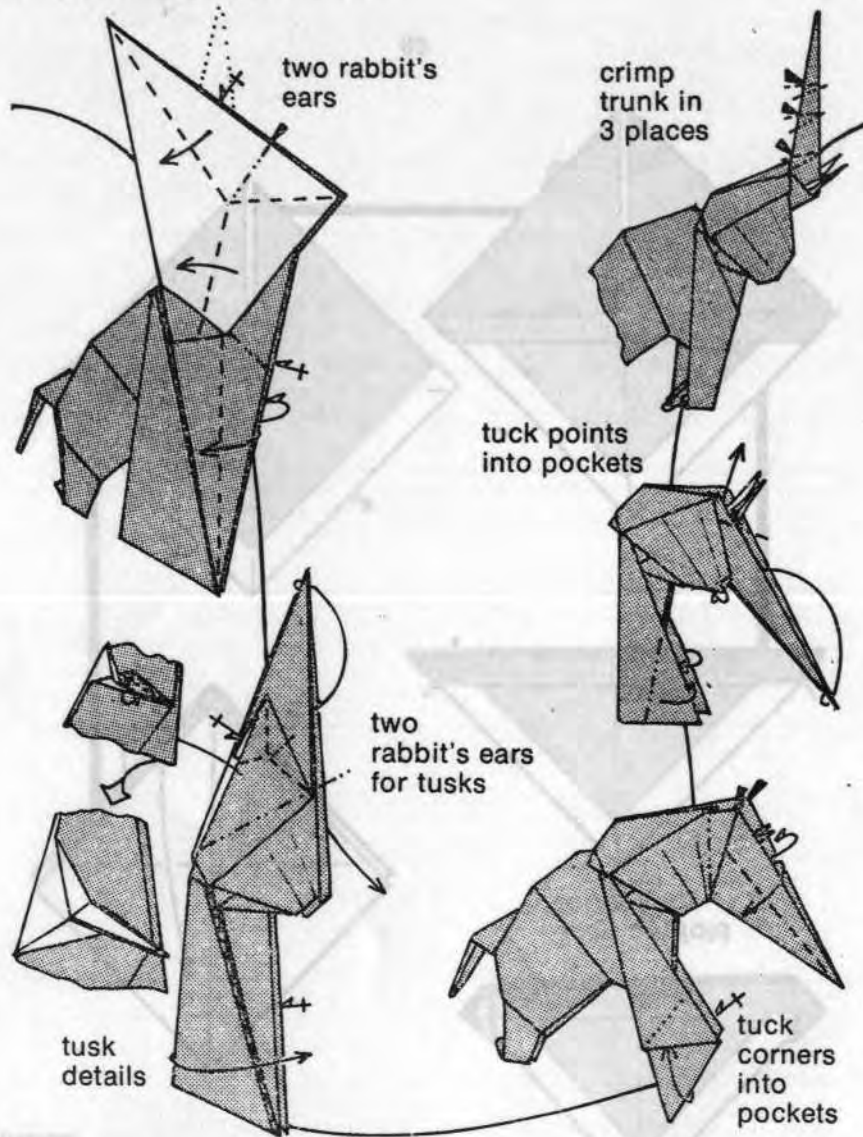

Elephant concluded

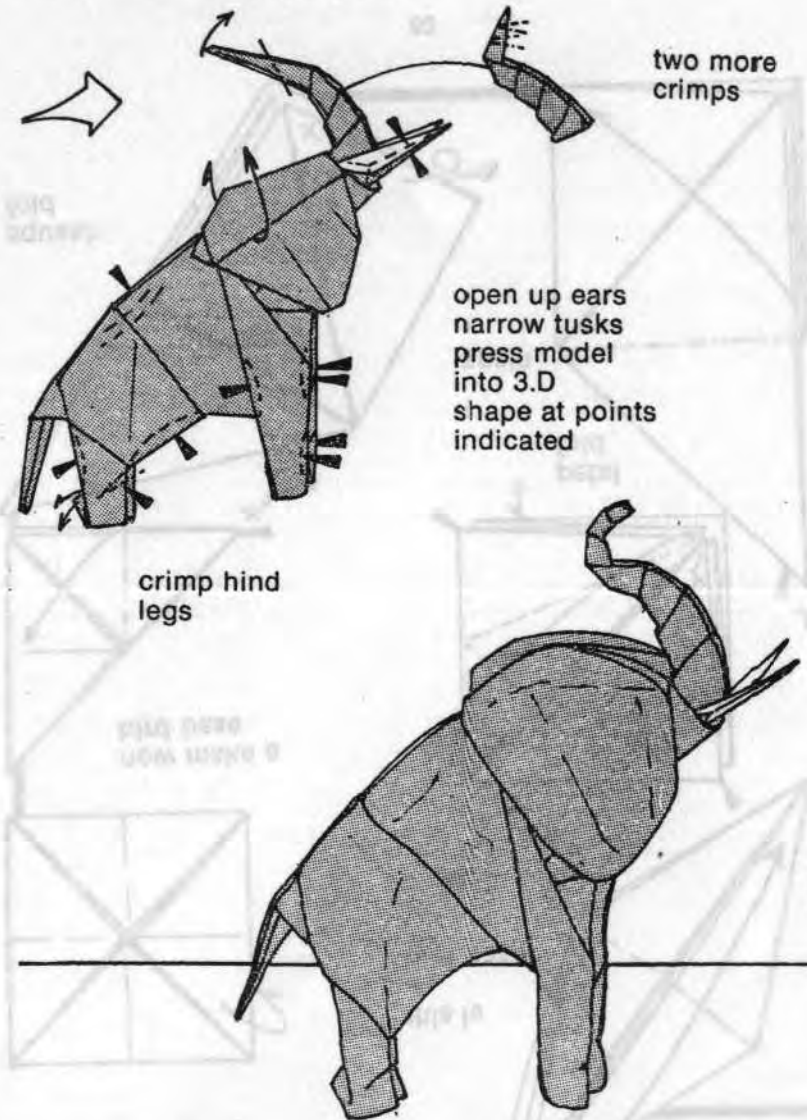

Hat Robert Harbin

Gt. Britain

begin with a preliminary base page 11 colour inside

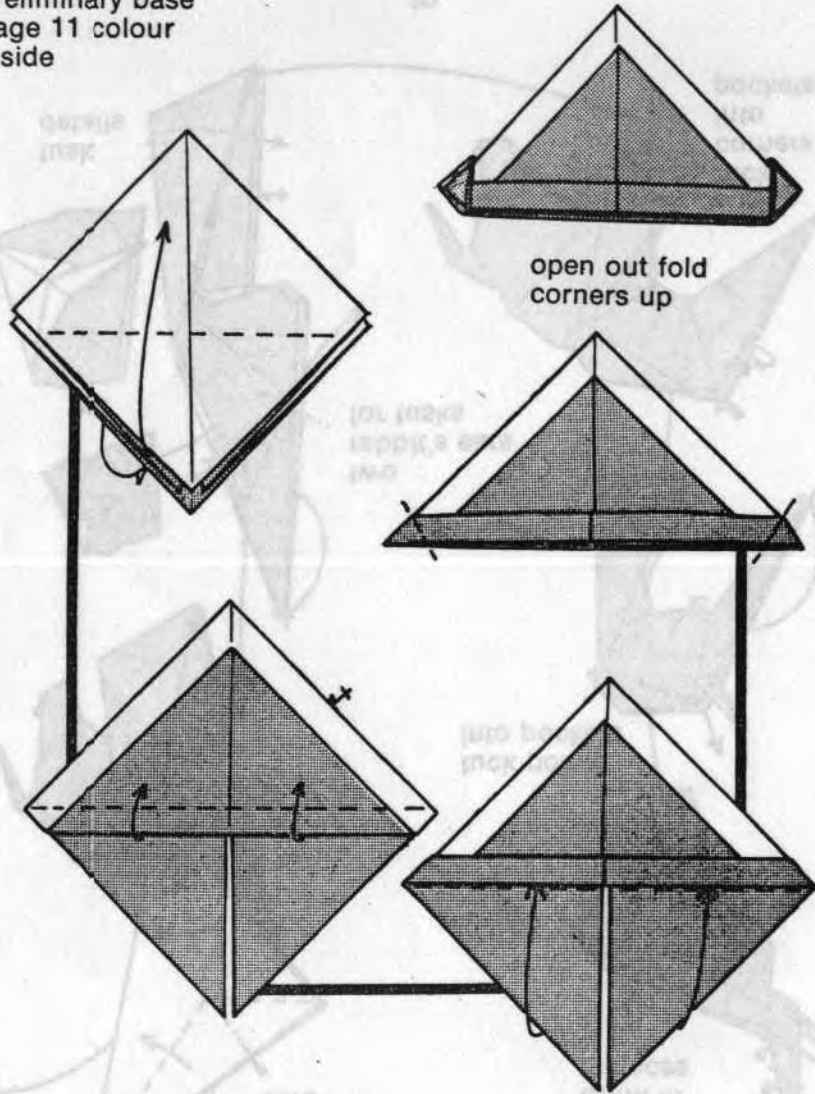

82

Baby Grand Patricia Crawford

U.S.A.

a square of foil four corners folded to the centre (Blintzed)

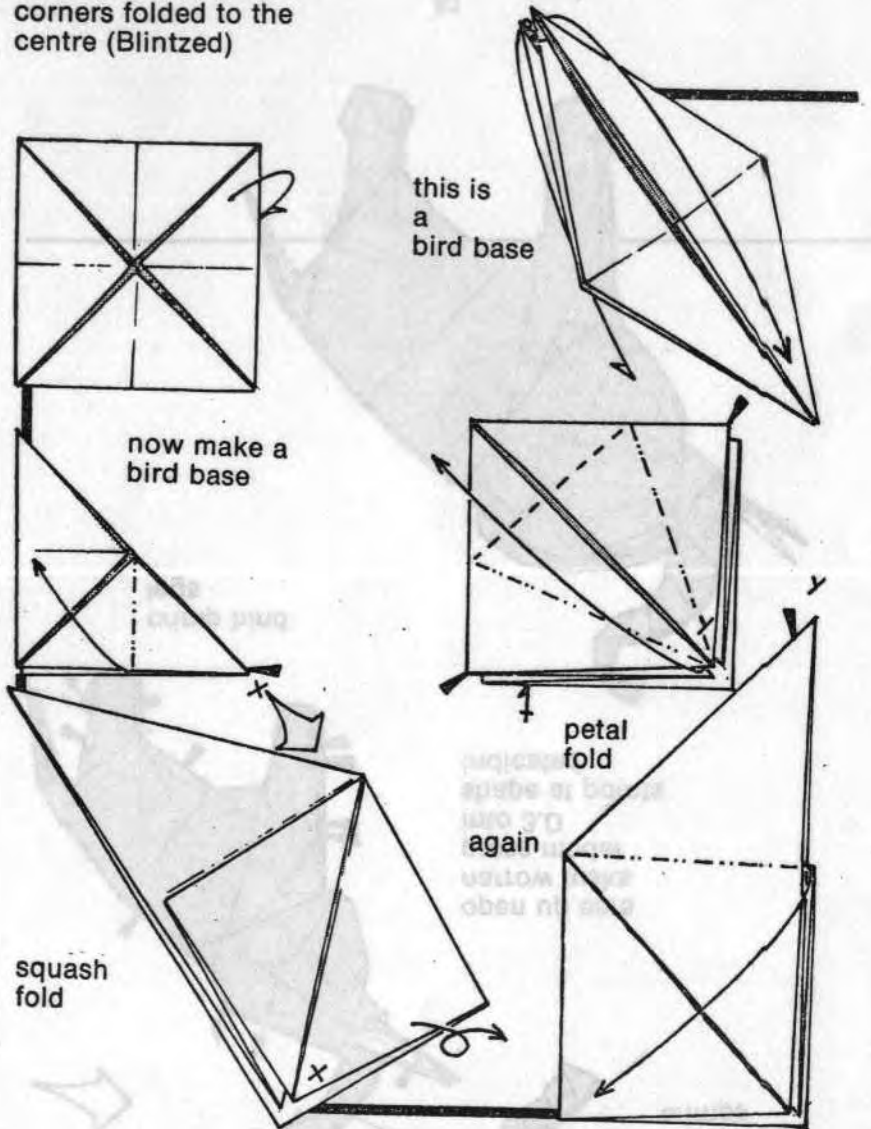

83

Baby Grand continued

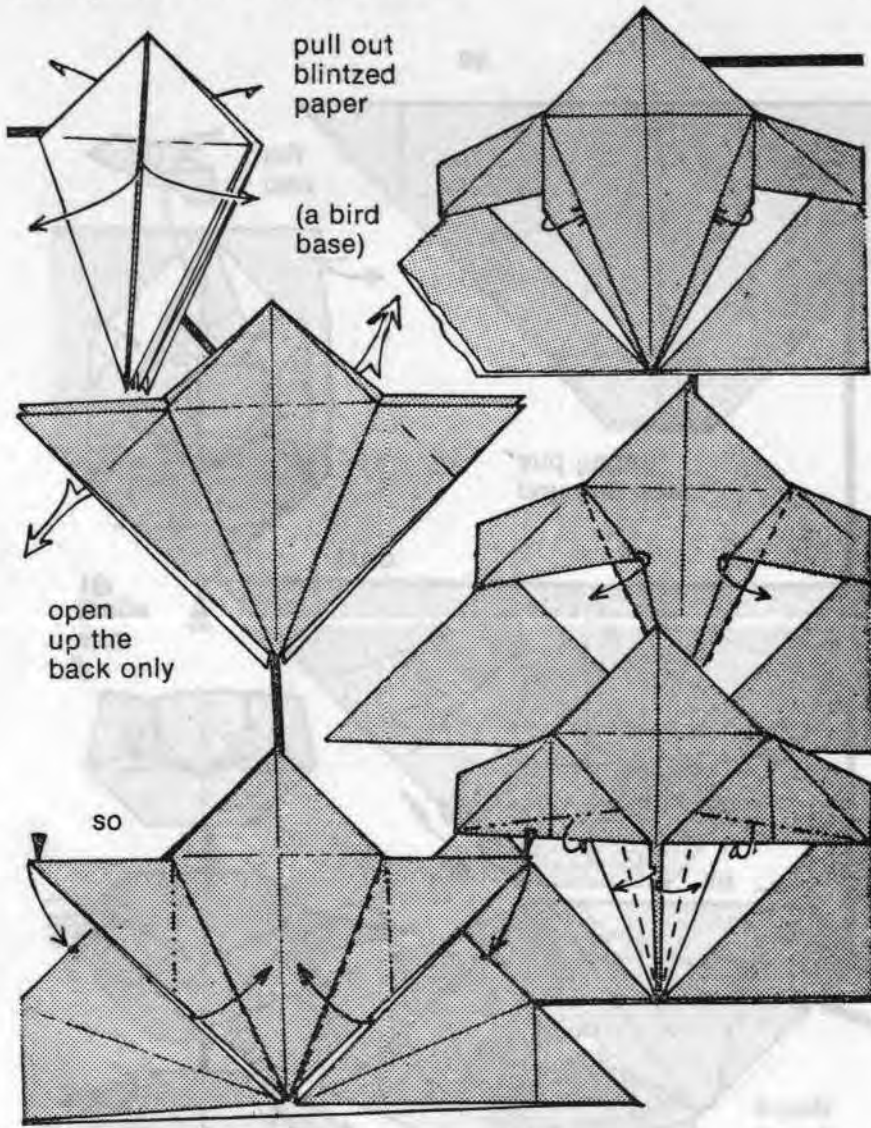

Baby Grand continued

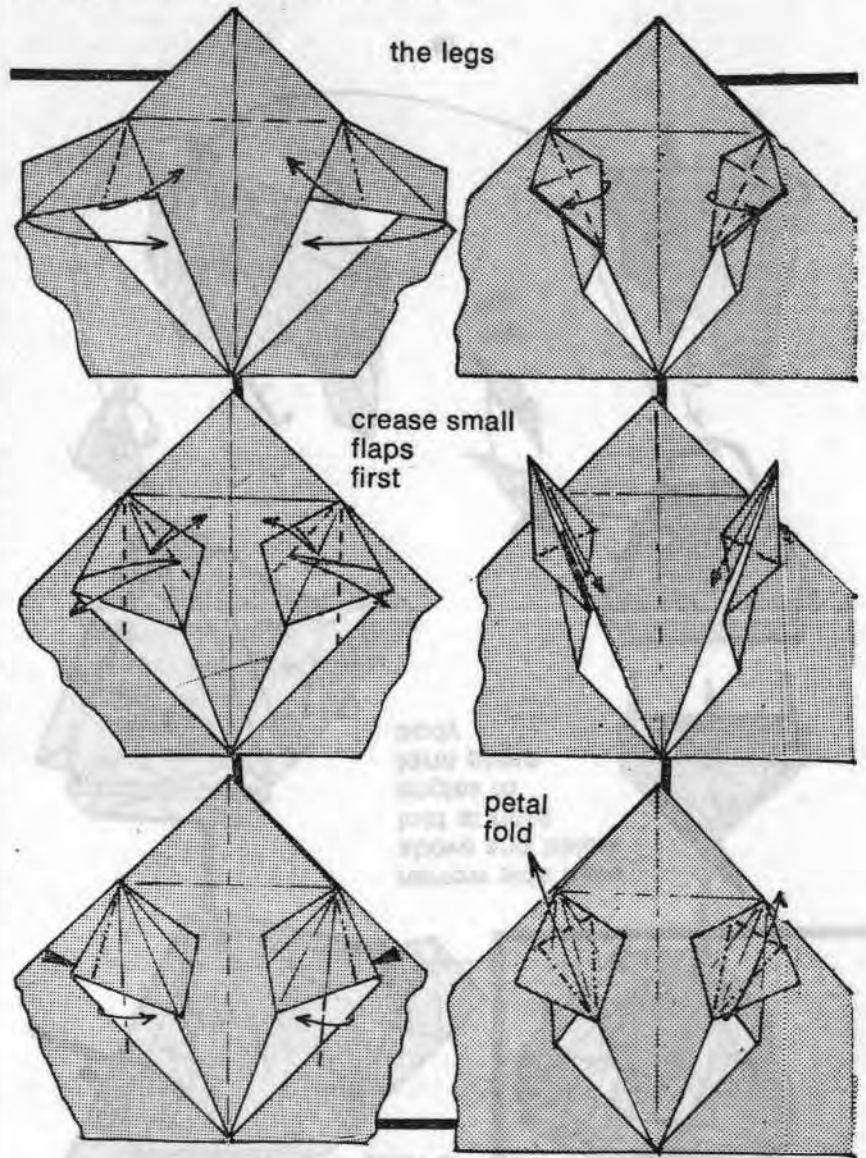

Baby Grand continued

It is easy really

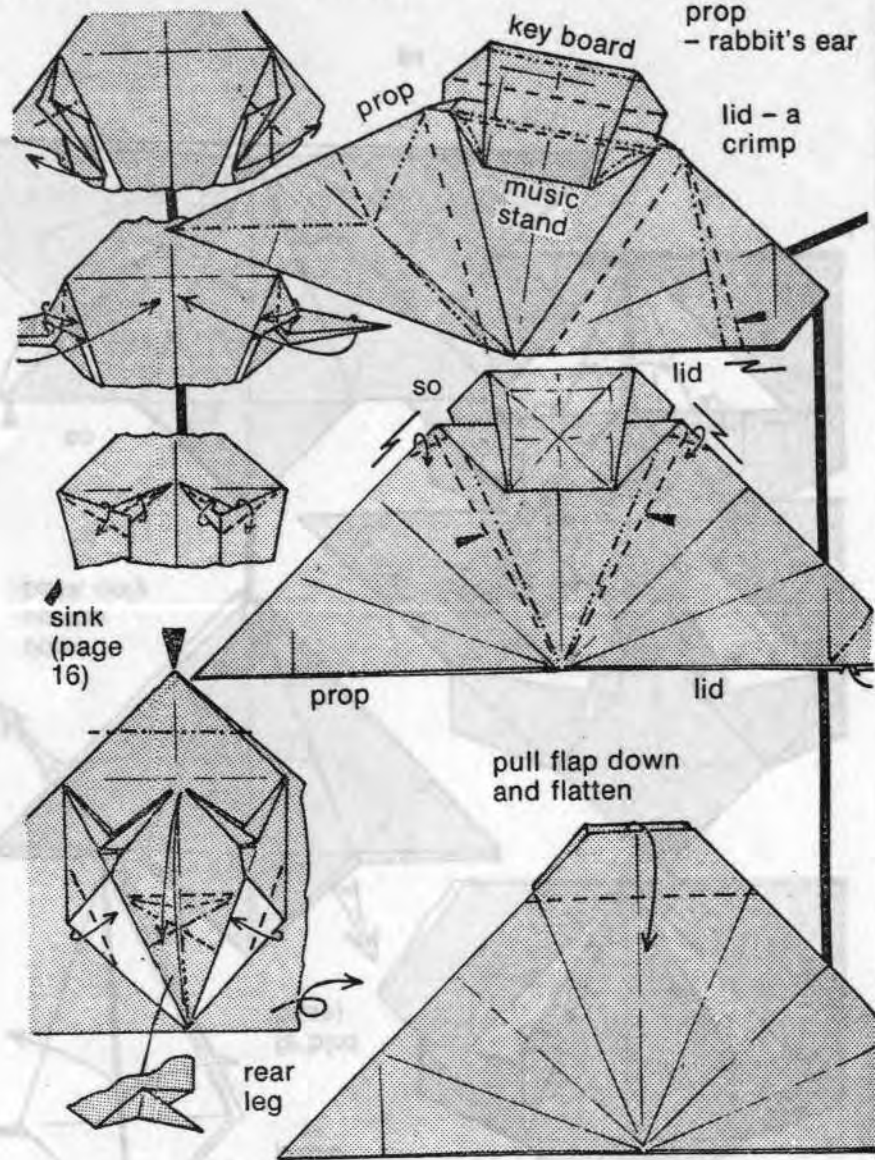

Baby Grand concluded

A great fold

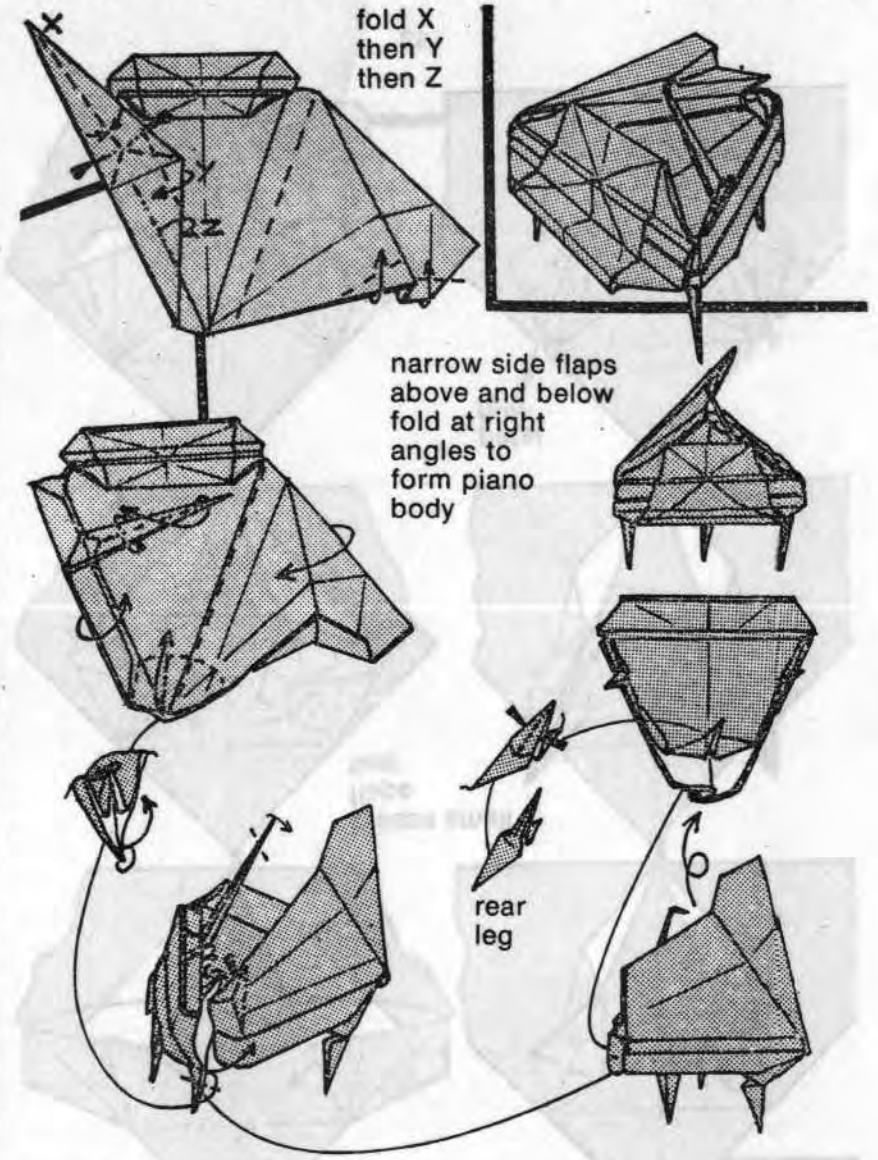

Baby Penguin Joel Stern

use a square
black one
side and
a bird base
(pages 11 and 12)

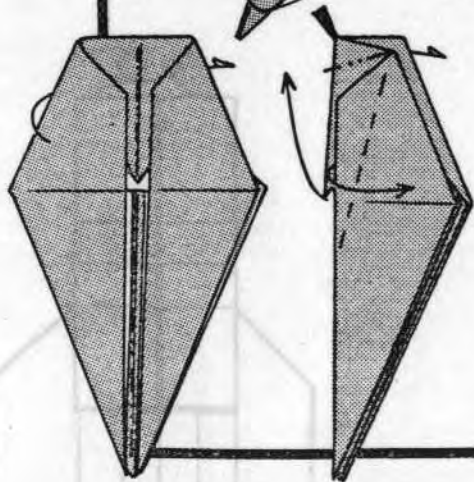
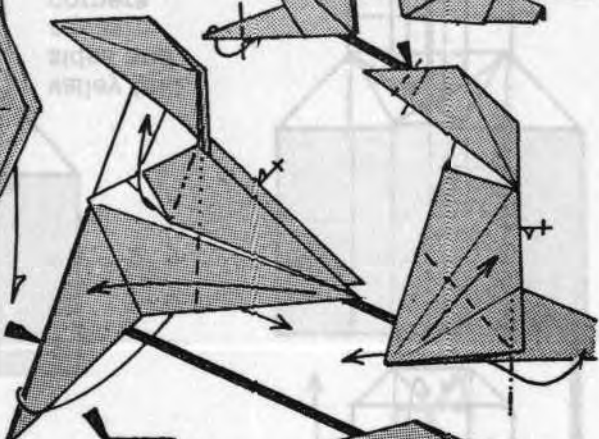
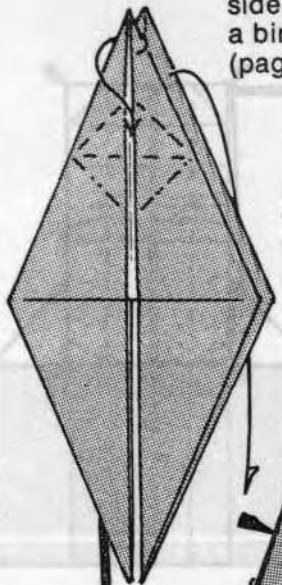

two
squash
folds

U.S.A.

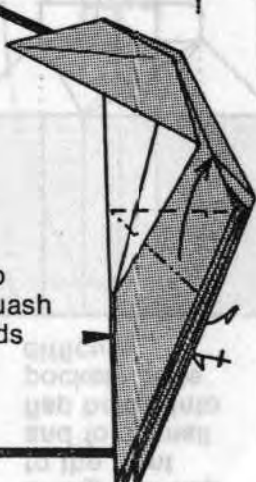
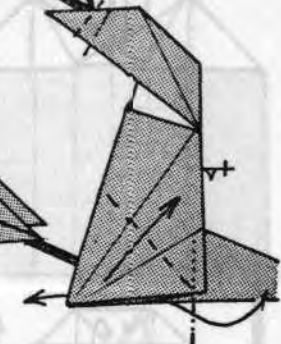
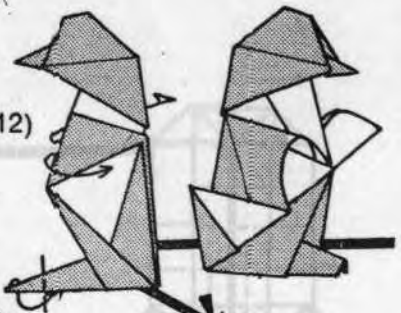

Match Box Martin Wall

use a 8 x 24 rectangle
crease as indicated
make mountain fold
use foil

*Model 5x2+1
when closed!*

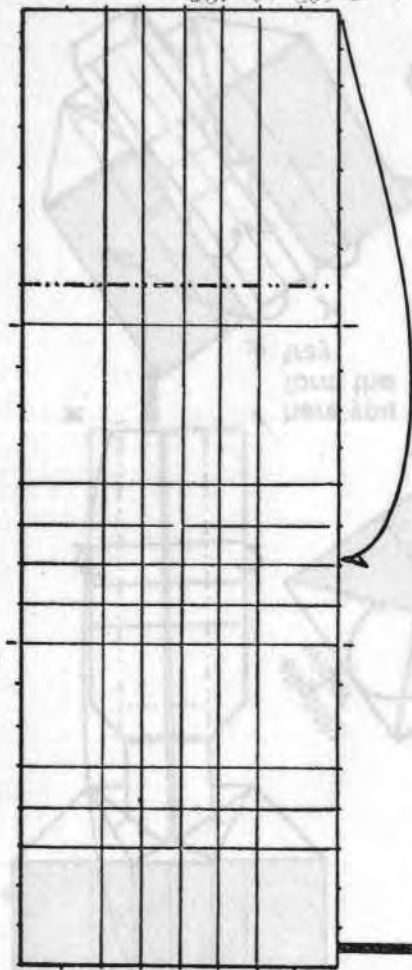

Gt. Britain

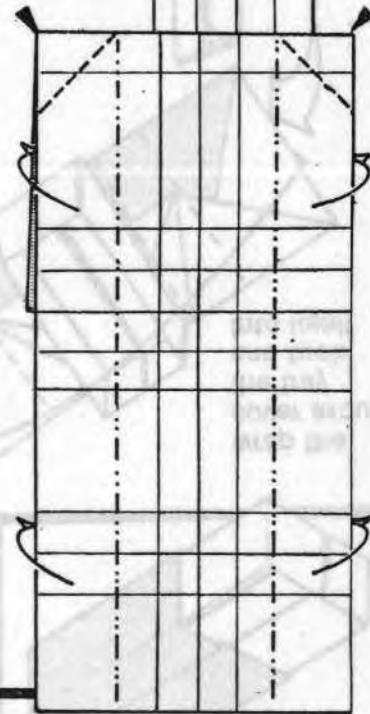
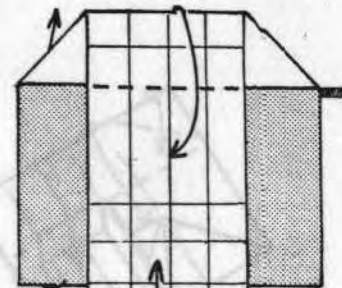

Match Box continued

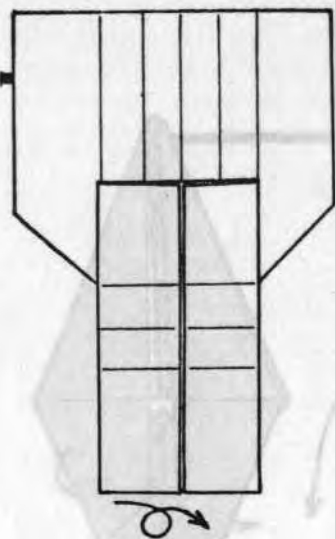

swing rear flap to the front and fold small flap below into pockets quite difficult

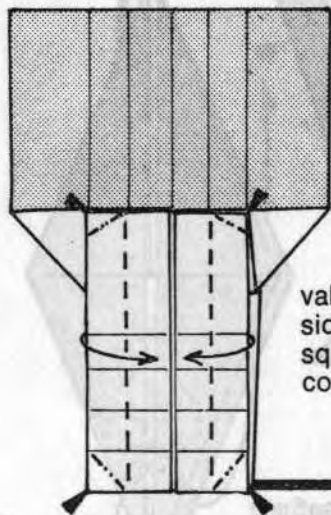
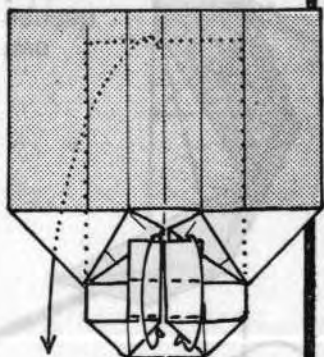

valley fold sides and squash corners

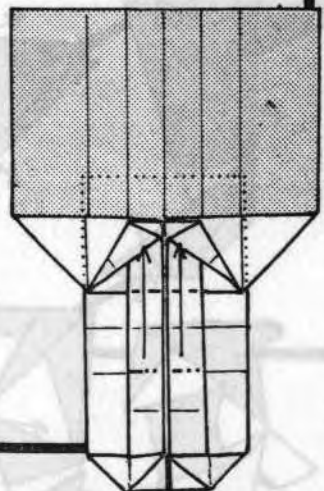

Match Box Presto! The tray pushes in and out!

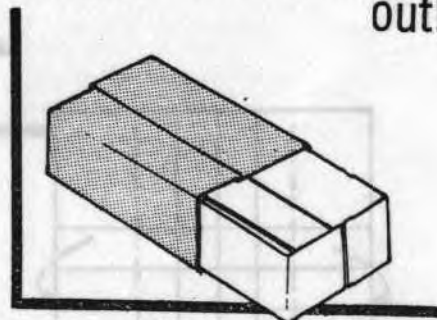
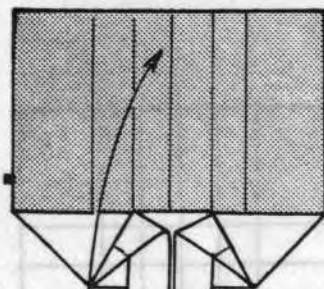

slightly wider

wrap the cover around the tray and tuck into itself

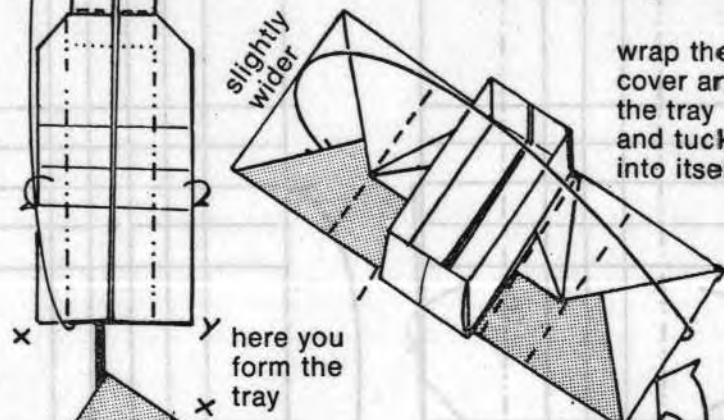

here you form the tray

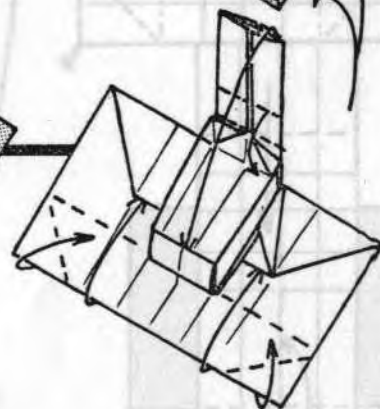
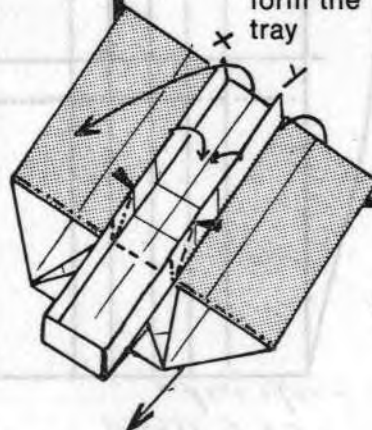

Hand with Olympic Torch

Martin Wall

Gt. Britain

4 x 12 rectangle brown one side. Crease as indicated and make two crimps

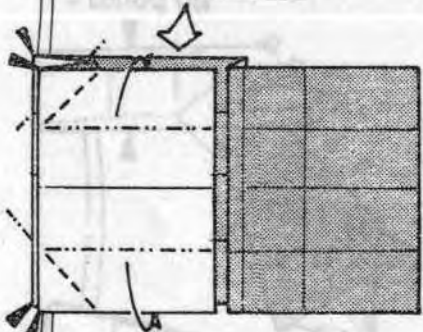
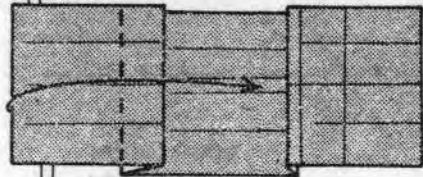
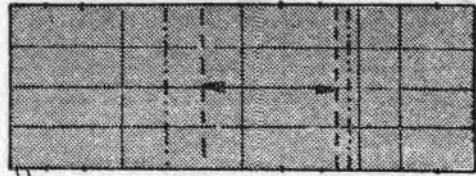

sink rear corners mountain fold sides pulling corners in

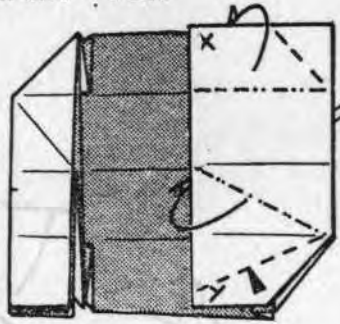
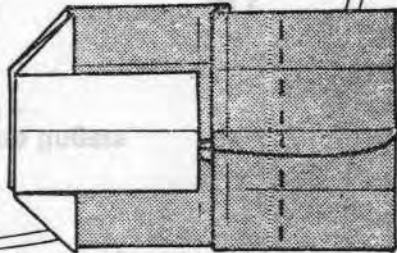

fold X then Y see next two folds

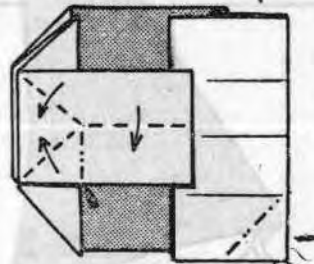

rabbit's ear

Hand with Torch continued

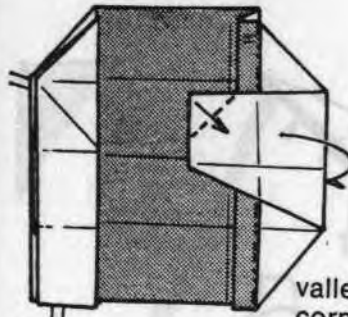

valley fold corner swing flap behind

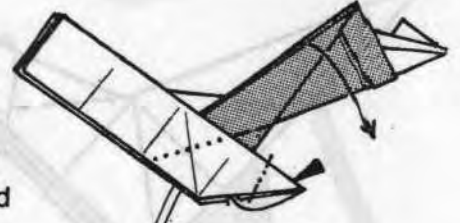
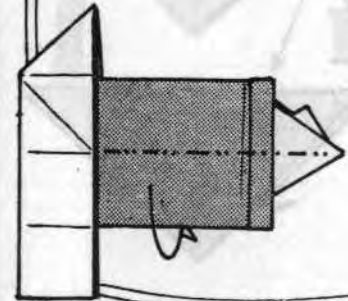
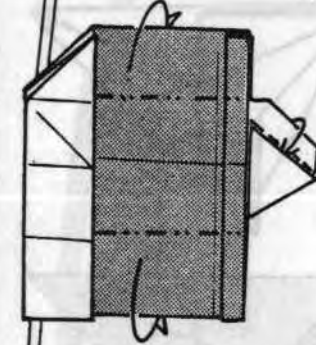

reverse fold

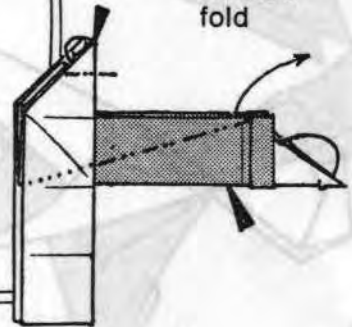
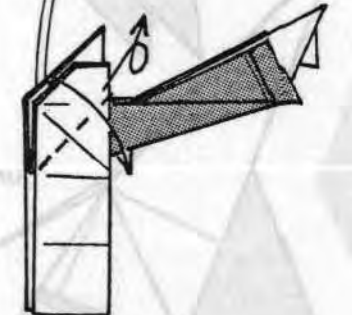

Hand with Olympic Torch

Olympian

Flapping Bird Paul Jackson

Gt. Britain



form flame by creasing and pinching into shape

crimp fingers and -

- round off finger ends

begin with a waterbomb base page 9 colour out

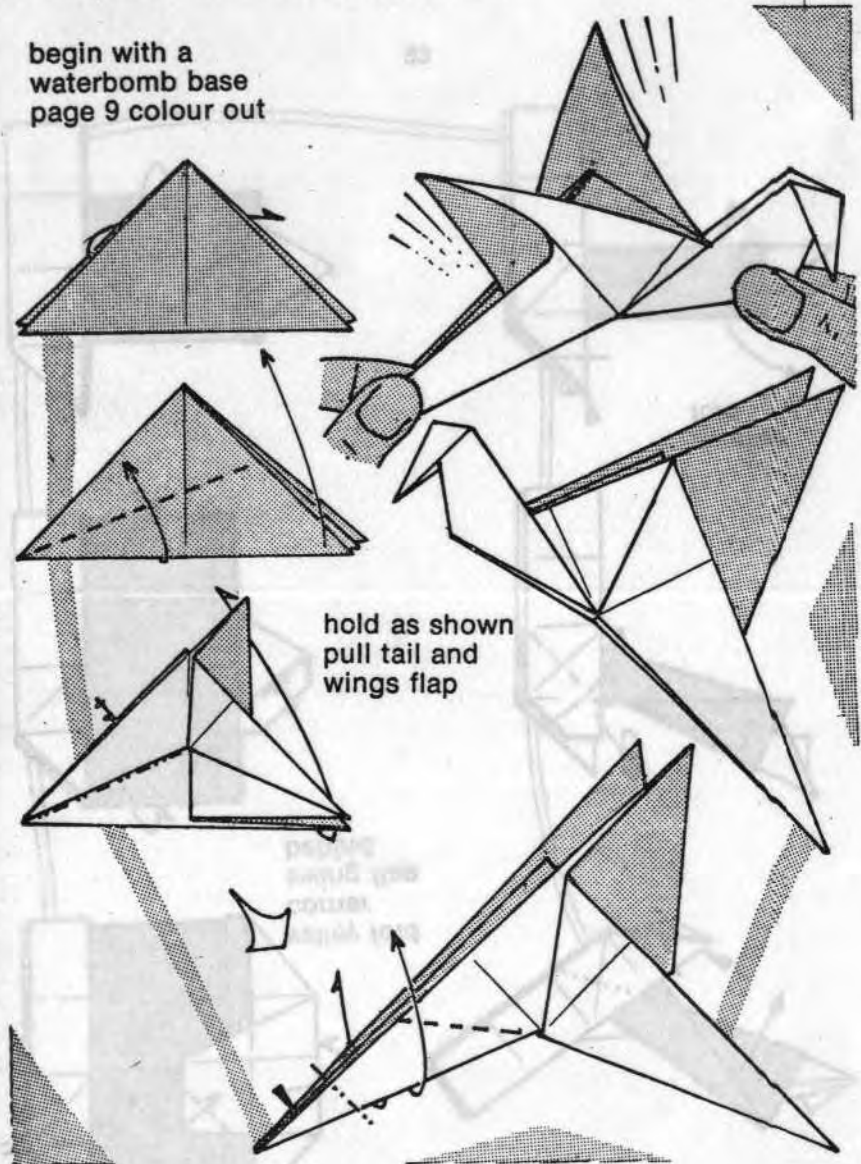

hold as shown pull tail and wings flap

Rose Martin Wall

use a square of red foil white side coloured green. Begin with a preliminary base

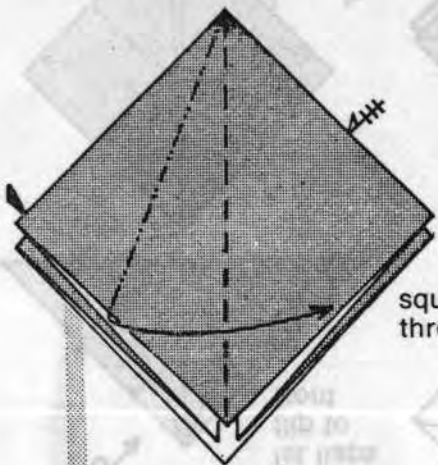

squash fold three times

repeat this fold on the three similar sides

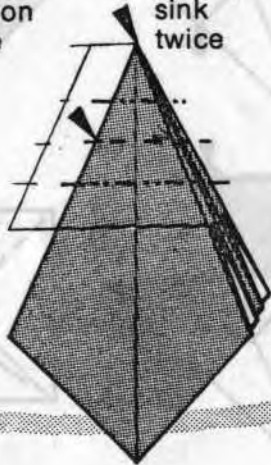
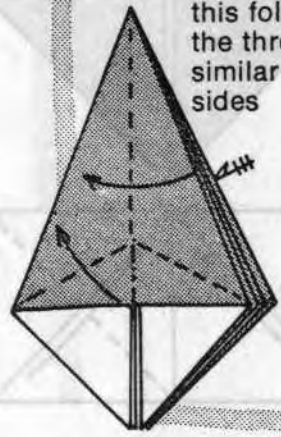

crease heavily sink twice

Gt. Britain

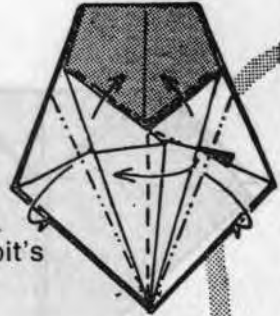

rabbit's ear

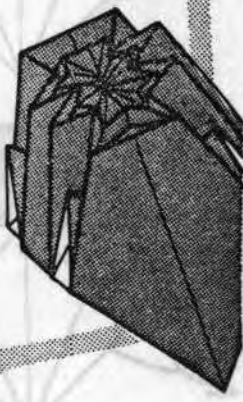
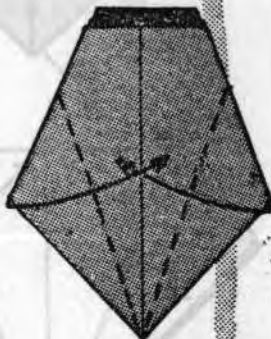

Rose concluded

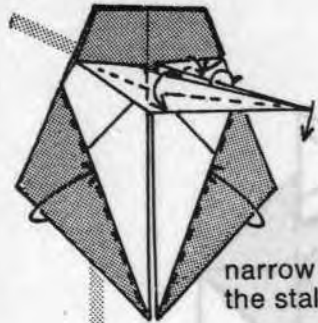

narrow the stalk

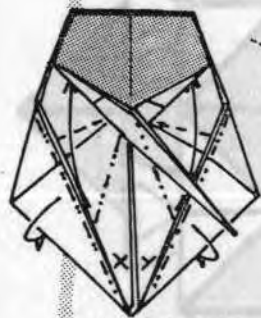

squash fold two leaves X and Y

so

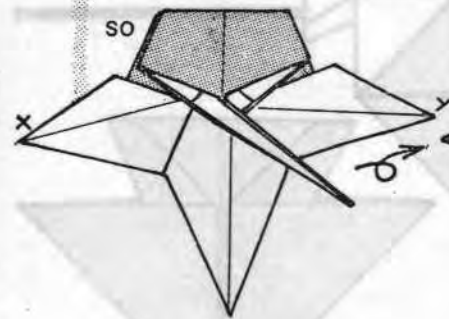

Beautiful

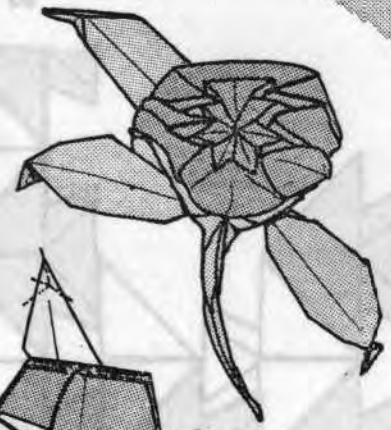

rabbit's ear three leaf tips open rose

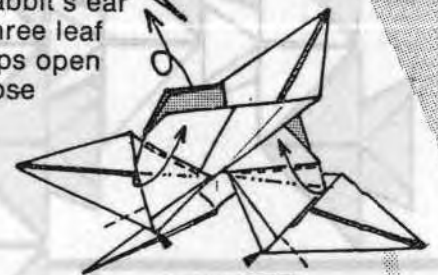

an eccentric rabbit's ear

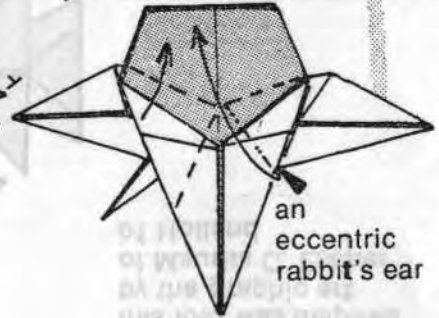

Escher Mick Guy

Gt. Britain

2 x 1 rectangle
white side up

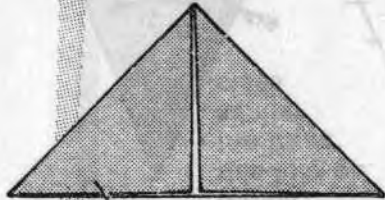
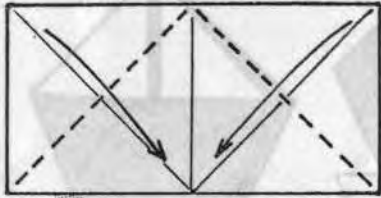

let flaps
flip to
front

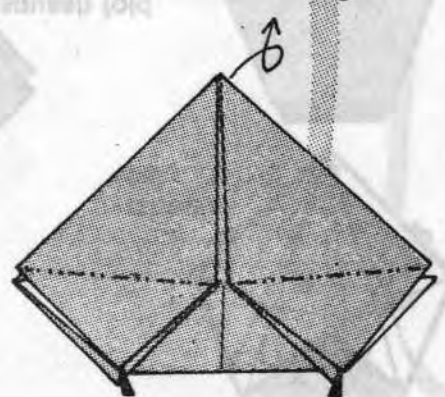
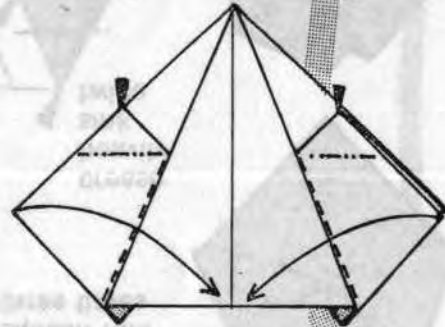
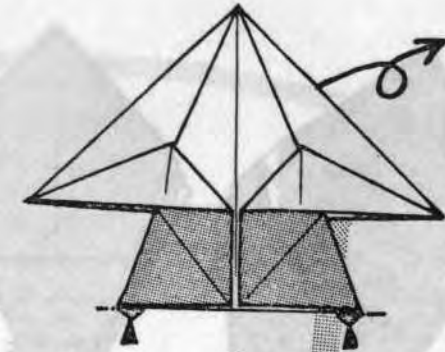
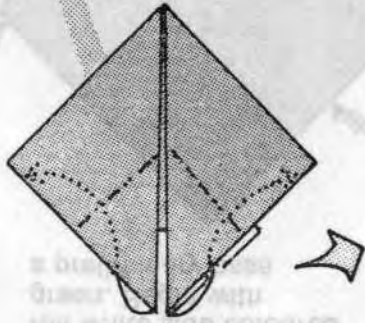
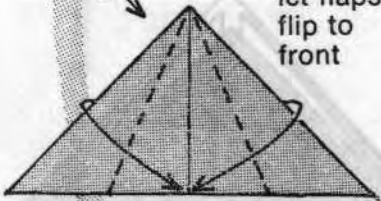

Escher concluded

most ingenious
this fold was inspired
by the graphic art
of Maurits C. Escher
of Holland

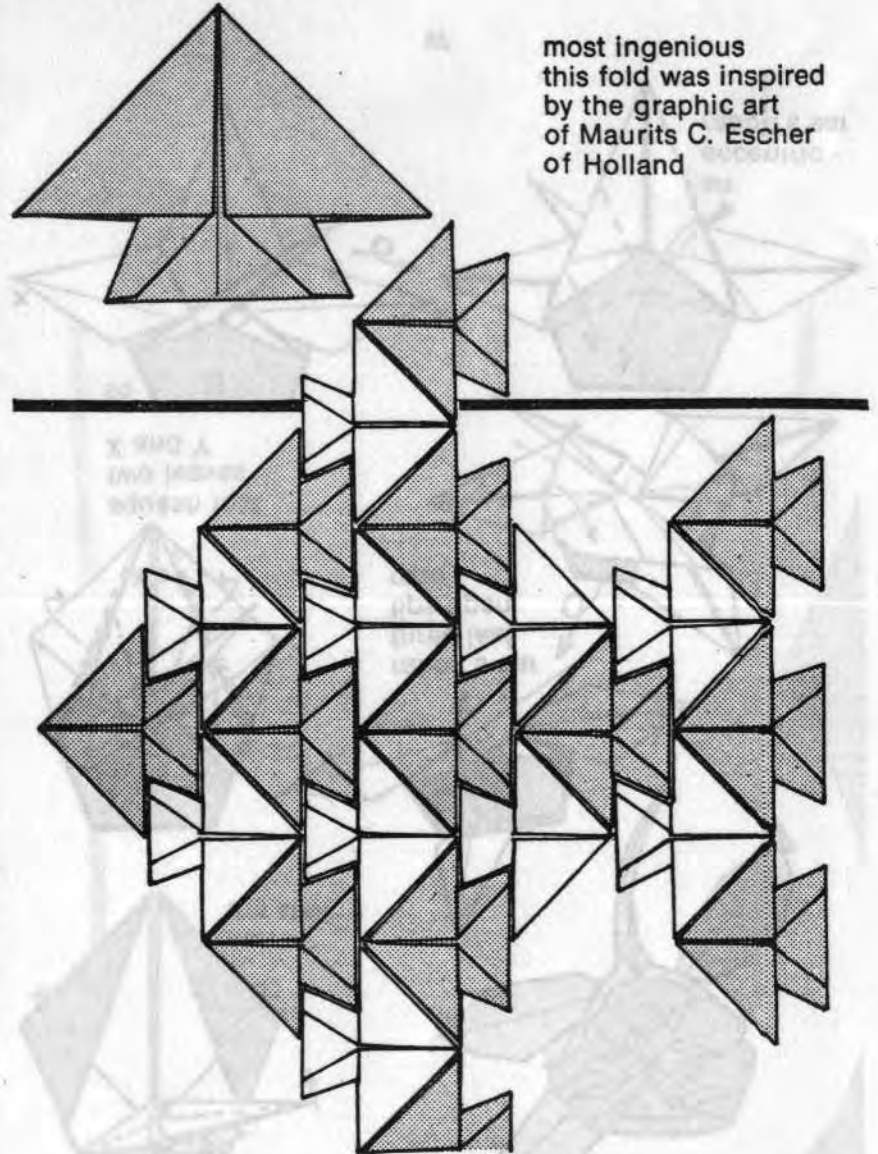

Baby Chick Paul Jackson

Gt. Britain

use a square yellow
one side, make creases
shown

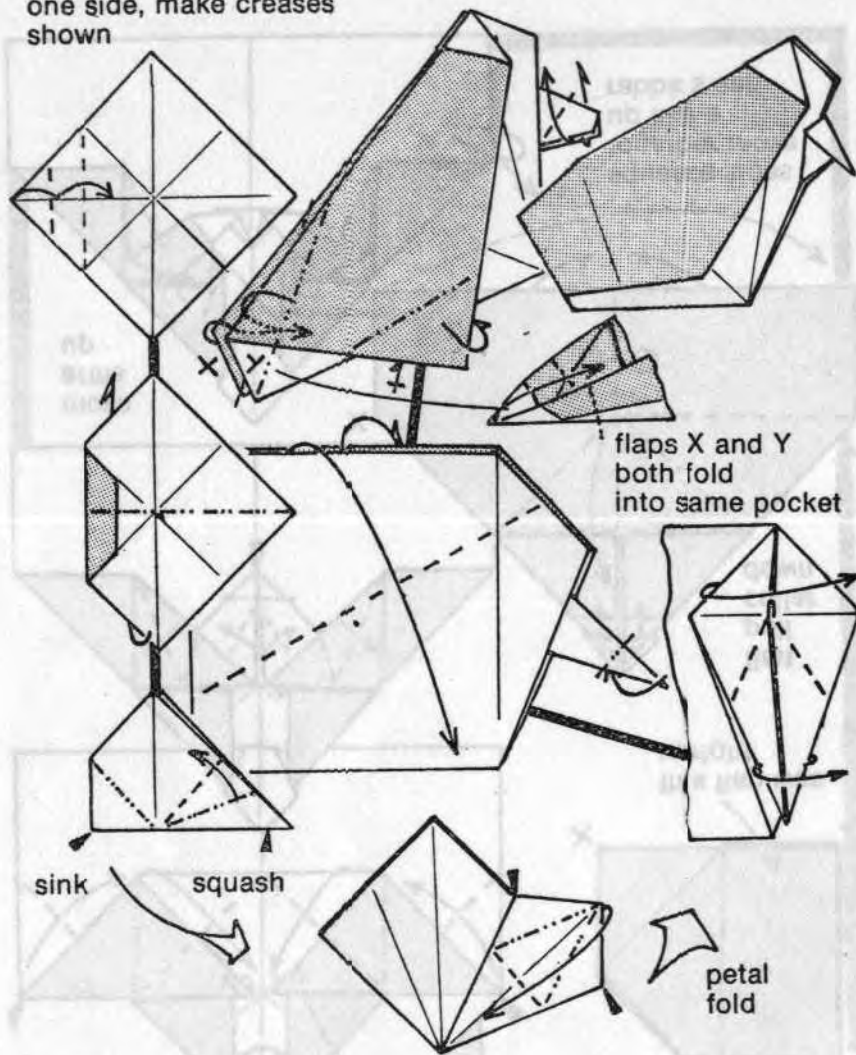

Buddah (3.D) Neal Elias

U.S.A.

3 × 2 rectangle creased
mountain down middle
valley diagonals
use foil

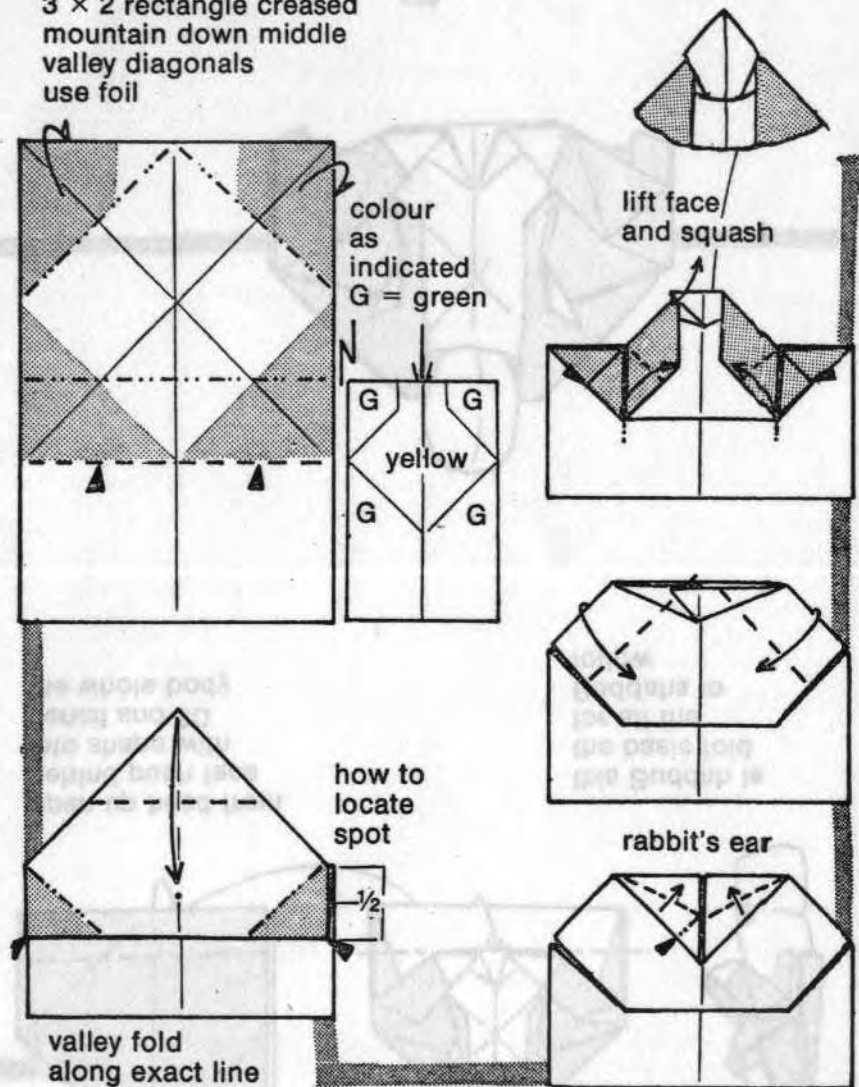

Buddah continued

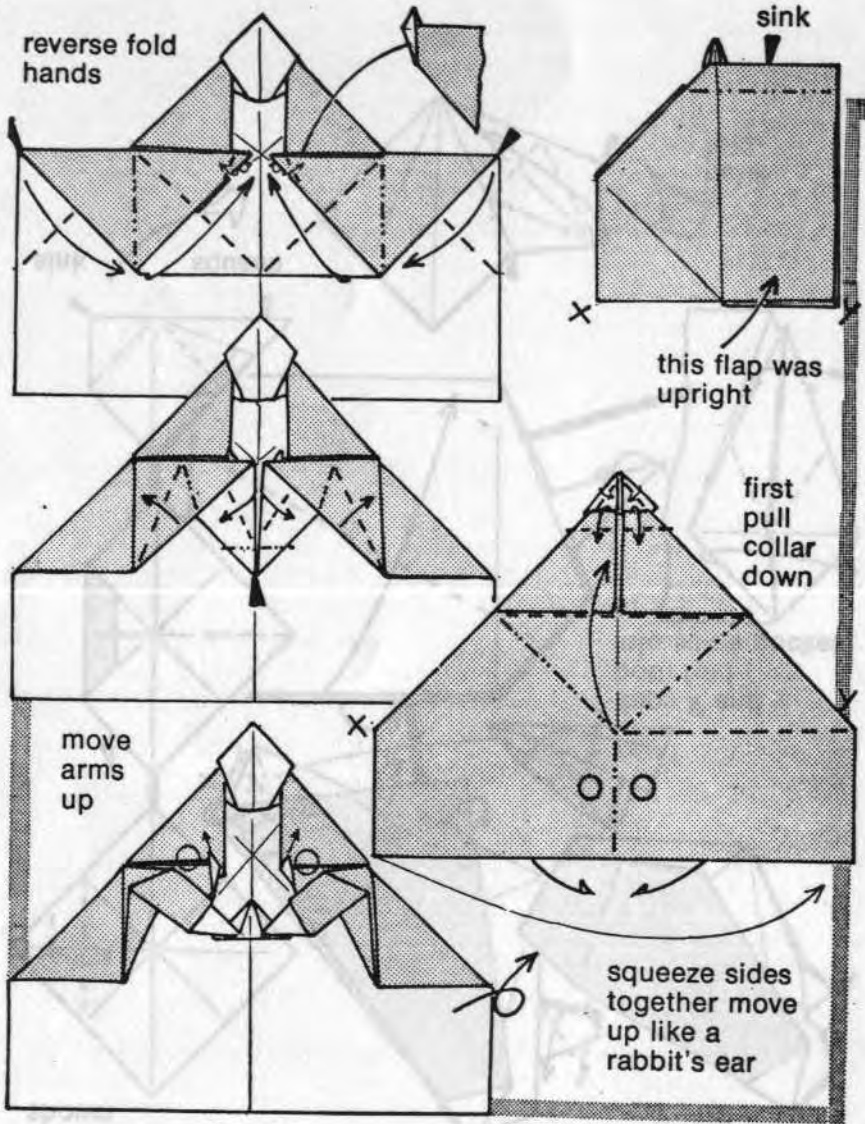

Buddah concluded

A little gem

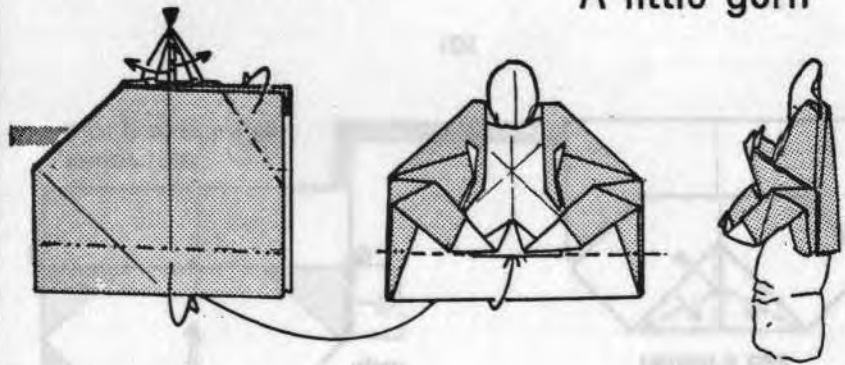

open up head from behind push face into shape with pencil and 3D the whole body

this Buddah is the basic fold for all the Buddahs to follow

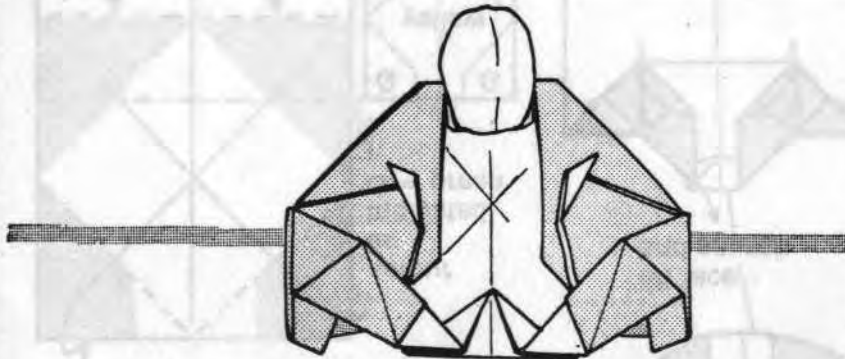

Turtle Neal Elias

use a square green
one side fold sides
to the middle crease
and sink four corners
use foil

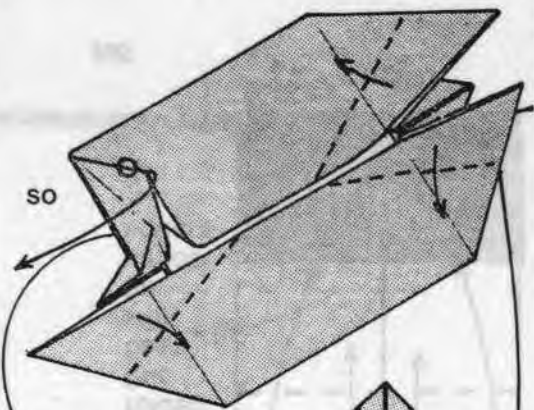
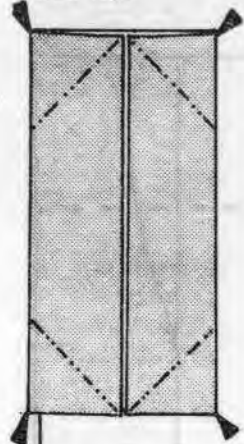

now lift out
the four corners
and replace
over head
and tail
folds

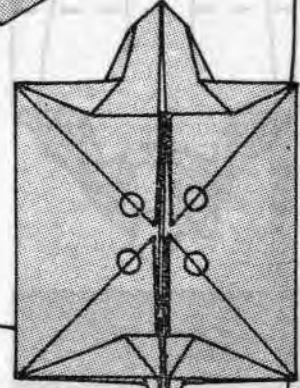
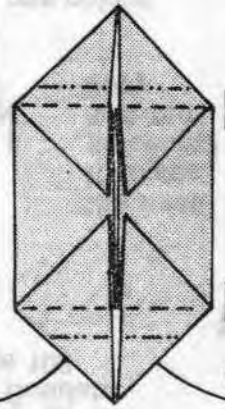
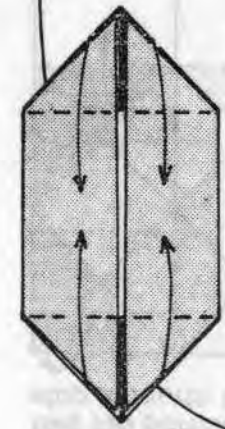

head

tail

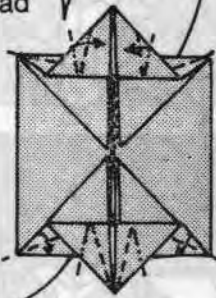

U.S.A.

Turtle concluded

To be used elsewhere

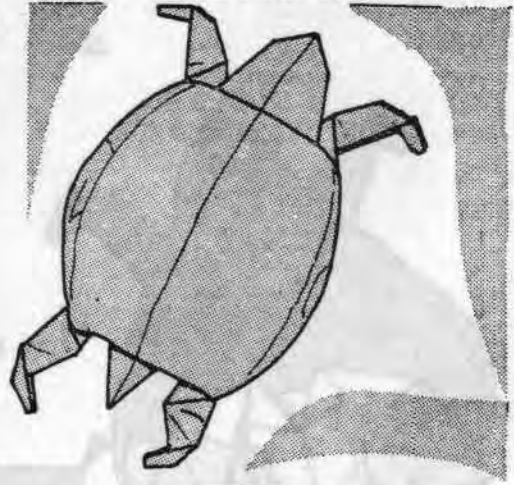
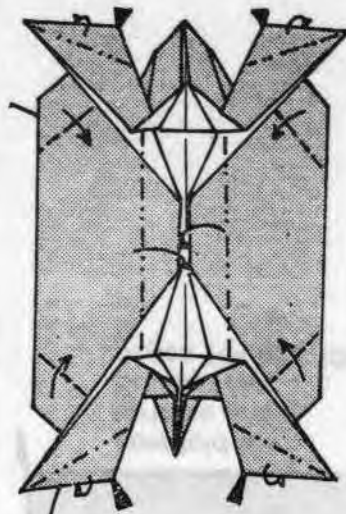

with a
pencil or
other aid
make
turtle
3D

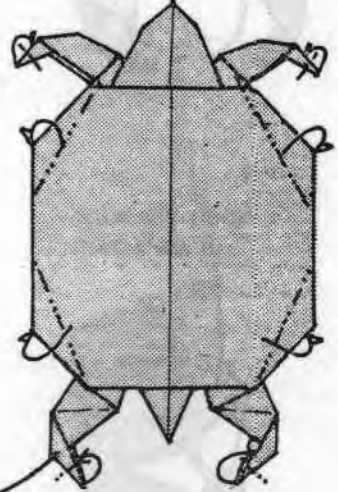
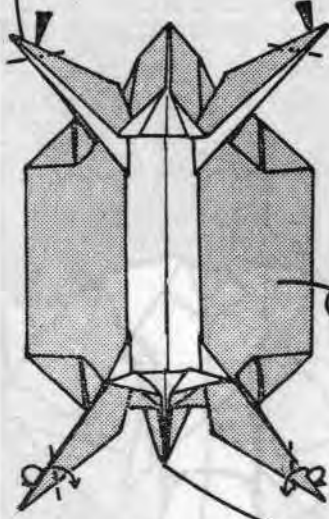

Buddah on Tortoise (Uras Him Ataro) Neal Elias

3 x 1 rectangle creased as indicated coloured see page 101
fold top portion into a Buddah
stop at fourth fold page 102

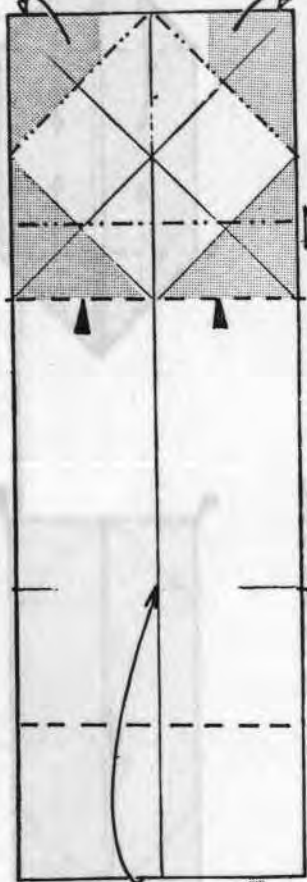

the small triangles go behind and into body

one colour difference gold underneath

when folded this base will be almost square

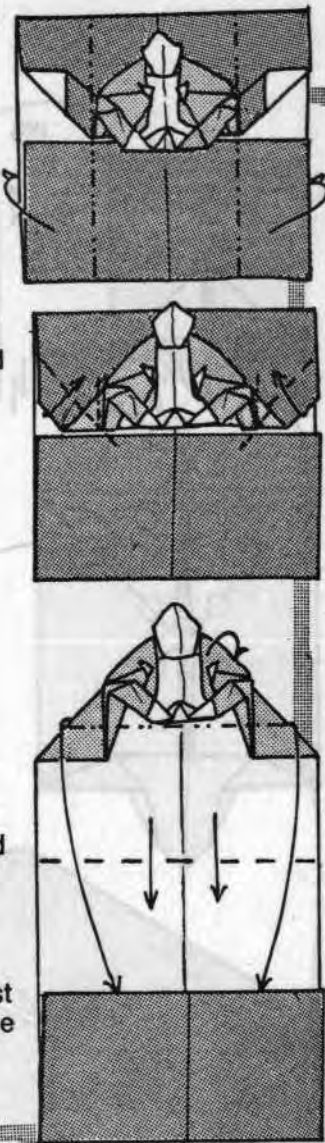

U.S.A.

Buddah on Tortoise

Another gem

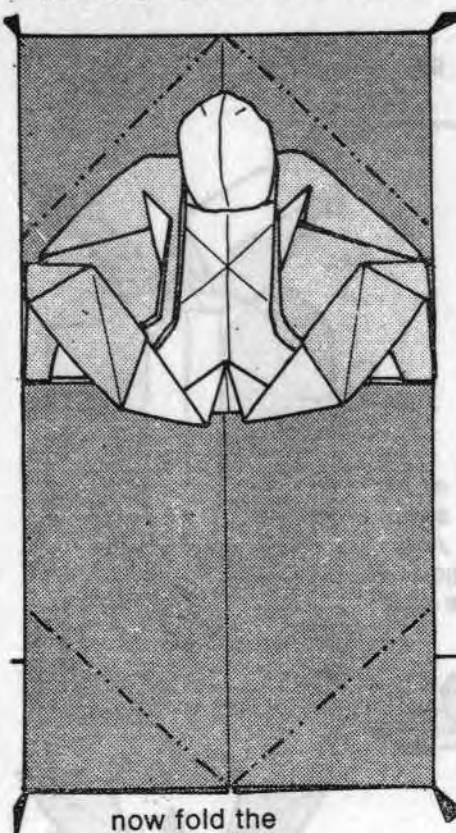

now fold the tortoise under Buddah see pages 104 and 105

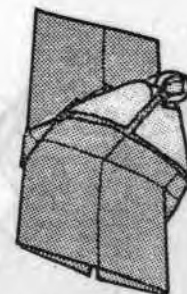

rear view of concave back

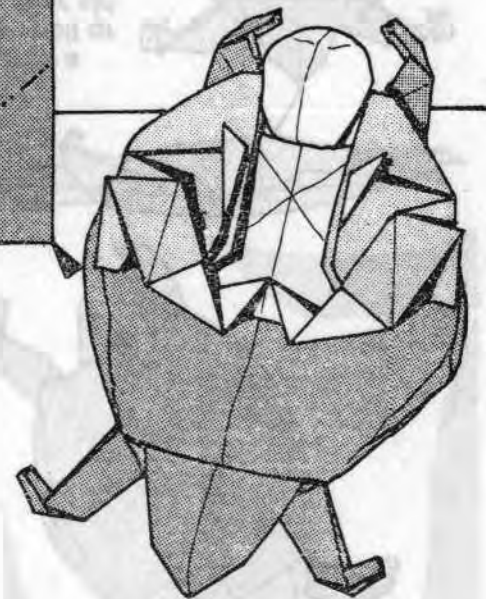

Buddah seated Neal Elias

U.S.A.

3 x 1 rectangle coloured as indicated on page 101
fold top portion into the Buddah and stop at fourth fold page 102

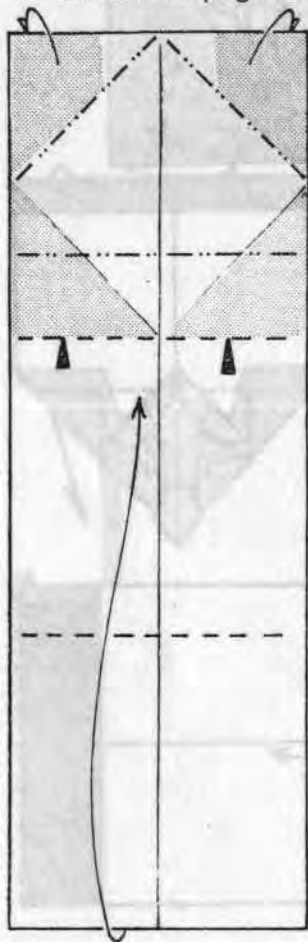

now fold the table under Buddah
(table by Fred Rohm)

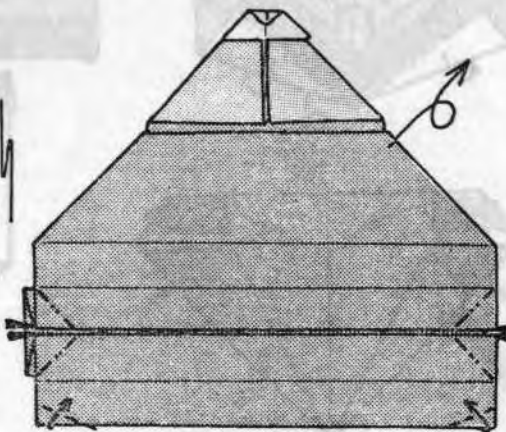

crease into eights then make a double crimp

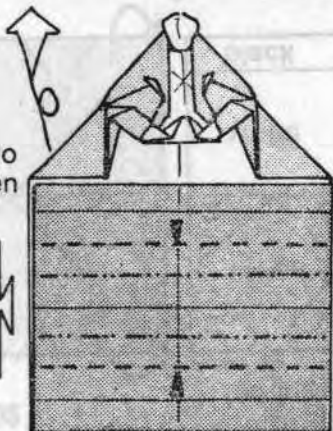

Buddah seated

A remarkable series

the sides fold down as X and Y go into the pockets all done at the same time

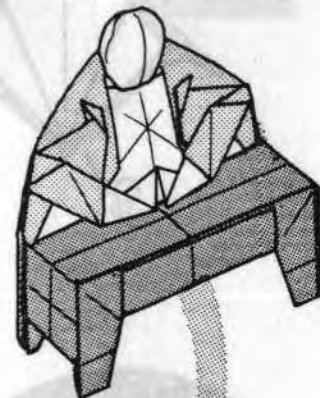
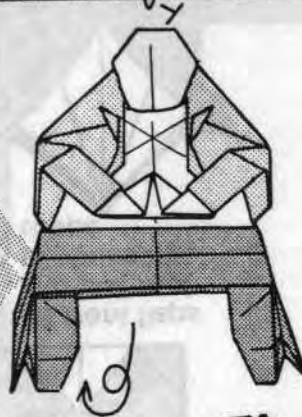
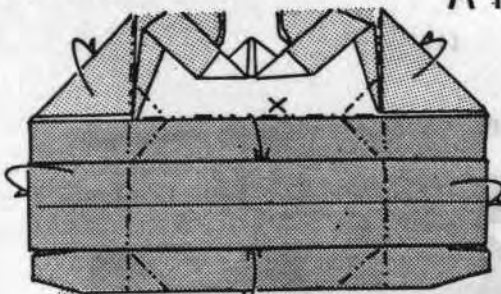

lift long flaps and fold each leg as for X

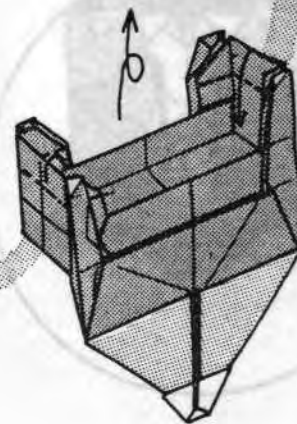
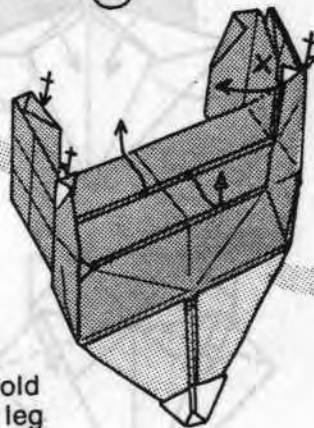

Shrine of Buddah Neal Elias

U.S.A.

begin with a 2 x 1 rectangle
coloured as indicated and using
red foil. Then fold as for
Buddah page 101 to fold 3 page 102

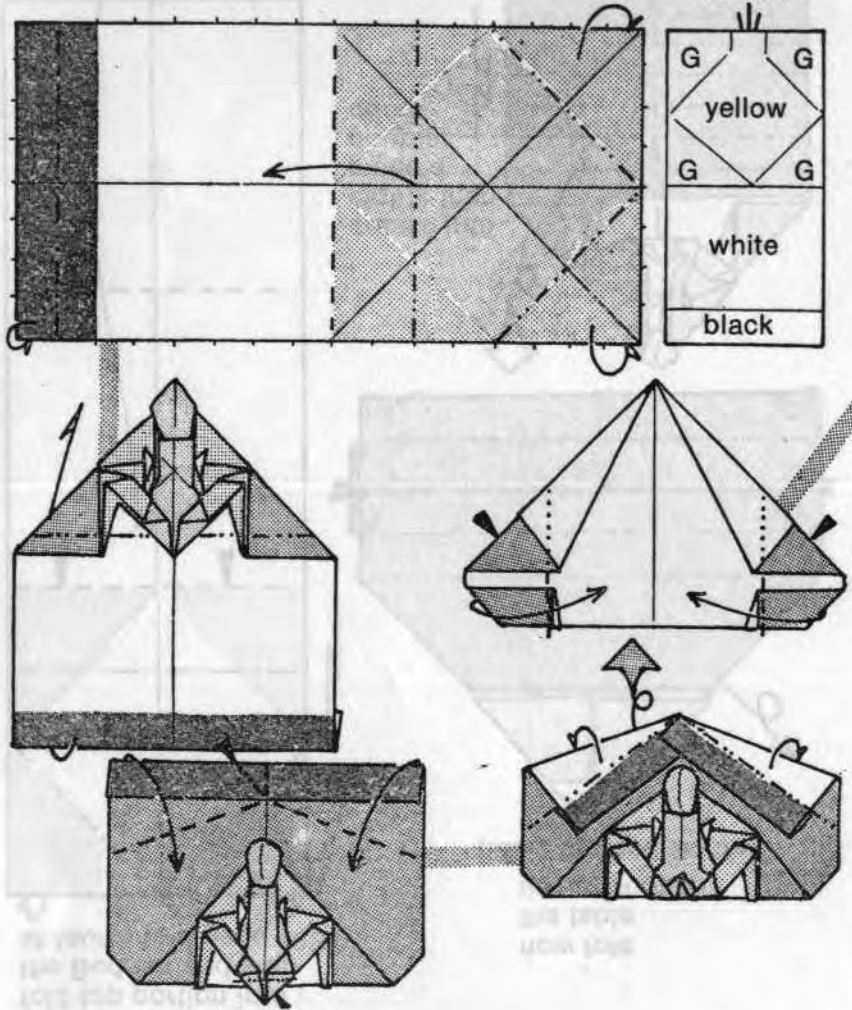

Shrine of Buddah concluded

Just great

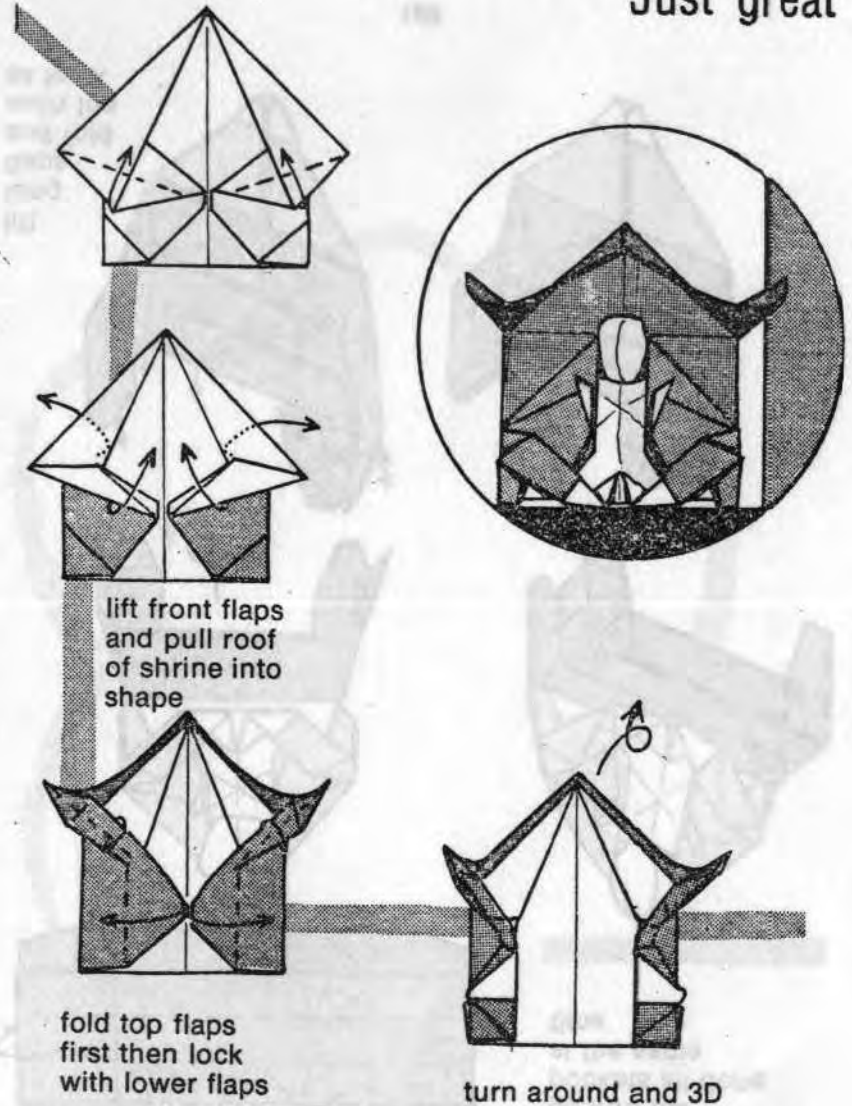

Viking Longship Laurie Bisman New Zealand

use a 4 × 1 rectangle
of foil crease down
the middle and valley
fold long flaps

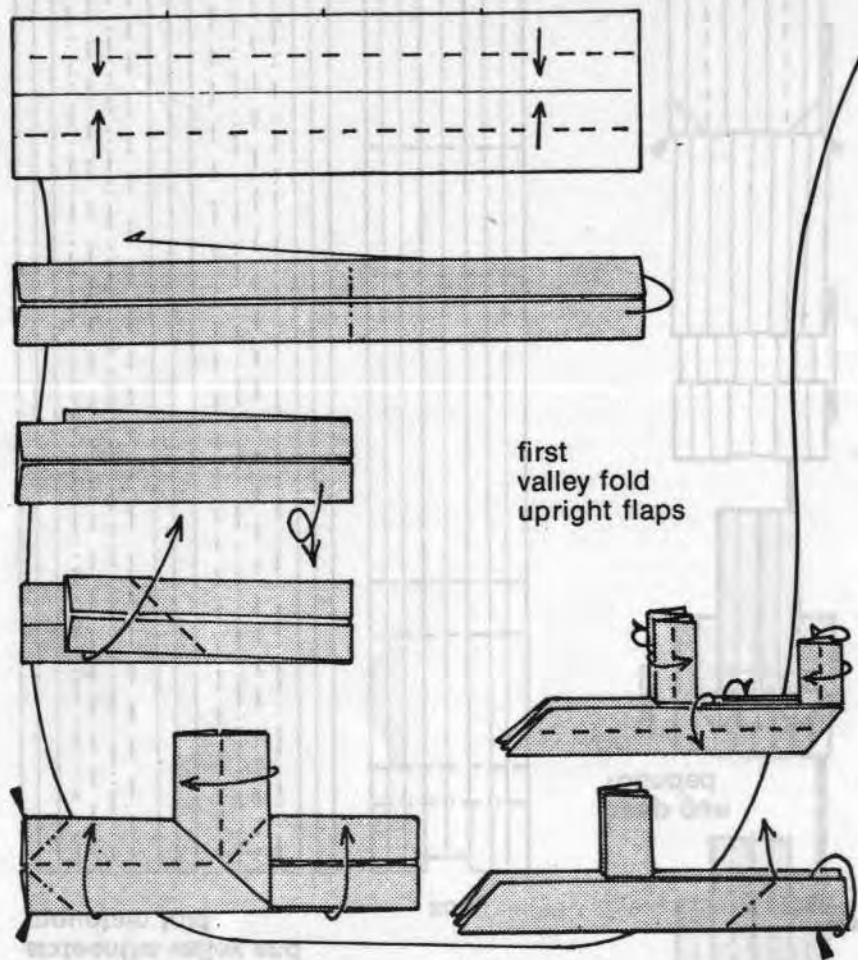

Viking Longship concluded

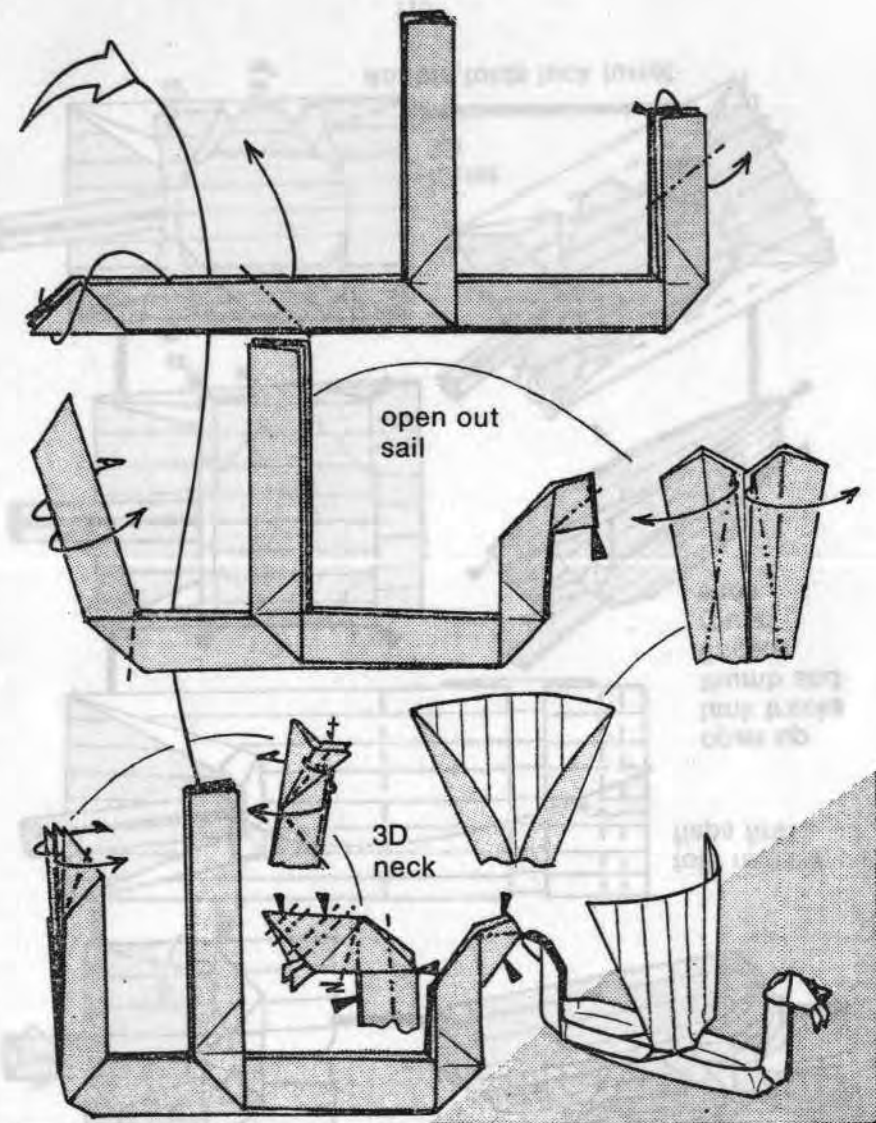

Tank Laurie Bisman

3 × 1 rectangle of foil creased as shown into sixteenths valley and mountain fold

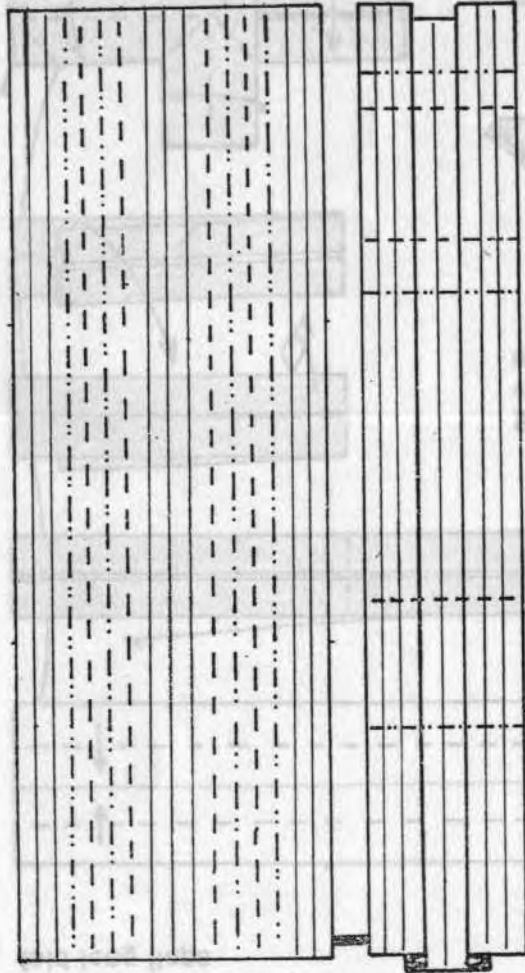

50

New Zealand

keep gun rounded

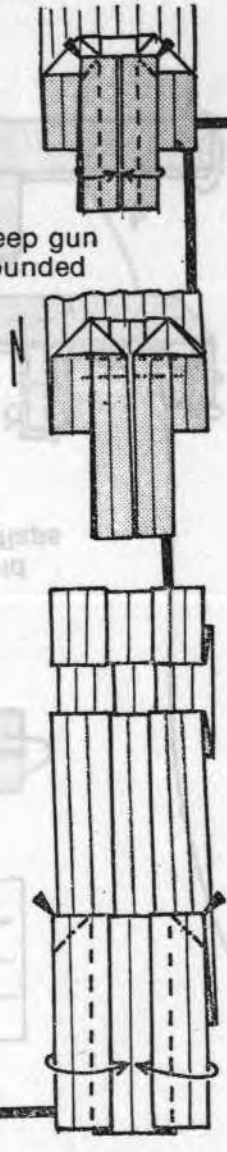

114

Tank

Ingenious

Gun elevates

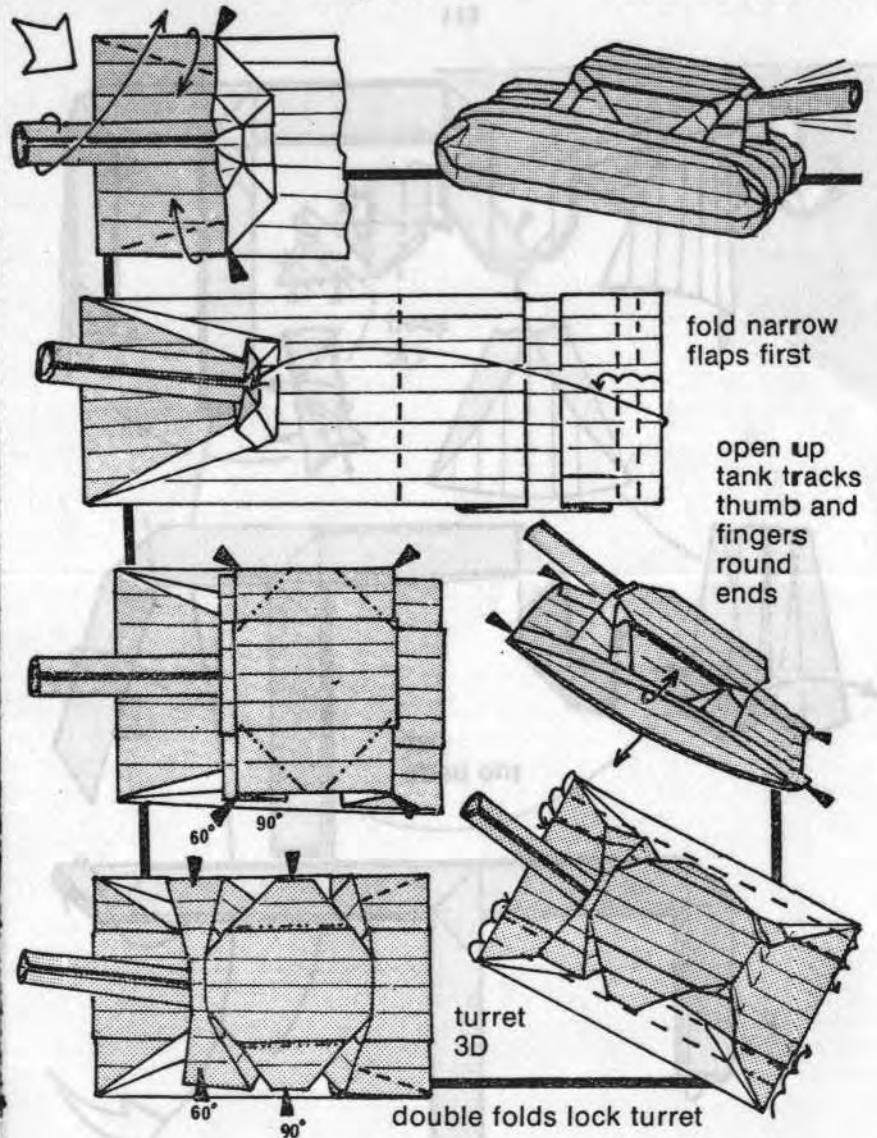

fold narrow flaps first

open up tank tracks thumb and fingers round ends

turret 3D

double folds lock turret

115

Palm Tree Max Hulme

Gt. Britain

use a square
brown or green
one side

petal fold the
small flap as
you valley fold
the long flaps

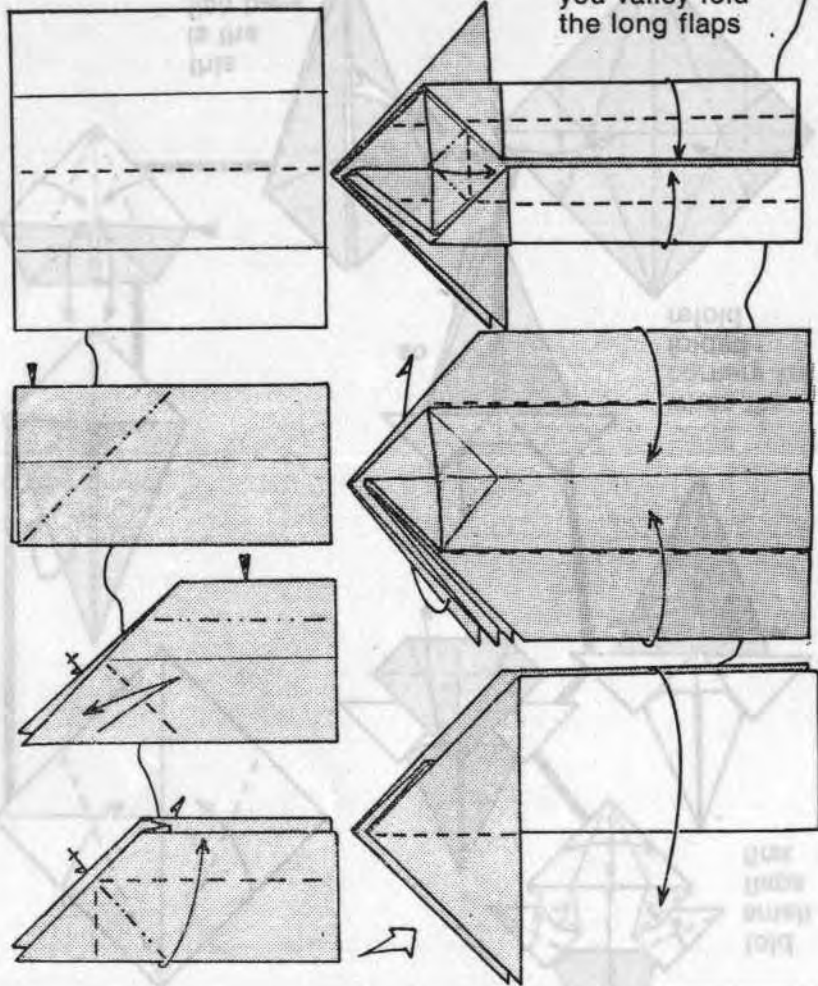

Palm Tree concluded

Make your own Island

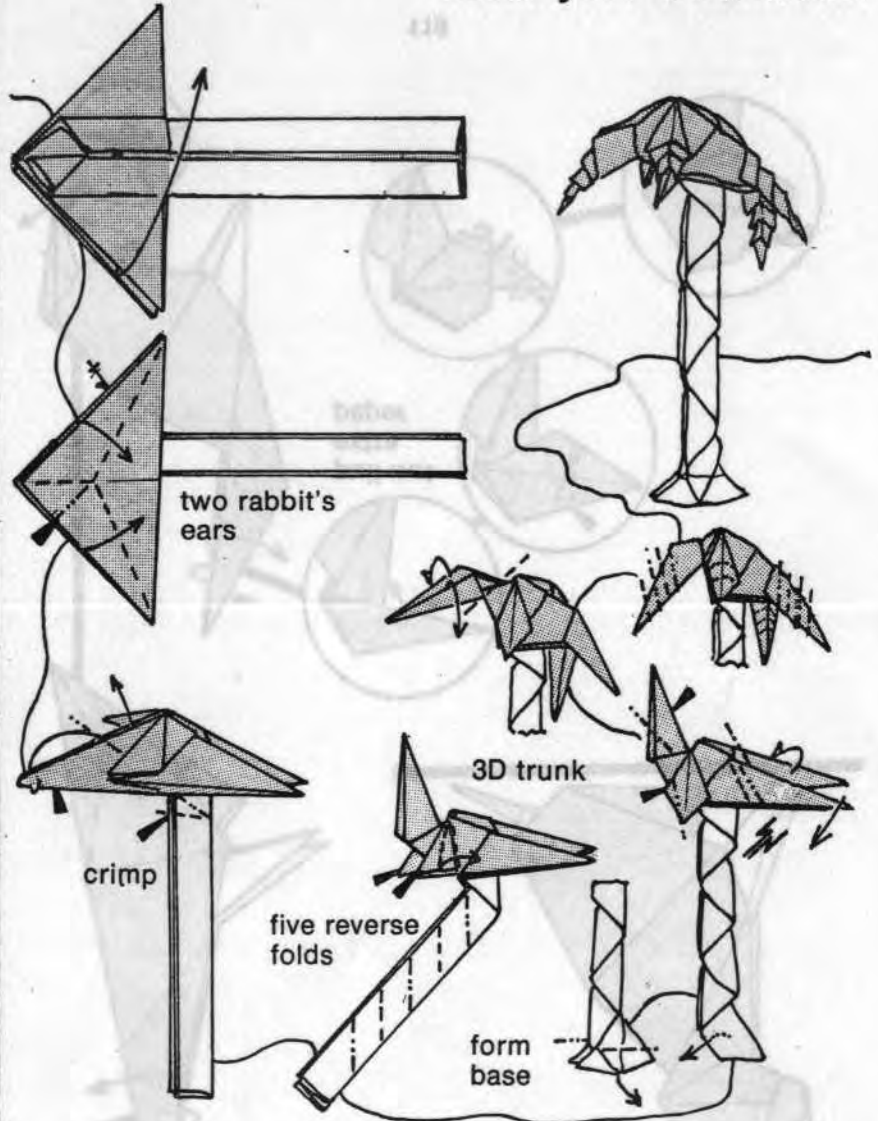

Good Dog Malcolm Kerr

Gt. Britain

a square brown one side. Crease then start

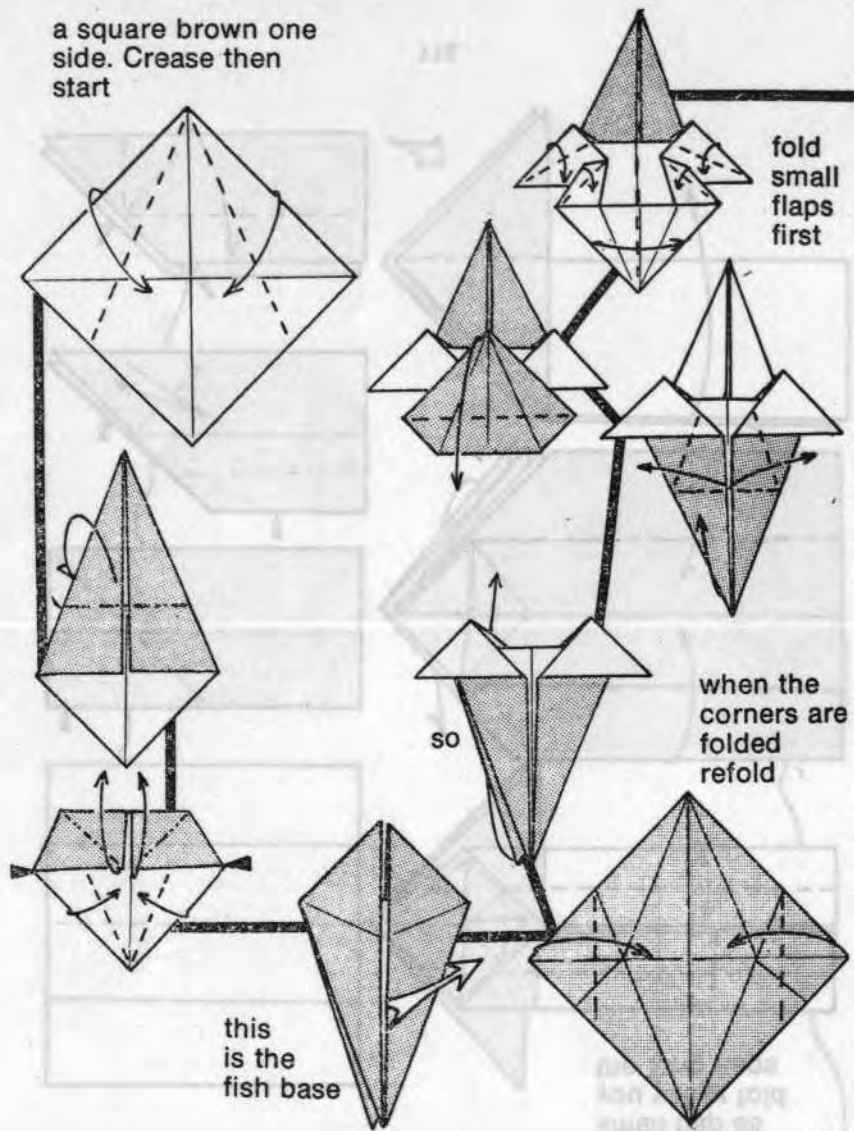

Good Dog

Fine model by a young folder

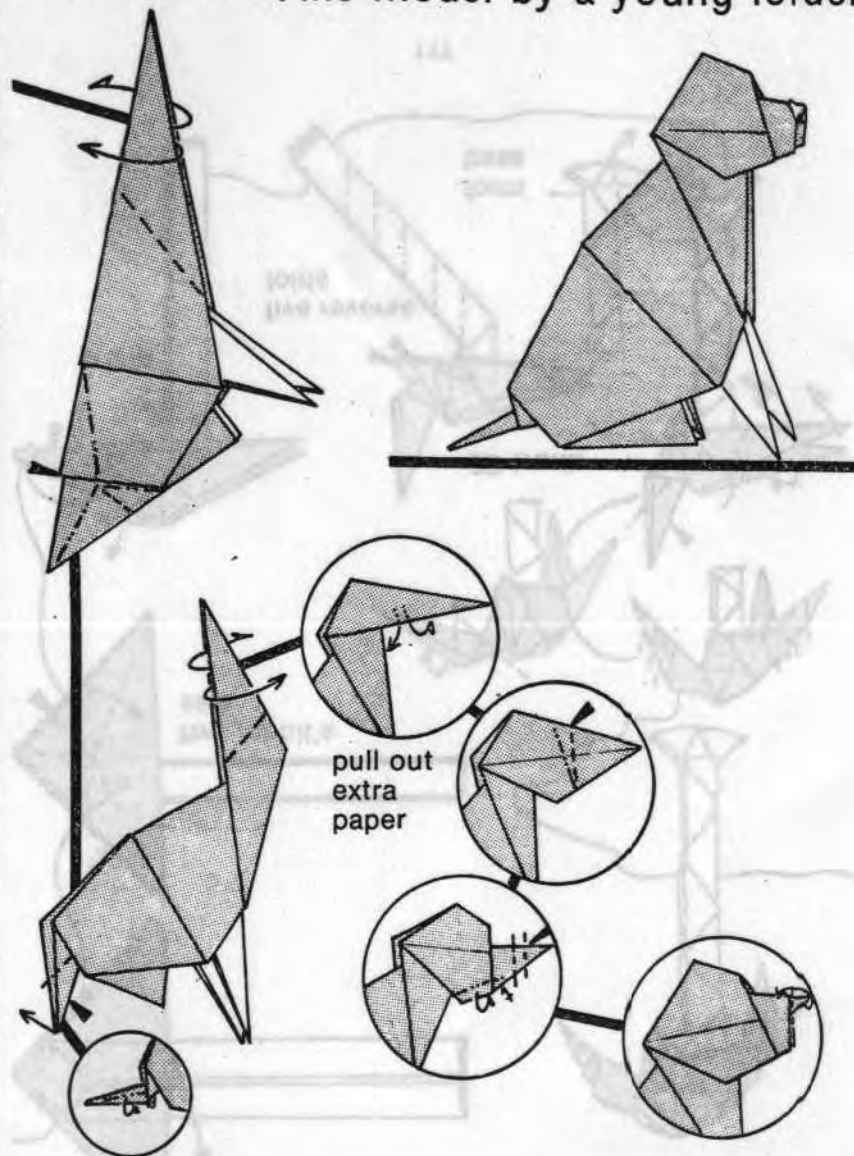

Tri-star Lewis Simon

use a square make guide
creases fold over and over
two sides as indicated
(thirds) and unfold
once

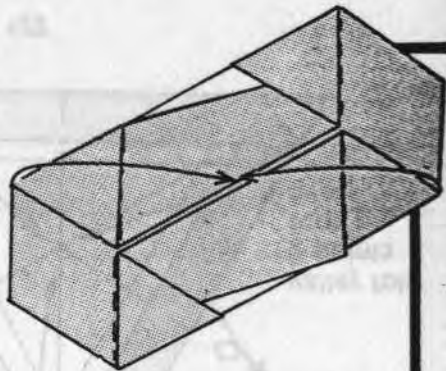
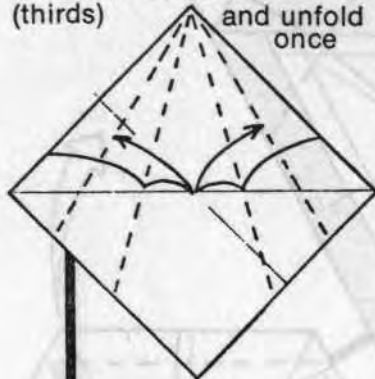

so

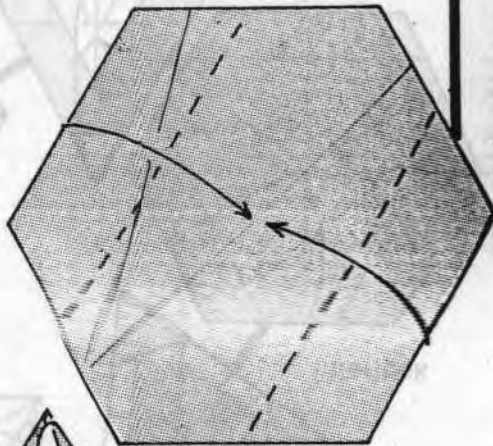
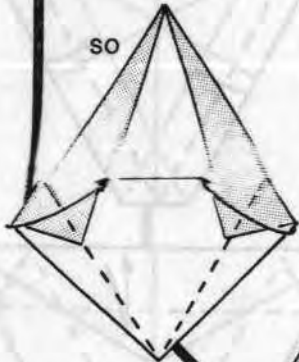

valley fold
points then
turn over

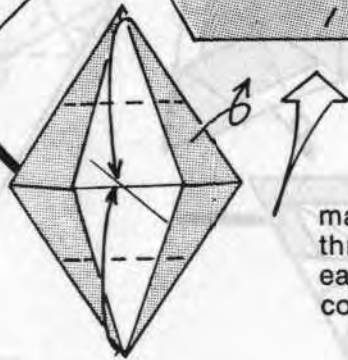

make
three of these
each a different
colour

120

U.S.A.

Tri-star concluded

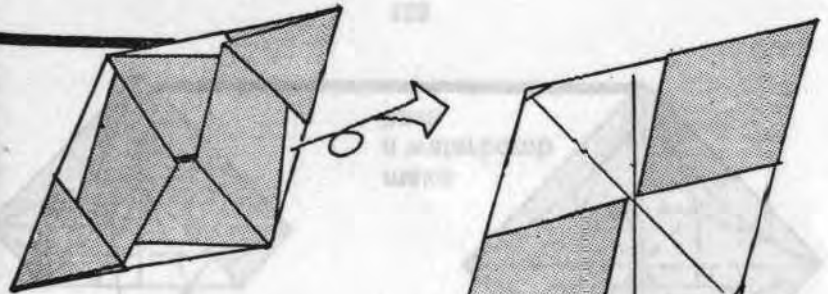

two
together

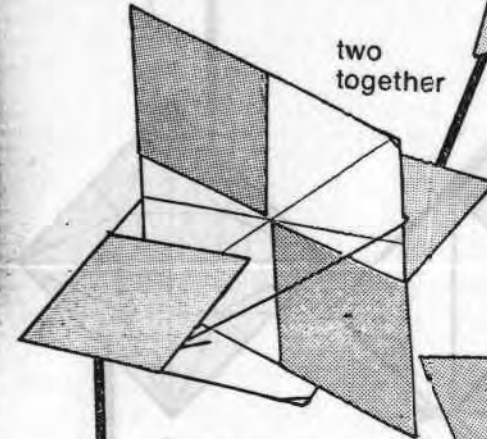

add one
more

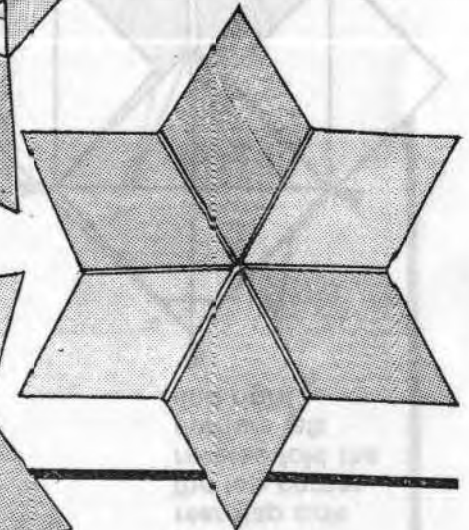
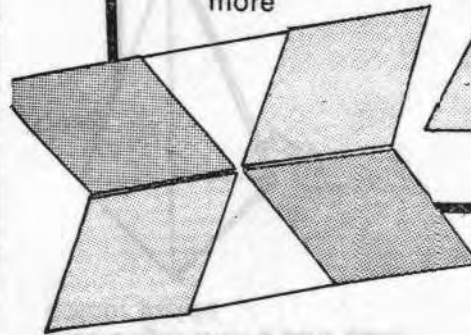

121

Diamond Lewis Simon

U.S.A.

use an equilateral triangle make creases

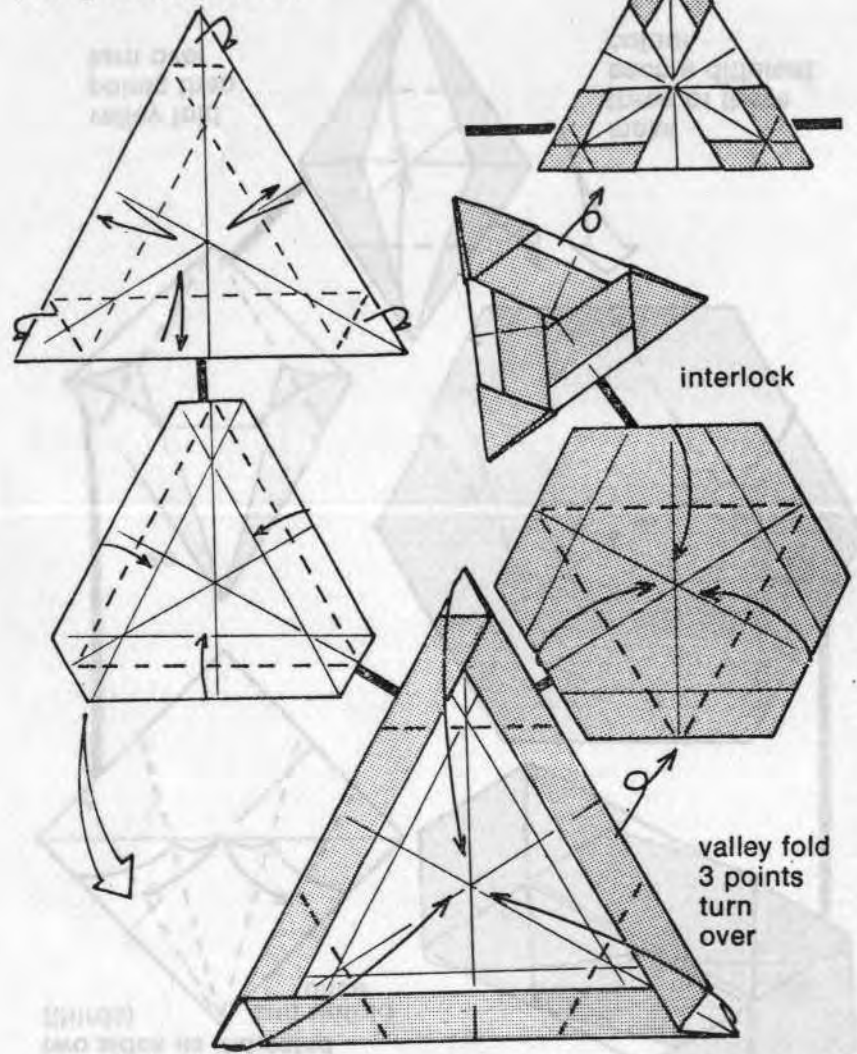

Oberon Neal Elias

U.S.A.

use a square green one side begin with a bird base colour inside

petal fold the rear flap sink the top corner reverse fold the corners left and right

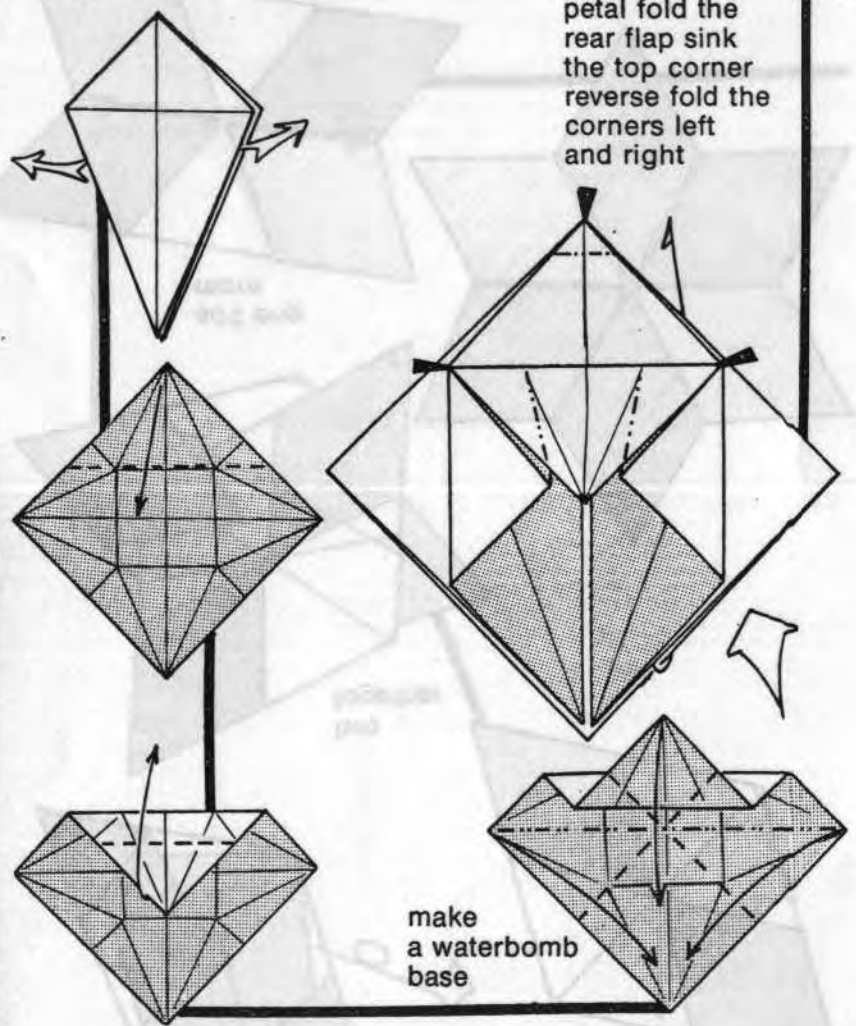

Oberon continued

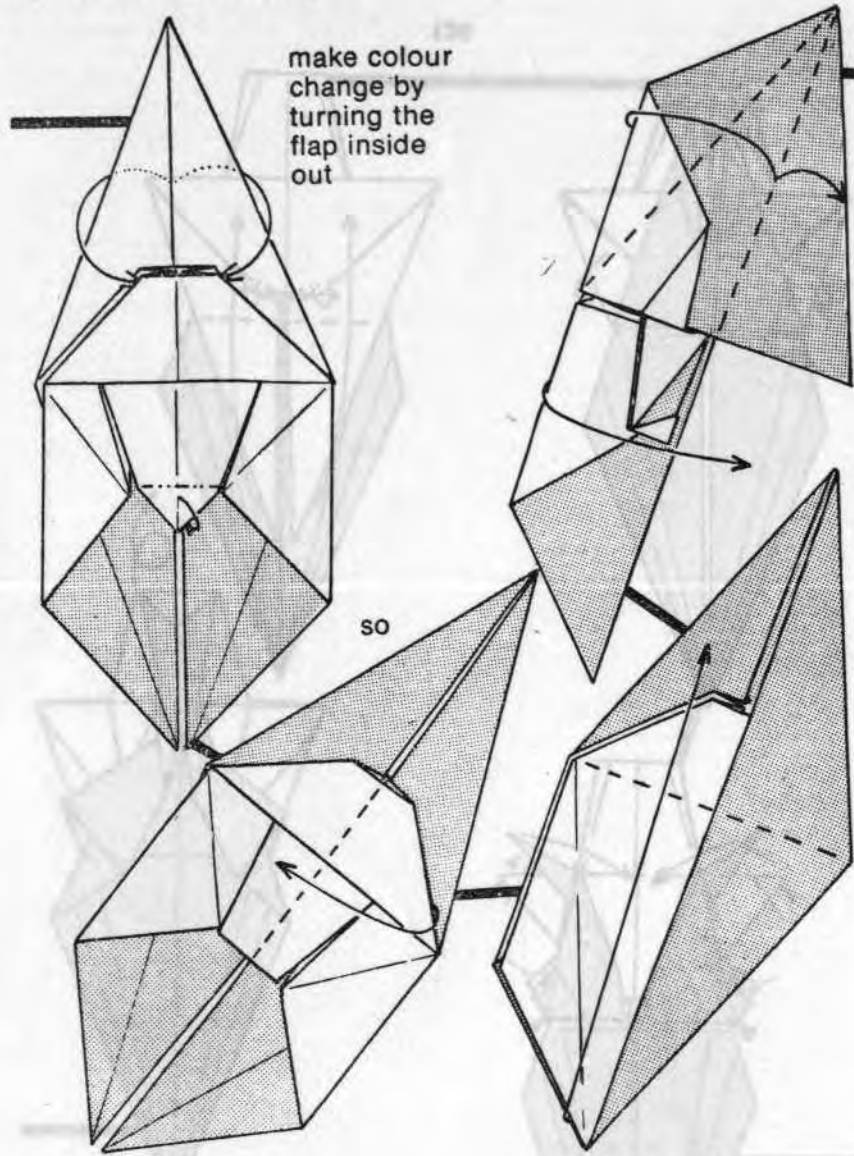

Oberon continued

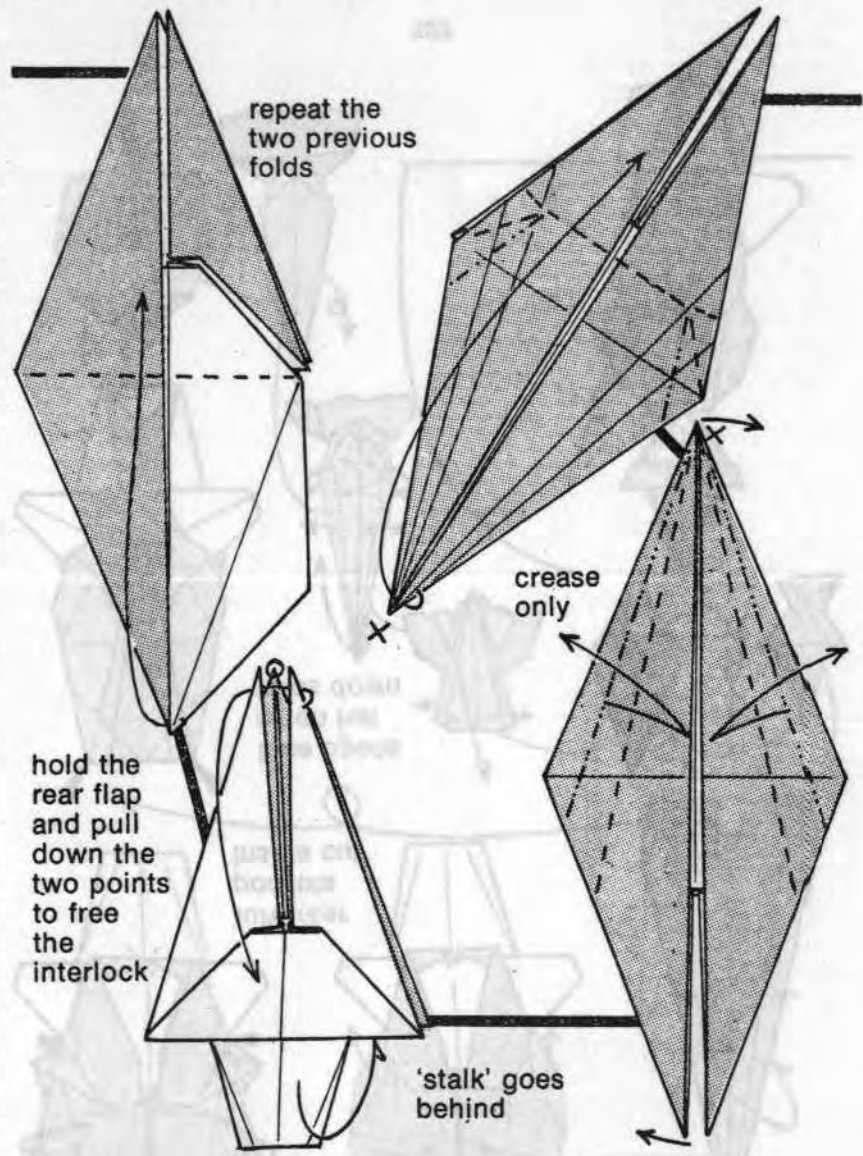

Oberon continued

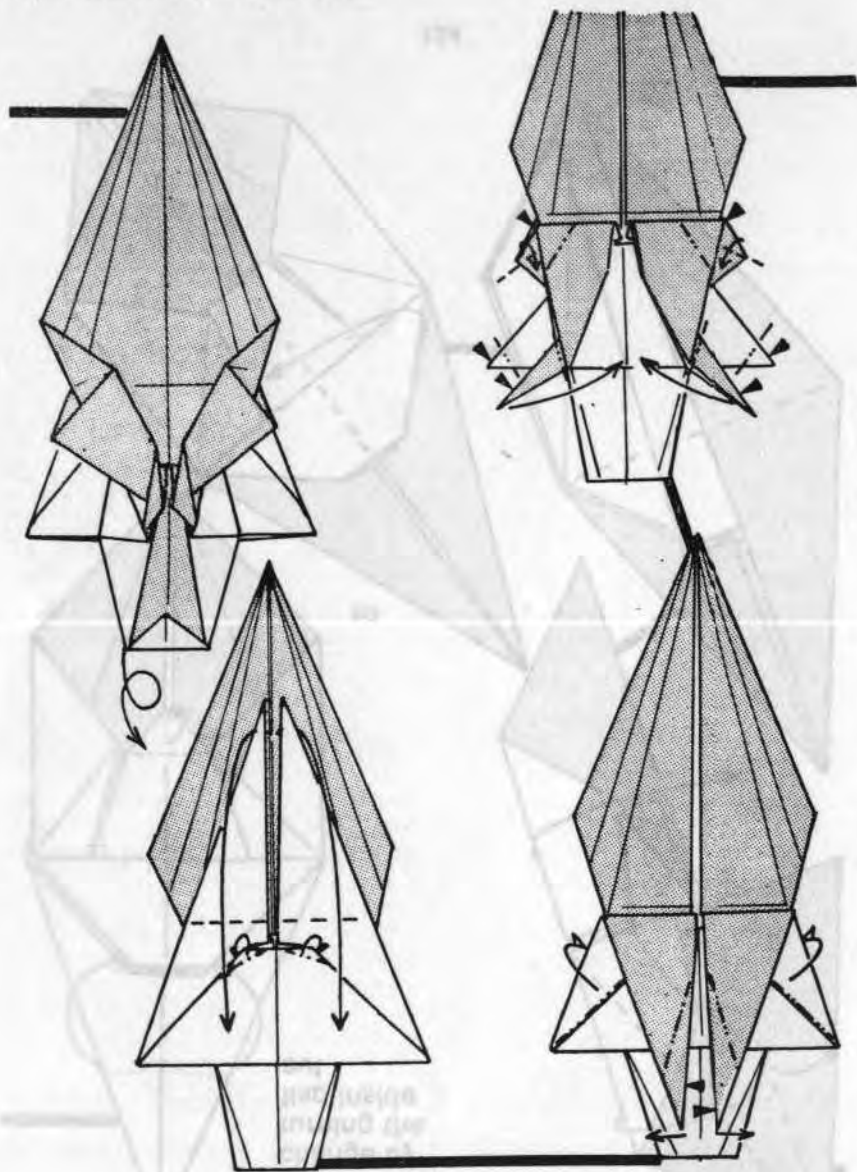

Oberon concluded

Another great fold

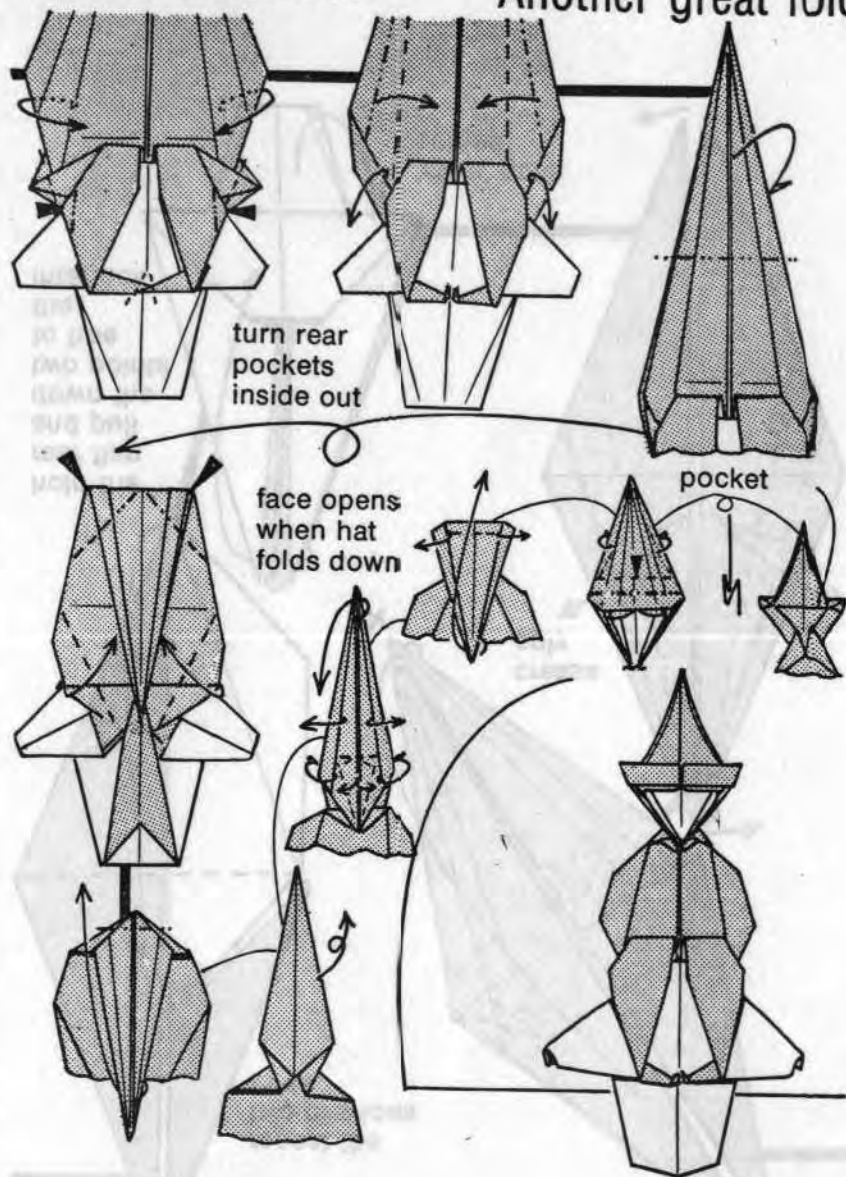

Dancers Neal Elias

U.S.A.

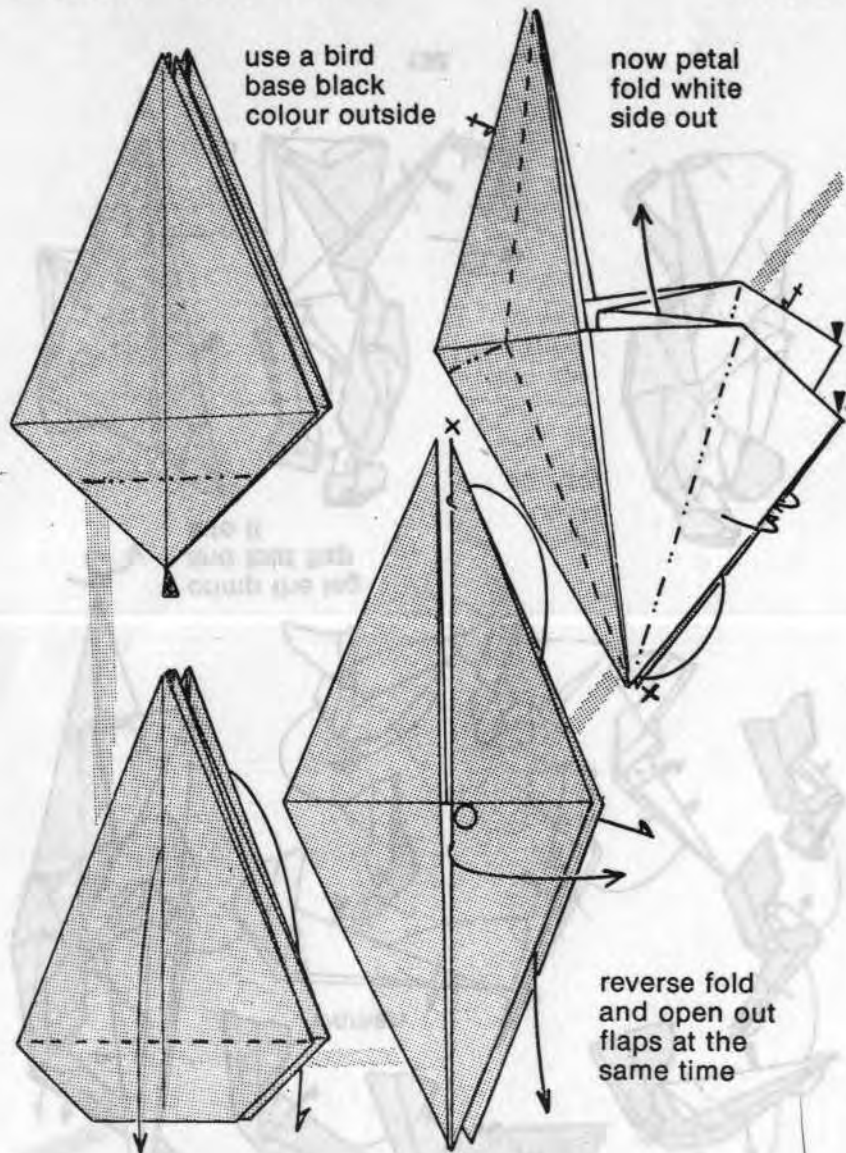

use a bird
base black
colour outside

now petal
fold white
side out

reverse fold
and open out
flaps at the
same time

Dancers

Don't miss a sign or symbol

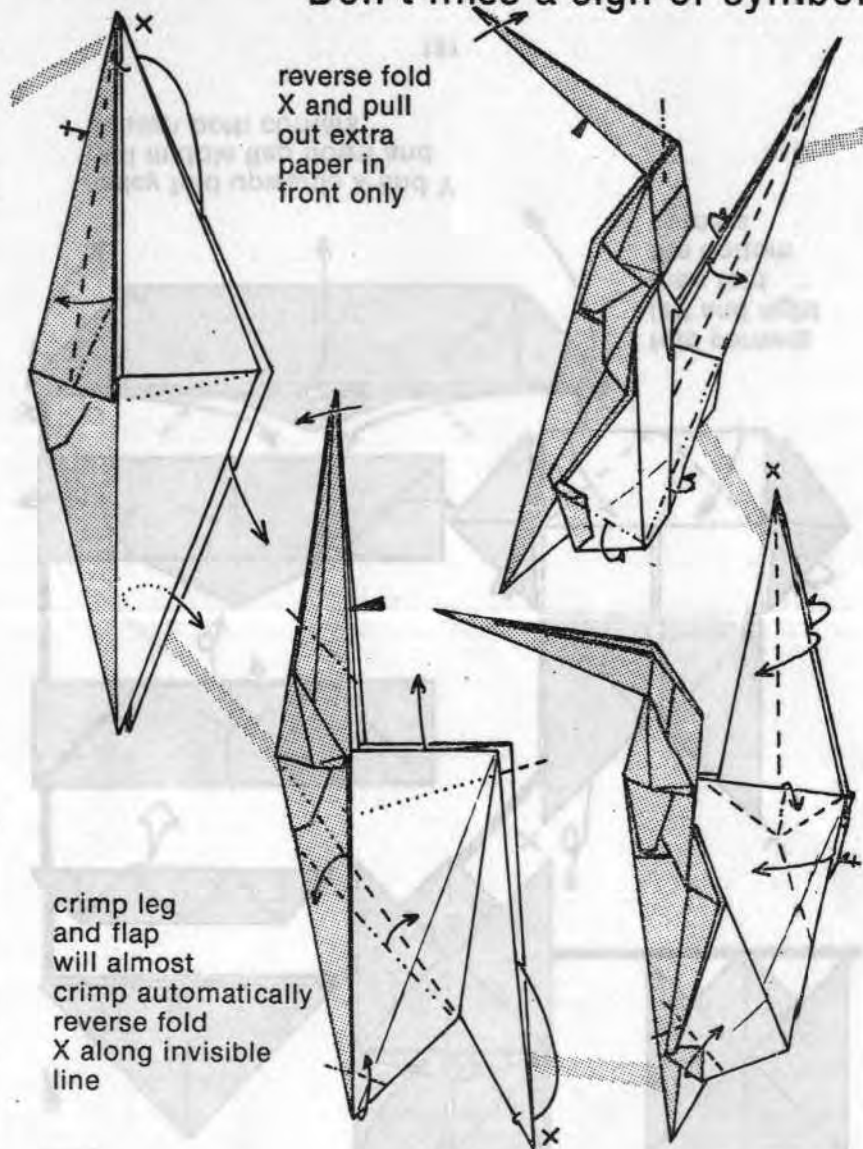

reverse fold
X and pull
out extra
paper in
front only

crimp leg
and flap
will almost
crimp automatically
reverse fold
X along invisible
line

Dancers concluded

My favourite fold

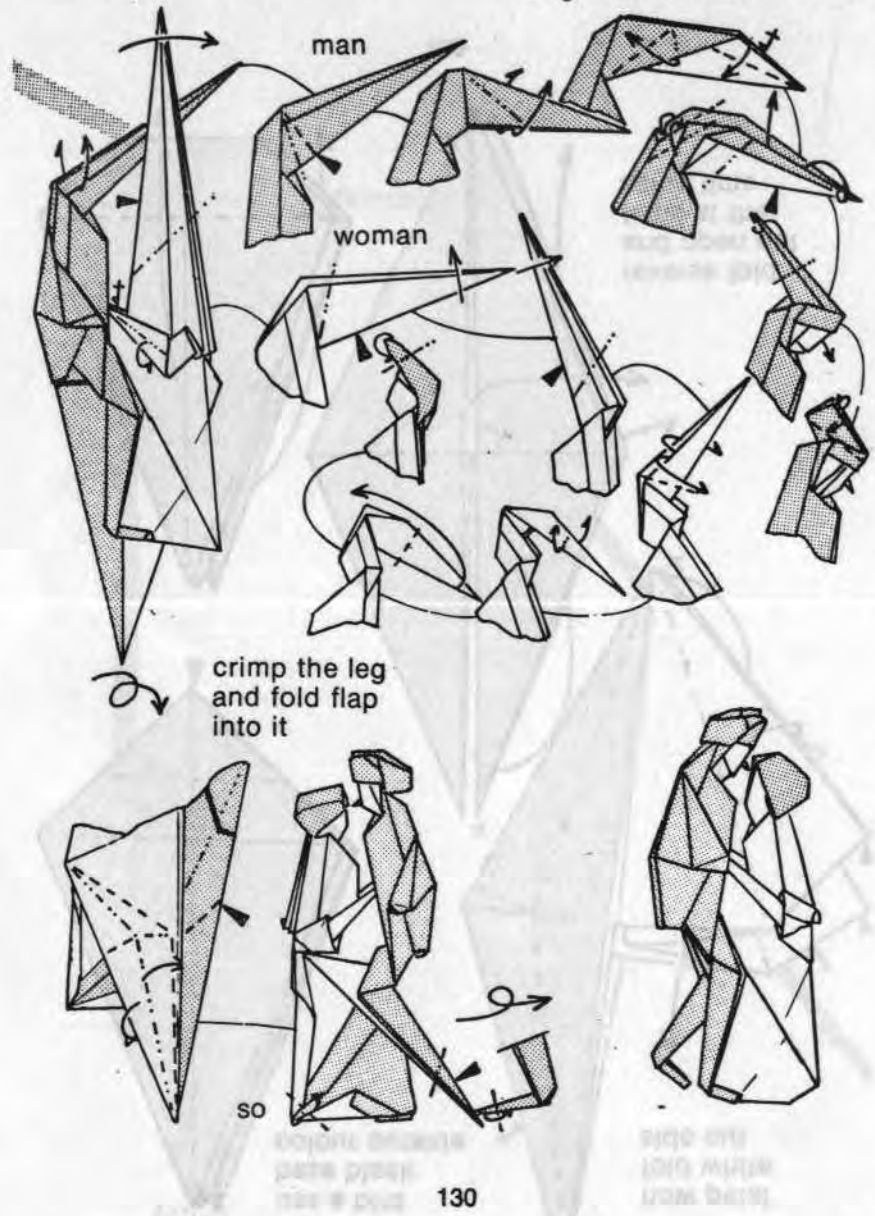

Square Owl Eric Kenneway

Gt. Britain

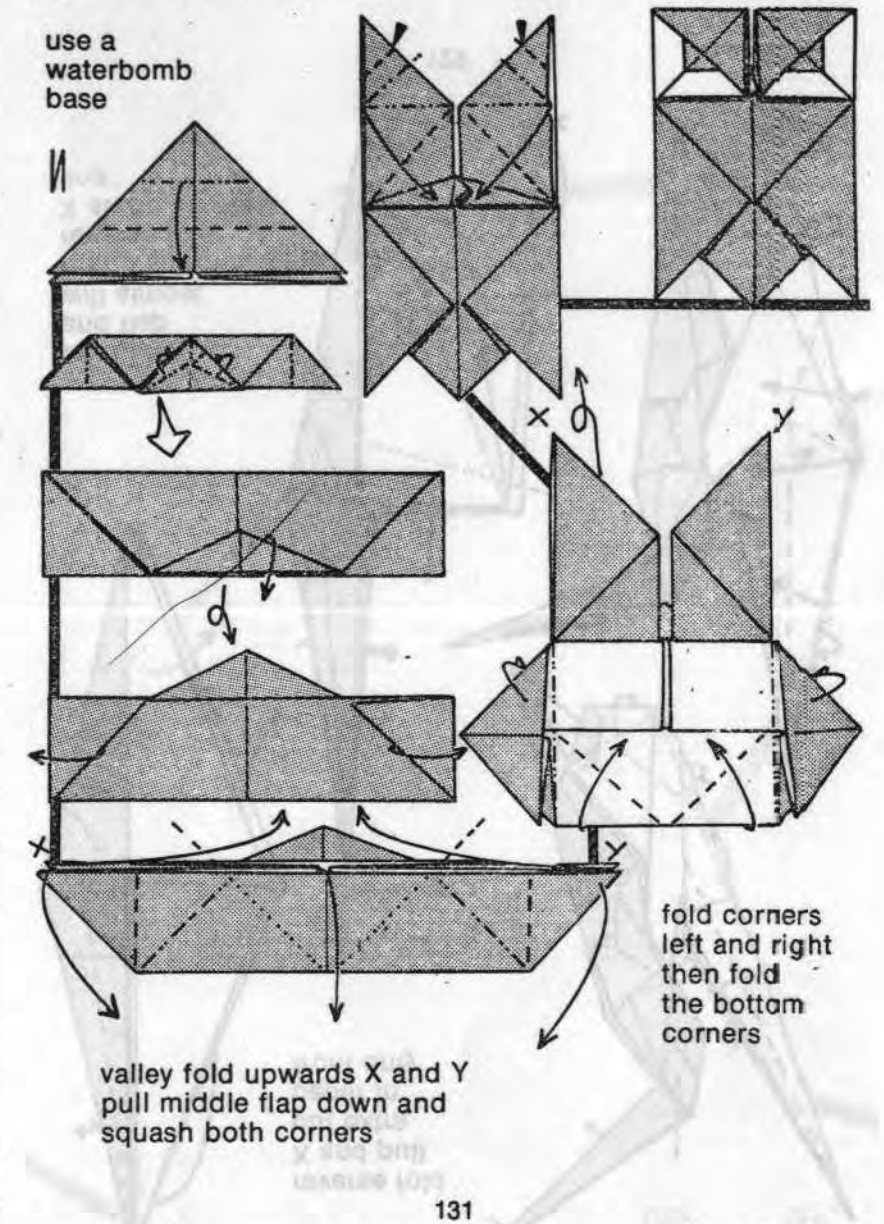

Chick Hatching Neal Elias

U.S.A.

a square yellow
one side

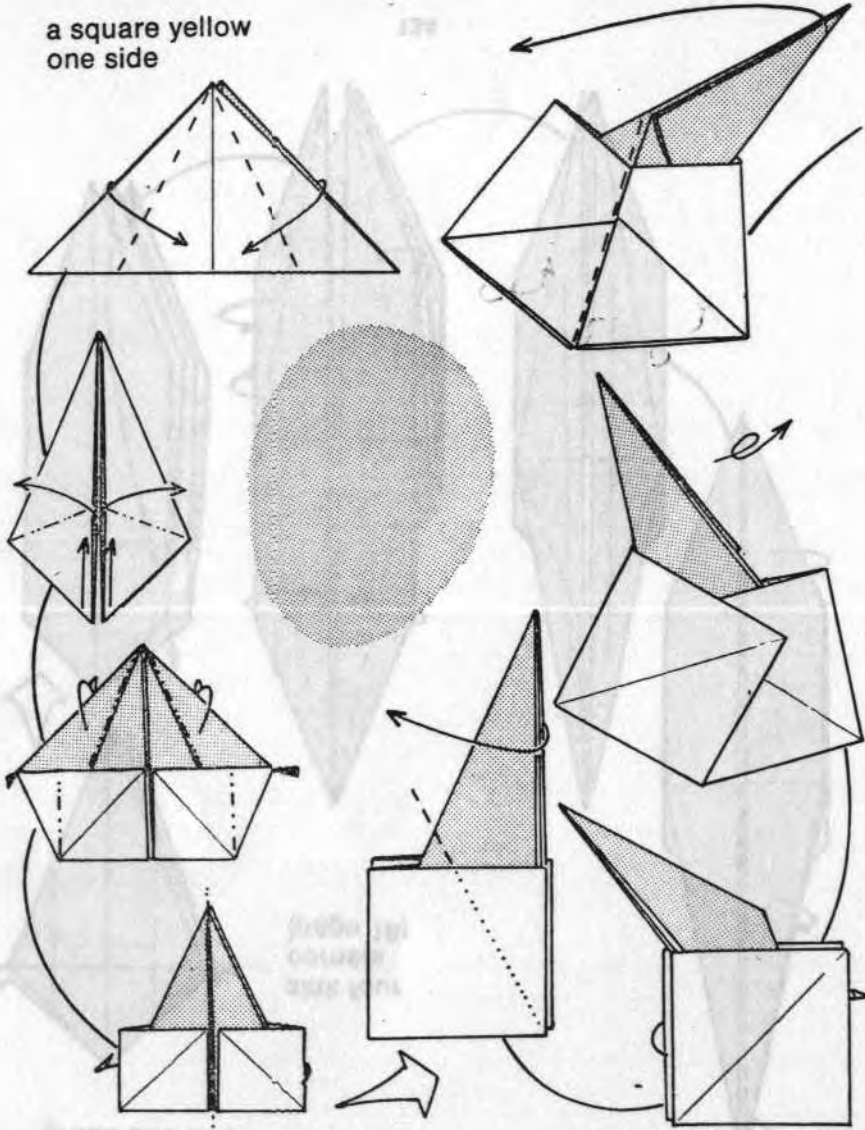

Chick Hatching

Surprise — Surprise

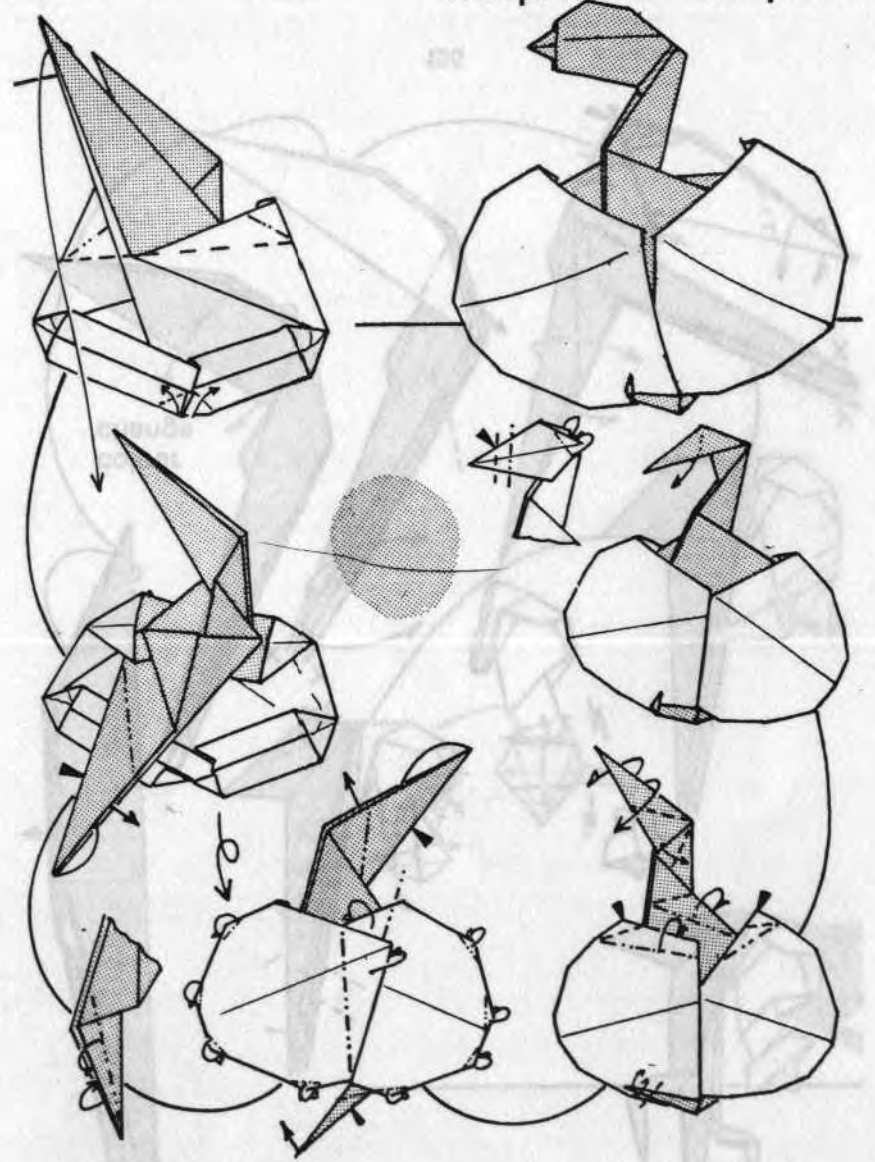

Siesta Neal Elias

U.S.A.

begin with a bird base
green one side

sink four
corners
(page 16)

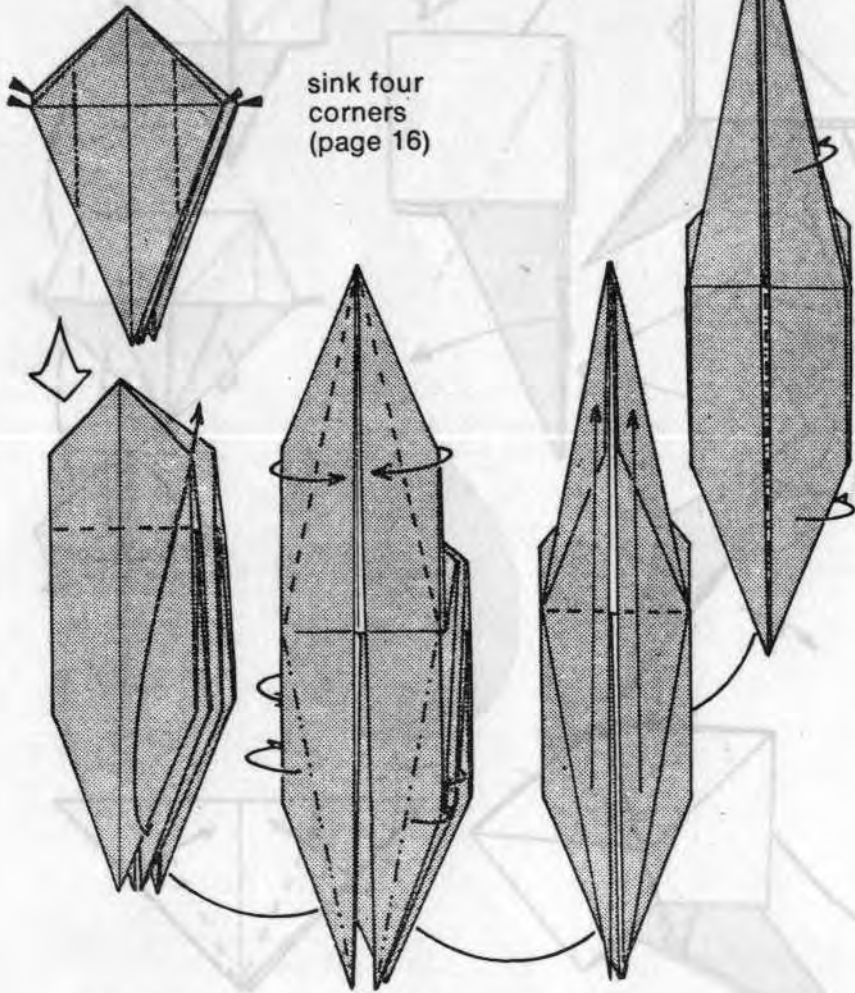

134

Siesta concluded

Hot

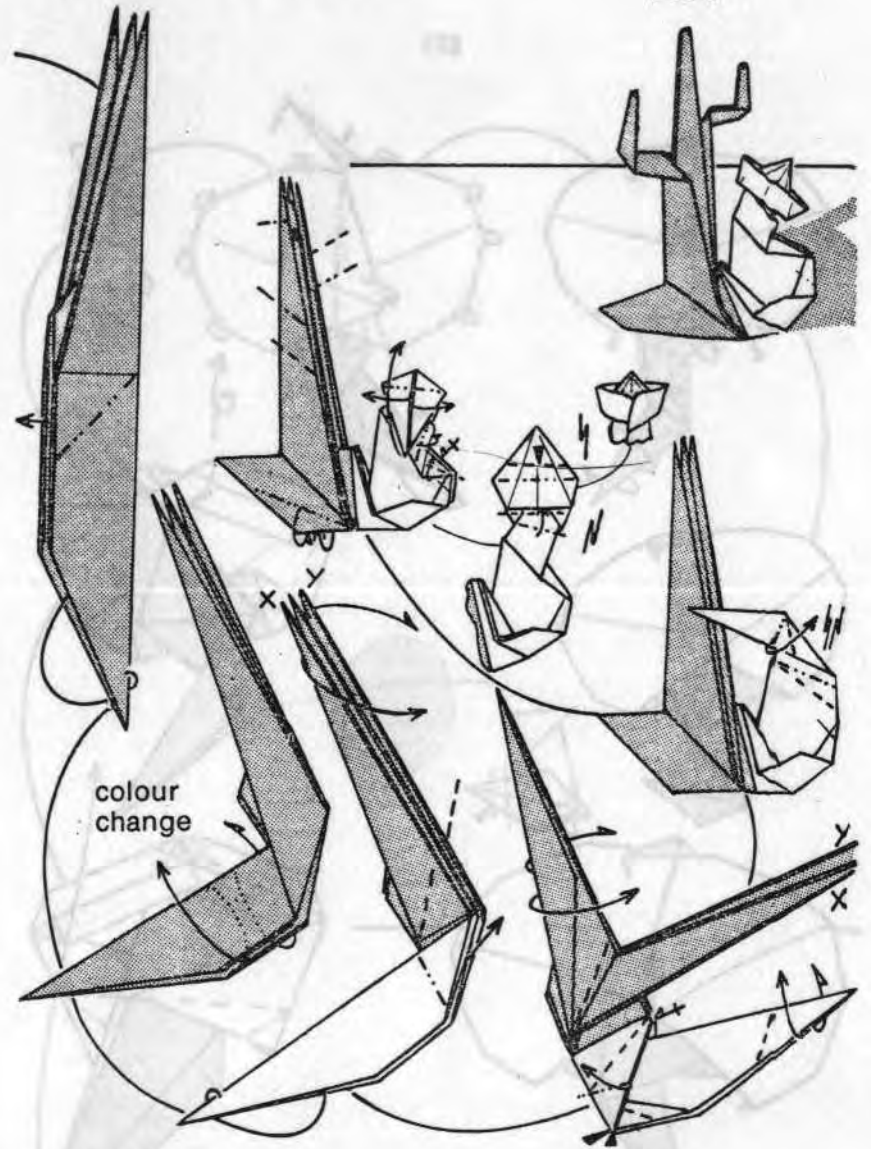

135

Decoration Iris Walker

Gt. Britain

pre-crease a square carefully. Lift corners 90° push sides in

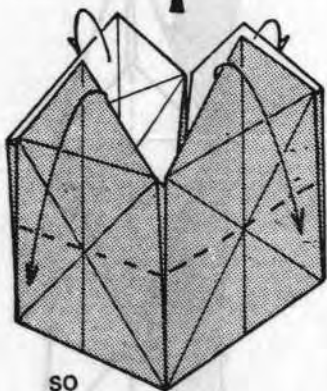
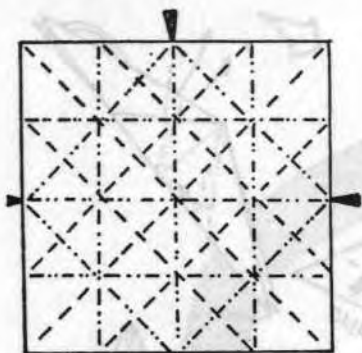

so

valley fold four sides and arrive at the result on the right. A bit of a struggle

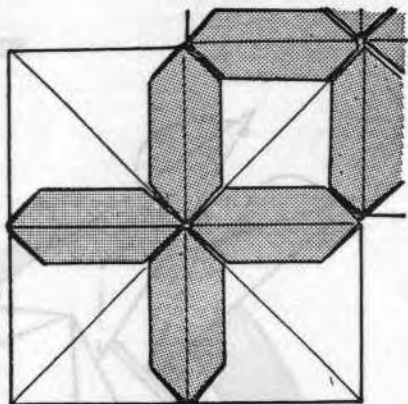

make several and fit together for fine display

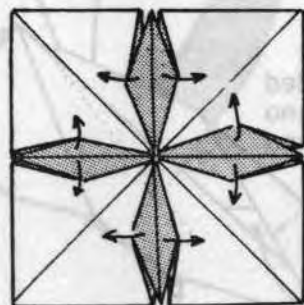
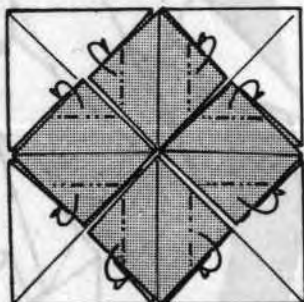

Persian Horse Dale Walton

U.S.A.

begin with a bird base

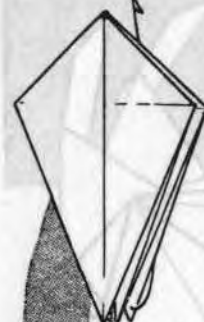

nearly all reverse folds

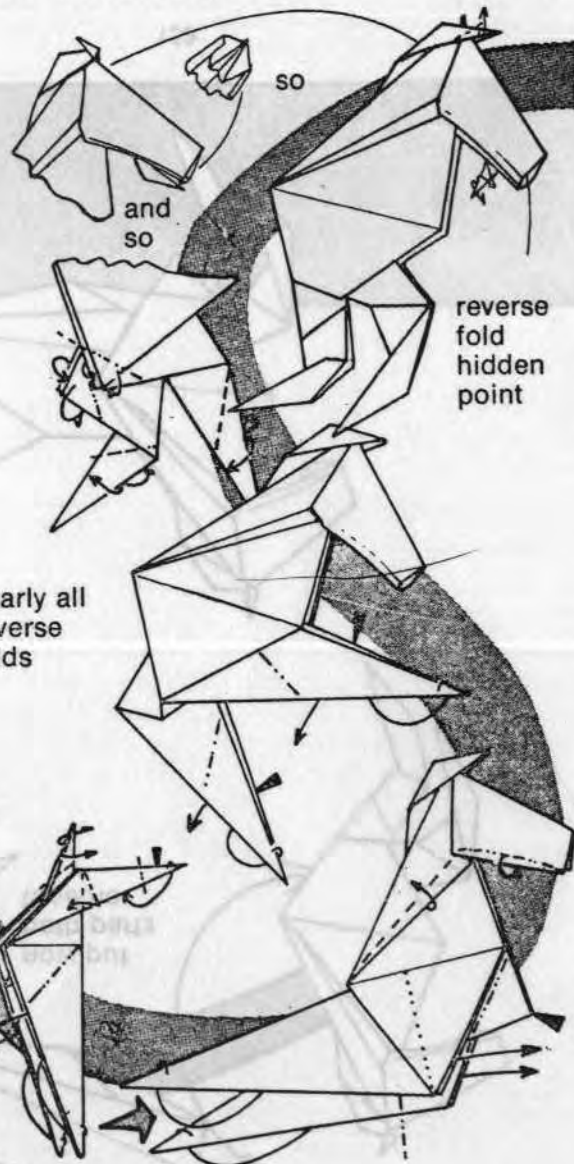

so

and so

reverse fold hidden point

Persian Horse continued

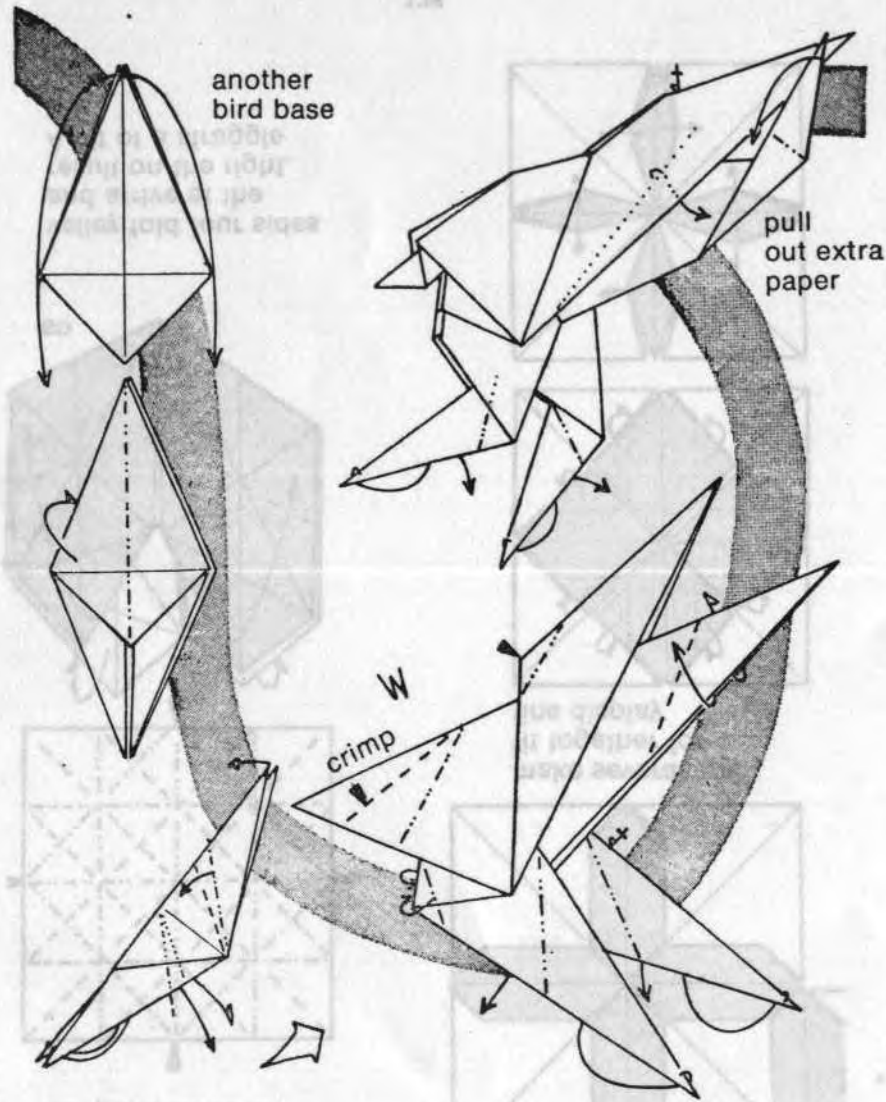

138

Persian Horse concluded

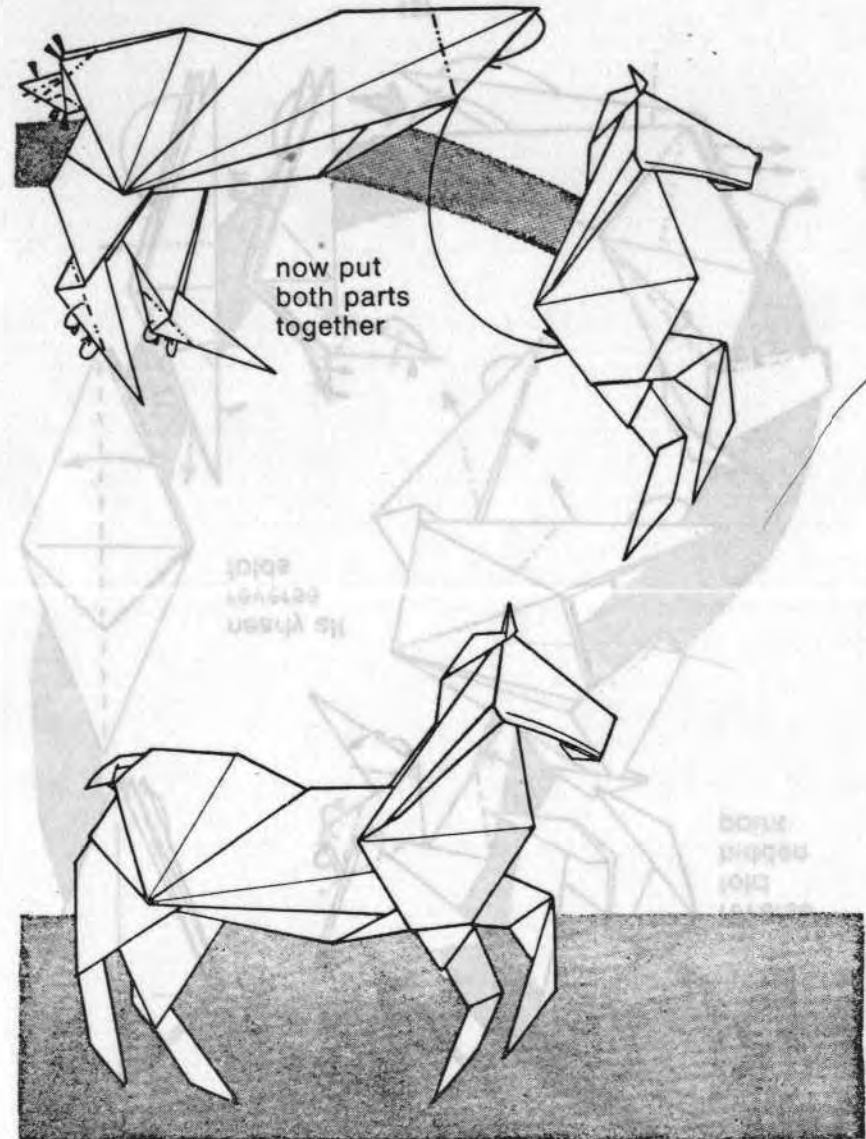

139

Lion Reclining Philip Yoshio Kushi U.S.A.

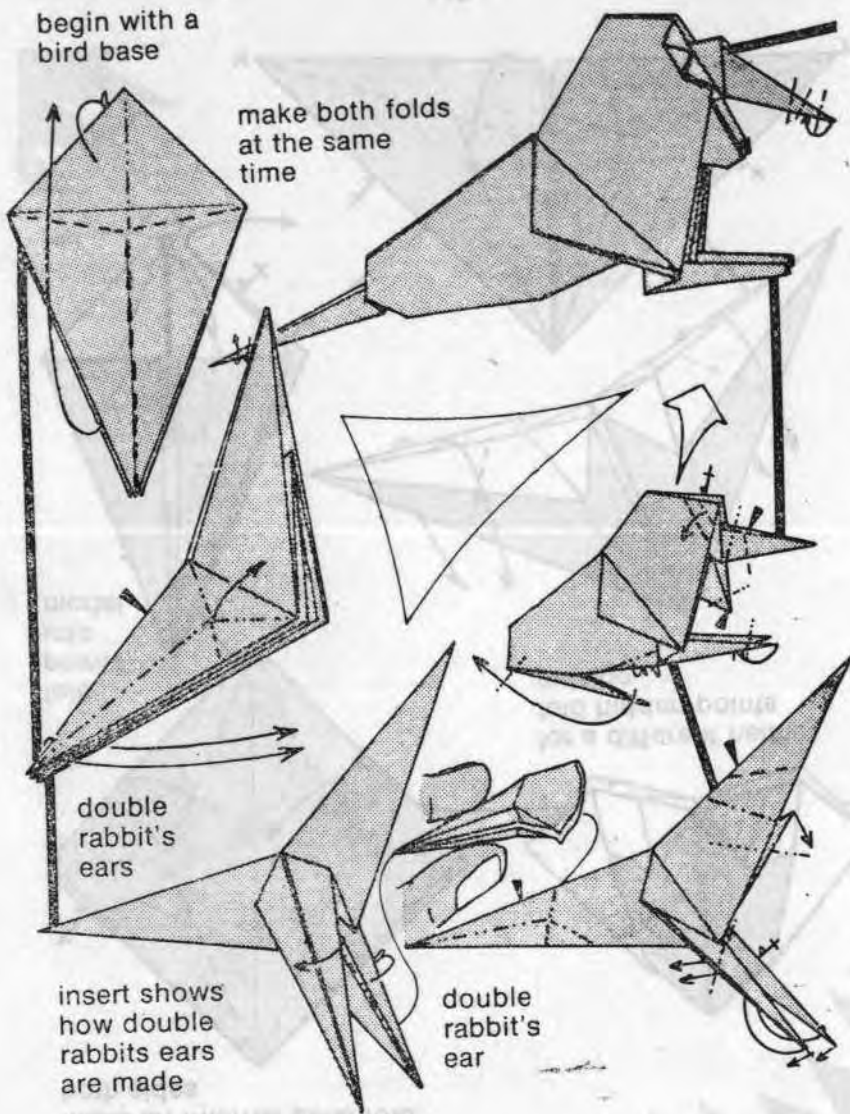

Lion Reclining concluded

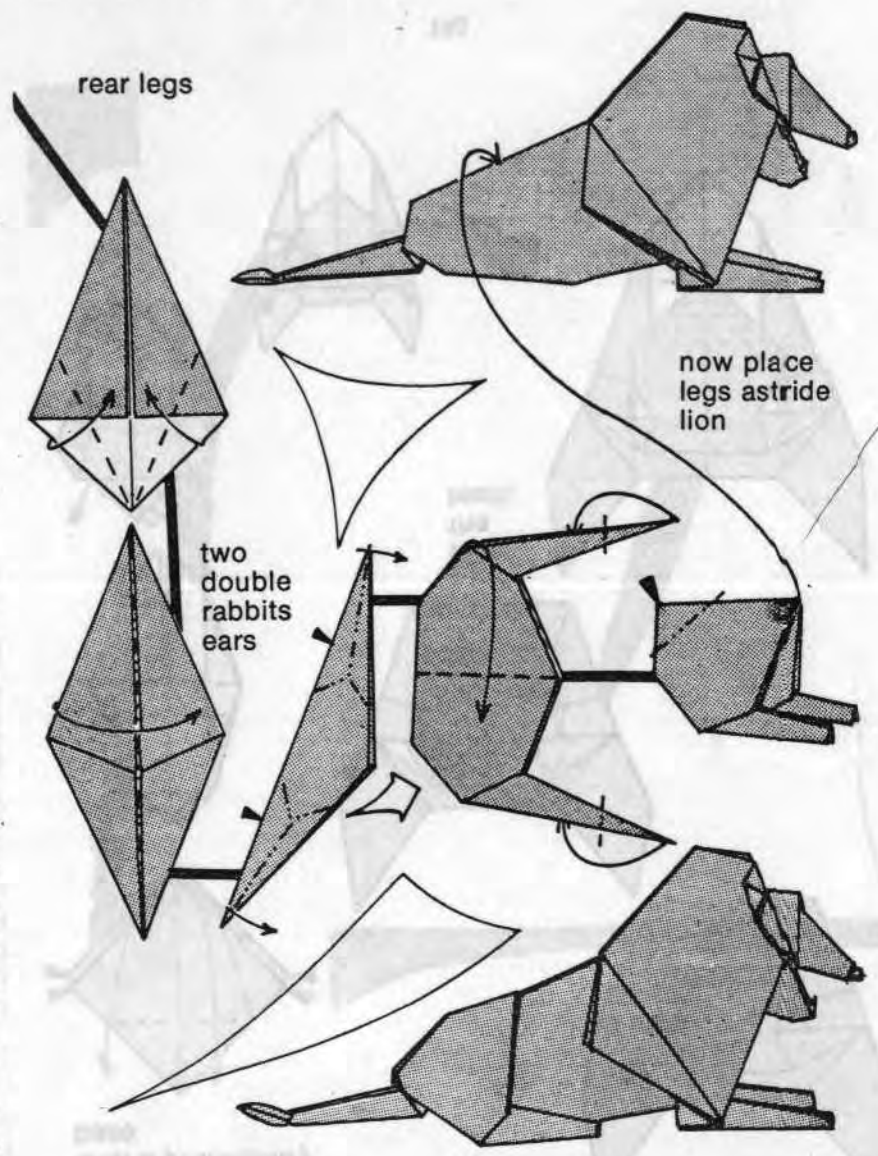

Helmet Robert Harbin

Gt. Britain

begin with a preliminary
base colour in or out.
Make an internal petal fold
both sides

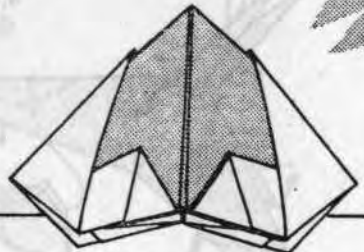
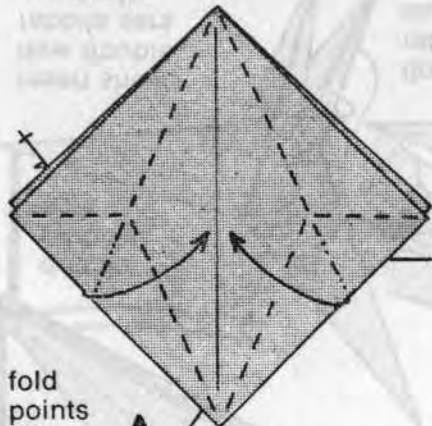

for a different helmet
fold hidden points
outside

fold
points
into
model

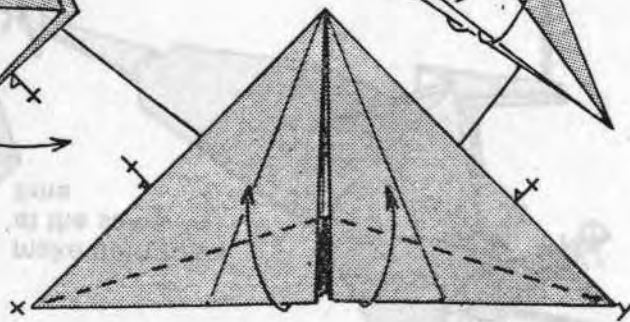
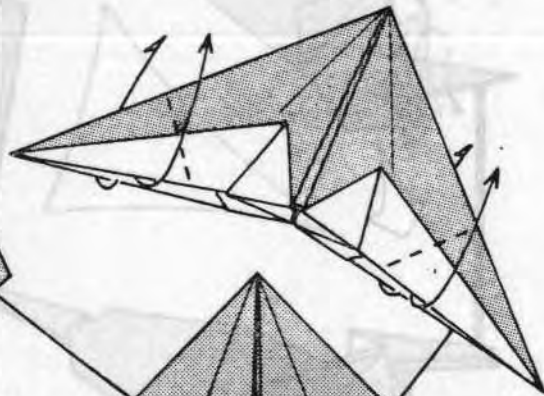
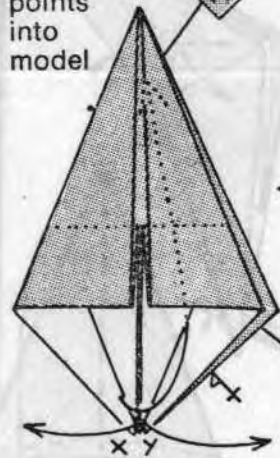

Hell Cat Robert Harbin

Gt. Britain

use a square begin
with a preliminary
base

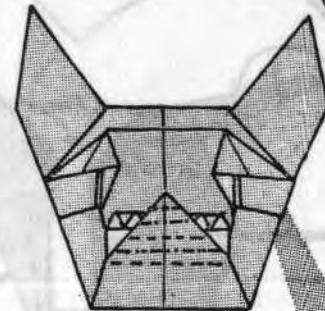
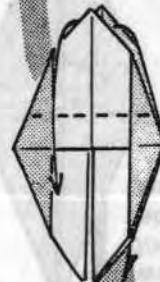
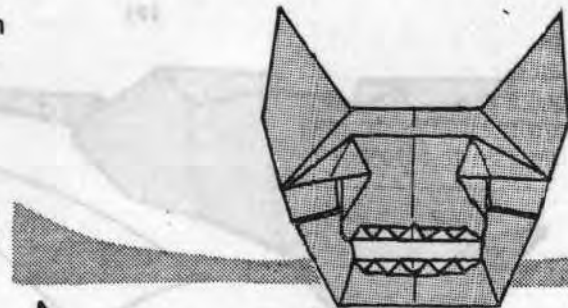
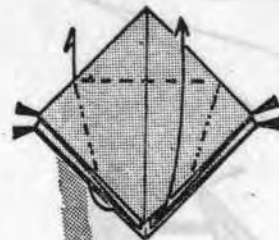

pleat
the
teeth

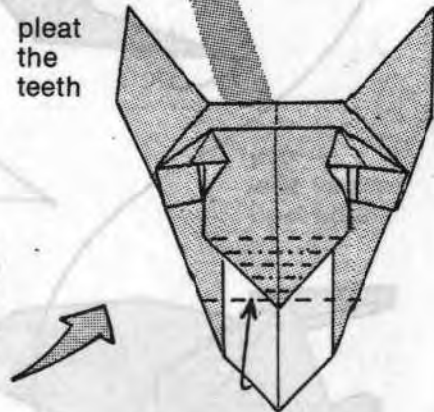
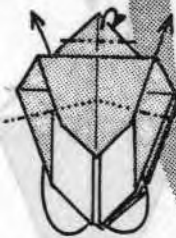

Polyhedral Box Dr. Roberto Morassi Italy

pre-crease a square as indicated some quite difficult folds are made inside and outside the box

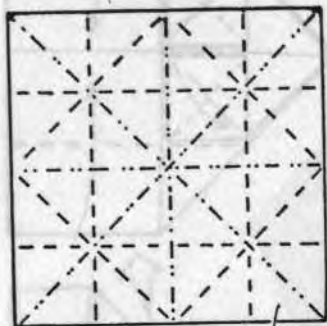

first examine the final drawing

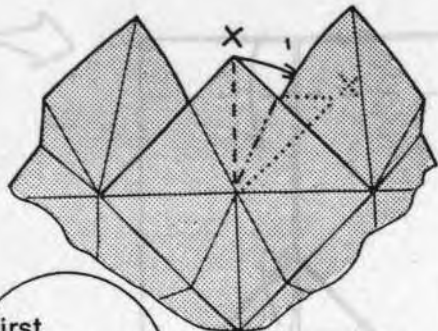

now work on one side at a time clockwise

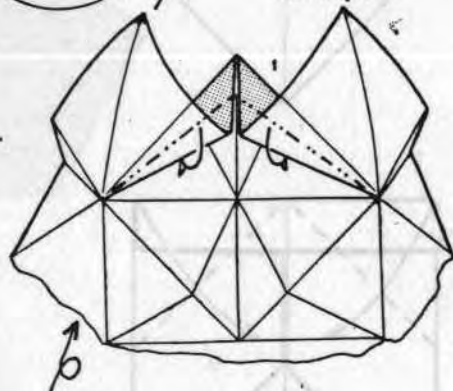
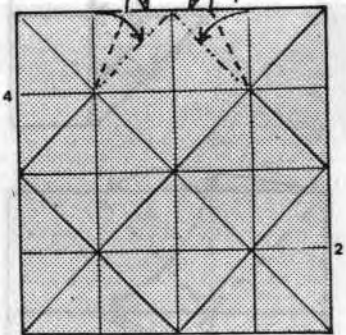

pre-crease the other three sides in the same way

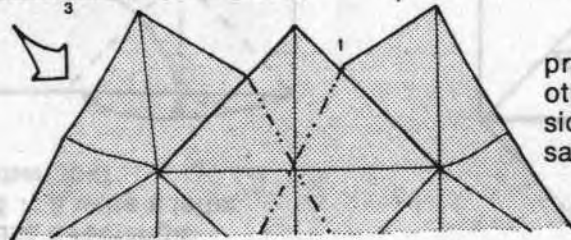

Polyhedral Box

Worth trying

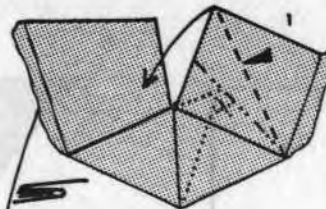

lock X with crimp pre-crease this flap on other three sides

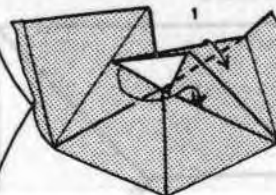

valley fold and tuck in pocket

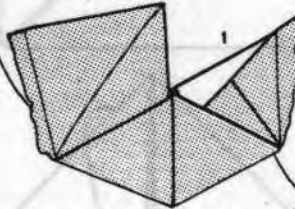

repeat folds with side two

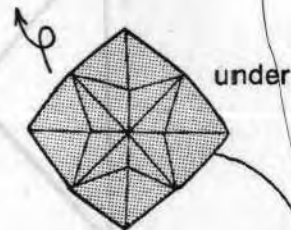
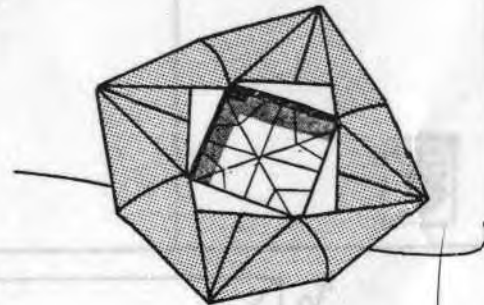

now repeat folds with three and four

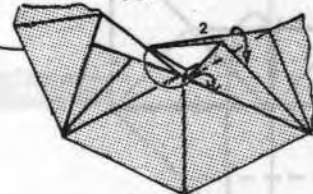

Post a Letter Sent by Gary Simpson

Gt. Britain

use a rectangle
4 x 3 write a letter
then fold - letters 1/4 - 1/2

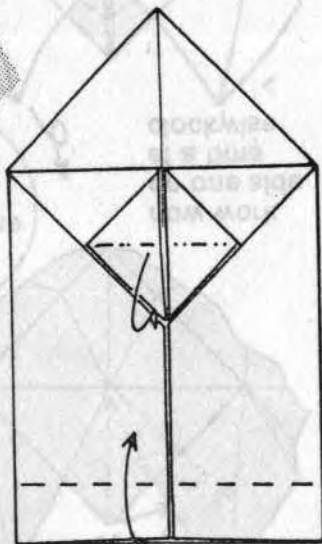
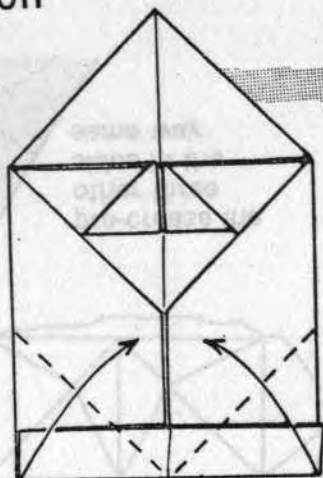
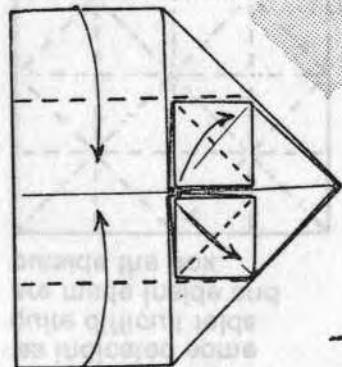
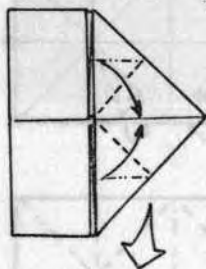
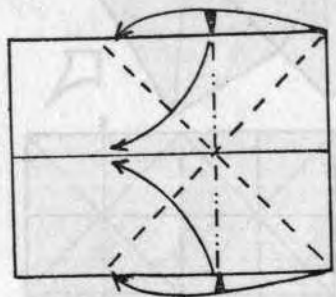

Post a Letter

This is practical

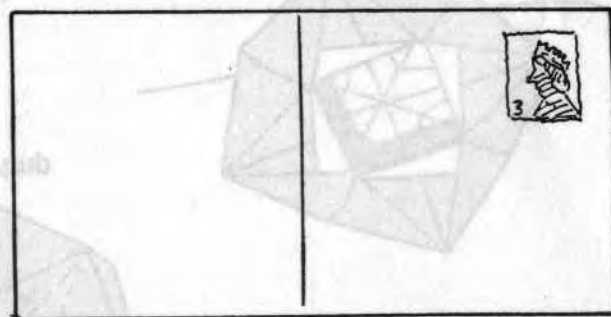
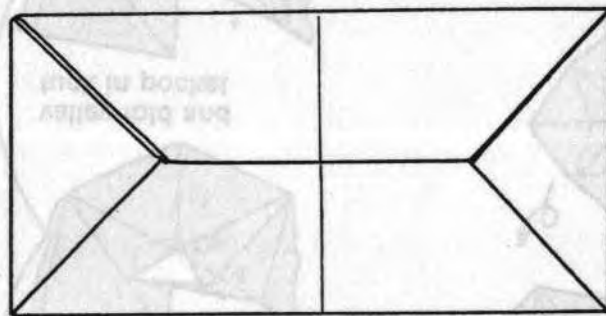
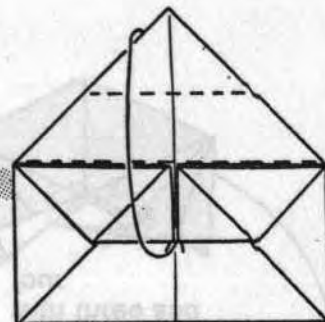
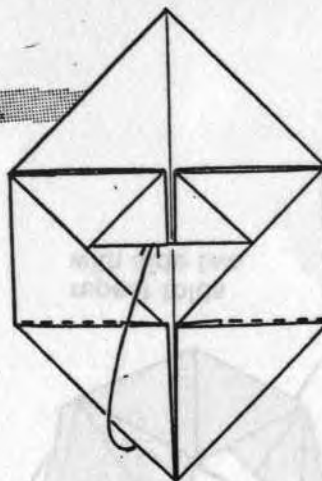

Cupid Ronald Koh

Singapore

rectangle 6 × 3
use gold foil

two squares
3 × 3 red one
side begin with
a bird base

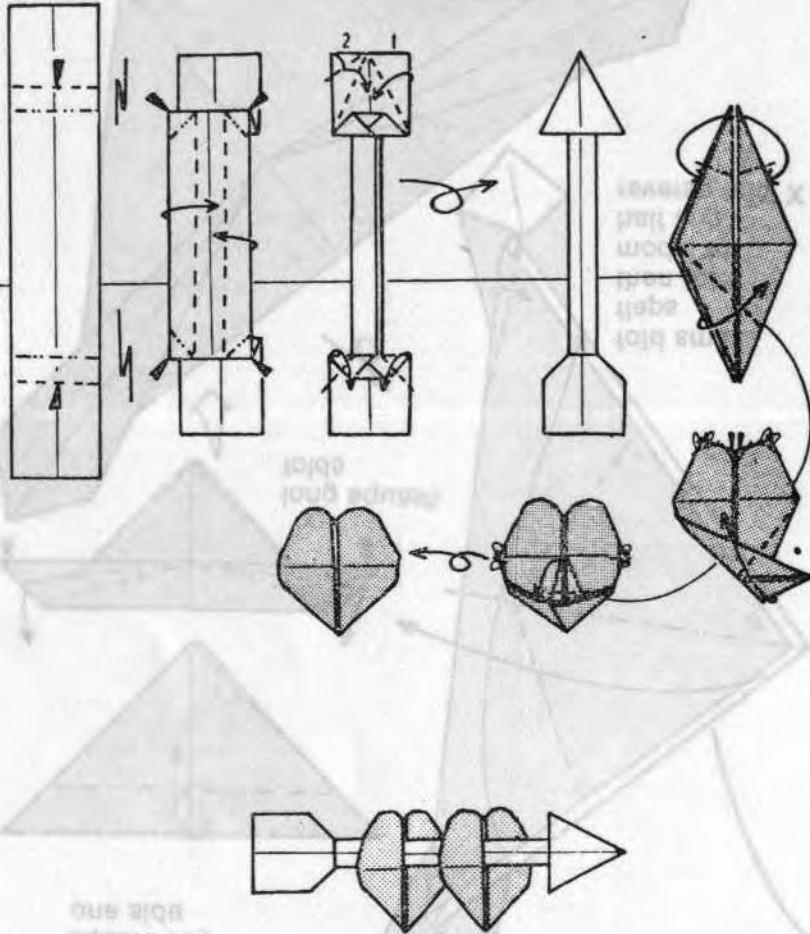

Blue Whale Stuart R. Allington Gt. Britain

a square blue one side
creased as shown
make the valley folds

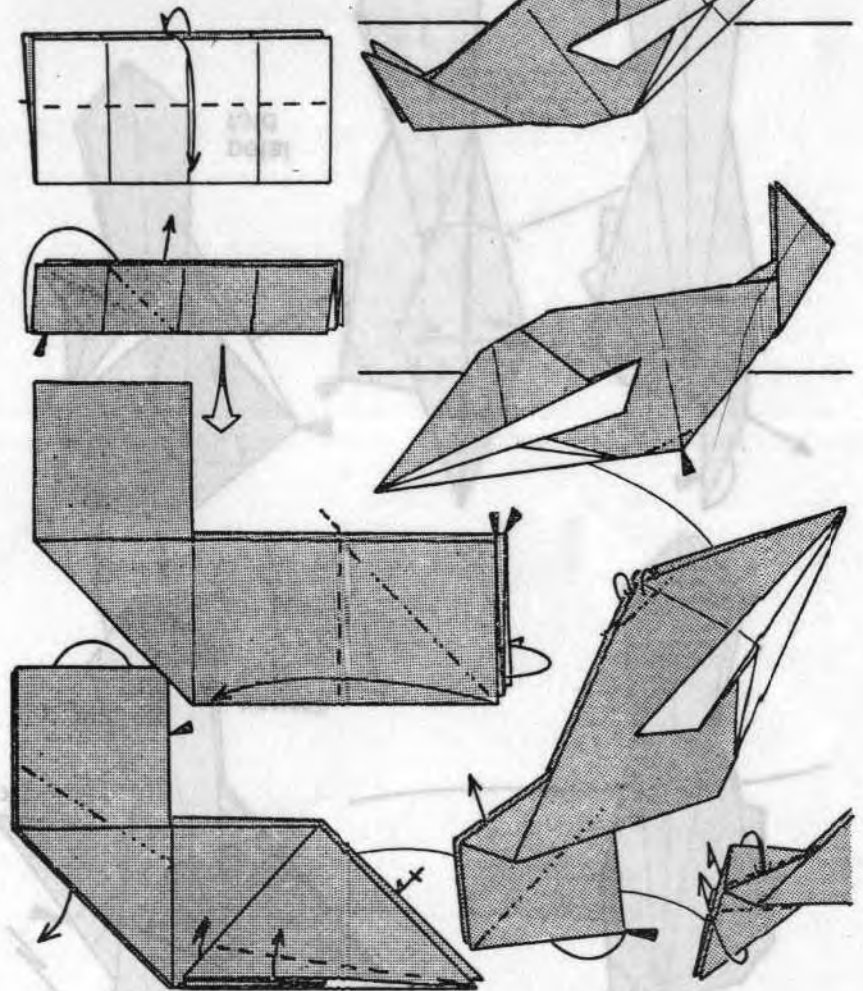

A Red Indian Edward Megrath , Gt. Britain

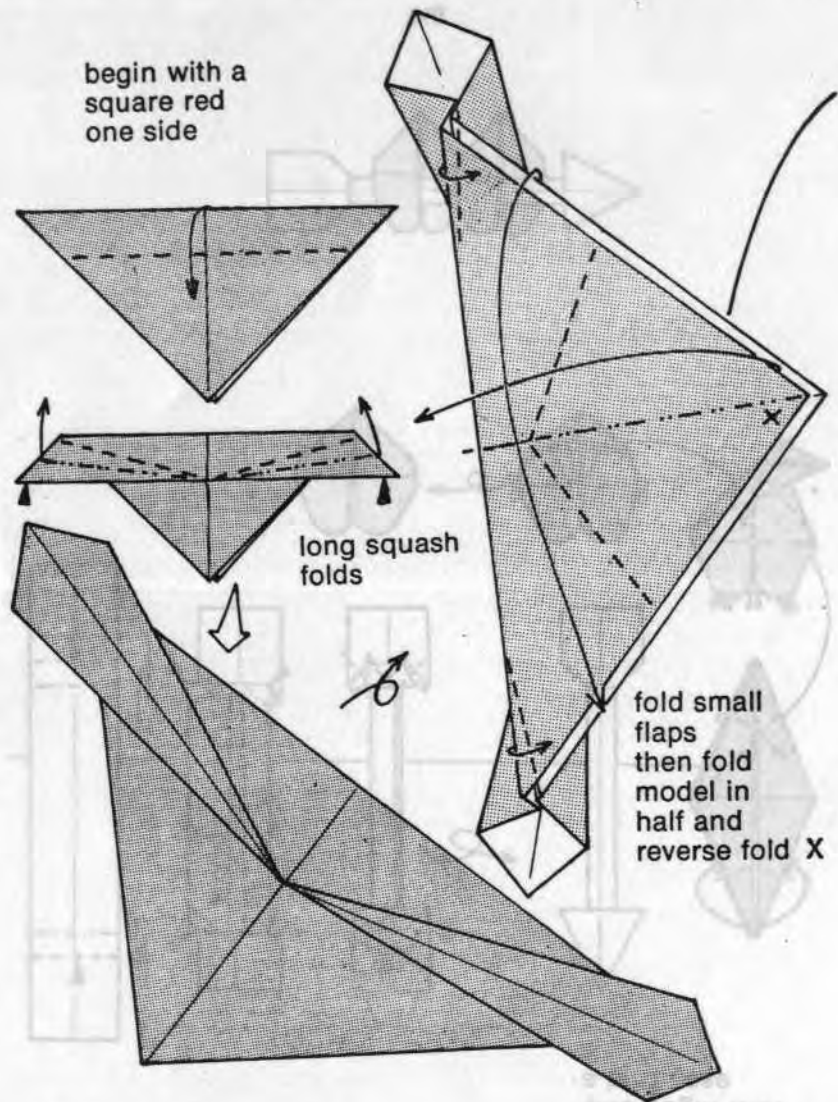

Red Indian concluded

How!

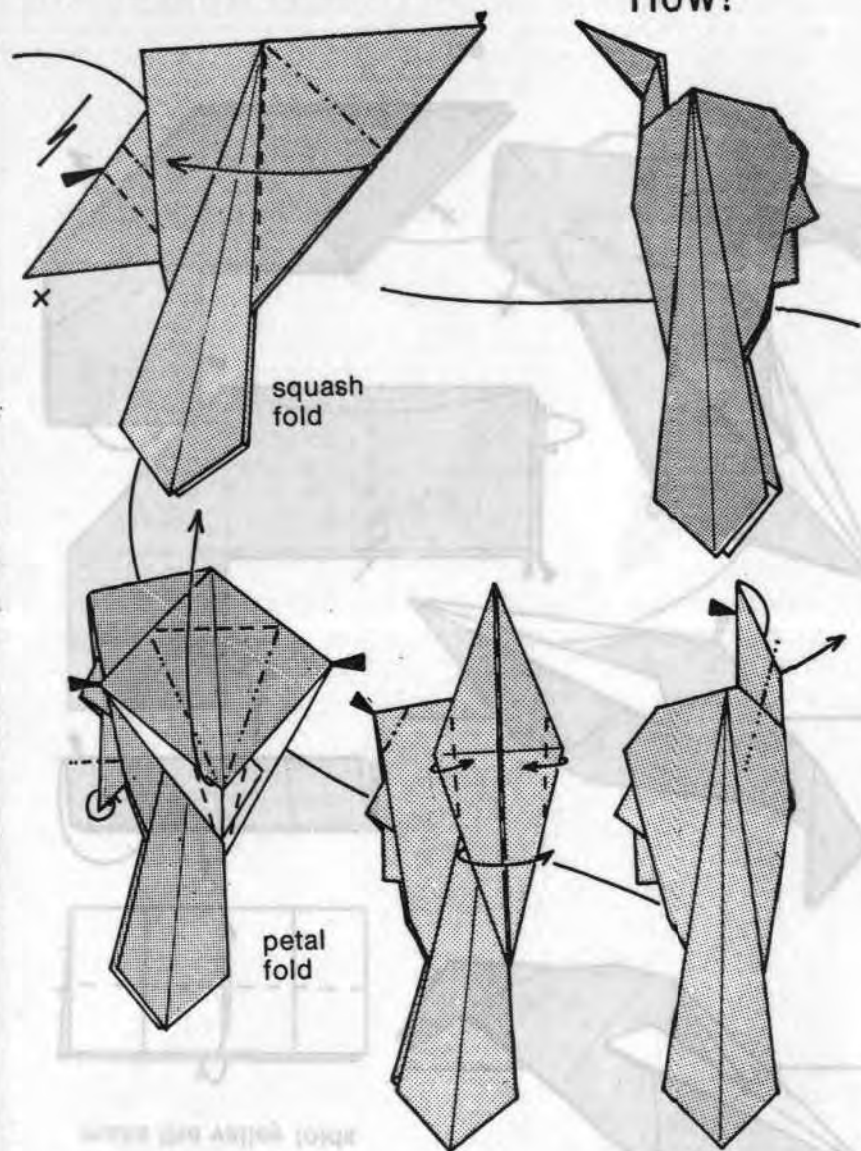

begin with a preliminary base

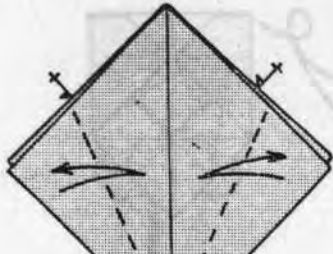

crease only

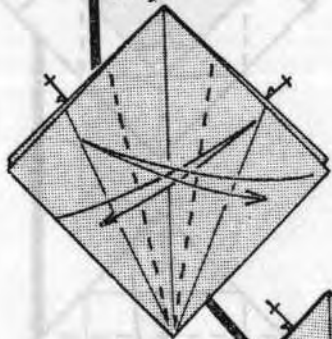

make four crimps

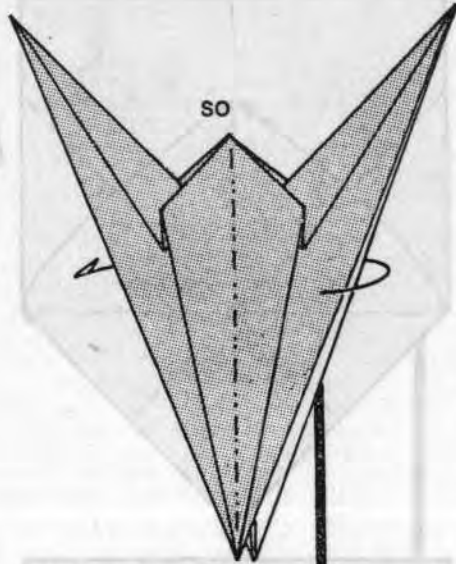
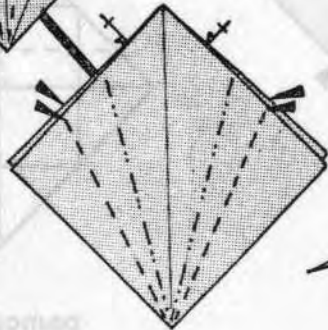

reverse fold points

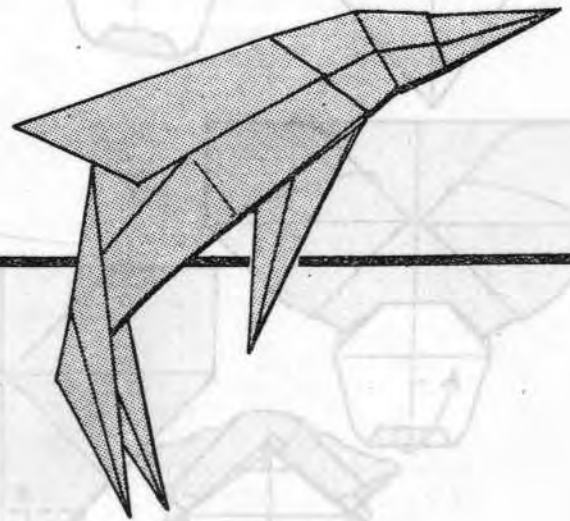
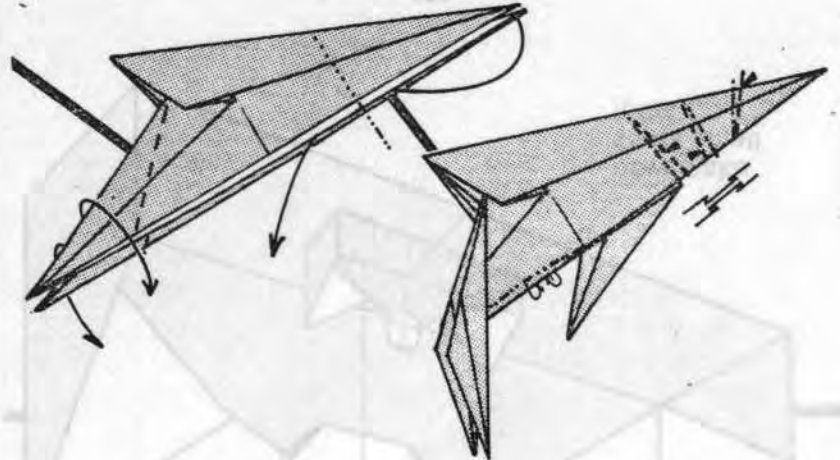
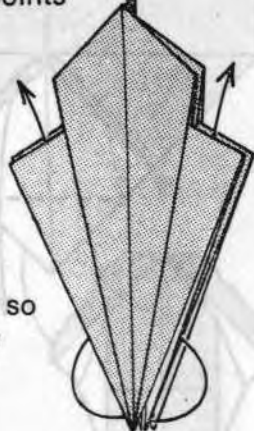

Buddah Display Robert Harbin Gt. Britain

use a large stiff square coloured one side

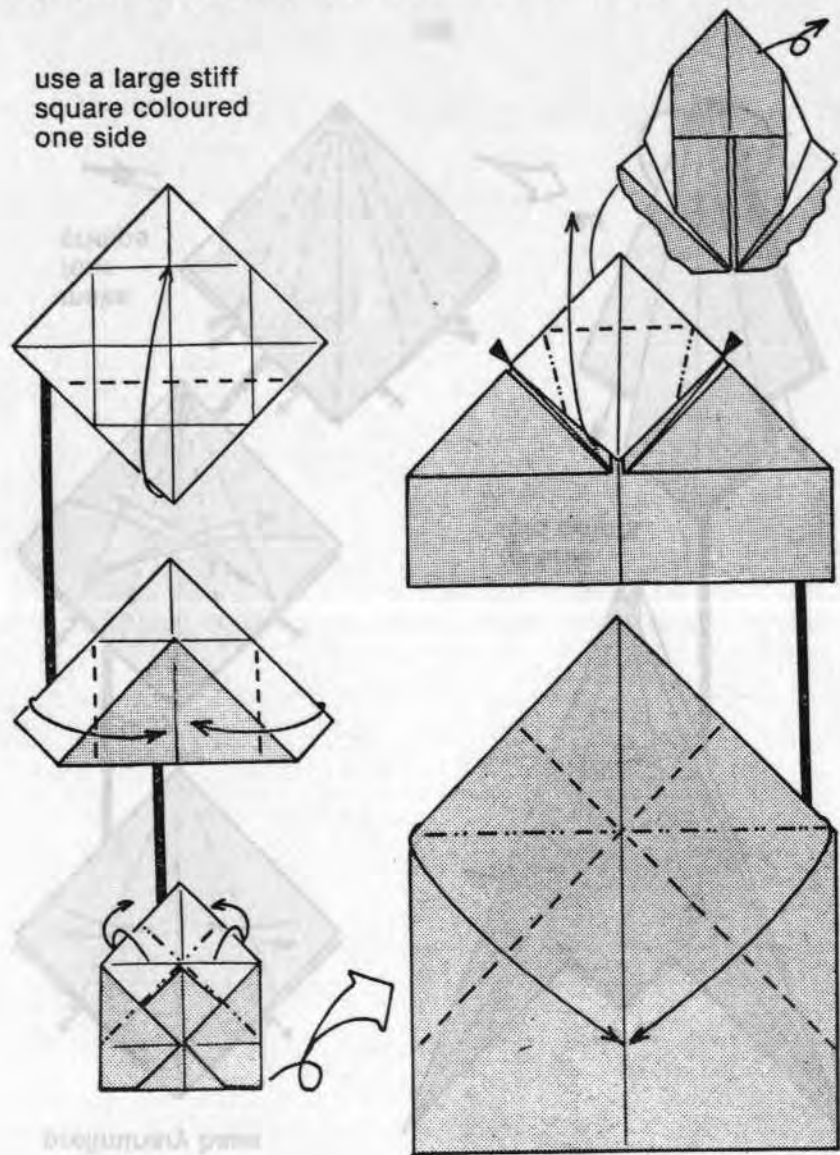

Buddah Display from Origami Compendium

No. 1

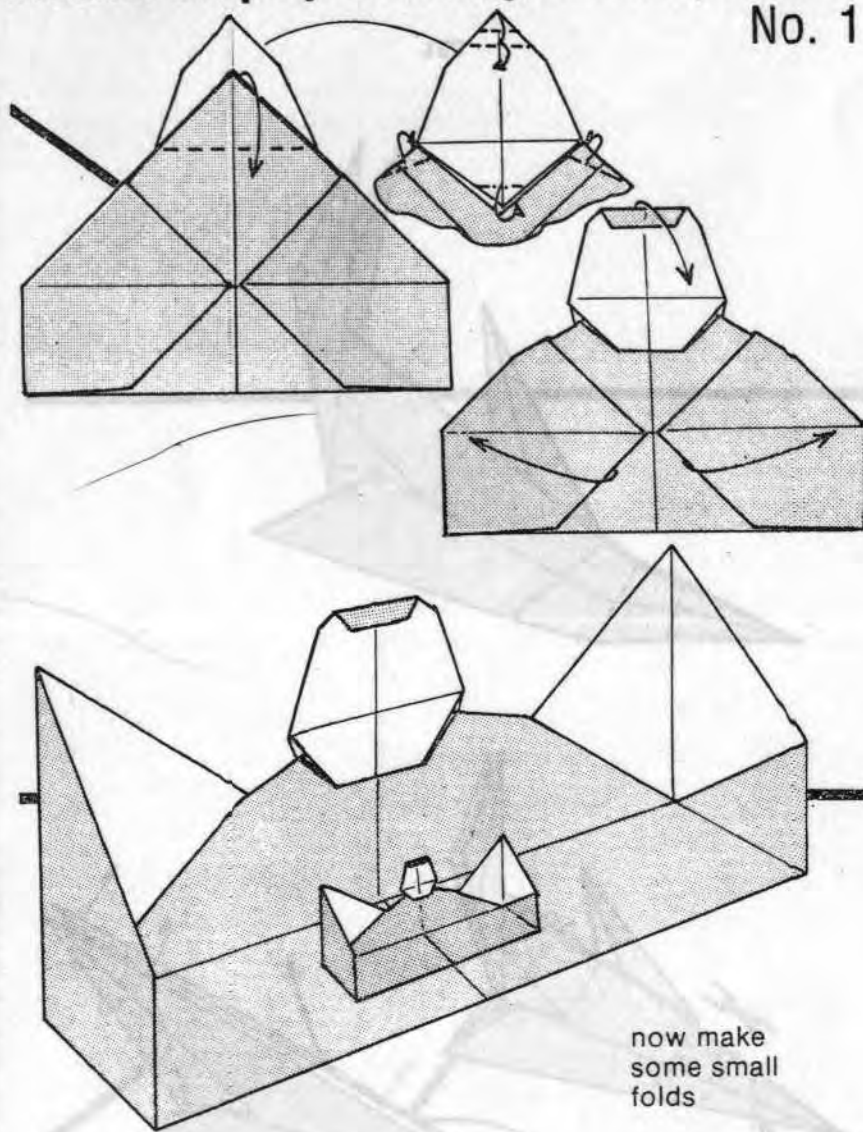

now make some small folds

Squirrel Alice Gray

use half a square
two rabbit's ears

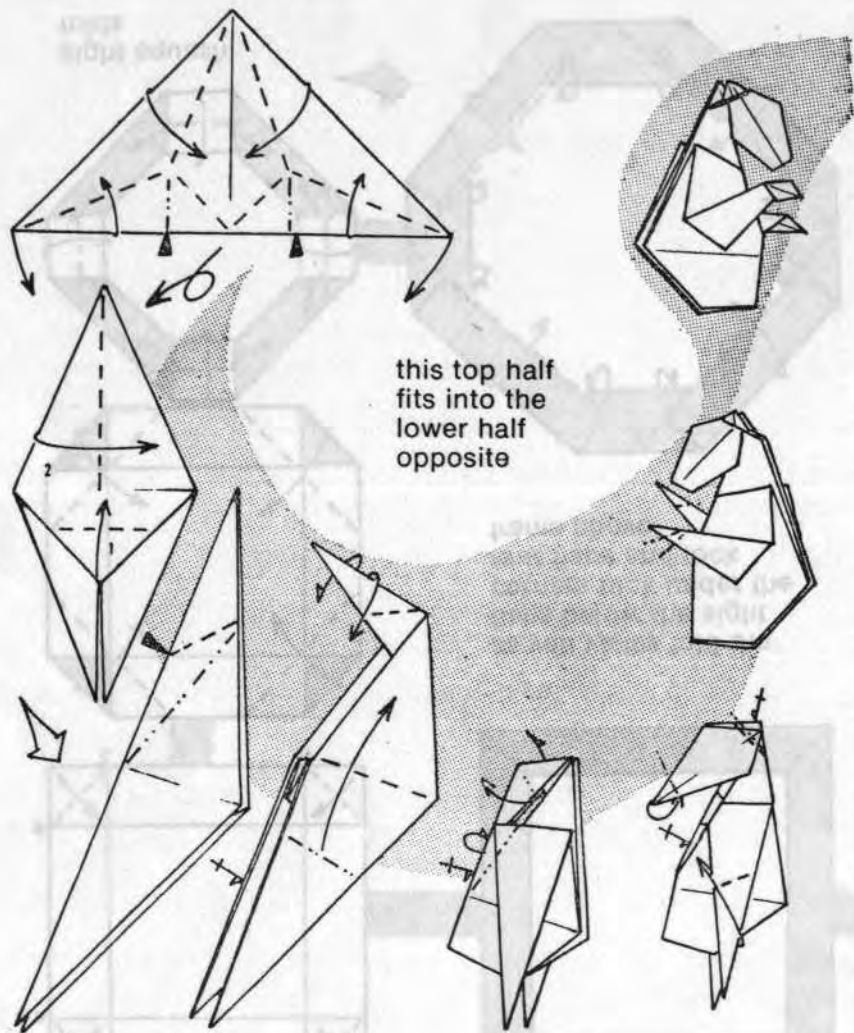

this top half
fits into the
lower half
opposite

U.S.A.

Squirrel concluded Ed Sullivan

U.S.A.

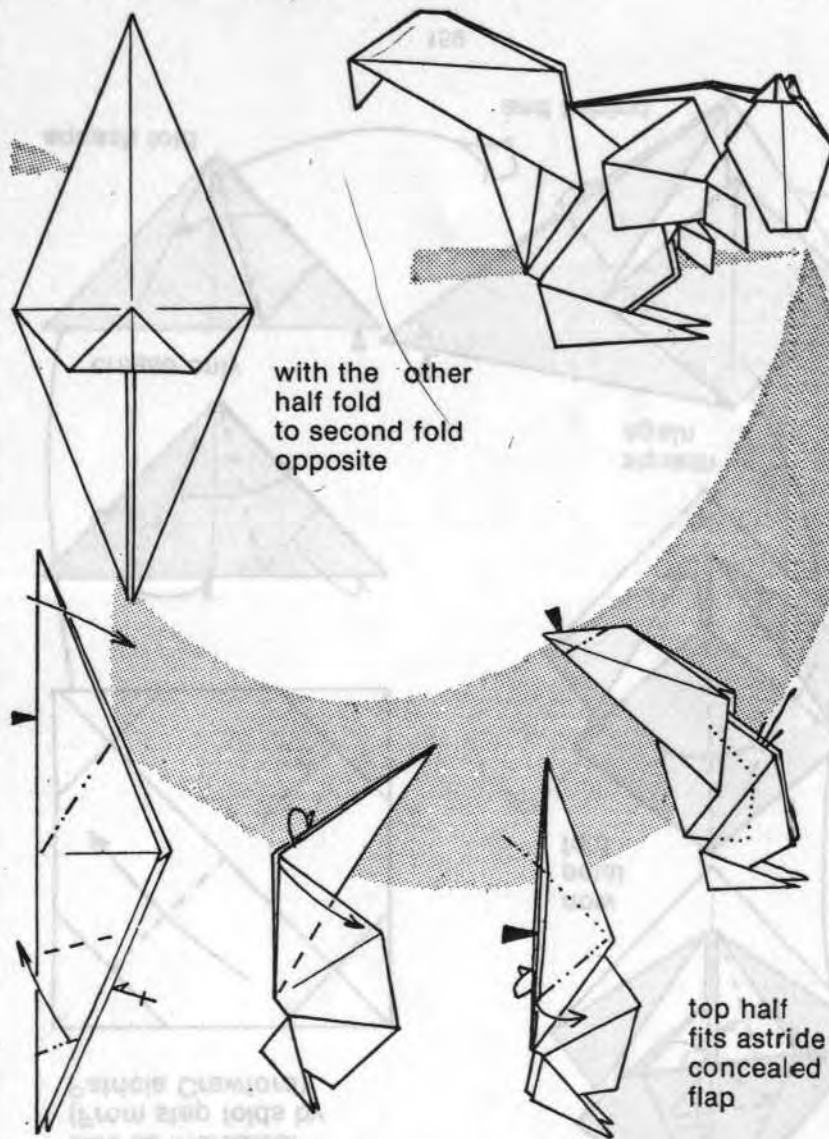

with the other
half fold
to second fold
opposite

top half
fits astride
concealed
flap

Picture Frame Ed Sullivan

U.S.A.

A, B, C and D are pencil lines
make frame any size you like

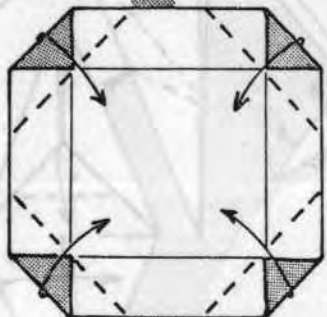
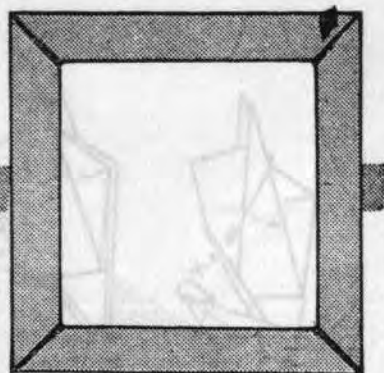
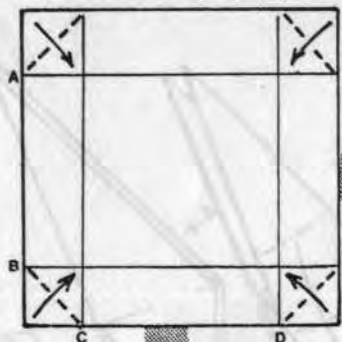

as you valley fold the
flaps below the eight
corners tuck under the
four flaps and lock
frame above

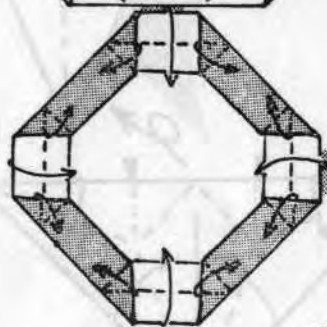

eight squash
folds

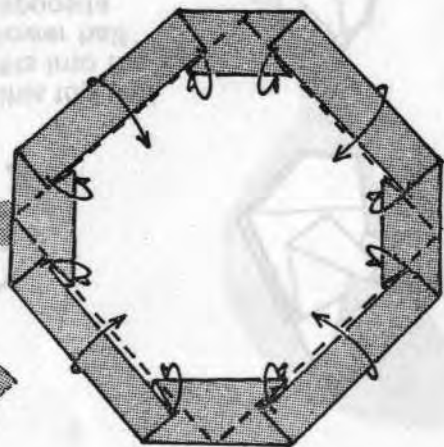

Four Roses Fred Rohm

U.S.A.

Use a square of gold
foil. Colour white
side as indicated.
(From step folds by
Patricia Crawford)

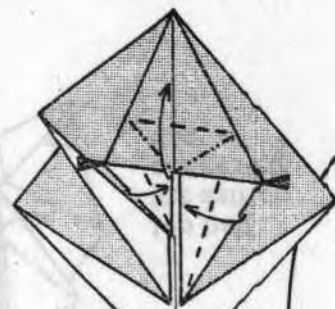
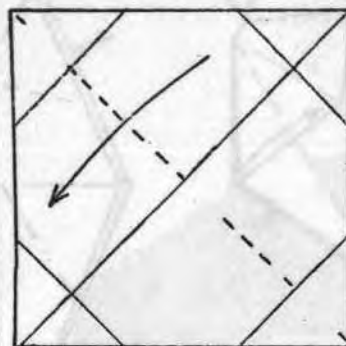

now
petal
fold

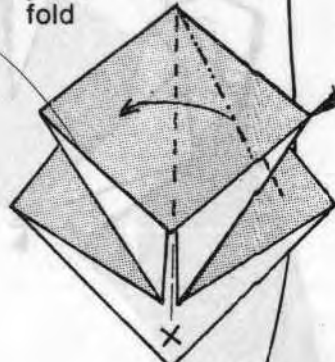

squash
again



crease only

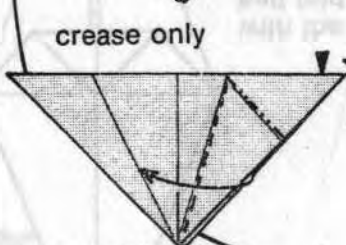

squash fold

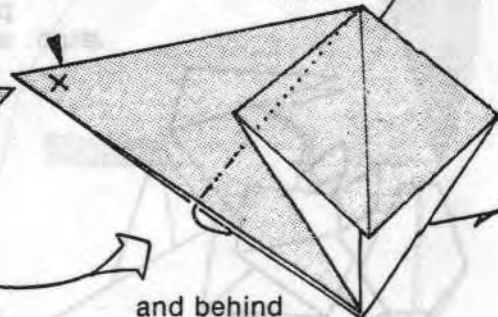

and behind

Four Roses Watch for the colour changes

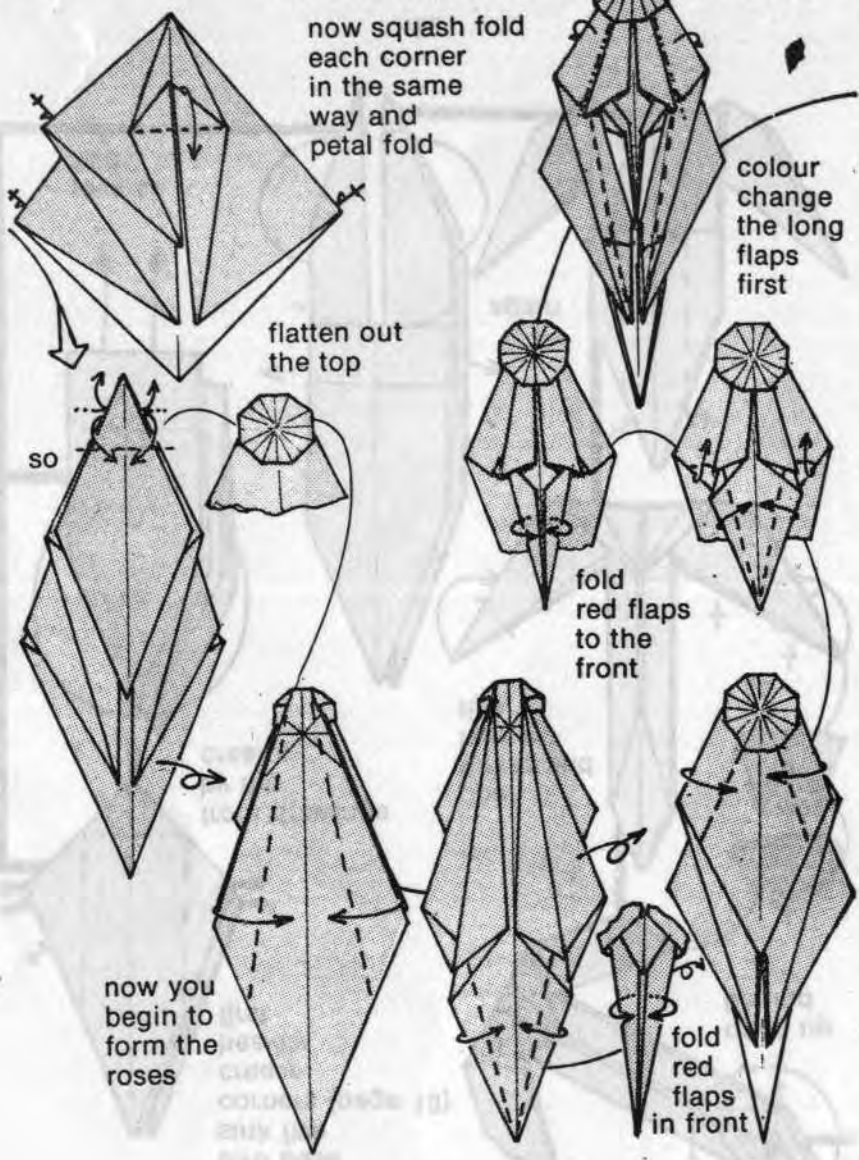

Four Roses Not as hard as it looks

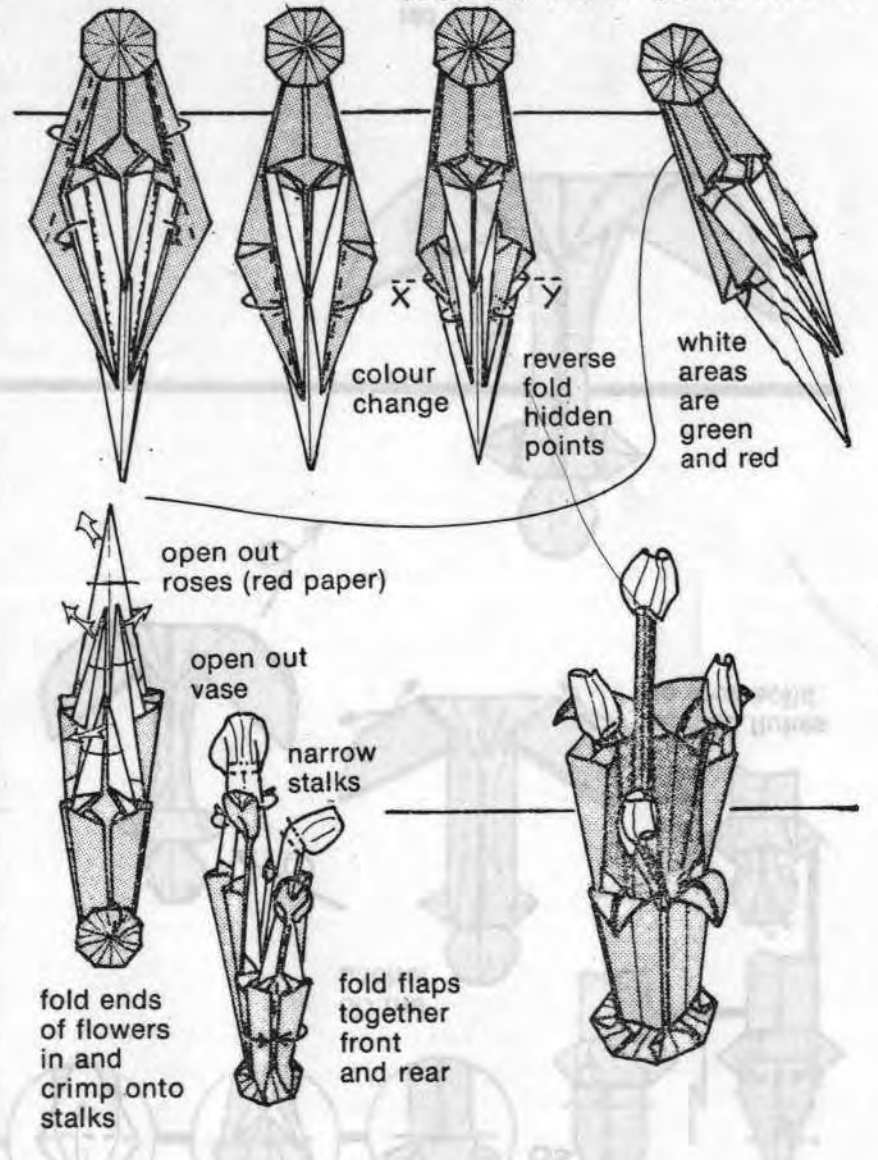

Anchor Ted Darwin

Gt. Britain

begin with a bird base sink five corners (page 16) crease heavily first

from drawings by the creator

open flukes and fold in tips

again

reverse fold

open up behind

so

Anchor concluded

3D the anchor

rear view

spread flukes to look solid

Ocean Liner Ted Darwin

Gt. Britain

use a square
coloured one side
From drawings by
the creator

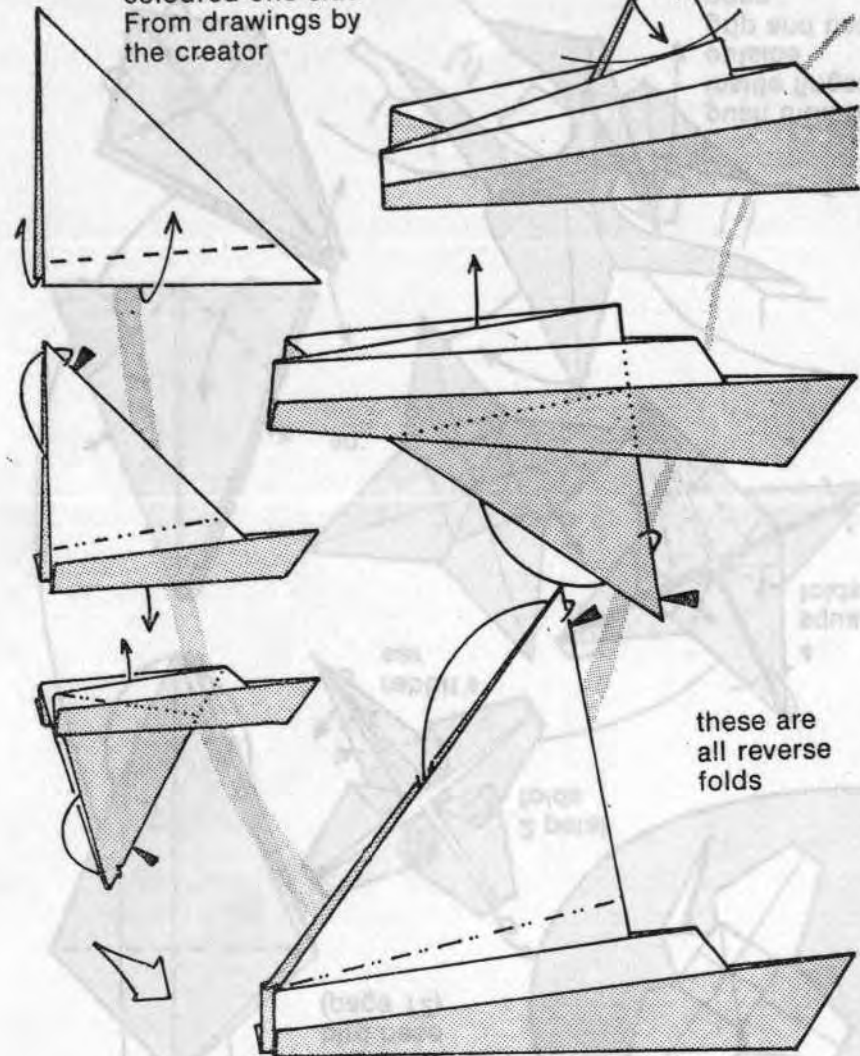

these are
all reverse
folds

Ocean Liner concluded

Very neat

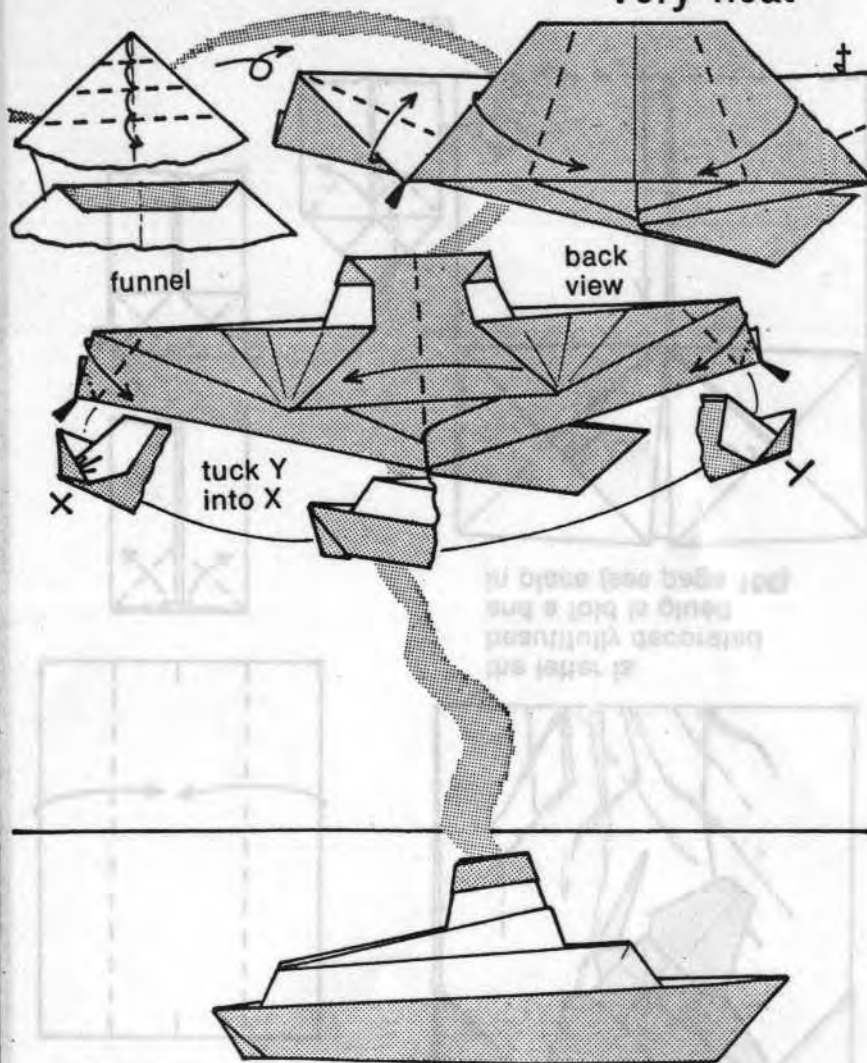

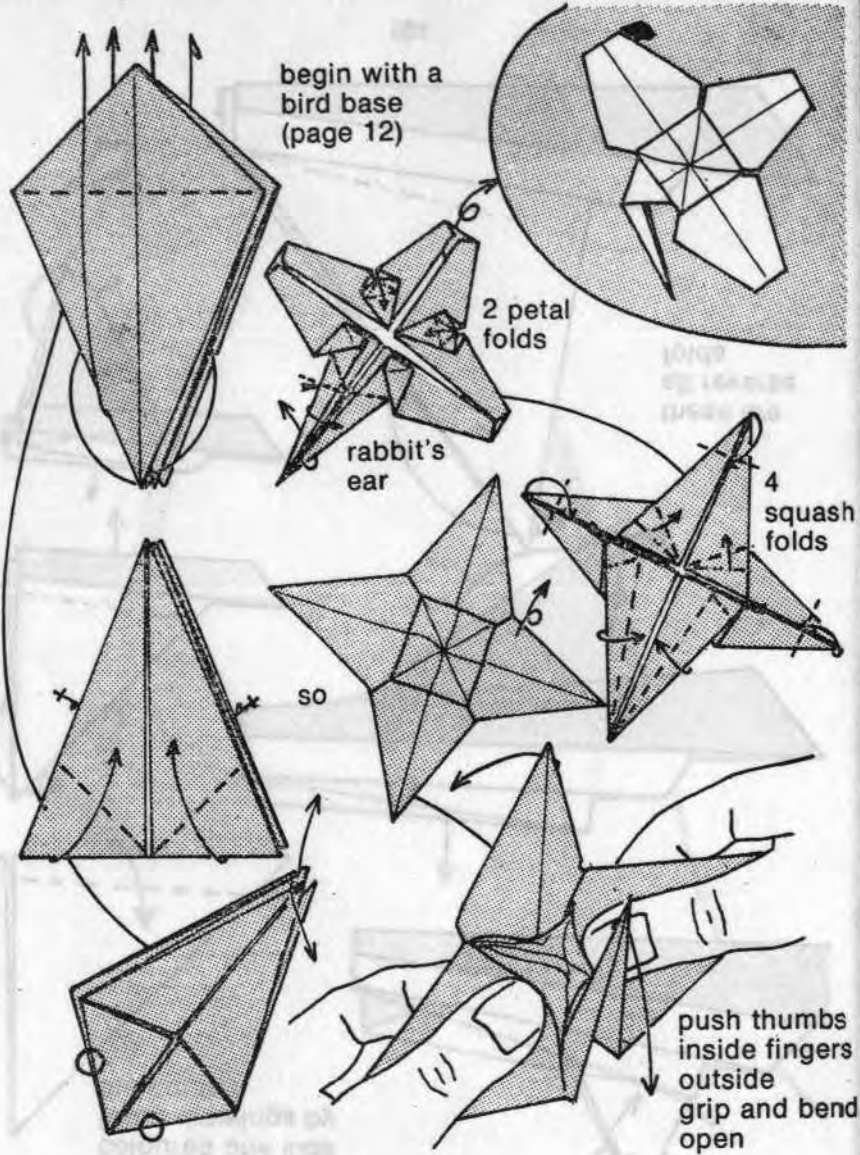

begin with a bird base (page 12)

2 petal folds

rabbit's ear

4 squash folds

so

push thumbs inside fingers outside grip and bend open

a sheet of note paper folded as indicated

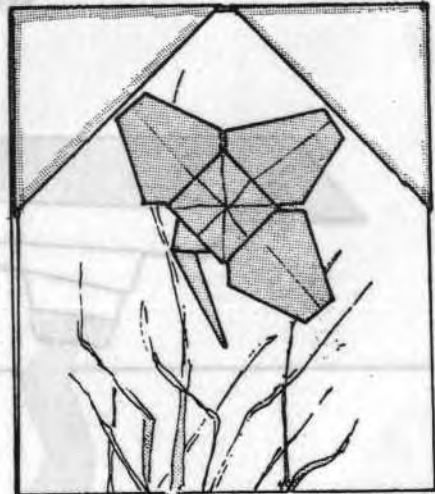
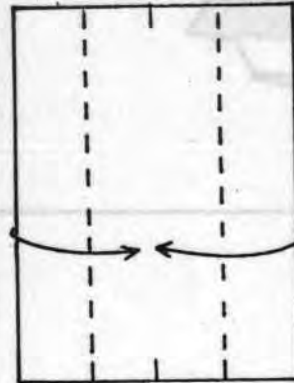

the letter is beautifully decorated and a fold is glued in place (see page 166)

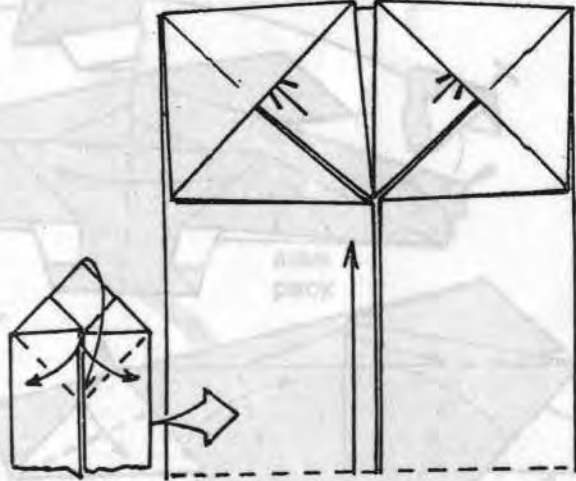
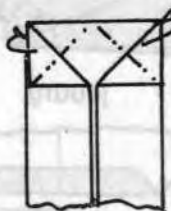

Angel Fish Dale Walton

U.S.A. Angel Fish

Such a clever fold

use a ~~fish~~ ^{bird} base
(page 118)

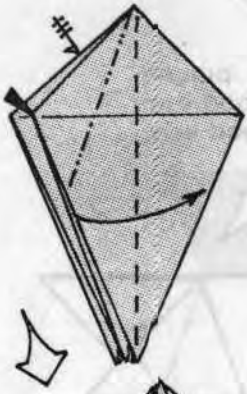

fold single layer right and flatten corner

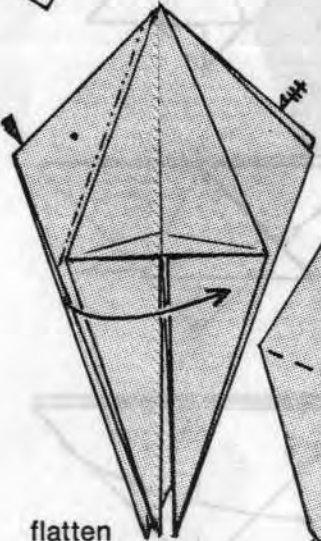

flatten again then twice more

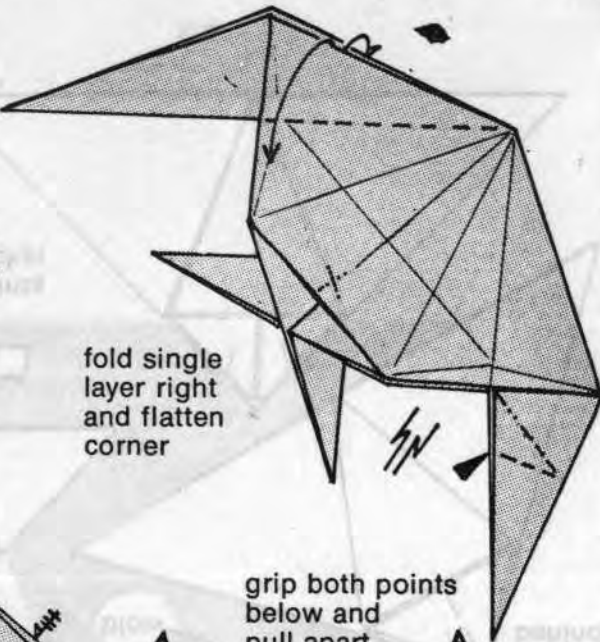

grip both points below and pull apart X will go inside front and behind

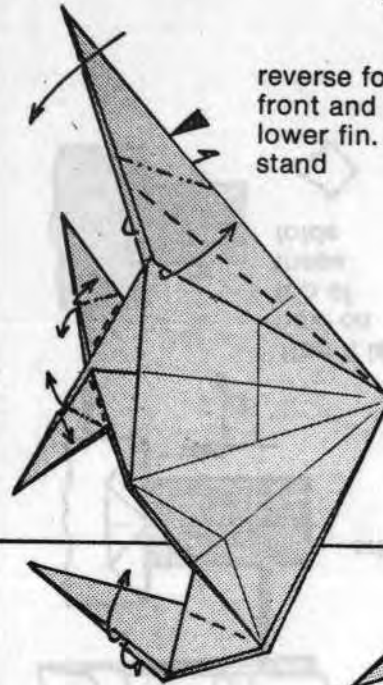
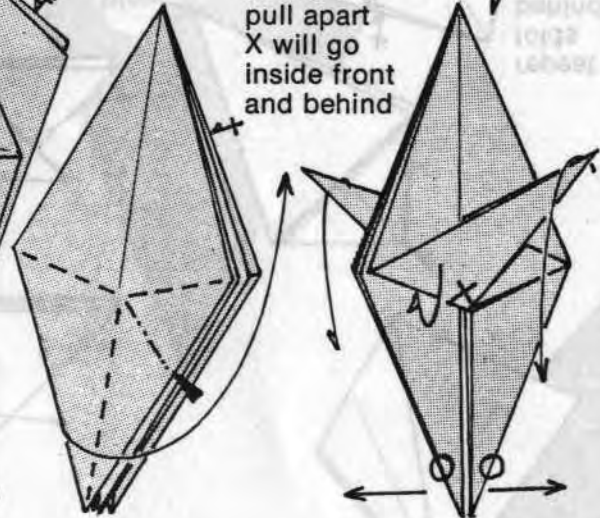

reverse fold fin tip. Valley fold front and rear. Open out tail fins. Open out lower fin. Model will stand

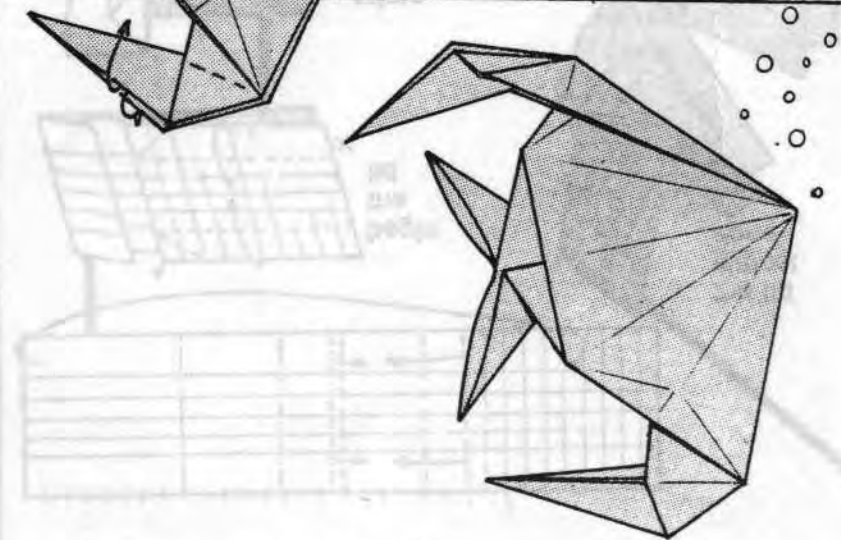

Pyramid Bobby Valkenburg New Zealand

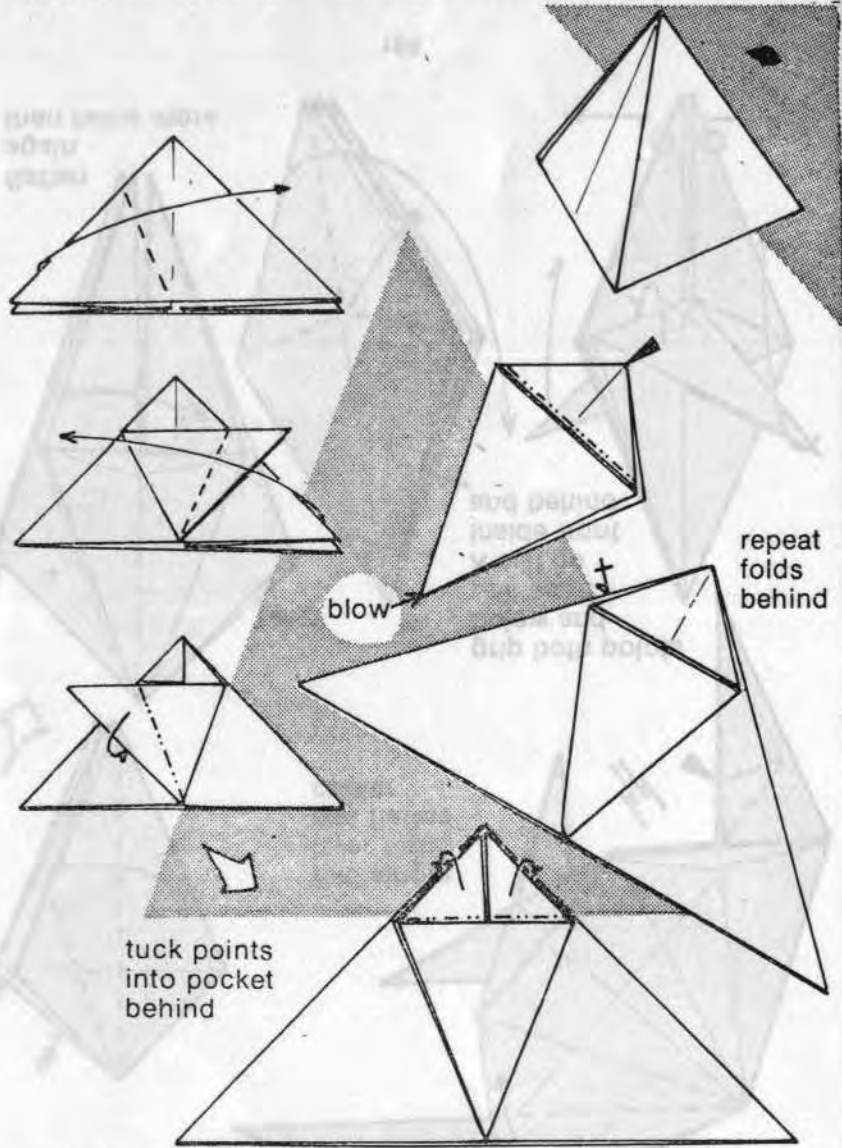

170

Flip-Top Dave Brill

Gt. Britain

use a rectangle of patterned foil 12 x 48cms. Crease carefully as indicated and then make a mountain fold and two crimps.

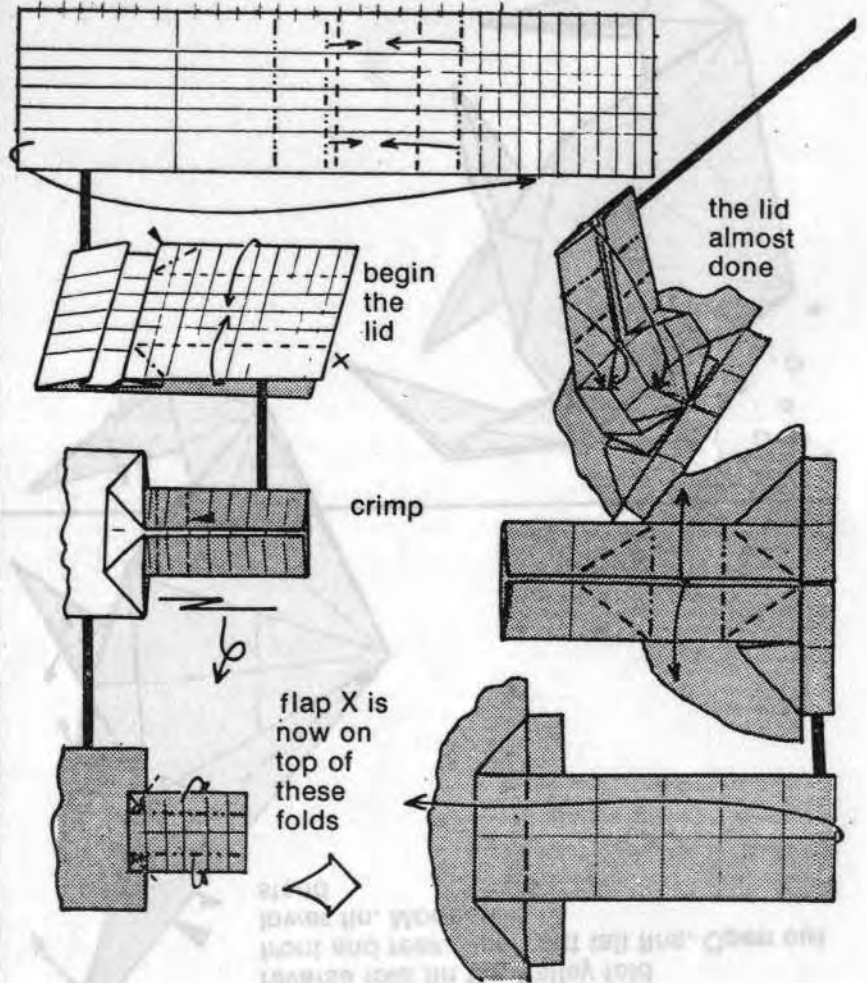

171

Flip-Top continued

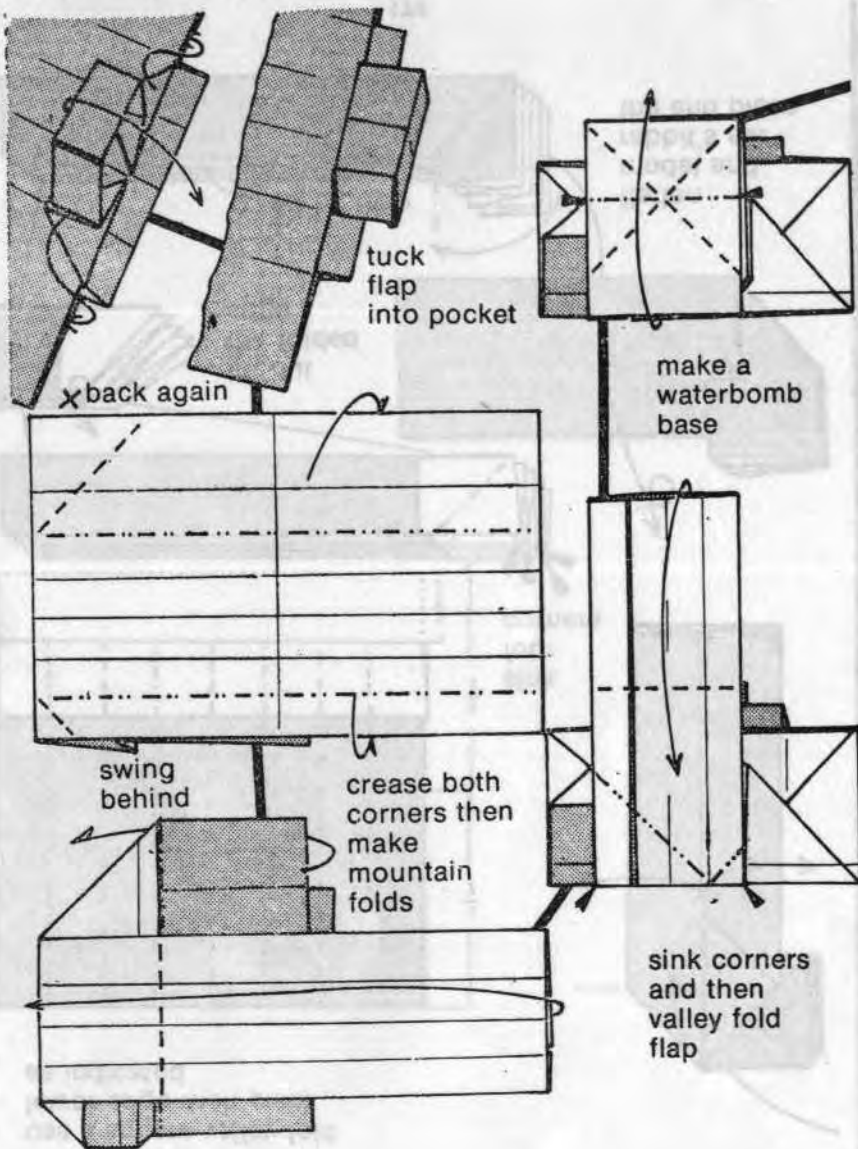

Flip-Top concluded

Real magic

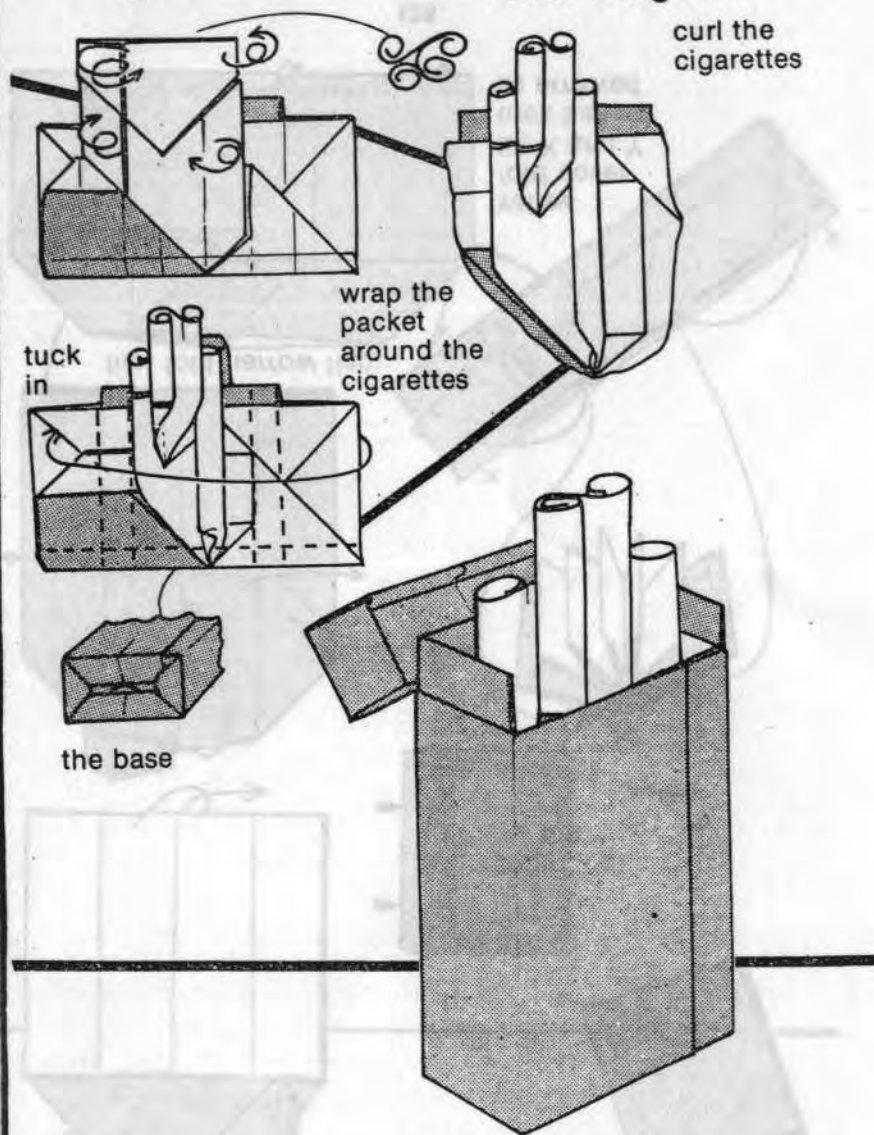

Book Dave Brill

Gt. Britain

use a square valley fold
lower edge then pleat
as indicated

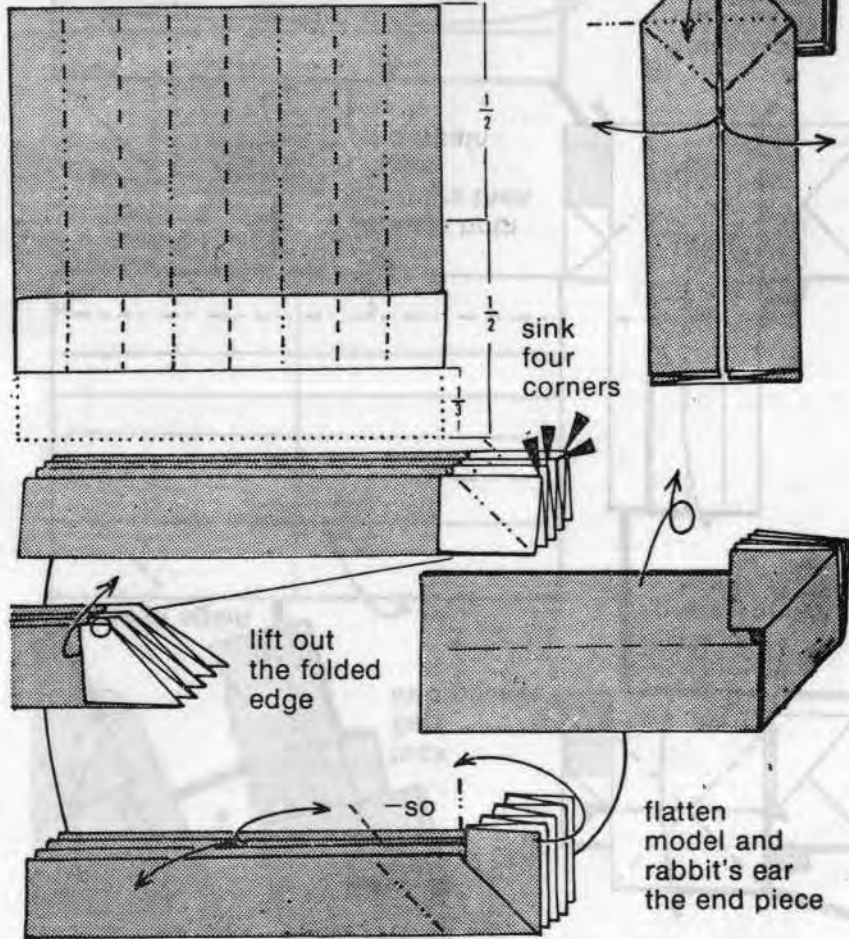

Book concluded

Really different

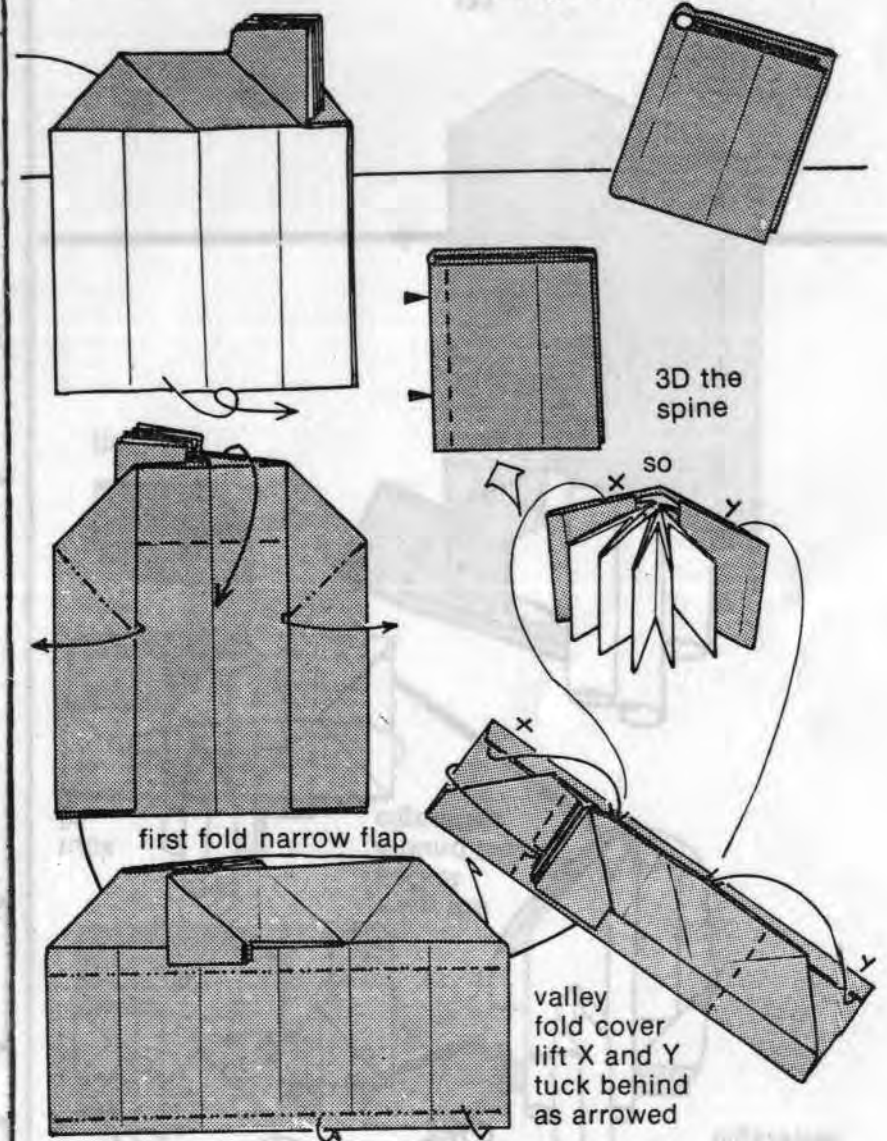

Tipper Truck Max Hulme

Gt. Britain

Tipper Truck continued

Concentrate here

use a 3 × 1 rectangle
crease as indicated
and then fold as shown

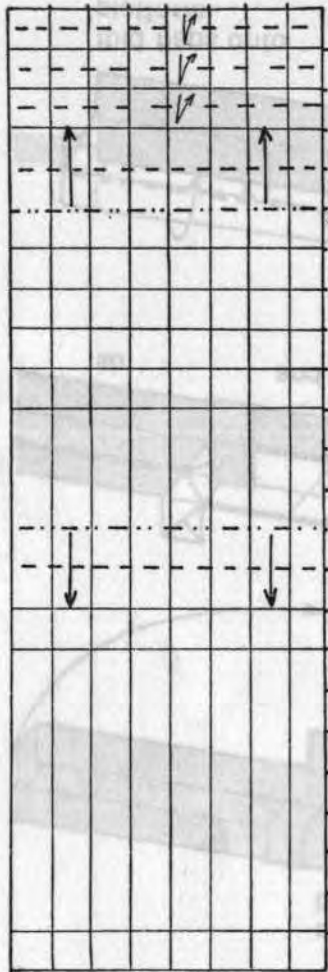

all the creases
make the model
fall easily into
shape

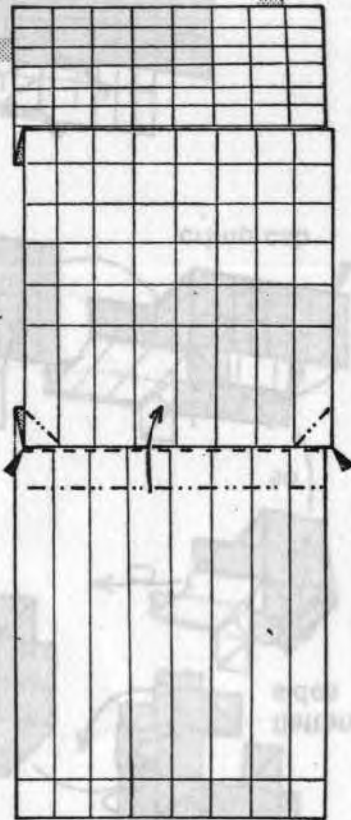

from illustrations
by Dave Venables

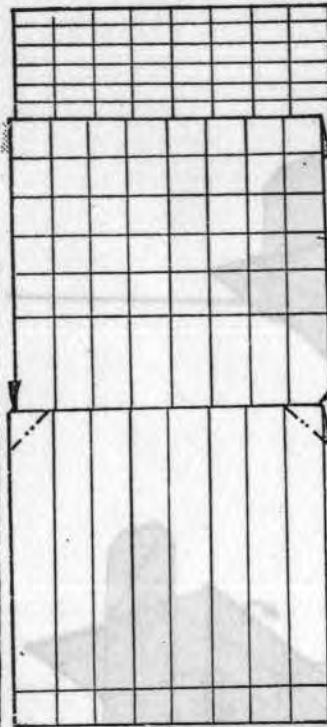

pre-crease
carefully
and then
fold into
shape it
is easier
than it
looks

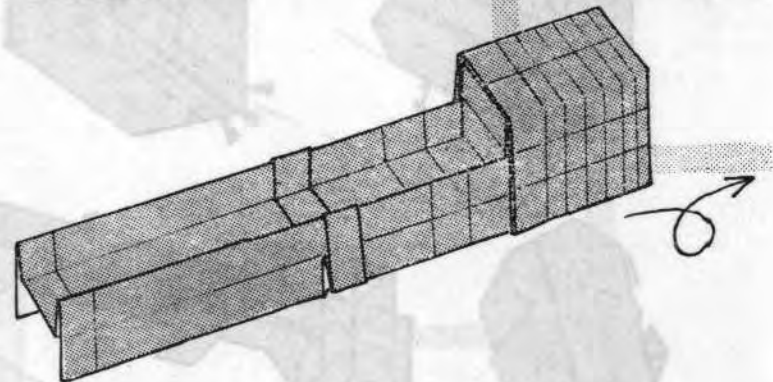
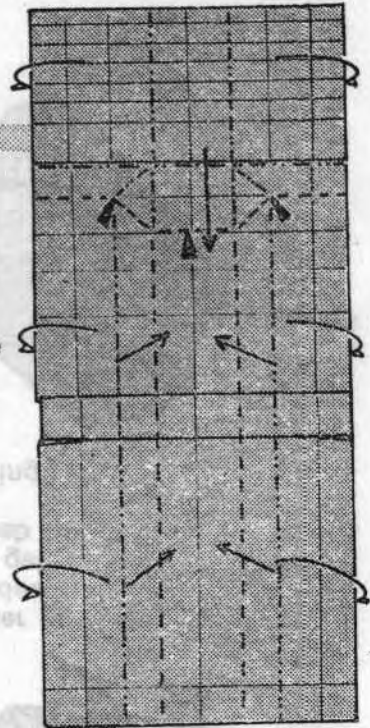

Tipper Truck continued

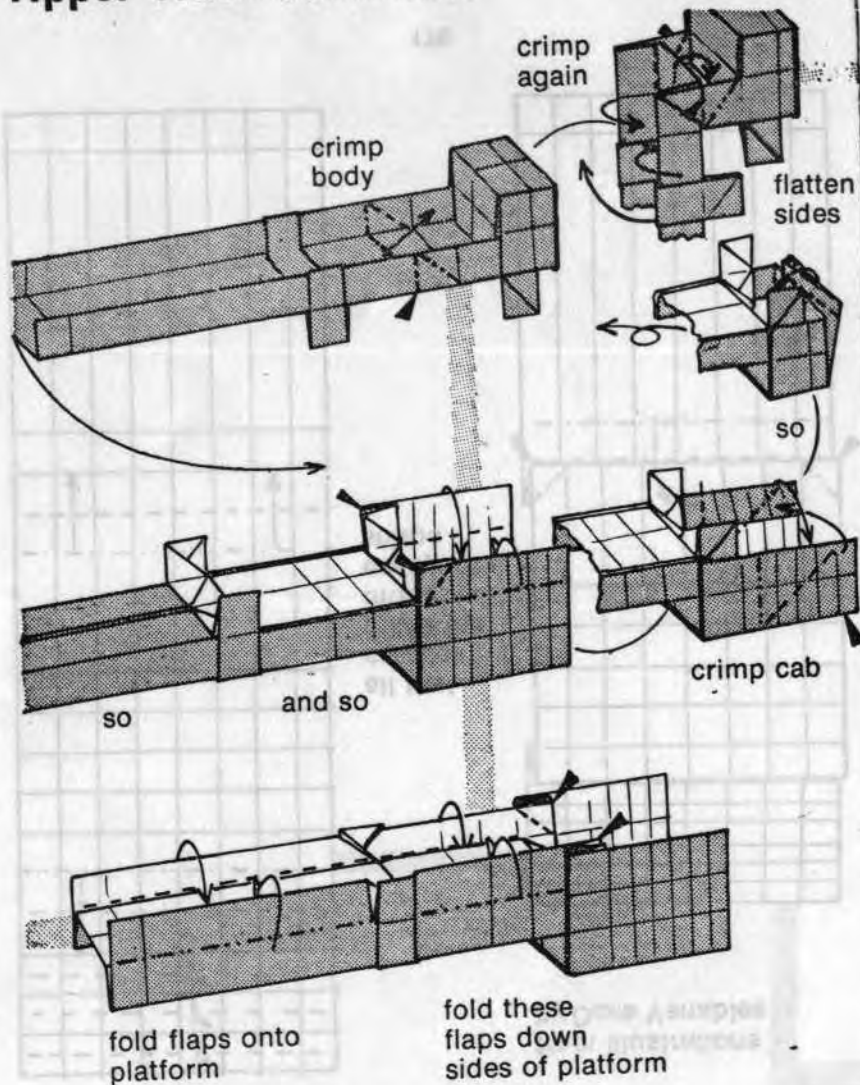

Tipper Truck concluded

Phew!

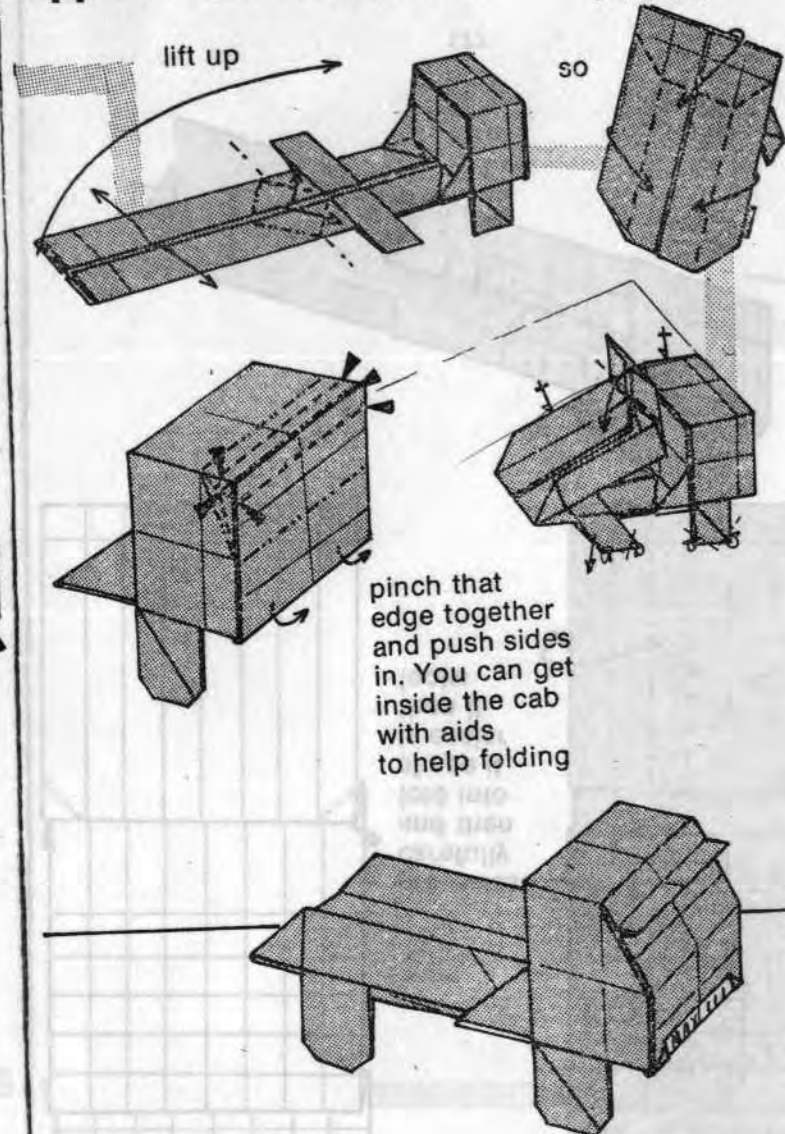

Matchbox 2 Max Hulme

use a 2 x 1 rectangle
colour side up. Crease
as indicated valley fold

Gt. Britain

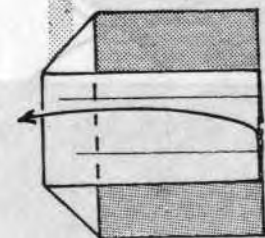
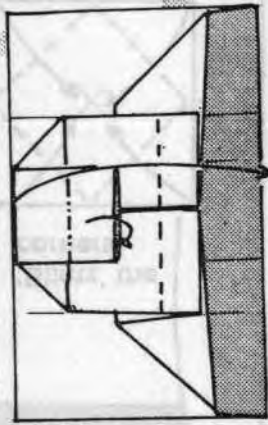
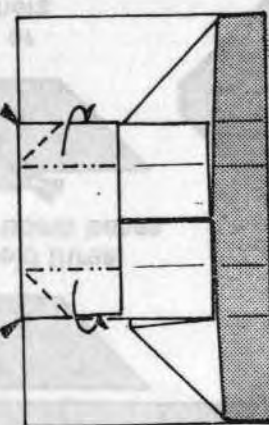
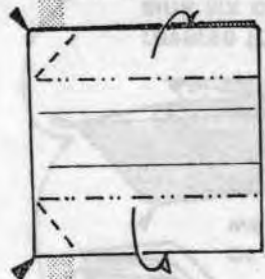
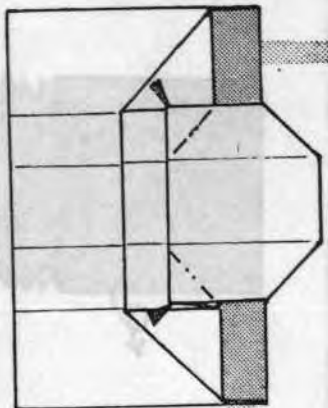
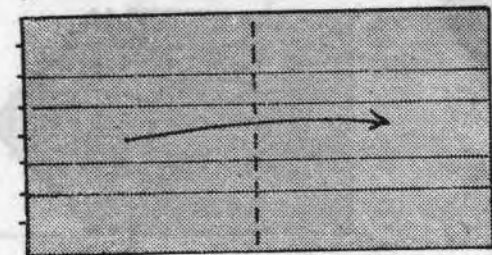

from illustrations
by Dave Venables

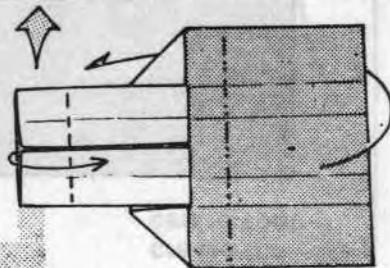

Match Box 2 concluded

Clever stuff!



sink sides
of tray

so

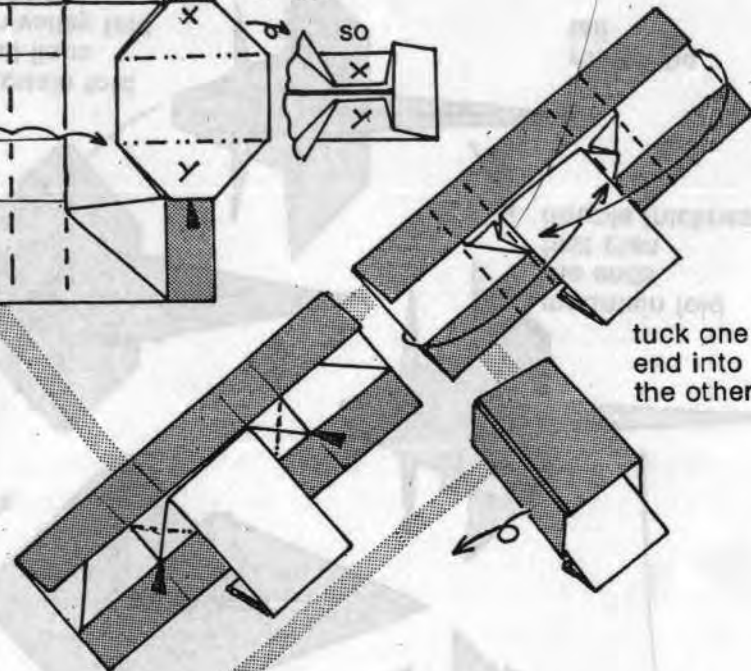
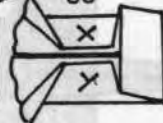

tuck one
end into
the other

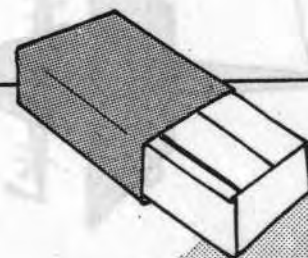
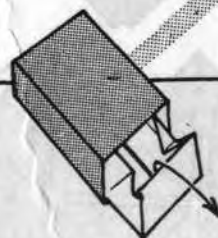

Lizard Max Hulme

Gt. Britain

begin with a rectangle of foil
4 x 1 gold or realistic colour.
Pleat as indicated

crease for
centre spot

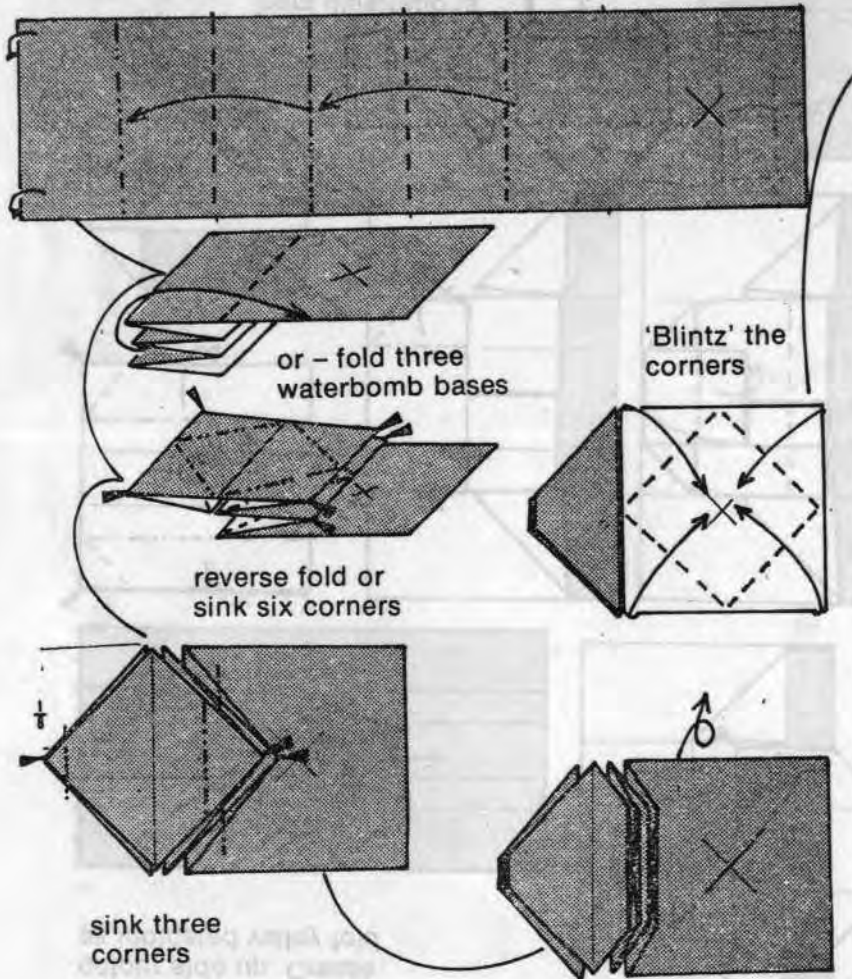

Lizard continued

rabbit ear
the front
legs

from illustrations
by Dave Venables
and Max Hulme

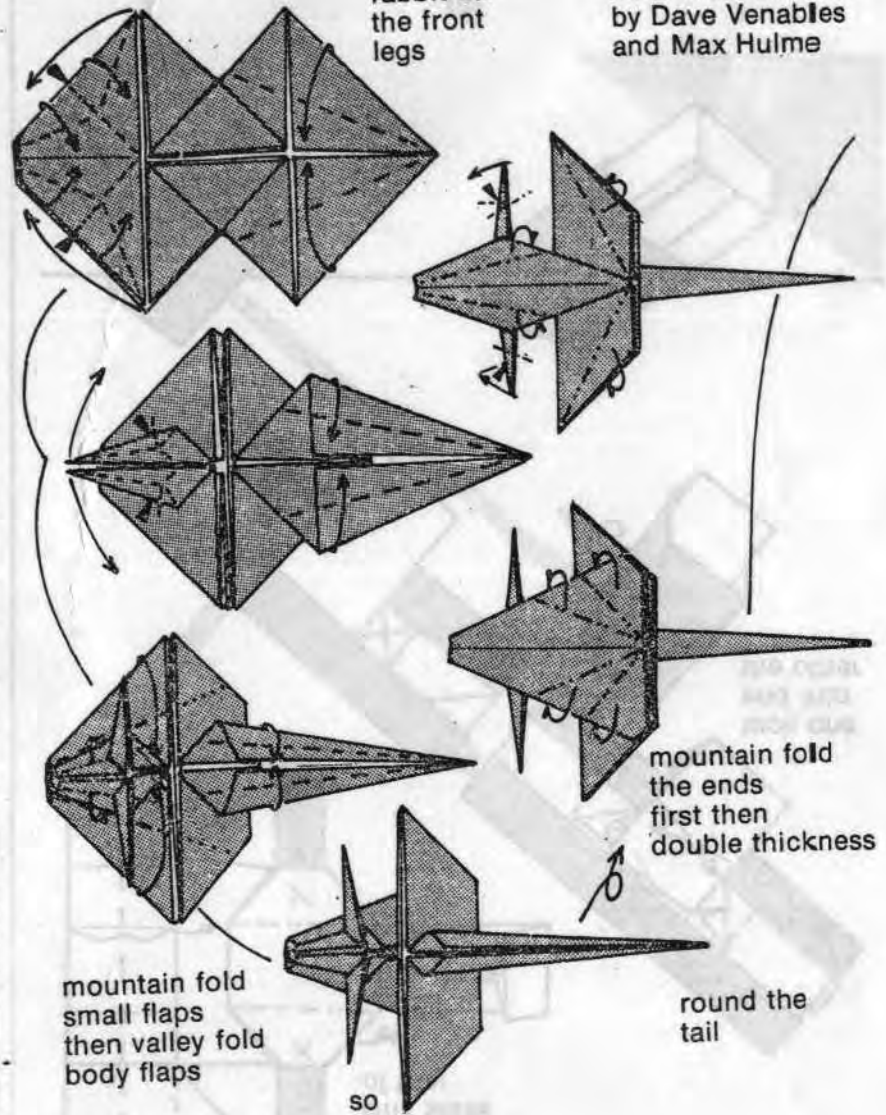

Lizard concluded

Another great fold

